

Power Choke Coil (Automotive Grade)

Series: **PCC-M0530M (MC) PCC-M0540M (MC)**
PCC-M0630M (MC) PCC-M0645M (MC)
PCC-M0754M (MC) PCC-M0750M (MC)
PCC-M0854M (MC) PCC-M0850M (MC)
PCC-M1054M (MC) PCC-M1050M (MC)
PCC-M1050ML (MC) PCC-M1060ML (MC)

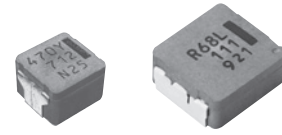

High heat resistance and high reliability
 Using metal composite core (MC)

Industrial Property : patents 21 (Registered 2/Pending 19)

Features

- High heat resistance : Operation up to 150 °C including self-heating
- High-reliability : High vibration resistance as result of newly developed integral construction; under severe reliability conditions of automotive and other strenuous applications
- High bias current : Excellent inductance stability using ferrous alloy magnetic material (Fig.1)
- Temp. stability : Excellent inductance stability over broad temp. range (Fig.1)
- Low audible (buzz) noise : New metal composite core technology
- High efficiency : Low R_{DC} of winding and low eddy-current loss of the core
- Shielded construction
- AEC-Q200 Automotive qualified
- RoHS compliant

● Fig.1 Inductance v.s. DC current, Temp.

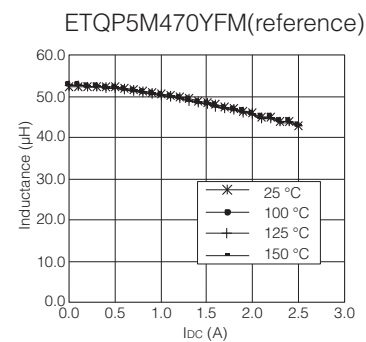

Recommended Applications

- Noise filter for various drive circuitry requiring high temp. operation and peak current handling capability
- Boost-Converter, Buck-Converter DC/DC

Standard Packing Quantity (Minimum Quantity/Packing Unit)

- 1,000 pcs./box (2 reel) : PCC-M0645M, M0754M, M0750M, M0854M, M0850M, M1054M, M1050M, M1050ML, M1060ML
- 2,000 pcs./box (2 reel) : PCC-M0530M, M0540M, M0630M

Explanation of Part Numbers

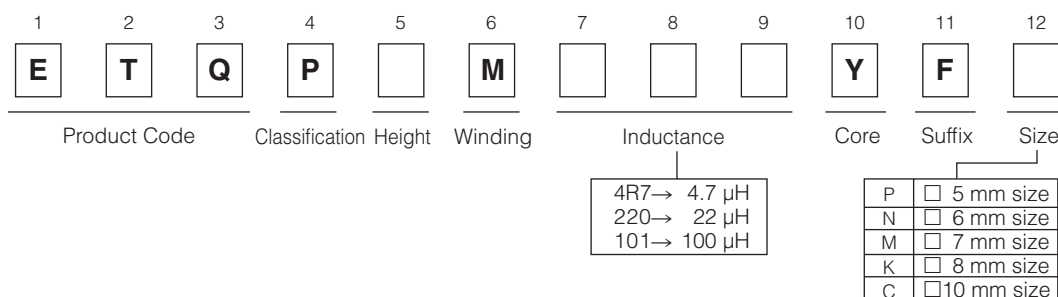

Temperature rating

Operating temperature range		T _c : -40 °C to +150 °C (Including self-temperature rise)
Storage condition	After PWB mounting	
	Before PWB mounting	T _a : -5 °C to +35 °C 85%RH max.

1. Series PCC-M0530M/PCC-M0540M (ETQP3M□□□YFP/ETQP4M□□□YFP)

Standard Parts

Series	Part No.	Inductance *1		DCR (at 20 °C) (mΩ)		Rated Current (Typ. : A)		
		L0 (μH)	Tolerance (%)	Typ. (max.)	Tolerance (%)	ΔT=40K		ΔL=-30%
						(*2)	(*3)	(*4)
PCC-M0530M [5.5×5.0×3.0(mm)]	ETQP3M2R2YFP	2.2	±20	22.6 (24.8)	±10	4.8	5.8	10.9
	ETQP3M3R3YFP	3.3		31.3 (34.4)		4.1	5.0	8.6
PCC-M0540M [5.5×5.0×4.0(mm)]	ETQP4M4R7YFP	4.7		36.0 (39.6)		4.0	4.8	7.7
	ETQP4M220YFP	22		163.0 (179.0)		1.9	2.3	3.1

(*1) Measured at 100 kHz.

(*2) DC current which causes temperature rise of 40 K. Parts are soldered by reflow on four-layer PWB (1.6 mm FR4) and measured at room temperature. See also (*5)

(*3) DC current which causes temperature rise of 40 K. Parts are soldered by reflow on multilayer PWB with high heat dissipation performance. Note: Heat radiation constant are approx. 52 K/W measured on 5.5×5.0×3.0 mm case size and approx. 48 K/W measured on 5.5×5.0×4.0 mm case size. See also (*5)

(*4) Saturation rated current : DC current which causes L(0) drop -30 %.

(*5) Within a suitable application, the part's temperature depends on circuit design and certain heat dissipation conditions. This should be double checked in a worst case operation mode.

In normal case, the max.standard operating temperature of +150 °C should not be exceeded.

For higher operating temperature conditions, please contact Panasonic representative in your area.

Performance Characteristics (Reference)

● Inductance vs DC Current

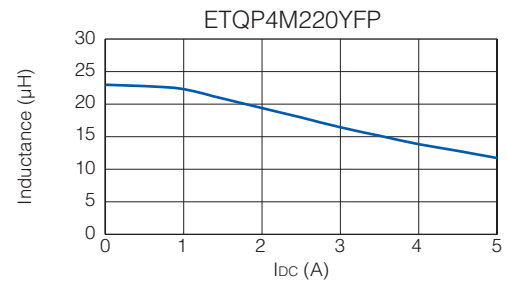
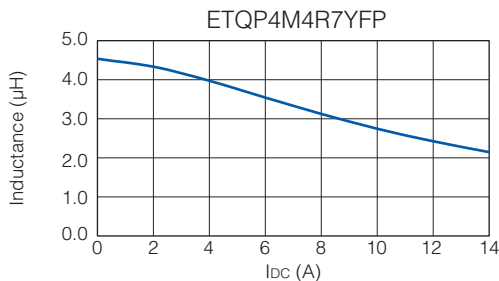
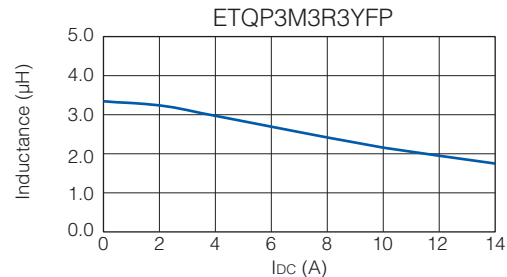
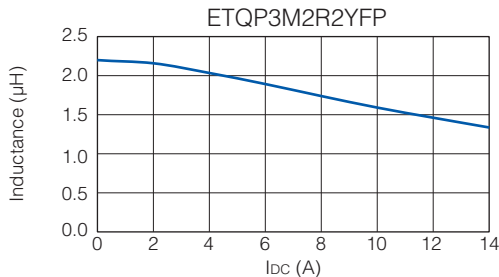

● Case Temperature vs DC Current

PWB condition A : Four-layer PWB (1.6 mm FR4), See also (*2)

PWB condition B : Multilayer PWB with high heat dissipation performance. See also (*3)

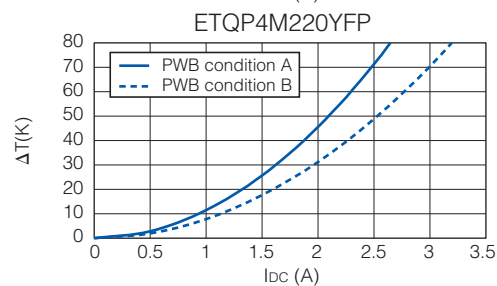
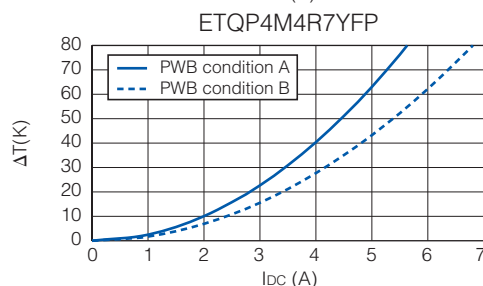
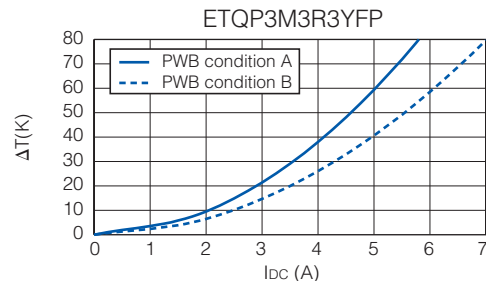
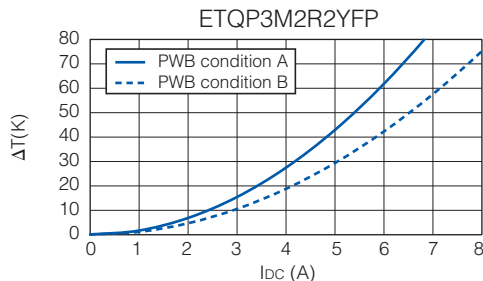

2. Series PCC-M0630M/PCC-M0645M (ETQP3M□□□YFN/ETQP4M□□□YFN)

Standard Parts								
Series	Part No.	Inductance *1		DCR (at 20 °C) (mΩ)		Rated Current (Typ. : A)		
		L0 (μH)	Tolerance (%)	Typ. (max.)	Tolerance (%)	ΔT=40K		ΔL=-30%
						(*2)	(*3)	(*4)
PCC-M0630M [6.5×6.0×3.0(mm)]	ETQP3MR68YFN	0.68	±20	6.30 (6.90)	±10	9.8	12.0	24.0
	ETQP3M1R0YFN	1.0		7.90 (8.70)		8.8	10.7	20.0
NEW PCC-M0645M [6.5×6.0×4.5(mm)]	ETQP4M3R3YFN	3.3		16.10 (17.71)		6.4	8.2	13.3
	ETQP4M6R8YFN	6.8		39.30 (43.20)		4.1	5.2	10.0
	ETQP4M100YFN	10		54.20 (59.60)		3.3	4.5	8.3
	ETQP4M220YFN	22		126.00 (138.60)		2.3	2.9	6.0
	ETQP4M330YFN	33		172.00 (189.20)		2.0	2.5	4.1
ETQP4M470YFN	47	210.00 (231.00)		1.8		2.2	3.8	

(*1) Measured at 100 kHz.

(*2) DC current which causes temperature rise of 40 K. Parts are soldered by reflow on four-layer PWB (1.6 mm FR4) and measured at room temperature. See also (*5)

(*3) DC current which causes temperature rise of 40 K. Parts are soldered by reflow on multilayer PWB with high heat dissipation performance. Note: Heat radiation constant are approx. 44 K/W measured on 6.5×6.0×3.0 mm case size and approx. 37 K/W measured on 6.5×6.0×4.5 mm case size. See also (*5)

(*4) Saturation rated current : DC current which causes L(0) drop -30 %.

(*5) Within a suitable application, the part's temperature depends on circuit design and certain heat dissipation conditions. This should be double checked in a worst case operation mode.

In normal case, the max. standard operating temperature of +150 °C should not be exceeded.

For higher operating temperature conditions, please contact Panasonic representative in your area.

Performance Characteristics (Reference)

● Inductance vs DC Current

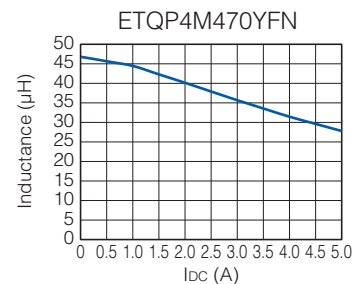
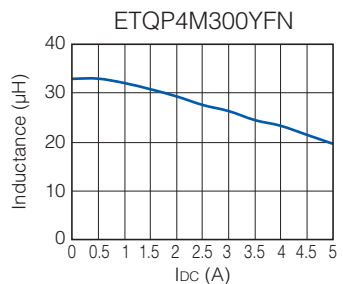
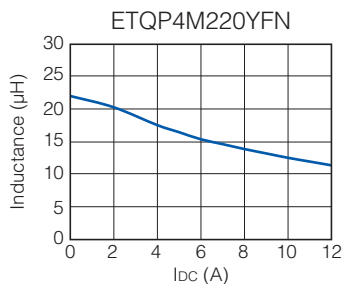
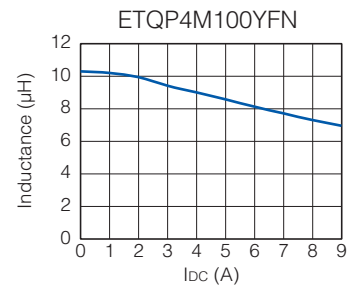
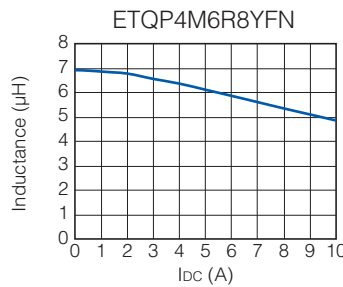
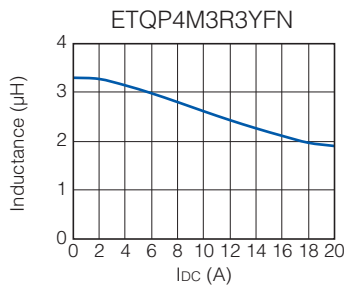
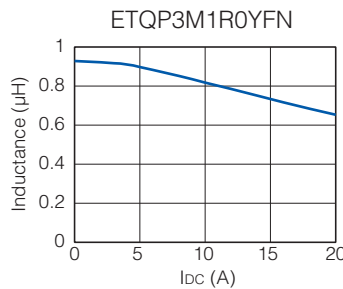
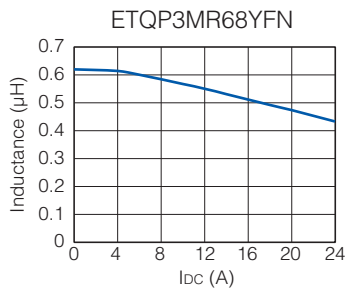

● Case Temperature vs DC Current

PWB condition A : Four-layer PWB (1.6 mm FR4), See also (*2)

PWB condition B : Multilayer PWB with high heat dissipation performance. See also (*3)

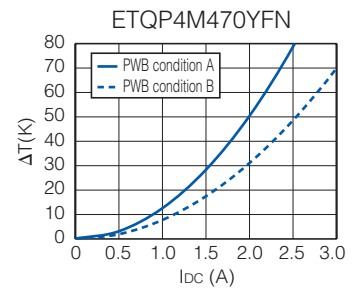
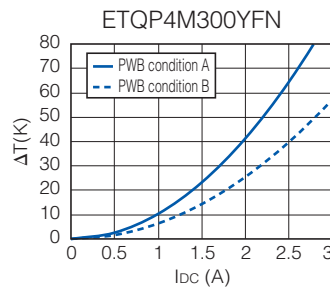
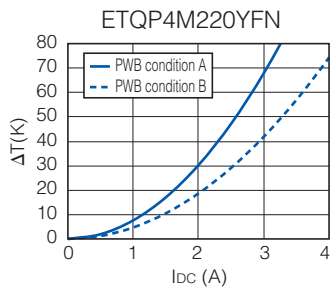
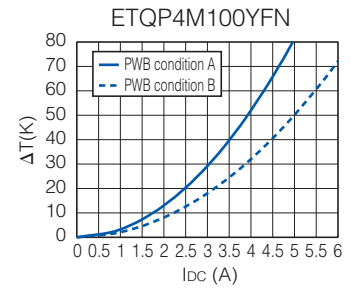
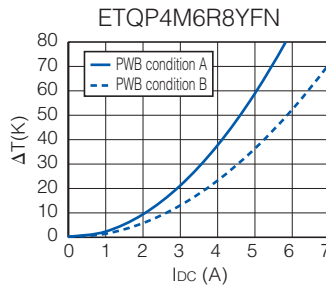
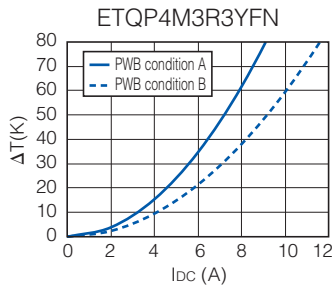
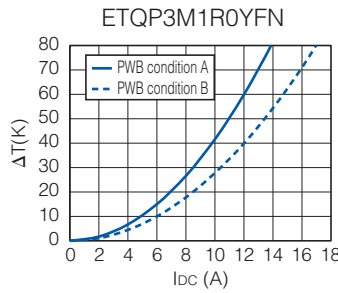
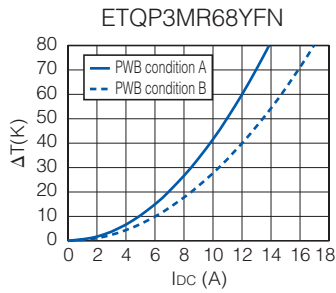

3. Series PCC-M0754M/PCC-M0750M (ETQP5M□□□YFM/ETQP5M□□□YGM)

Standard Parts

Series	Part No.	Inductance *1		DCR (at 20 °C) (mΩ)		Rated Current (Typ. : A)		
		L0 (μH)	Tolerance (%)	Typ. (max.)	Tolerance (%)	ΔT=40K		ΔL=-30%
						(*2)	(*3)	(*4)
PCC-M0754M [7.5×7.0×5.4(mm)]	ETQP5M4R7YFM	4.7	±20	20.00 (23.00)	±10	6.3	8.0	13.1
	ETQP5M6R8YFM	6.8		26.70 (29.40)		5.5	6.9	12.1
	ETQP5M100YFM	10		37.60 (41.30)		4.7	5.7	10.6
	ETQP5M220YFM	22		92.00 (102.00)		3.0	3.7	5.8
	ETQP5M330YFM	33		120.00 (132.00)		2.6	3.3	4.8
	ETQP5M470YFM	48		156.00 (172.00)		2.3	2.9	4.1
PCC-M0750M [7.5×7.0×5.0(mm)]	ETQP5M101YGM	95		348.00 (382.80)		1.4	1.9	3.1

(*1) Measured at 100 kHz.

(*2) DC current which causes temperature rise of 40 K. Parts are soldered by reflow on four-layer PWB (1.6 mm FR4) and measured at room temperature. See also (*5)

(*3) DC current which causes temperature rise of 40 K. Parts are soldered by reflow on multilayer PWB with high heat dissipation performance. Note: Heat radiation constant is approx. 31 K/W measured on 7.5×7.0×5.4 mm case size and approx. 29 K/W measured on 7.5×7.0×5.0 mm case size. See also (*5)

(*4) Saturation rated current : DC current which causes L(0) drop -30 %.

(*5) Within a suitable application, the part's temperature depends on circuit design and certain heat dissipation conditions. This should be double checked in a worst case operation mode.

In normal case, the max.standard operating temperature of +150 °C should not be exceeded.

For higher operating temperature conditions, please contact Panasonic representative in your area.

Performance Characteristics (Reference)

● Inductance vs DC Current

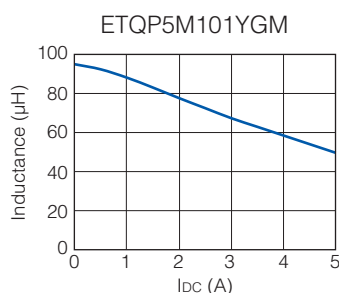
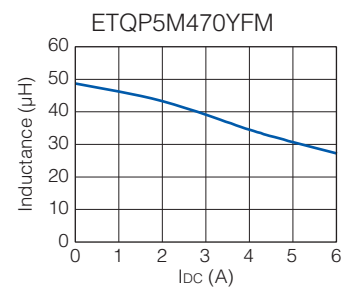
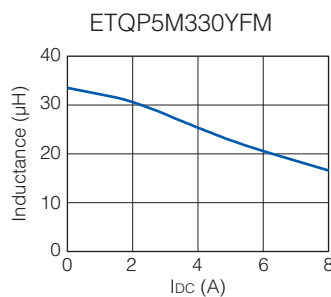
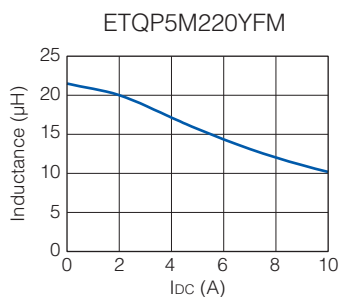
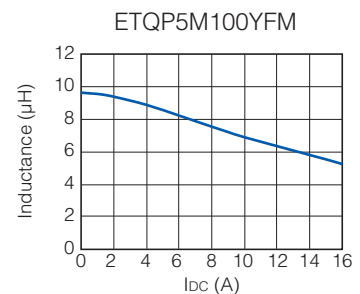
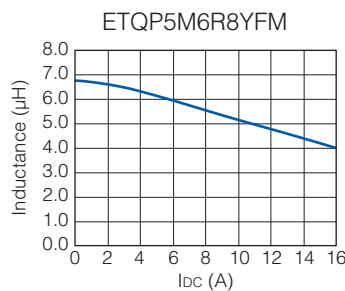
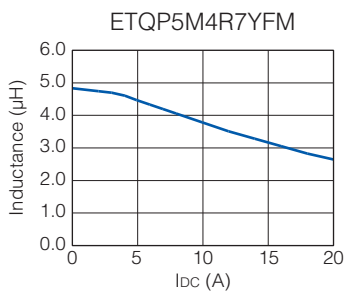

● Case Temperature vs DC Current

PWB condition A : Four-layer PWB (1.6 mm FR4), See also (*2)

PWB condition B : Multilayer PWB with high heat dissipation performance. See also (*3)

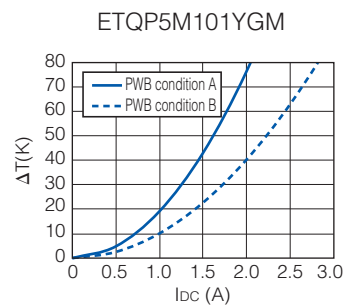
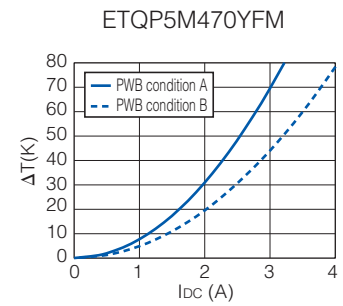
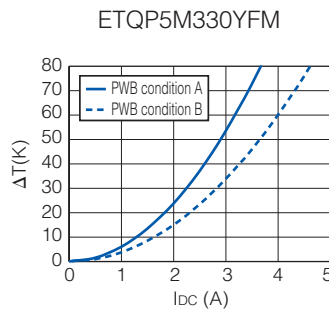
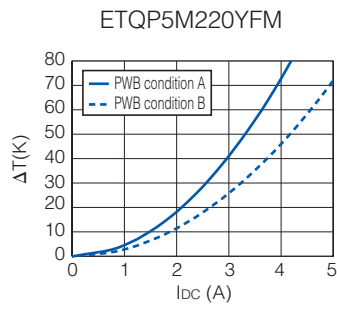
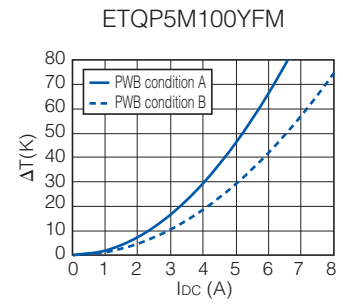
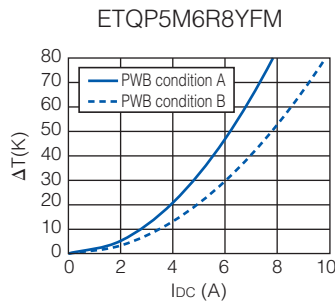
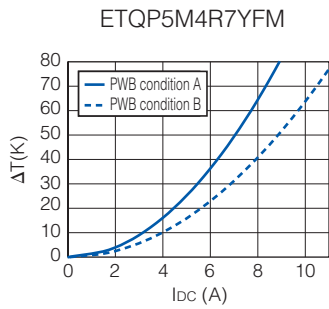

4. Series PCC-M0854M/PCC-M0850M (ETQP5M□□□YFK/ETQP5M□□□YGK)

Standard Parts		Inductance *1			DCR (at 20 °C) (mΩ)		Rated Current (Typ. : A)		
Series	Part No.	L0	Tolerance (%)	Typ. (max.)	Tolerance (%)	ΔT=40K			
		(μH)				(*)2	(*)3	(*)4	
PCC-M0854M [8.5×8.0×5.4(mm)]	ETQP5M2R5YFK	2.5	±20	7.60 (8.40)	±10	11.9	14.0	20.1	
	ETQP5M100YFK	10		33.00 (37.00)		5.7	6.7	13.0	
	ETQP5M150YFK	15		48.20 (53.10)		4.7	5.5	7.2	
	ETQP5M220YFK	22		63.00 (70.00)		4.1	4.8	6.9	
	ETQP5M470YFK	48		125.00 (138.00)		2.9	3.4	5.4	
PCC-M0850M [8.5×8.0×5.0(mm)]	ETQP5M101YGK	100		302.00 (333.00)		1.7	2.1	3.0	

(*1) Measured at 100 kHz.

(*2) DC current which causes temperature rise of 40 K. Parts are soldered by reflow on four-layer PWB (1.6 mm FR4) and measured at room temperature. See also (*5)

(*3) DC current which causes temperature rise of 40 K. Parts are soldered by reflow on multilayer PWB with high heat dissipation performance. Note: Heat radiation constant are approx. 27 K/W measured on 8.5×8.0×5.4 mm case size and approx. 29 K/W measured on 8.5×8.0×5.0 mm case size. See also (*5)

(*4) Saturation rated current : DC current which causes L(0) drop -30 %.

(*5) Within a suitable application, the part's temperature depends on circuit design and certain heat dissipation conditions. This should be double checked in a worst case operation mode.

In normal case, the max.standard operating temperature of + 150 °C should not be exceeded.

For higher operating temperature conditions, please contact Panasonic representative in your area.

Performance Characteristics (Reference)

● Inductance vs DC Current

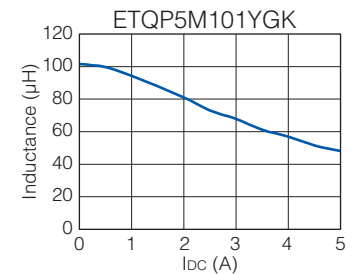
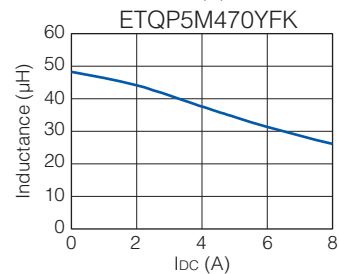
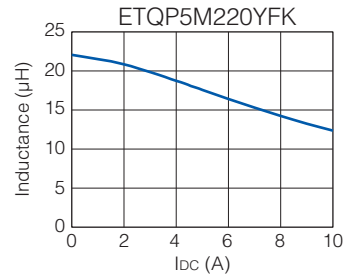
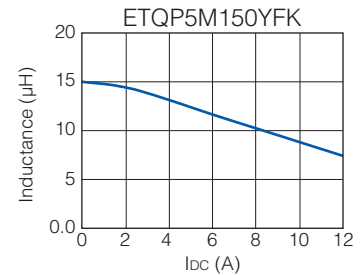
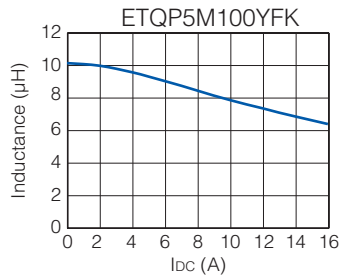
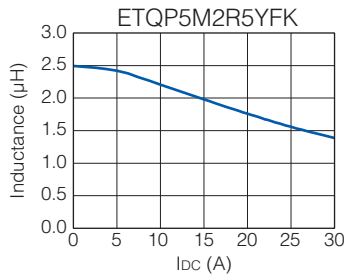

● Case Temperature vs DC Current

PWB condition A : Four-layer PWB (1.6 mm FR4), See also (*2)

PWB condition B : Multilayer PWB with high heat dissipation performance. See also (*3)

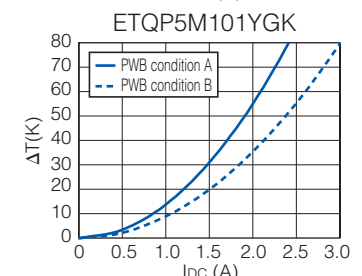
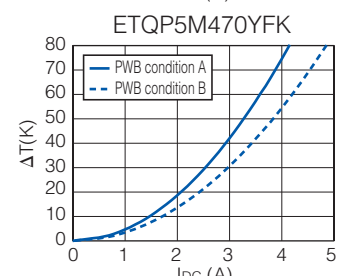
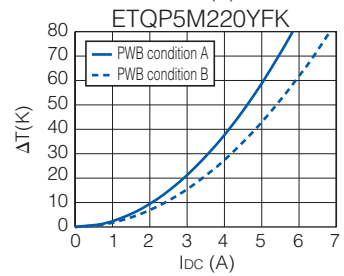
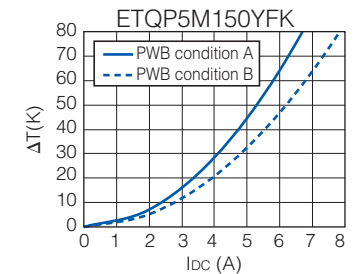
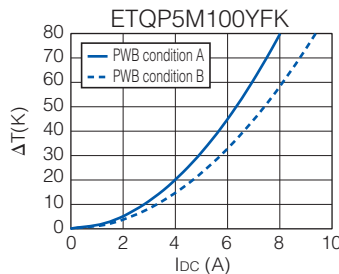
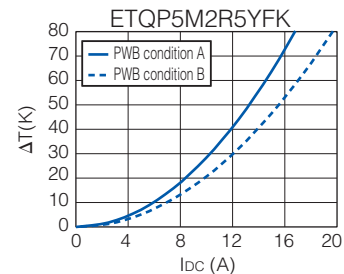

5. Series PCC-M1054M/PCC-M1050M (ETQP5M□□□YFC/ETQP5M□□□YGC)

Standard Parts

Series	Part No.	Inductance *1		DCR (at 20 °C) (mΩ)		Rated Current (Typ. : A)		
		L0 (μH)	Tolerance (%)	Typ. (max.)	Tolerance (%)	ΔT=40K (*2)	ΔT=40K (*3)	ΔL=-30% (*4)
PCC-M1054M [10.7×10.0×5.4(mm)]	ETQP5M1R5YFC	1.45	±20	3.80 (4.20)	±10	17.9	21.4	35.1
	ETQP5M2R5YFC	2.5		5.30 (5.90)		15.1	18.1	27.2
	ETQP5M3R3YFC	3.3		7.10 (7.90)		13.1	15.7	22.7
	ETQP5M4R7YFC	4.7		10.20 (11.30)		10.9	13.1	20.0
	ETQP5M100YFC	10		23.80 (26.20)		7.1	8.5	10.7
	ETQP5M150YFC	15		35.60 (39.16)		5.8	7.0	12.0
	ETQP5M220YFC	22		45.00 (50.00)		5.2	6.2	8.8
	ETQP5M330YFC	32.5		68.50 (75.40)		4.2	5.0	7.6
	ETQP5M470YFC	47		99.00 (108.90)		3.5	4.2	6.8
PCC-M1050M [10.7×10.0×5.0(mm)]	ETQP5M680YFC	66		136.00 (149.60)		3.0	3.6	4.9
	ETQP5M101YGC	97		208.00 (229.00)		2.2	2.7	3.0

(*1) Measured at 100 kHz.

(*2) DC current which causes temperature rise of 40 K. Parts are soldered by reflow on four-layer PWB (1.6 mm FR4) and measured at room temperature. See also (*5)

(*3) DC current which causes temperature rise of 40 K. Parts are soldered by reflow on multilayer PWB with high heat dissipation performance. Note: Heat radiation constant are approx. 23 K/W measured on 10.7×10.0×5.4 mm case size and approx. 26 K/W measured on 10.7×10.0×5.0 mm case size. See also (*5)

(*4) Saturation rated current : Dc current which causes L(0) drop -30 %.

(*5) Within a suitable application, the part's temperature depends on circuit design and certain heat dissipation conditions. This should be double checked in a worst case operation mode.

In normal case, the max.standard operating temperature of +150 °C should not be exceeded.

For higher operating temperature conditions, please contact Panasonic representative in your area.

Performance Characteristics (Reference)

● Inductance vs DC Current

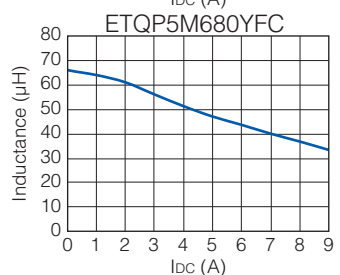
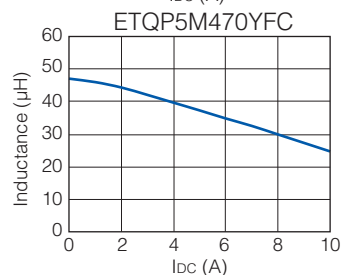
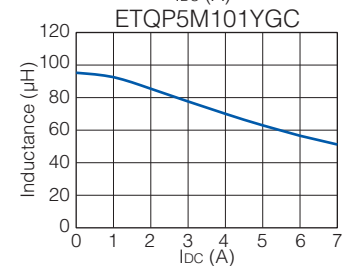
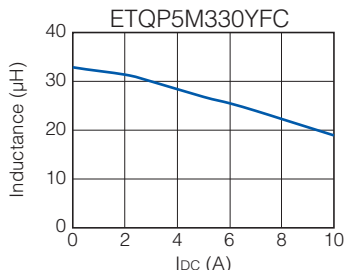
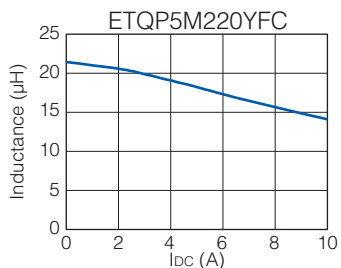
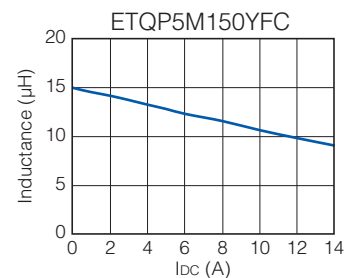
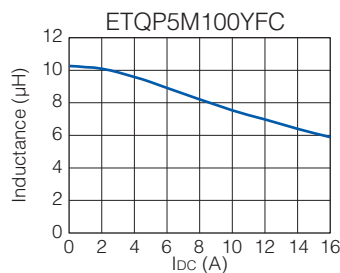
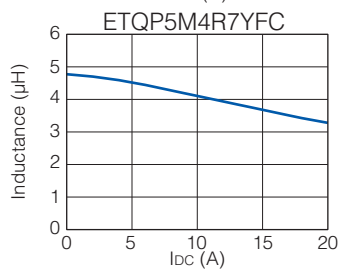
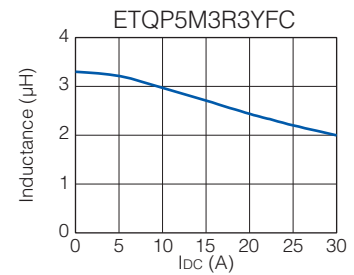
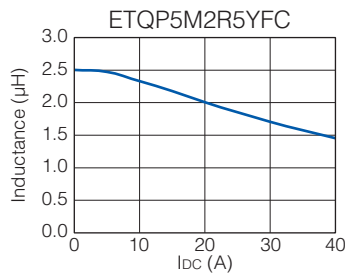
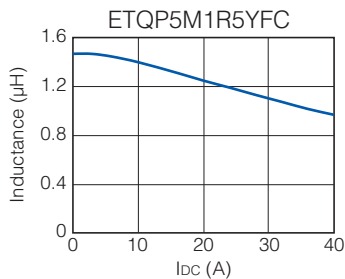

● Case Temperature vs DC Current

PWB condition A : Four-layer PWB (1.6 mm FR4), See also (*2)

PWB condition B : Multilayer PWB with high heat dissipation performance. See also (*3)

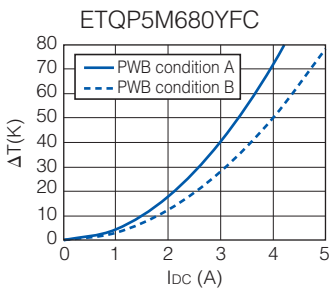
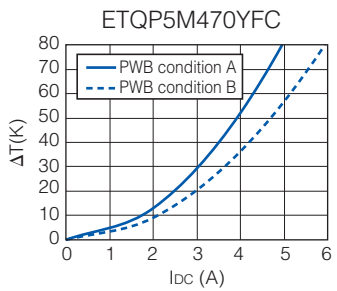
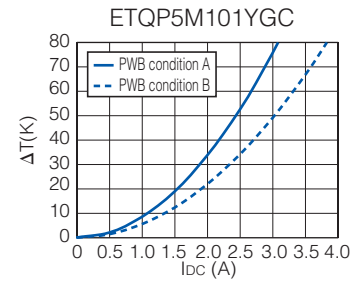
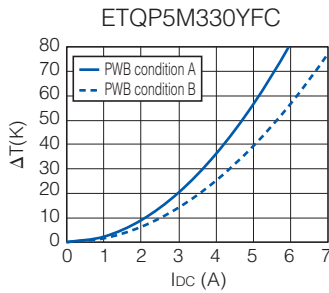
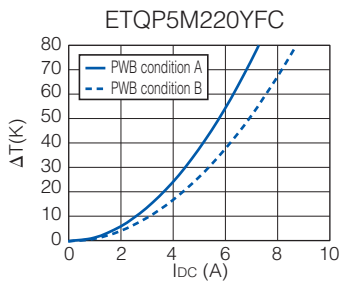
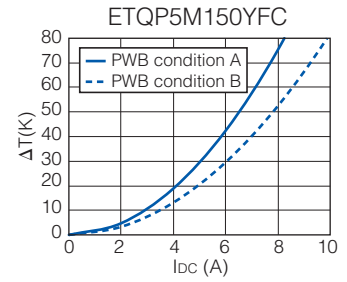
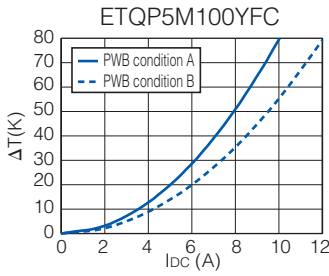
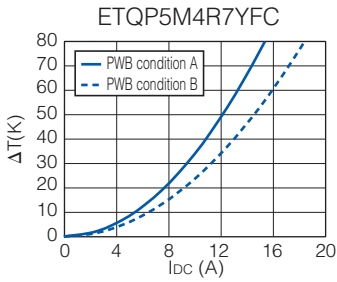
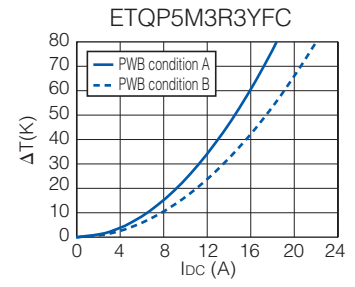
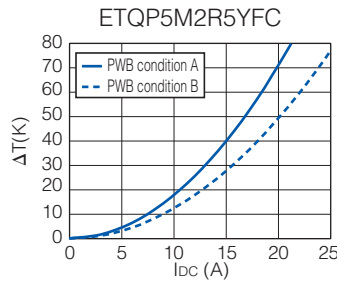
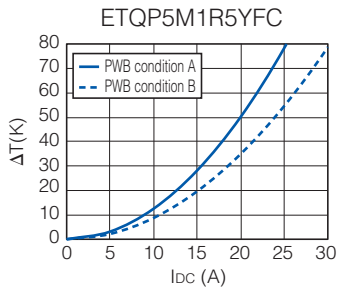

6. Series PCC-M1050ML/PCC-M1060ML (ETQP5M□□□YLC/ETQP6M□□□YLC)

Standard Parts

Series	Part No.	Inductance *1		DCR (at 20 °C) (mΩ)		Rated Current (Typ. : A)		
		L0 (μH)	Tolerance (%)	Typ. (max.)	Tolerance (%)	ΔT=40K (*2)	ΔL=-30% (*3)	ΔL=-30% (*4)
PCC-M1050ML [10.9×10.0×5.0(mm)]	ETQP5MR33YLC	0.33	±20	1.10 (1.21)	±10	33.2	39.7	56.7
	ETQP5MR68YLC	0.68		1.75 (1.93)		26.3	31.5	40.0
	ETQP5M1R0YLC	1.0		2.30 (2.53)		23.0	27.5	37.8
	ETQP5M2R0YLC	2.0		4.60 (5.06)		16.2	19.4	31.3
PCC-M1060ML [10.9×10.0×6.0(mm)]	ETQP6M1R5YLC	1.5	±20	3.20 (3.52)	±10	19.5	23.3	32.0
	ETQP6M2R5YLC	2.5		4.55 (5.00)		16.3	19.6	25.8
	ETQP6M3R3YLC	3.3		6.00 (6.60)		14.2	17.0	26.3
	ETQP6M4R7YLC	4.7		8.70 (9.57)		11.8	14.1	22.5

(*1) Measured at 100 kHz.

(*2) DC current which causes temperature rise of 40 K. Parts are soldered by reflow on four-layer PWB (1.6 mm FR4) and measured at room temperature. See also (*5)

(*3) DC current which causes temperature rise of 40 K. Parts are soldered by reflow on multilayer PWB with high heat dissipation performance. Note: Heat radiation constant are approx. 23 K/W measured on 10.9×10.0×5.0 mm case size and approx. 23 K/W measured on 10.9×10.0×6.0 mm case size. See also (*5)

(*4) Saturation rated current : Dc current which causes L(0) drop -30 %.

(*5) Within a suitable application, the part's temperature depends on circuit design and certain heat dissipation conditions. This should be double checked in a worst case operation mode.

In normal case, the max.standard operating temperature of +150 °C should not be exceeded.

For higher operating temperature conditions, please contact Panasonic representative in your area.

Performance Characteristics (Reference)

● Inductance vs DC Current

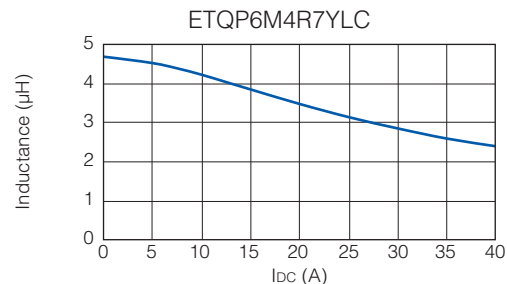
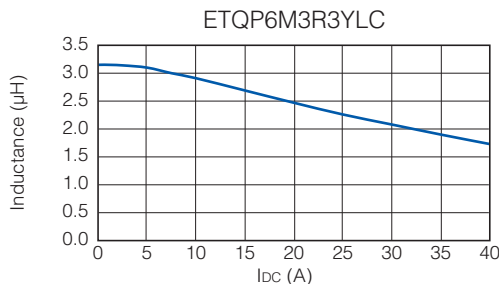
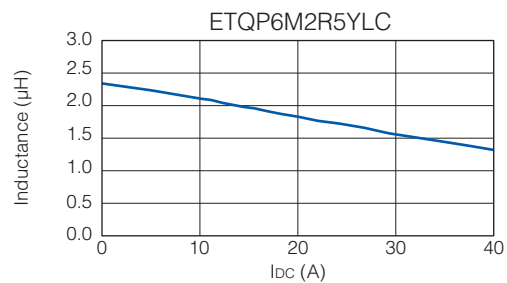
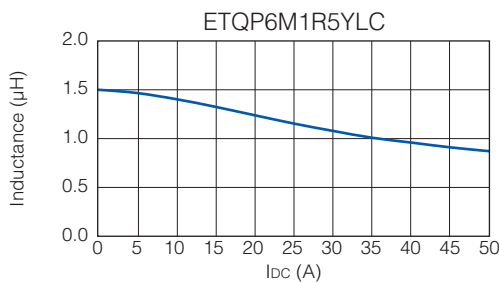
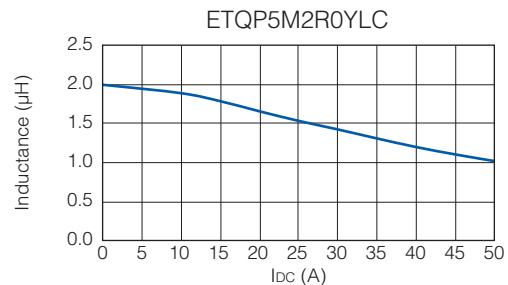
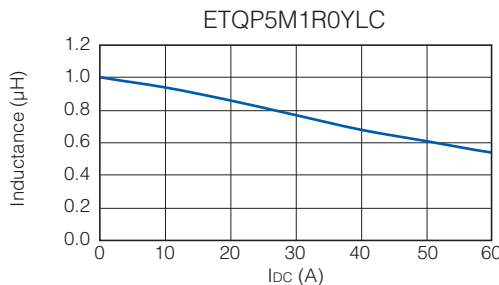
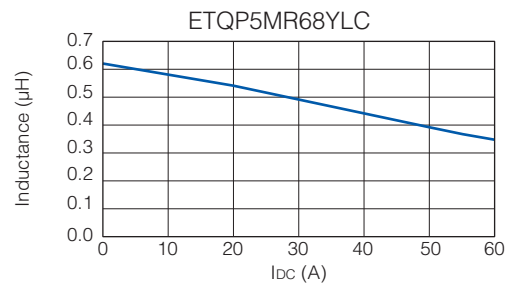
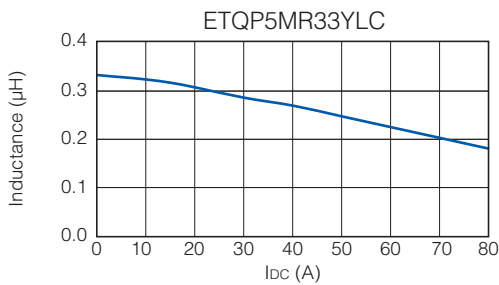

● Case Temperature vs DC Current

PWB condition A : Four-layer PWB (1.6 mm FR4), See also (*2)

PWB condition B : Multilayer PWB with high heat dissipation performance. See also (*3)

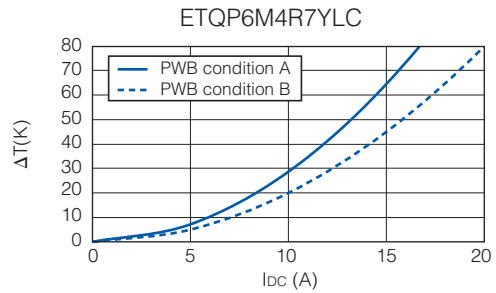
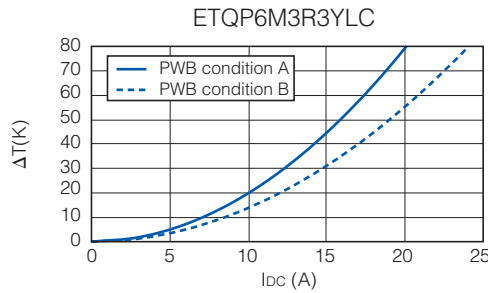
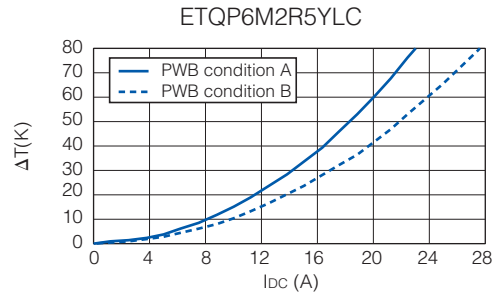
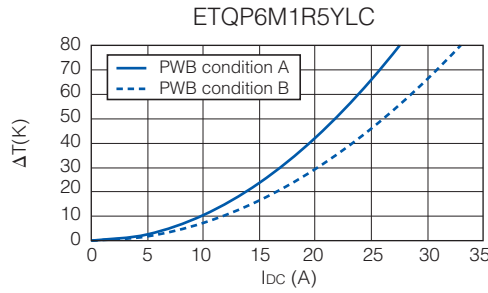
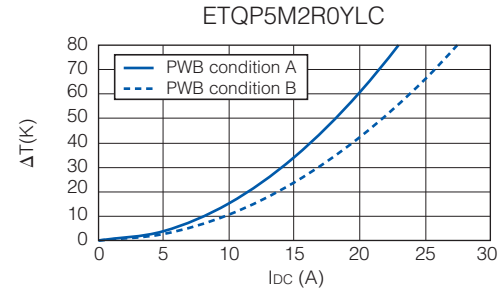
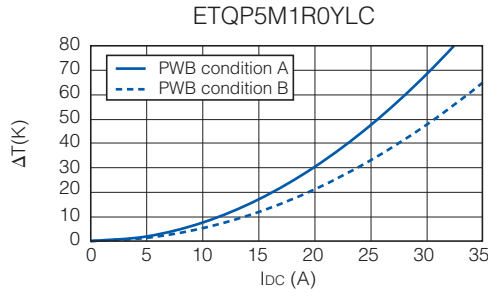
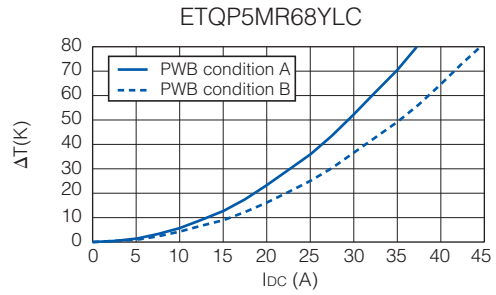
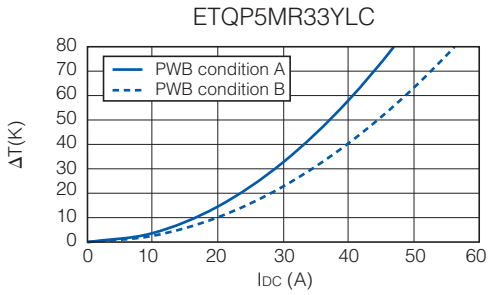

Dimensions in mm (not to scale)

Dimensional tolerance unless noted : ± 0.5

Series PCC-M0530M
Series PCC-M0540M
(ETQP3M□□□YFP/ETQP4M□□□YFP)

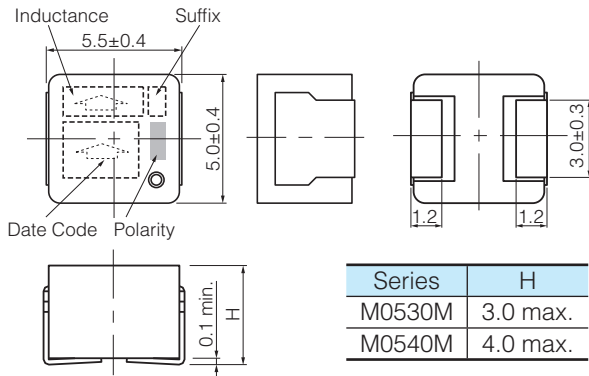

Series PCC-M0630M
Series PCC-M0645M
(ETQP3M□□□YFN/ETQP4M□□□YFN)

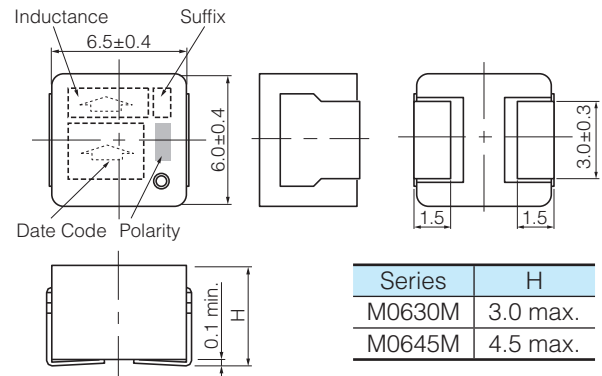

Series PCC-M0754M
Series PCC-M0750M
(ETQP5M□□□YFM/YGM)

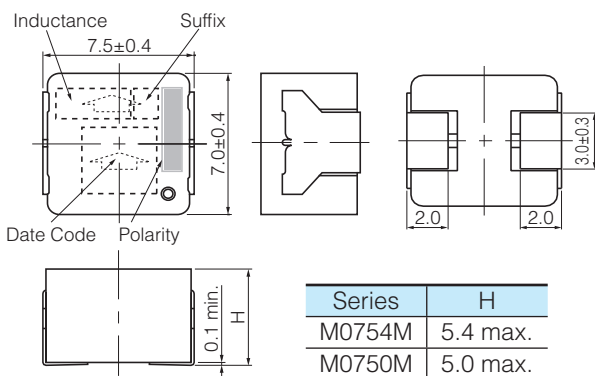

Series PCC-M0854M
Series PCC-M0850M
(ETQP5M□□□YFK/YGK)

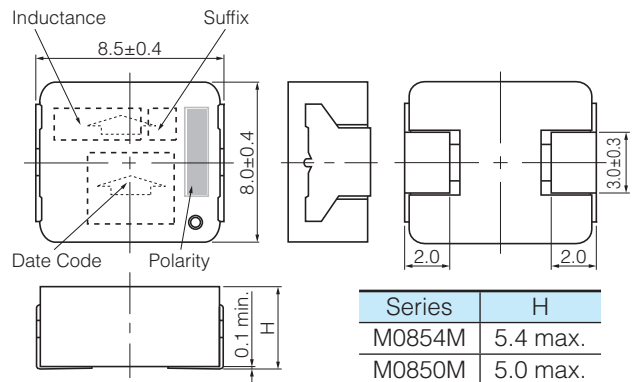

Series PCC-M1054M
Series PCC-M1050M
(ETQP5M□□□YFC/YGC)

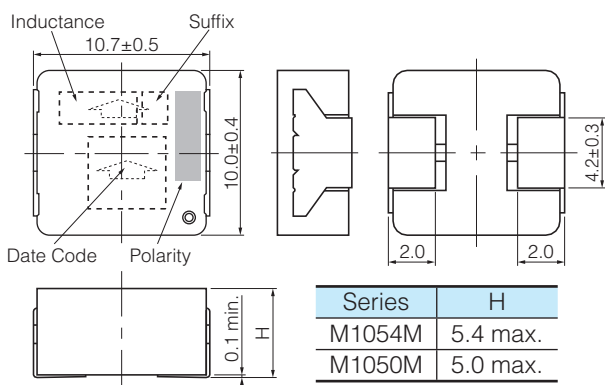

Series PCC-M1050ML
Series PCC-M1060ML
(ETQP5M□□□YLC/ETQP6M□□□YLC)

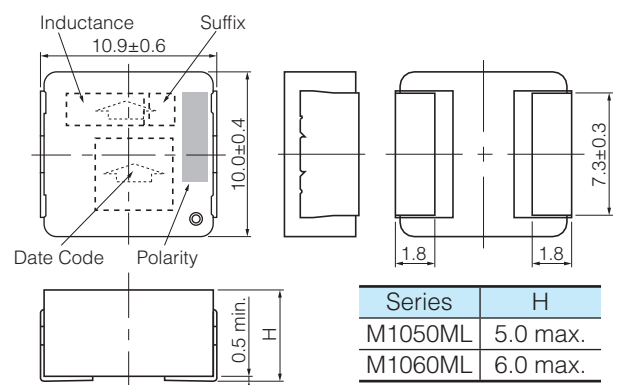

Recommended Land Pattern in mm (not to scale)

Dimensional tolerance unless noted : ± 0.5

Series PCC-M0530M
Series PCC-M0540M
(ETQP3M□□□YFP/ETQP4M□□□YFP)

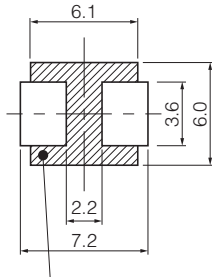

Don't wire on the pattern on shaded portion the PWB.

Series PCC-M0630M
Series PCC-M0645M
(ETQP3M□□□YFN/ETQP4M□□□YFN)

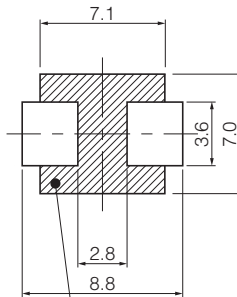

The same as the left.

Series PCC-M0754M
Series PCC-M0750M
(ETQP5M□□□YFM/YGM)

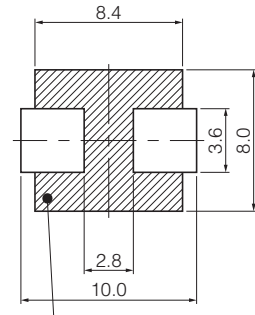

The same as the left.

Series PCC-M0854M
Series PCC-M0850M
(ETQP5M□□□YFK/YGK)

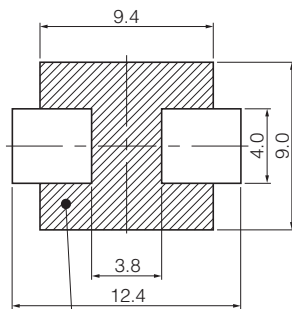

Don't wire on the pattern on shaded portion the PWB.

Series PCC-M1054M
Series PCC-M1050M
(ETQP5M□□□YFC/YGC)

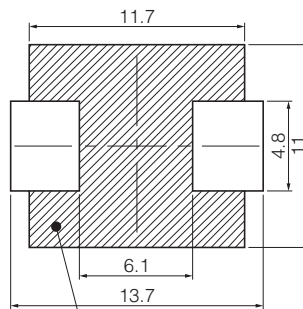

The same as the left.

Series PCC-M1050ML
Series PCC-M1060ML
(ETQP5M□□□YLC/ETQP6M□□□YLC)

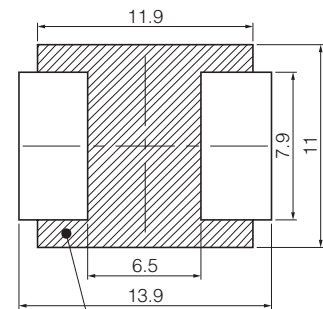

The same as the left.

■ As for Soldering Conditions and Safety Precautions (Power Choke Coils (Automotive Grade)),

Please see Data Files

Packaging Methods (Taping)

- Embossed Carrier Tape Dimensions in mm (not to scale)

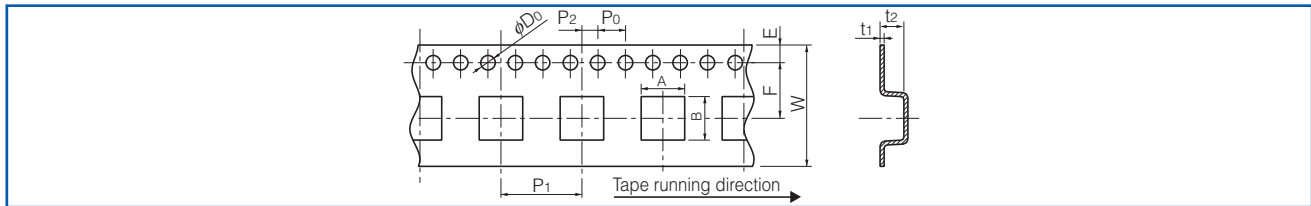

Series	A	B	W	E	F	P ₁	P ₂	P ₀	φD ₀	t ₁	t ₂
PCC-M0530M	5.6	6.1	16.0	1.75	7.5	12.0	2.0	4.0	1.5	0.4	3.3
PCC-M0540M											4.3
PCC-M0630M	7.1	6.6									3.3
PCC-M0645M											5.0
PCC-M0754M/M0750M	8.1	7.6									6.0
PCC-M0854M/M0850M	9.1	8.6									6.0
PCC-M1054M/M1050M PCC-M1050ML/M1060ML	10.7	11.9	24.0	11.5	16.0	0.5	6.3				

- Taping Reel Dimensions in mm (not to scale)

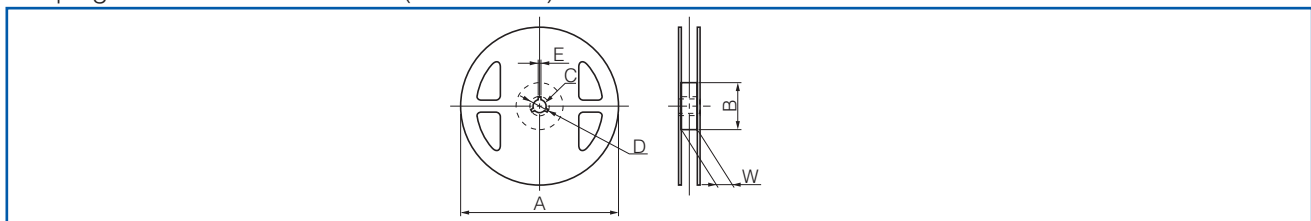

Standard Reel Dimensions

Series	A	B	C	D	E	W
PCC-M0530M/M0540M PCC-M0630M/M0645M PCC-M0754M/M0750M PCC-M0854M/M0850M	330	100	13	21	2	17.5
PCC-M1054M/M1050M PCC-M1050ML/M1060ML						25.5

Component Placement (Taping)

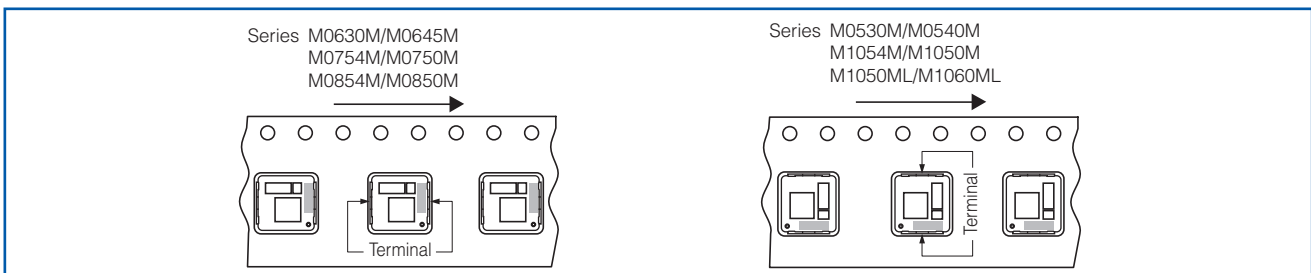

Standard Packing Quantity/Reel

Series	Part No.	Minimum Quantity / Packing Unit	Quantity per reel
PCC-M0530M	ETQP3M□□□YFP	2,000 pcs. / box (2 reel)	1,000 pcs.
PCC-M0540M	ETQP4M□□□YFP		
PCC-M0630M	ETQP3M□□□YFN		
PCC-M0645M	ETQP4M□□□YFN	1,000 pcs. / box (2 reel)	500 pcs.
PCC-M0754M	ETQP5M□□□YFM		
PCC-M0750M	ETQP5M□□□YGM		
PCC-M0854M	ETQP5M□□□YFK		
PCC-M0850M	ETQP5M□□□YGK		
PCC-M1054M	ETQP5M□□□YFC		
PCC-M1050M	ETQP5M□□□YGC		
PCC-M1050ML	ETQP5M□□□YLC		
PCC-M1060ML	ETQP6M□□□YLC		