



Inductors CONTENTS

Classification	Product Item	Type · Series	Part Number	Page	
Power Inductors (SMD)	Power Choke Coils	PCC- M0530M/M0540M M0630M/M0645M M0754M/M0750M/M0854M M0850M/M1054M/M1050M M1050ML/M1060ML (MC) (Automotive Grade)	ETQ P3M□□□Y□□ ETQ P4M□□□Y□□ ETQ P5M□□□Y□□ ETQ P6M□□□Y□□	2	
		PCC- M1050MS(MC) (Automotive Grade)	ETQ P5M□□□YSC	16	
		PCC- M1280MF (MC) (Automotive Grade)	ETQ P8M□□□JFA	19	
		PCC- M0530M-LP/M0630M-LP M0840M-LP/M1040M-LP (MC) (Automotive Grade)	ETQ P3M□□□KV□ ETQ P4M□□□KV□	24	
		PCC- M0648M-LE M0748M-LE (MC) (Automotive Grade)	ETQ P4M□□□KFN ETQ P4M□□□KFM	36	
		PCC- M0530M-H/M0630M-H (MC) (Automotive Grade)	ETQ P3M□□□HF□	41	
		PCC-D1413H (DUST) (Automotive Grade)	ETQ PDH240DTV	45	
		Soldering Conditions (PCC for automotive use)			48
		Safety Precautions (PCC for automotive use)			49
		PCC-M0730L (MC) for consumer use		ETQ P3L	51
		PCC-M0740L (MC) Low DCR Type for consumer use		ETQ P4L	53
		PCC-M1040L (MC) for consumer use		ETQ P4L	55
		PCC-M1040L (MC) Low DCR Type for consumer use		ETQ P4L	57
		PCC-M1250L (MC) for consumer use		ETQ P5L	59
		Packaging Methods · Soldering Conditions (PCC for consumer use)			61
		Safety Precautions (PCC for consumer use)			63
			Voltage Step-up Coils	Chip	ELT 3KN

All products in this catalog comply with the RoHS Directive.

The RoHS Directive is “the Directive (2011/65/EU) on the Restriction of the Use of Certain Hazardous Substances in Electrical and Electronic Equipment “ and its revisions.

Power Choke Coil (Automotive Grade)

Series: **PCC-M0530M (MC) PCC-M0540M (MC)**
PCC-M0630M (MC) PCC-M0645M (MC)
PCC-M0754M (MC) PCC-M0750M (MC)
PCC-M0854M (MC) PCC-M0850M (MC)
PCC-M1054M (MC) PCC-M1050M (MC)
PCC-M1050ML (MC) PCC-M1060ML (MC)

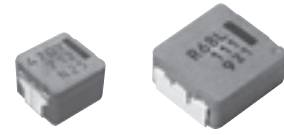

High heat resistance and high reliability
 Using metal composite core (MC)

Industrial Property : patents 21 (Registered 2/Pending 19)

Features

- High heat resistance : Operation up to 150 °C including self-heating
- High-reliability : High vibration resistance as result of newly developed integral construction; under severe reliability conditions of automotive and other strenuous applications
- High bias current : Excellent inductance stability using ferrous alloy magnetic material (Fig.1)
- Temp. stability : Excellent inductance stability over broad temp. range (Fig.1)
- Low audible (buzz) noise : New metal composite core technology
- High efficiency : Low R_{DC} of winding and low eddy-current loss of the core
- Shielded construction
- AEC-Q200 Automotive qualified
- RoHS compliant

● Fig.1 Inductance v.s. DC current, Temp.

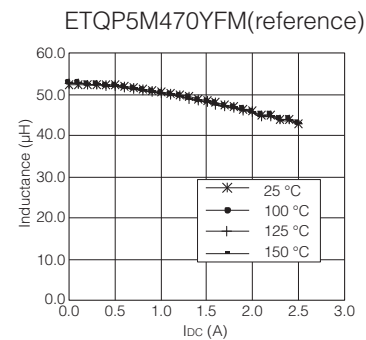

Recommended Applications

- Noise filter for various drive circuitry requiring high temp. operation and peak current handling capability
- Boost-Converter, Buck-Converter DC/DC

Standard Packing Quantity (Minimum Quantity/Packing Unit)

- 1,000 pcs/box (2 reel) : PCC-M0645M, M0754M, M0750M, M0854M, M0850M, M1054M, M1050M, M1050ML, M1060ML
- 2,000 pcs/box (2 reel) : PCC-M0530M, M0540M, M0630M

Explanation of Part Numbers

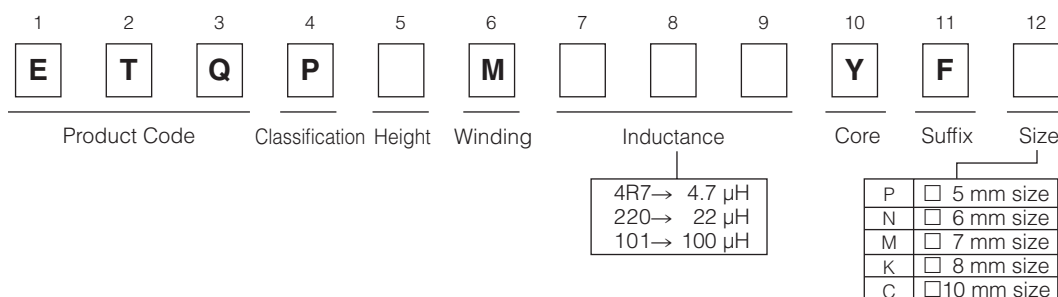

Temperature rating

Operating temperature range		Tc : -40 °C to +150 °C (Including self-temperature rise)
Storage condition	After PWB mounting	
	Before PWB mounting	Ta : -5 °C to +35 °C 85%RH max.

Design and specifications are each subject to change without notice. Ask factory for the current technical specifications before purchase and/or use.
 Should a safety concern arise regarding this product, please be sure to contact us immediately.

1. Series PCC-M0530M/PCC-M0540M (ETQP3M□□□YFP/ETQP4M□□□YFP)

Standard Parts

Part No.	Inductance *1		DCR (at 20 °C) (mΩ)		Rated Current (Typ. : A)			Series
	L0 (μH)	Tolerance (%)	Typ. (max.)	Tolerance (%)	ΔT=40K		ΔL=-30%	
					(*2)	(*3)		
ETQP3M2R2YFP	2.2	±20	22.6 (24.8)	±10	4.8	5.8	10.9	PCC-M0530M [5.5×5.0×3.0(mm)]
ETQP3M3R3YFP	3.3		31.3 (34.4)		4.1	5.0	8.6	
ETQP4M4R7YFP	4.6		36.0 (39.6)		4.0	4.8	7.7	PCC-M0540M [5.5×5.0×4.0(mm)]
ETQP4M220YFP	22		163.0 (179.0)		1.9	2.3	3.1	

(*1) Measured at 100 kHz.

(*2) DC current which causes temperature rise of 40 K. Parts are soldered by reflow on four-layer PWB (1.6 mm FR4) and measured at room temperature. See also (*5)

(*3) DC current which causes temperature rise of 40 K. Parts are soldered by reflow on multilayer PWB with high heat dissipation performance. Note: Heat radiation constant are approx. 52 K/W measured on 5.5×5.0×3.0 mm case size and approx. 48 K/W measured on 5.5×5.0×4.0 mm case size. See also (*5)

(*4) Saturation rated current : DC current which causes L(0) drop -30 %.

(*5) Within a suitable application, the part's temperature depends on circuit design and certain heat dissipation conditions. This should be double checked in a worst case operation mode.

In normal case, the max.standard operating temperature of +150 °C should not be exceeded.

For higher operating temperature conditions, please contact Panasonic representative in your area.

Performance Characteristics (Reference)

● Inductance vs DC Current

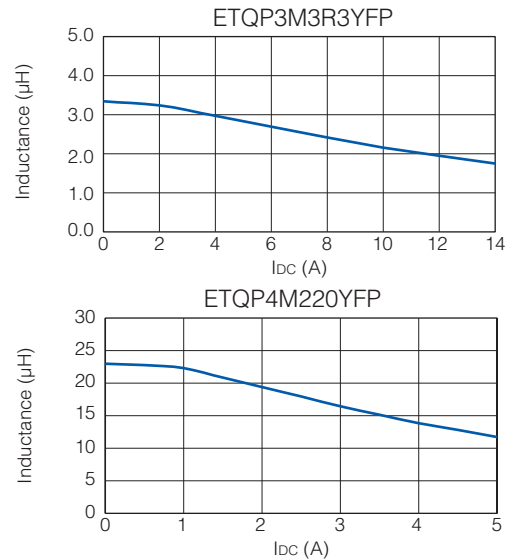
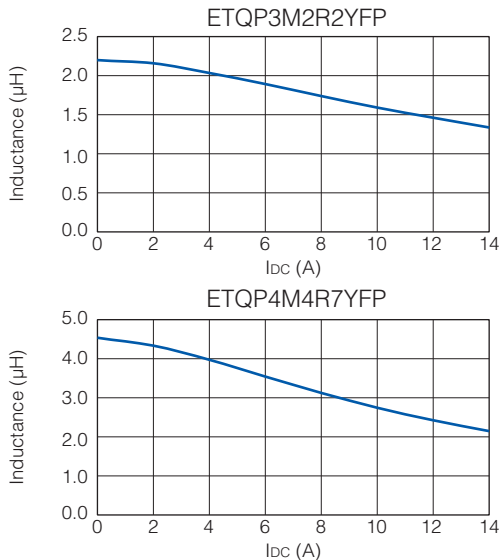

● Case Temperature vs DC Current

PWB condition A : Four-layer PWB (1.6 mm FR4), See also (*2)

PWB condition B : Multilayer PWB with high heat dissipation performance. See also (*3)

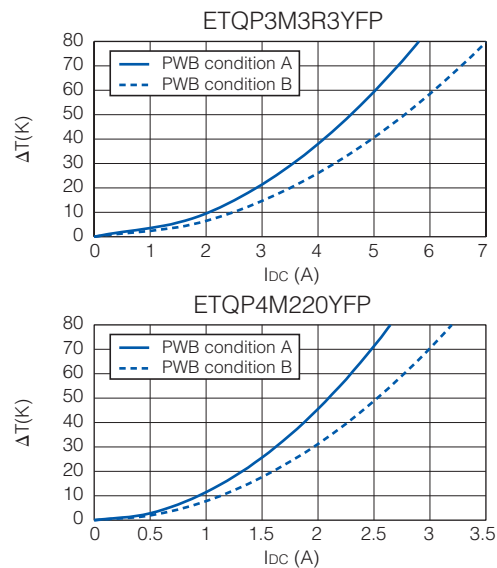
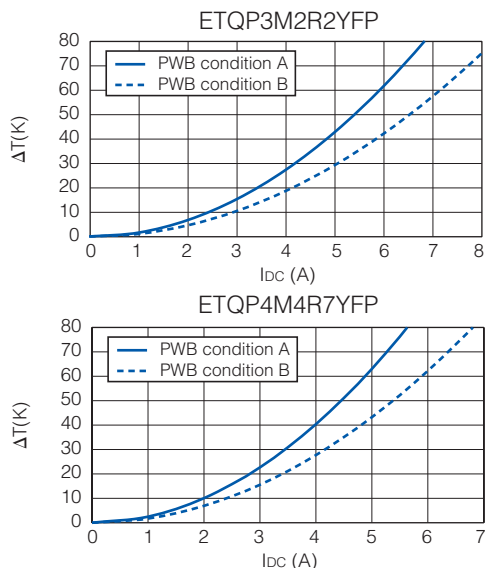

2. Series PCC-M0630M/PCC-M0645M (ETQP3M□□□YFN/ETQP4M□□□YFN)

Standard Parts

Part No.	Inductance *1		DCR (at 20 °C) (mΩ)		Rated Current (Typ. : A)			Series
	L0 (μH)	Tolerance (%)	Typ. (max.)	Tolerance (%)	ΔT=40K		ΔL=-30% (*4)	
					(*2)	(*3)		
ETQP3MR68YFN	0.68	±20	6.30 (6.90)	±10	9.8	12.0	24.0	PCC-M0630M [6.5×6.0×3.0(mm)]
ETQP3M1R0YFN	1.0		7.90 (8.70)		8.8	10.7	20.0	
ETQP4M3R3YFN	3.3		16.10 (17.71)		6.4	8.2	13.3	
ETQP4M6R8YFN	6.8		39.30 (43.20)		4.1	5.2	10.0	PCC-M0645M [6.5×6.0×4.5(mm)]
ETQP4M100YFN	10		54.20 (59.60)		3.5	4.5	8.3	
ETQP4M220YFN	22		126.00 (138.60)		2.3	2.9	6.0	
ETQP4M330YFN	33		172.00 (189.20)		2.0	2.5	4.1	
ETQP4M470YFN	47		210.00 (231.00)		1.8	2.2	3.8	

(*1) Measured at 100 kHz.

(*2) DC current which causes temperature rise of 40 K. Parts are soldered by reflow on four-layer PWB (1.6 mm FR4) and measured at room temperature. See also (*5)

(*3) DC current which causes temperature rise of 40 K. Parts are soldered by reflow on multilayer PWB with high heat dissipation performance. Note: Heat radiation constant are approx. 44 K/W measured on 6.5×6.0×3.0 mm case size and approx. 37 K/W measured on 6.5×6.0×4.5 mm case size. See also (*5)

(*4) Saturation rated current : DC current which causes L(0) drop -30 %.

(*5) Within a suitable application, the part's temperature depends on circuit design and certain heat dissipation conditions. This should be double checked in a worst case operation mode.

In normal case, the max. standard operating temperature of +150 °C should not be exceeded.

For higher operating temperature conditions, please contact Panasonic representative in your area.

Performance Characteristics (Reference)

● Inductance vs DC Current

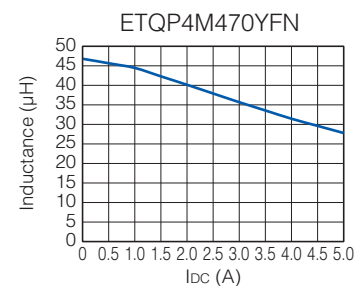
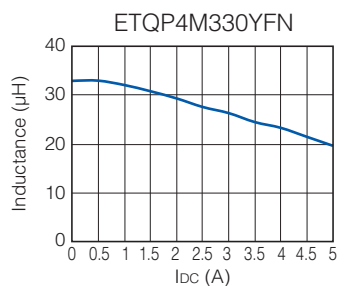
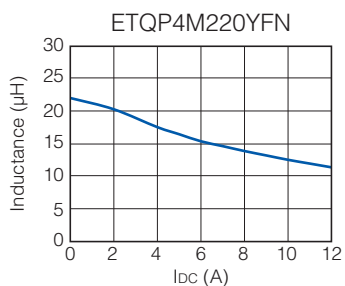
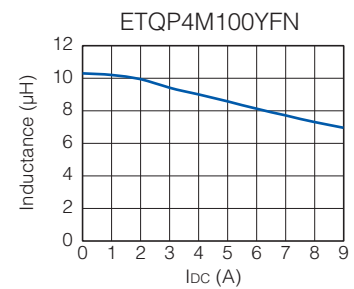
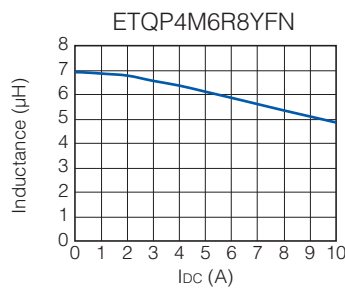
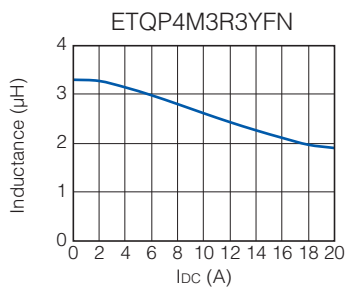
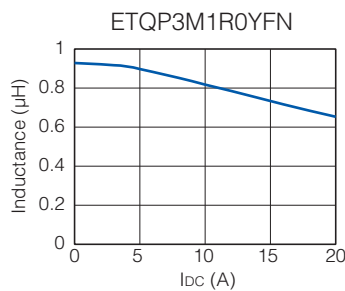
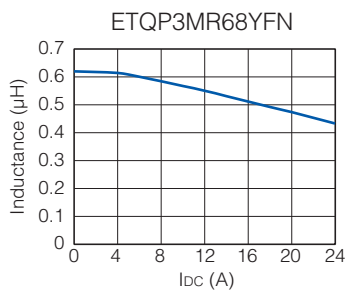

● Case Temperature vs DC Current

PWB condition A : Four-layer PWB (1.6 mm FR4), See also (*2)

PWB condition B : Multilayer PWB with high heat dissipation performance. See also (*3)

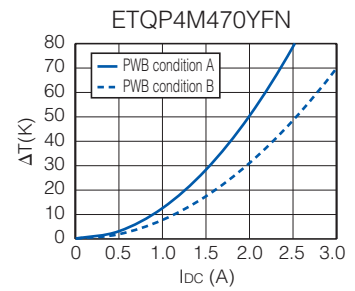
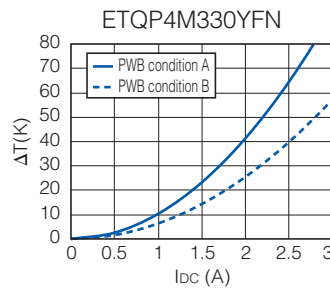
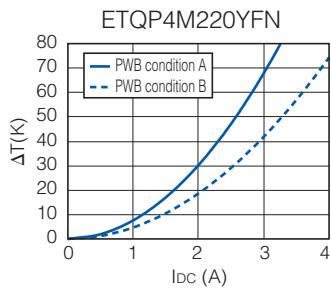
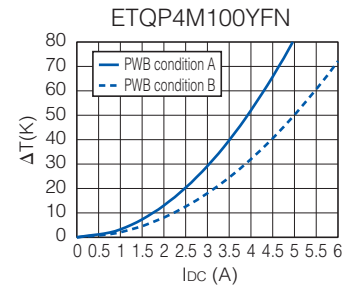
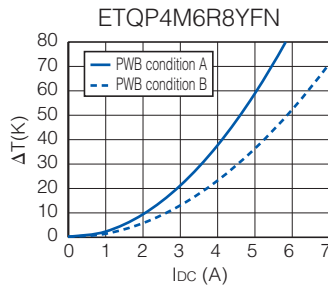
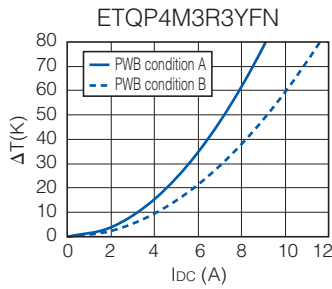
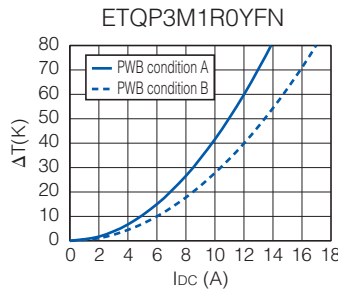
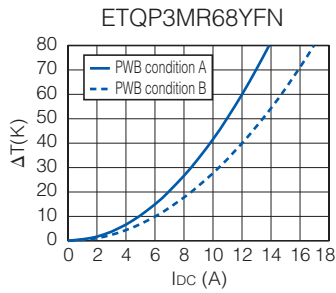

3. Series PCC-M0754M/PCC-M0750M (ETQP5M□□□YFM/ETQP5M□□□YGM)

Standard Parts

Part No.	Inductance *1		DCR (at 20 °C) (mΩ)		Rated Current (Typ. : A)			Series
	L0 (μH)	Tolerance (%)	Typ. (max.)	Tolerance (%)	ΔT=40K		ΔL=-30% (*4)	
					(*2)	(*3)		
ETQP5M4R7YFM	4.7	±20	20.40 (22.50)	±10	6.3	8.0	13.1	PCC-M0754M [7.5×7.0×5.4(mm)]
ETQP5M6R8YFM	6.8		26.70 (29.40)		5.5	6.9	12.1	
ETQP5M100YFM	10		37.60 (41.30)		4.7	5.7	10.6	
ETQP5M220YFM	22		92.00 (102.00)		3.0	3.7	5.8	
ETQP5M330YFM	33		120.00 (132.00)		2.6	3.3	4.8	
ETQP5M470YFM	48		156.00 (172.00)		2.3	2.9	4.1	
ETQP5M101YGM	95		348.00 (382.80)		1.4	1.9	3.1	PCC-M0750M [7.5×7.0×5.0(mm)]

(*1) Measured at 100 kHz.

(*2) DC current which causes temperature rise of 40 K. Parts are soldered by reflow on four-layer PWB (1.6 mm FR4) and measured at room temperature. See also (*5)

(*3) DC current which causes temperature rise of 40 K. Parts are soldered by reflow on multilayer PWB with high heat dissipation performance. Note: Heat radiation constant is approx. 31 K/W measured on 7.5×7.0×5.4 mm case size and approx. 29 K/W measured on 7.5×7.0×5.0 mm case size. See also (*5)

(*4) Saturation rated current : DC current which causes L(0) drop -30 %.

(*5) Within a suitable application, the part's temperature depends on circuit design and certain heat dissipation conditions. This should be double checked in a worst case operation mode.

In normal case, the max.standard operating temperature of +150 °C should not be exceeded.

For higher operating temperature conditions, please contact Panasonic representative in your area.

Performance Characteristics (Reference)

● Inductance vs DC Current

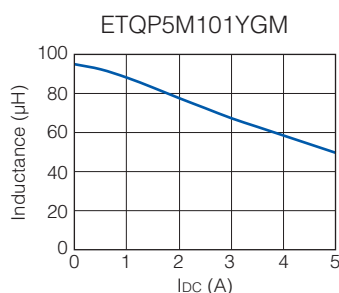
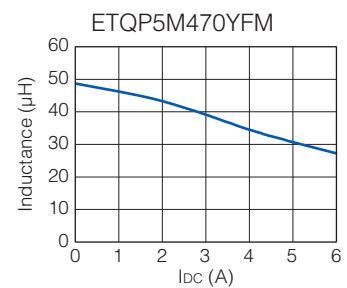
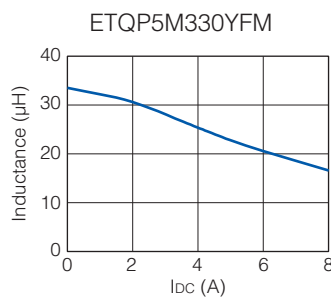
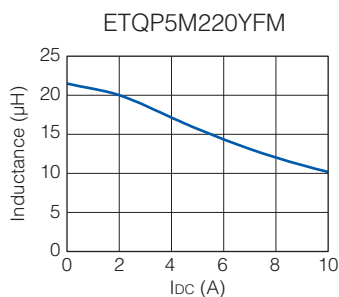
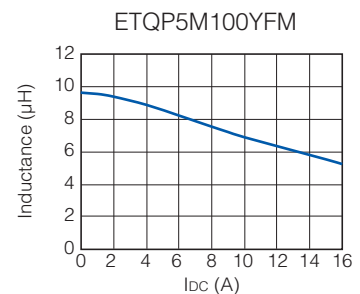
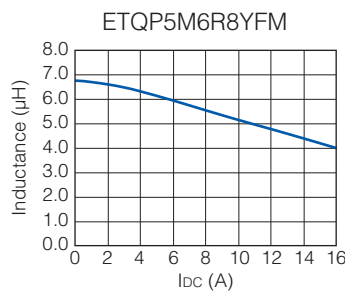
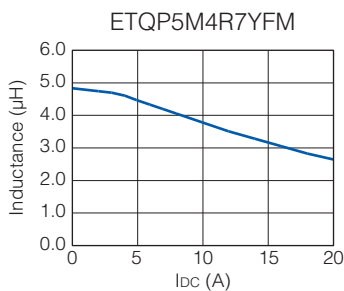

● Case Temperature vs DC Current

PWB condition A : Four-layer PWB (1.6 mm FR4), See also (*2)

PWB condition B : Multilayer PWB with high heat dissipation performance. See also (*3)

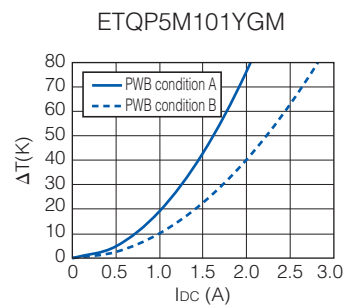
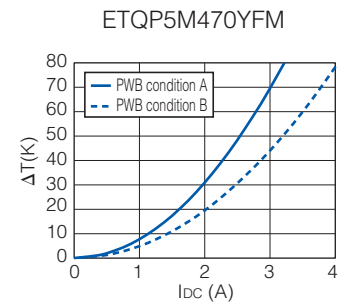
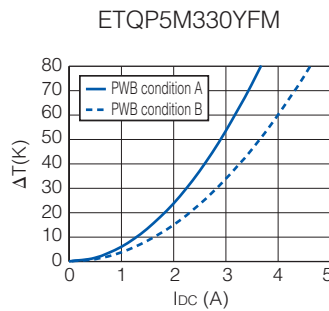
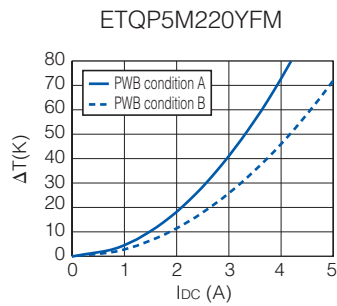
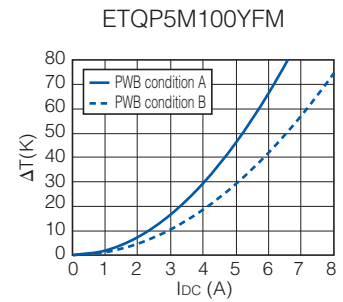
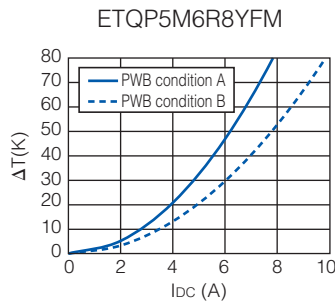
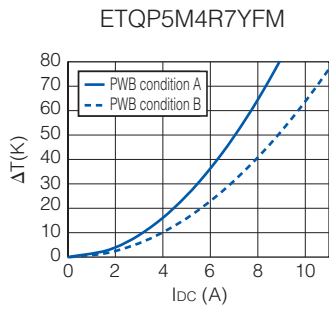

4. Series PCC-M0854M/PCC-M0850M (ETQP5M□□□YFK/ETQP5M□□□YGK)

Standard Parts

Part No.	Inductance *1		DCR (at 20 °C) (mΩ)		Rated Current (Typ. : A)			Series
	L0 (μH)	Tolerance (%)	Typ. (max.)	Tolerance (%)	ΔT=40K		ΔL=-30%	
					(*2)	(*3)		
ETQP5M2R5YFK	2.5	±20	7.60 (8.40)	±10	11.9	14.0	20.1	PCC-M0854M [8.5×8.0×5.4(mm)]
ETQP5M100YFK	10		33.40 (36.80)		5.7	6.7	13.0	
ETQP5M150YFK	15		48.20 (53.10)		4.7	5.5	7.2	
ETQP5M220YFK	22		63.00 (70.00)		4.1	4.8	6.9	
ETQP5M470YFK	48		125.00 (138.00)		2.9	3.4	5.4	
ETQP5M101YGK	100		302.00 (333.00)		1.7	2.1	3.0	PCC-M0850M [8.5×8.0×5.0(mm)]

(*1) Measured at 100 kHz.

(*2) DC current which causes temperature rise of 40 K. Parts are soldered by reflow on four-layer PWB (1.6 mm FR4) and measured at room temperature. See also (*5)

(*3) DC current which causes temperature rise of 40 K. Parts are soldered by reflow on multilayer PWB with high heat dissipation performance. Note: Heat radiation constant are approx. 27 K/W measured on 8.5×8.0×5.4 mm case size and approx. 29 K/W measured on 8.5×8.0×5.0 mm case size. See also (*5)

(*4) Saturation rated current : DC current which causes L(0) drop -30 %.

(*5) Within a suitable application, the part's temperature depends on circuit design and certain heat dissipation conditions. This should be double checked in a worst case operation mode.

In normal case, the max.standard operating temperature of + 150 °C should not be exceeded.

For higher operating temperature conditions, please contact Panasonic representative in your area.

Performance Characteristics (Reference)

● Inductance vs DC Current

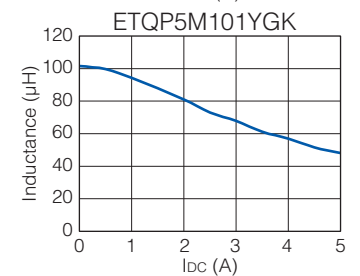
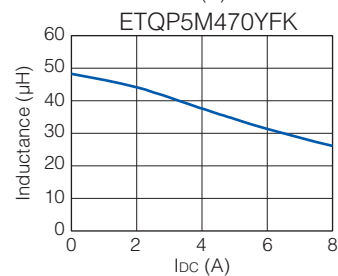
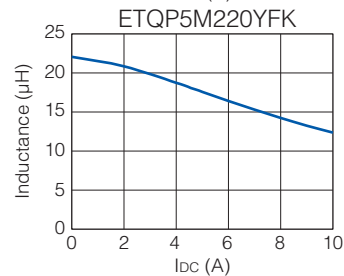
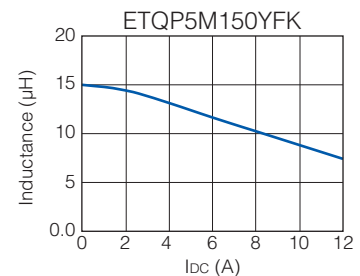
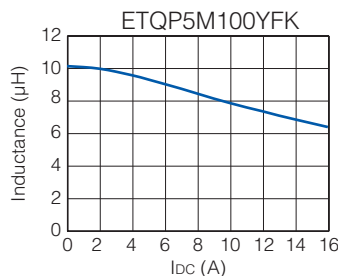
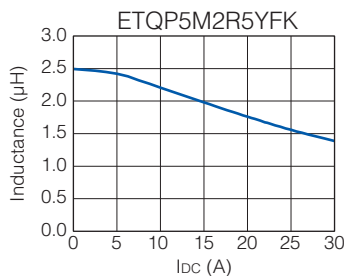

● Case Temperature vs DC Current

PWB condition A : Four-layer PWB (1.6 mm FR4), See also (*2)

PWB condition B : Multilayer PWB with high heat dissipation performance. See also (*3)

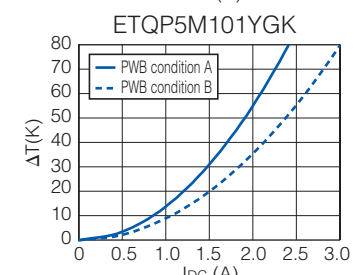
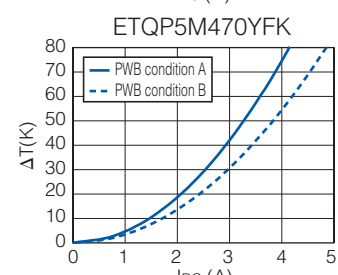
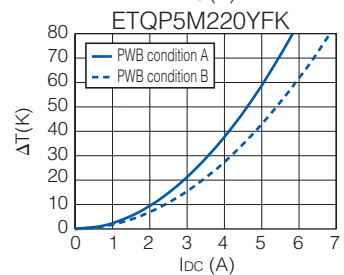
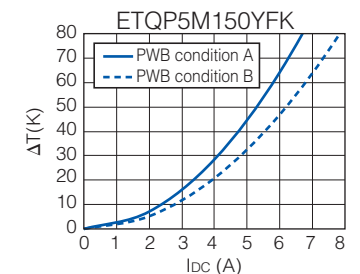
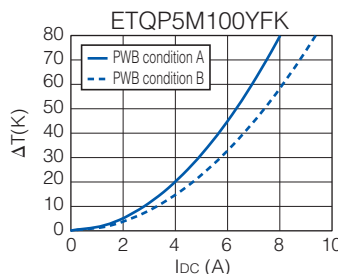
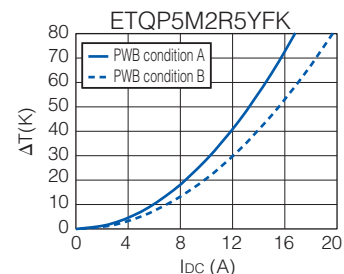

5. Series PCC-M1054M/PCC-M1050M (ETQP5M□□□YFC/ETQP5M□□□YGC)

Standard Parts

Part No.	Inductance *1		DCR (at 20 °C) (mΩ)		Rated Current (Typ. : A)			Series
	L0 (μH)	Tolerance (%)	Typ. (max.)	Tolerance (%)	ΔT=40K		ΔL=-30%	
					(*2)	(*3)		
ETQP5M1R5YFC	1.45	±20	3.80 (4.20)	±10	17.9	21.4	35.1	PCC-M1054M [10.7×10.0×5.4(mm)]
ETQP5M2R5YFC	2.5		5.30 (5.90)		15.1	18.1	27.2	
ETQP5M3R3YFC	3.3		7.10 (7.90)		13.1	15.7	22.7	
ETQP5M4R7YFC	4.7		10.20 (11.30)		10.9	13.1	20.0	
ETQP5M100YFC	10		23.80 (26.20)		7.1	8.5	10.7	
ETQP5M150YFC	15		35.60 (39.16)		5.8	7.0	12.0	
ETQP5M220YFC	22		45.00 (50.00)		5.2	6.2	8.8	
ETQP5M330YFC	32.5		68.50 (75.40)		4.2	5.0	7.6	
ETQP5M470YFC	47		99.00 (108.90)		3.5	4.2	6.8	
ETQP5M680YFC	66	136.00 (149.60)	3.0	3.6	4.9			
ETQP5M101YGC	97		208.00 (229.00)		2.2	2.7	3.0	PCC-M1050M [10.7×10.0×5.0(mm)]

(*1) Measured at 100 kHz.

(*2) DC current which causes temperature rise of 40 K. Parts are soldered by reflow on four-layer PWB (1.6 mm FR4) and measured at room temperature. See also (*5)

(*3) DC current which causes temperature rise of 40 K. Parts are soldered by reflow on multilayer PWB with high heat dissipation performance. Note: Heat radiation constant are approx. 23 K/W measured on 10.7×10.0×5.4 mm case size and approx. 26 K/W measured on 10.7×10.0×5.0 mm case size. See also (*5)

(*4) Saturation rated current : Dc current which causes L(0) drop -30 %.

(*5) Within a suitable application, the part's temperature depends on circuit design and certain heat dissipation conditions. This should be double checked in a worst case operation mode.

In normal case, the max.standard operating temperature of +150 °C should not be exceeded.

For higher operating temperature conditions, please contact Panasonic representative in your area.

Performance Characteristics (Reference)

● Inductance vs DC Current

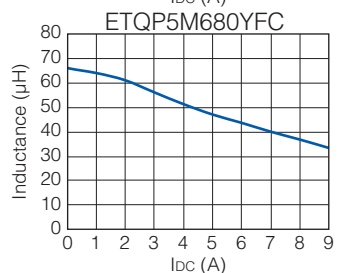
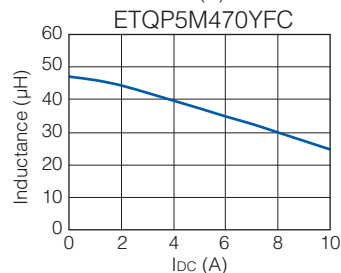
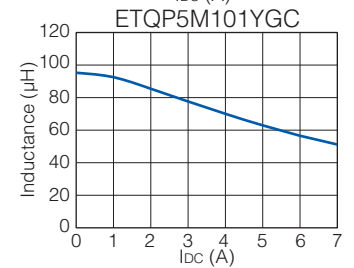
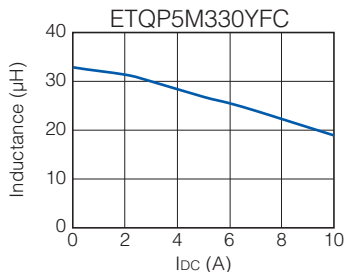
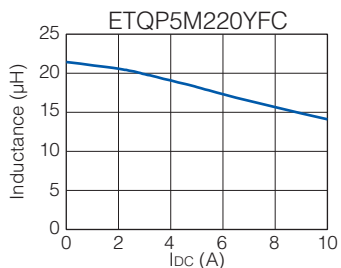
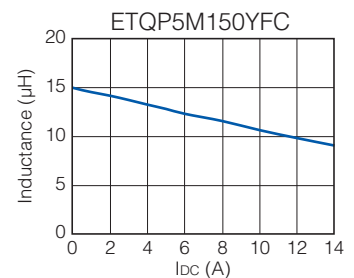
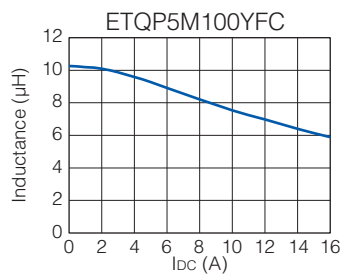
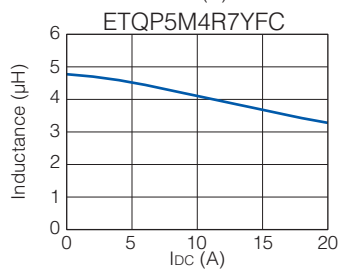
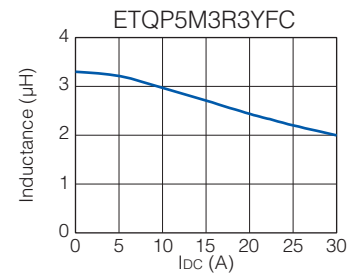
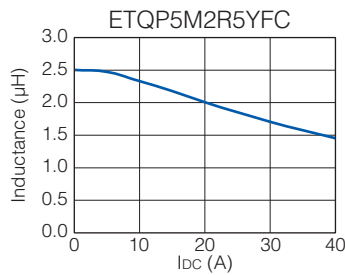
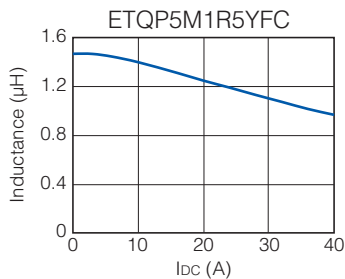

● Case Temperature vs DC Current

PWB condition A : Four-layer PWB (1.6 mm FR4), See also (*2)

PWB condition B : Multilayer PWB with high heat dissipation performance. See also (*3)

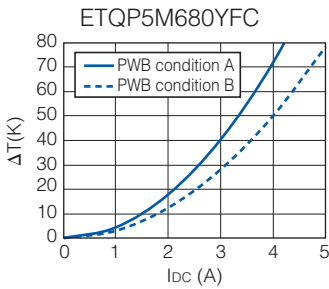
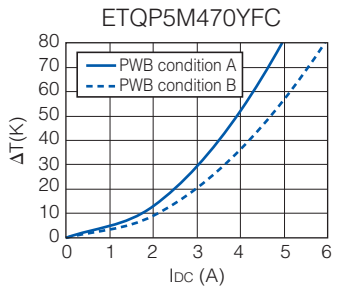
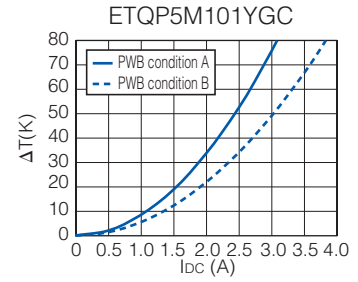
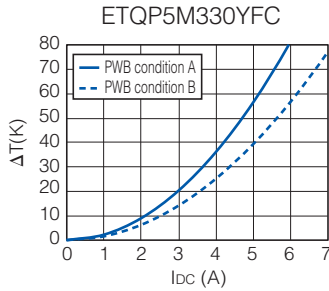
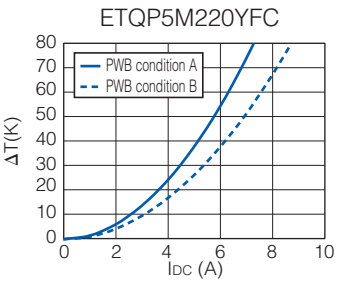
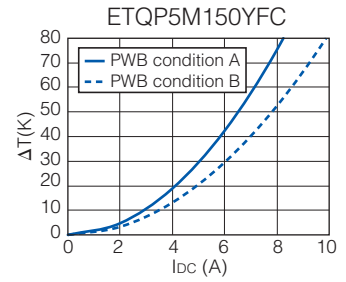
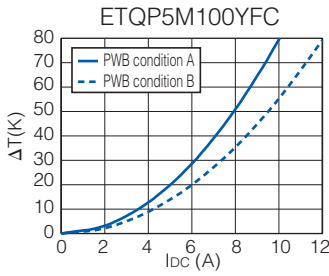
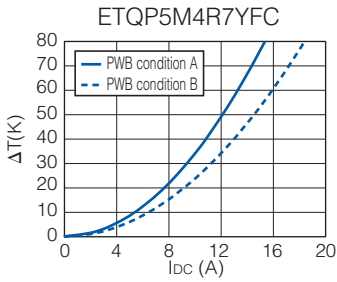
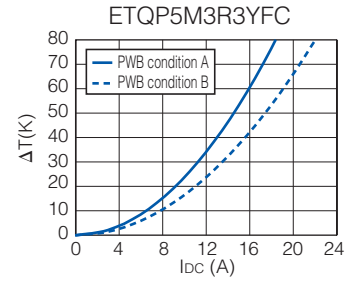
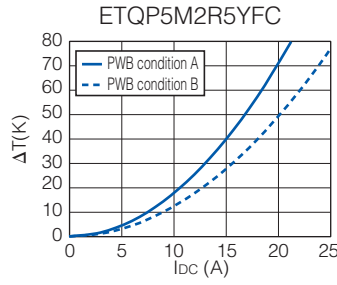
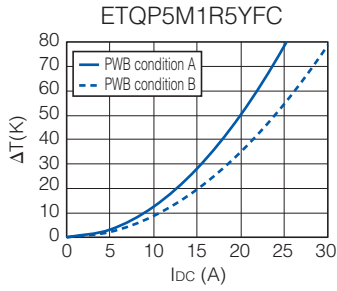

6. Series PCC-M1050ML/PCC-M1060ML (ETQP5M□□□YLC/ETQP6M□□□YLC)

Standard Parts

Part No.	Inductance *1		DCR (at 20 °C) (mΩ)		Rated Current (Typ. : A)			Series
	L0 (μH)	Tolerance (%)	Typ. (max.)	Tolerance (%)	ΔT=40K		ΔL=-30%	
					(*2)	(*3)		
ETQP5MR33YLC	0.33	±20	1.10 (1.21)	±10	33.2	39.7	56.7	PCC-M1050ML [10.9×10.0×5.0(mm)]
ETQP5MR68YLC	0.68		1.75 (1.93)		26.3	31.5	40.0	
ETQP5M1R0YLC	1.0		2.30 (2.53)		23.0	27.5	37.8	
ETQP5M2R0YLC	2.0		4.60 (5.06)		16.2	19.4	31.3	
ETQP6M1R5YLC	1.5		3.20 (3.52)		19.5	23.3	32.0	PCC-M1060ML [10.9×10.0×6.0(mm)]
ETQP6M2R5YLC	2.5		4.55 (5.00)		16.3	19.6	25.8	
ETQP6M3R3YLC	3.3		6.00 (6.60)		14.2	17.0	26.3	
ETQP6M4R7YLC	4.7		8.70 (9.57)		11.8	14.1	22.5	

(*1) Measured at 100 kHz.

(*2) DC current which causes temperature rise of 40 K. Parts are soldered by reflow on four-layer PWB (1.6 mm FR4) and measured at room temperature. See also (*5)

(*3) DC current which causes temperature rise of 40 K. Parts are soldered by reflow on multilayer PWB with high heat dissipation performance. Note: Heat radiation constant are approx. 23 K/W measured on 10.9×10.0×5.0 mm case size and approx. 23 K/W measured on 10.9×10.0×6.0 mm case size. See also (*5)

(*4) Saturation rated current : Dc current which causes L(0) drop -30 %.

(*5) Within a suitable application, the part's temperature depends on circuit design and certain heat dissipation conditions. This should be double checked in a worst case operation mode.

In normal case, the max.standard operating temperature of +150 °C should not be exceeded.

For higher operating temperature conditions, please contact Panasonic representative in your area.

Performance Characteristics (Reference)

● Inductance vs DC Current

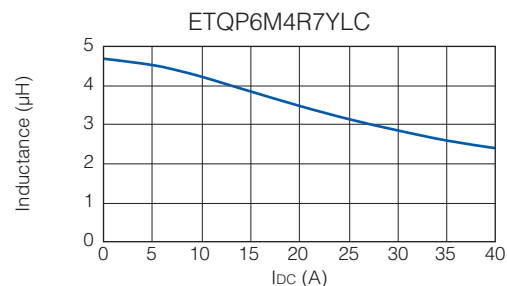
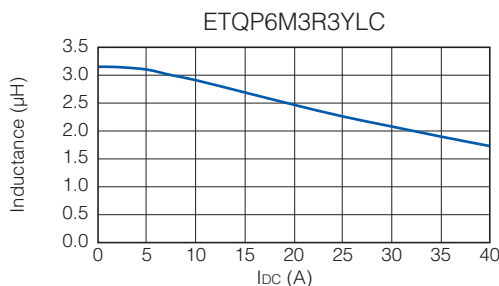
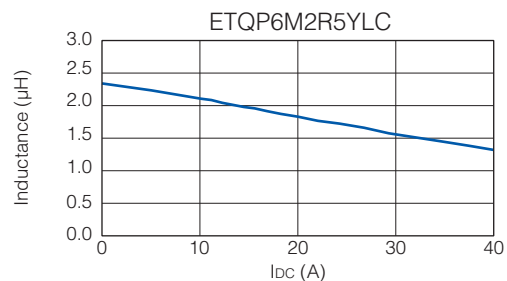
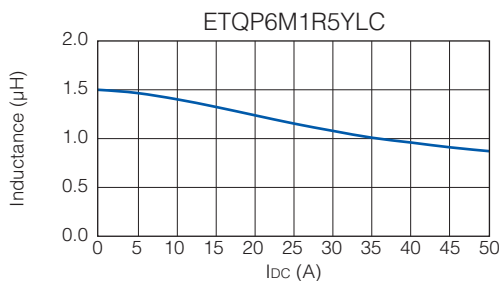
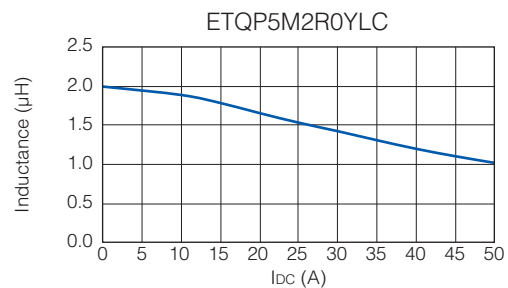
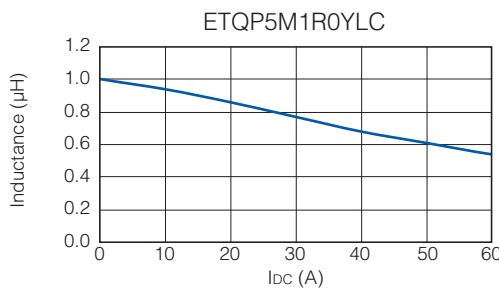
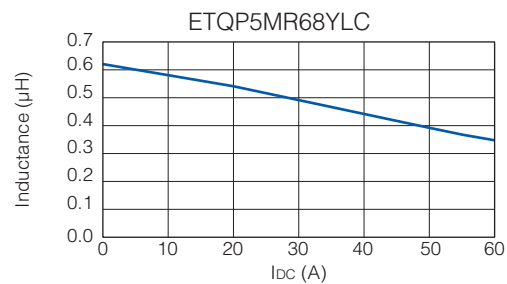
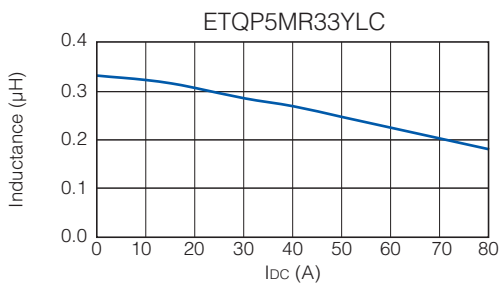

● Case Temperature vs DC Current

PWB condition A : Four-layer PWB (1.6 mm FR4), See also (*2)

PWB condition B : Multilayer PWB with high heat dissipation performance. See also (*3)

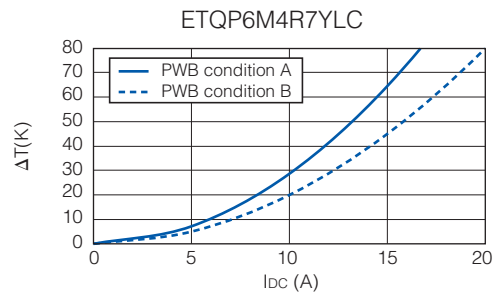
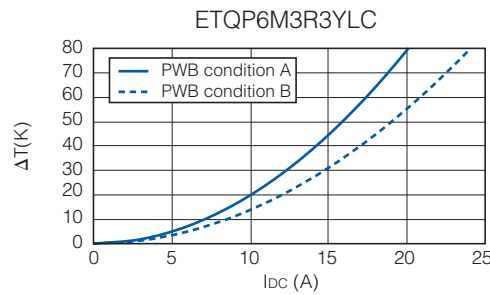
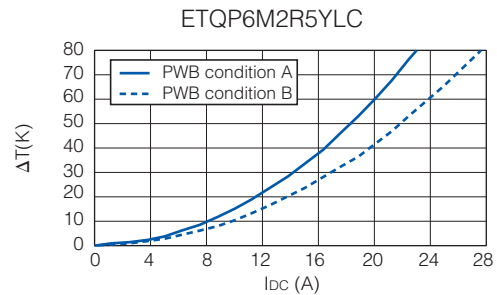
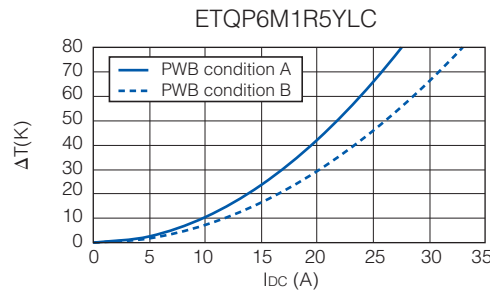
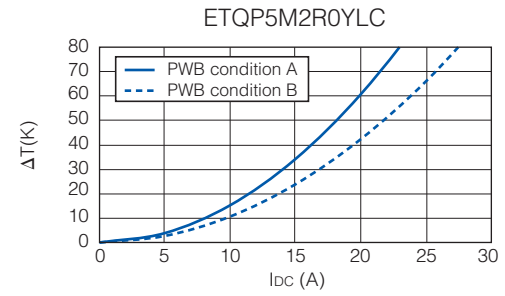
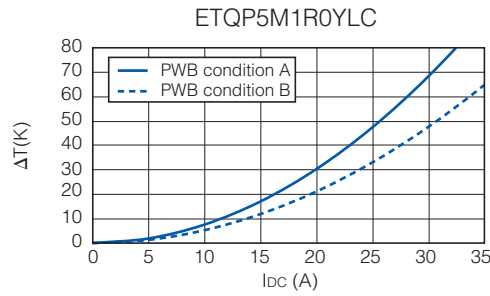
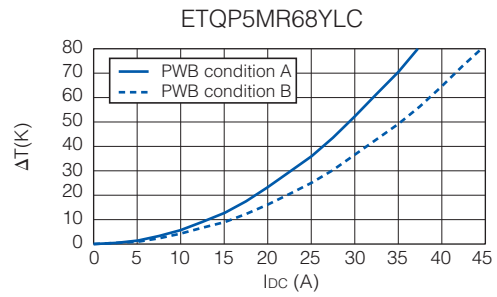
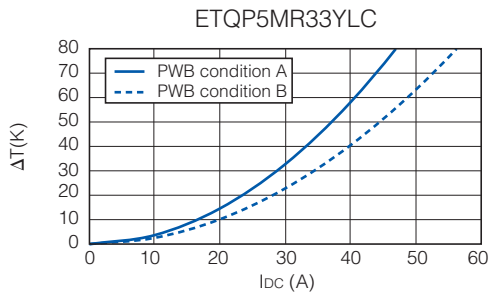

Dimensions in mm (not to scale)

Dimensional tolerance unless noted : ± 0.5

Series PCC-M0530M
Series PCC-M0540M
(ETQP3M□□□YFP/ETQP4M□□□YFP)

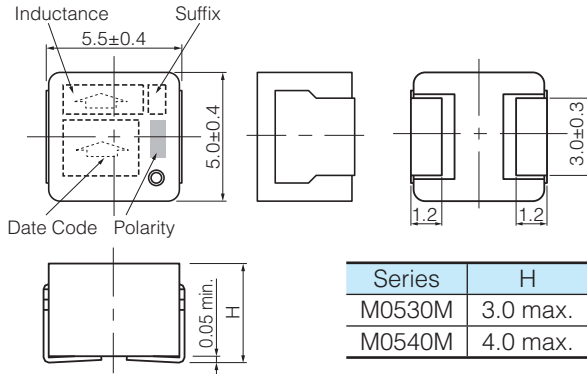

Series PCC-M0630M
Series PCC-M0645M
(ETQP3M□□□YFN/ETQP4M□□□YFN)

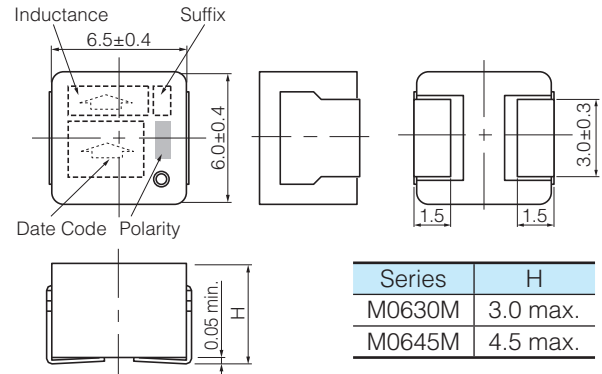

Series PCC-M0754M
Series PCC-M0750M
(ETQP5M□□□YFM/YGM)

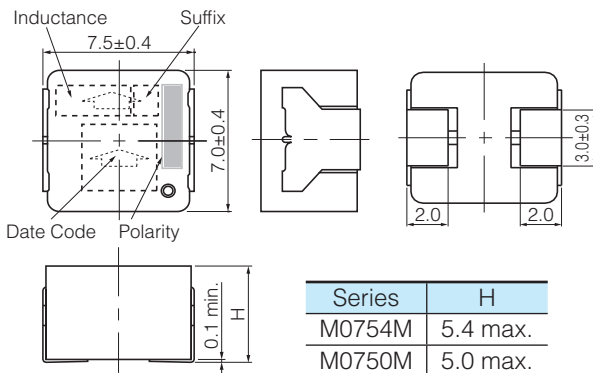

Series PCC-M0854M
Series PCC-M0850M
(ETQP5M□□□YFK/YGK)

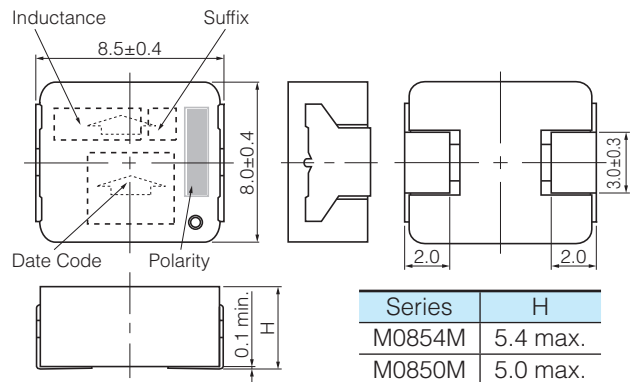

Series PCC-M1054M
Series PCC-M1050M
(ETQP5M□□□YFC/YGC)

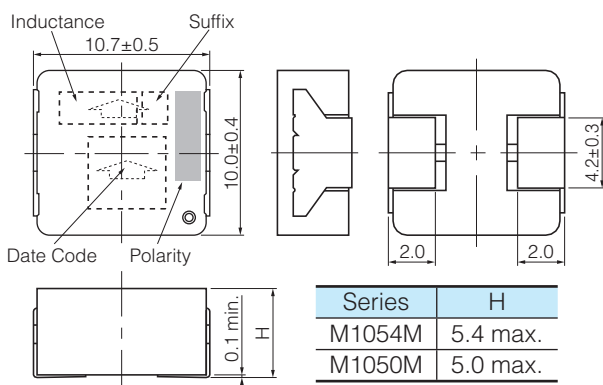

Series PCC-M1050ML
Series PCC-M1060ML
(ETQP5M□□□YLC/ETQP6M□□□YLC)

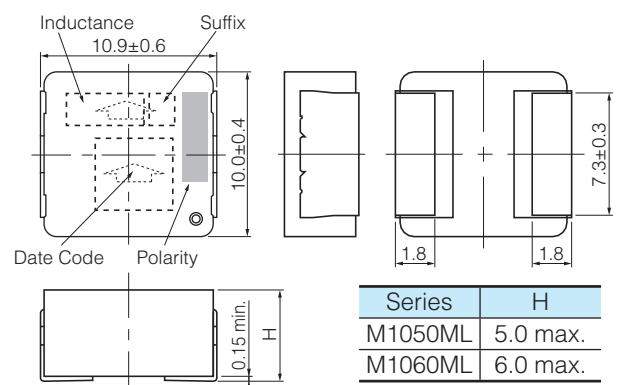

Recommended Land Pattern in mm (not to scale)

Dimensional tolerance unless noted : ± 0.5

Series PCC-M0530M
Series PCC-M0540M
(ETQP3M□□□YFP/ETQP4M□□□YFP)

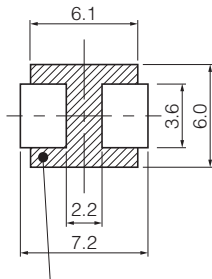

Don't wire on the pattern on shaded portion the PWB.

Series PCC-M0630M
Series PCC-M0645M
(ETQP3M□□□YFN/ETQP4M□□□YFN)

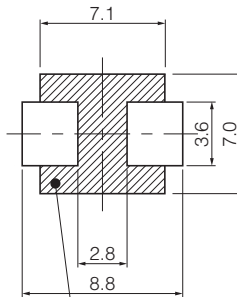

The same as the left.

Series PCC-M0754M
Series PCC-M0750M
(ETQP5M□□□YFM/YGM)

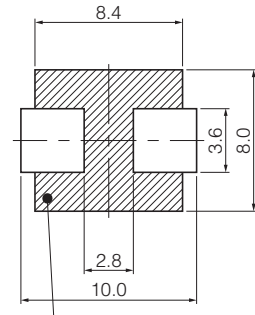

The same as the left.

Series PCC-M0854M
Series PCC-M0850M
(ETQP5M□□□YFK/YGK)

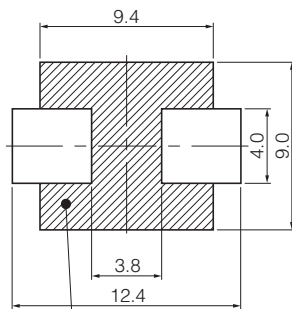

Don't wire on the pattern on shaded portion the PWB.

Series PCC-M1054M
Series PCC-M1050M
(ETQP5M□□□YFC/YGC)

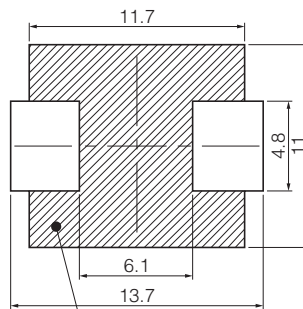

The same as the left.

Series PCC-M1050ML
Series PCC-M1060ML
(ETQP5M□□□YLC/ETQP6M□□□YLC)

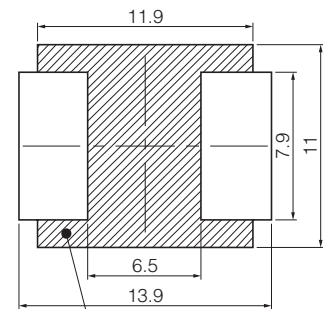

The same as the left.

■ As for Soldering Conditions and Safety Precautions (Power Choke Coils (Automotive Grade)),

Please see Data Files

Packaging Methods (Taping)

- Embossed Carrier Tape Dimensions in mm (not to scale)

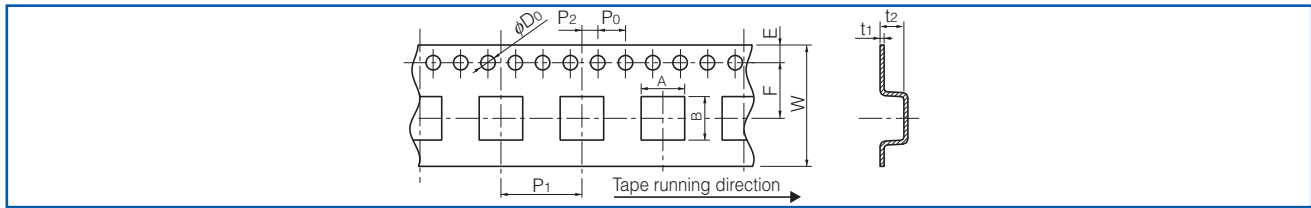

Series	A	B	W	E	F	P ₁	P ₂	P ₀	φD ₀	t ₁	t ₂
PCC-M0530M	5.6	6.1	16.0	1.75	7.5	12.0	2.0	4.0	1.5	0.4	3.3
PCC-M0540M											4.3
PCC-M0630M	7.1	6.6									3.3
PCC-M0645M											5.0
PCC-M0754M/M0750M	8.1	7.6									6.0
PCC-M0854M/M0850M	9.1	8.6									6.0
PCC-M1054M/M1050M PCC-M1050ML/M1060ML	10.65	11.75	24.0	11.5	16.0	0.5	6.35				

- Taping Reel Dimensions in mm (not to scale)

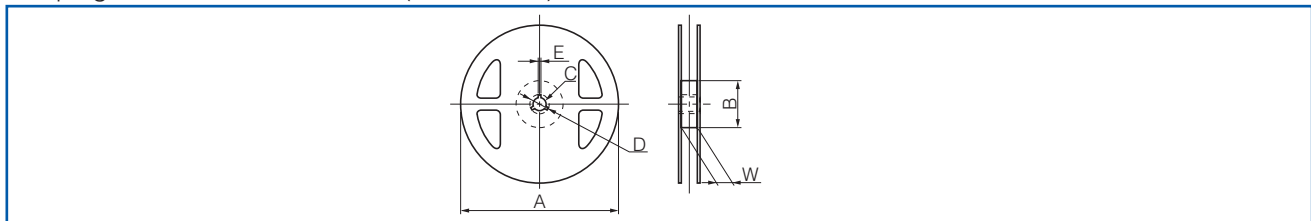

Standard Reel Dimensions

Series	A	B	C	D	E	W
PCC-M0530M/M0540M PCC-M0630M/M0645M PCC-M0754M/M0750M PCC-M0854M/M0850M	330	100	13	21	2	17.5
PCC-M1054M/M1050M PCC-M1050ML/M1060ML						25.5

Component Placement (Taping)

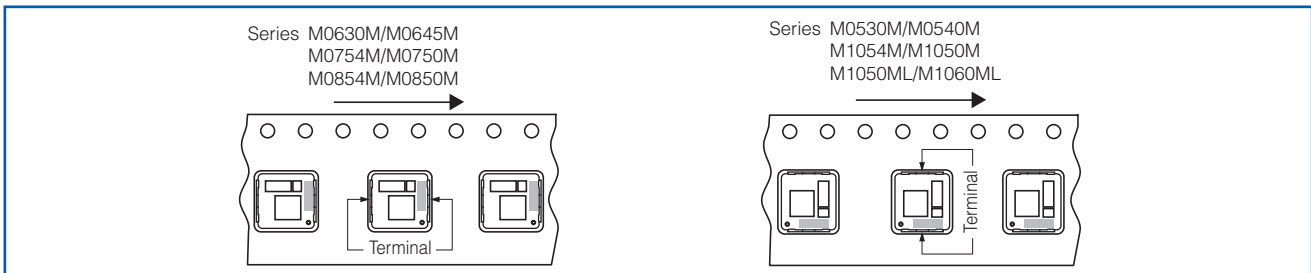

Standard Packing Quantity/Reel

Series	Part No.	Minimum Quantity / Packing Unit	Quantity per reel
PCC-M0530M	ETQP3M□□□YFP	2,000 pcs / box (2 reel)	1,000 pcs
PCC-M0540M	ETQP4M□□□YFP		
PCC-M0630M	ETQP3M□□□YFN		
PCC-M0645M	ETQP4M□□□YFN	1,000 pcs / box (2 reel)	500 pcs
PCC-M0754M	ETQP5M□□□YFM		
PCC-M0750M	ETQP5M□□□YGM		
PCC-M0854M	ETQP5M□□□YFK		
PCC-M0850M	ETQP5M□□□YGK		
PCC-M1054M	ETQP5M□□□YFC		
PCC-M1050M	ETQP5M□□□YGC		
PCC-M1050ML	ETQP5M□□□YLC		
PCC-M1060ML	ETQP6M□□□YLC		

Design and specifications are each subject to change without notice. Ask factory for the current technical specifications before purchase and/or use.
Should a safety concern arise regarding this product, please be sure to contact us immediately.

Power Choke Coil (Automotive Grade)

Series: **PCC-M0854MS (MC)**
PCC-M1050MS (MC)



High heat resistance and high reliability
 Using metal composite core (MC)

Industrial Property : patents 18 (Registered 10/Pending 8)

Features

- The vibration-resistant structure achieves a vibration acceleration-resistance of 50 G or higher in 150 °C environments
- Reduce core loss in high frequency band (More than 2 MHz)
- High heat resistance : Operation up to 150 °C including self-heating
- SMD type
- High-reliability : High vibration resistance as result of newly developed integral construction; under severe reliability conditions of automotive and other strenuous applications
- High bias current : Excellent inductance stability using ferrous alloy magnetic material
- Temp. stability : Excellent inductance stability over broad temp. range
- Low audible (buzz) noise : New metal composite core technology
- High efficiency : Low R_{DC} of winding and low eddy-current loss of the core
- Shielded construction
- AEC-Q200 Automotive qualified
- RoHS compliant

Recommended Applications

- ECU placed in the engine itself, mechanical-electrical-integrated ECU
- Noise filter for various drive circuitry requiring high temp. operation and peak current handling capability
- Boost-Converter, Buck-Converter DC/DC

Standard Packing Quantity (Minimum Quantity/Packing Unit)

- 1,000 pcs/box (2 reel)

Explanation of Part Numbers

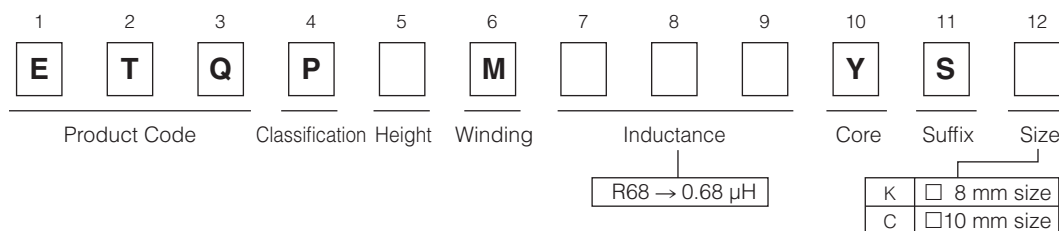

Temperature rating

Operating temperature range		Tc : -40 °C to +150 °C(Including self-temperature rise)
Storage condition	After PWB mounting	
	Before PWB mounting	Ta : -5 °C to +35 °C 85%RH max.

Standard Parts

Part No.	Inductance *1		DCR (at 20 °C) (mΩ)		Rated Current (Typ. : A)			Series
	L0 (μH)	Tolerance (%)	Typ. (max.)	Tolerance (%)	ΔT=40K		ΔL=-30%	
					(*2)	(*3)		
ETQP5M2R5YSK	2.45	±20	7.40 (8.14)	±10	12.0	14.1	21.7	PCC-M0854MS [8.5×8.0×5.4(mm)]
ETQP5MR68YSC	0.68		1.66 (1.83)		27.0	32.3	40.0	PCC-M1050MS [10.9×10.0×5.0(mm)]

(*1) Measured at 100 kHz.

(*2) DC current which causes temperature rise of 40 K. Parts are soldered by reflow on four-layer PWB (1.6 mm FR4) and measured at room temperature. See also (*5)

(*3) DC current which causes temperature rise of 40 K. Parts are soldered by reflow on multilayer PWB with high heat dissipation performance. Note: Heat radiation constant are approx. 30 K/W measured on 8.5×8.0×5.4 mm case size and approx. 20 K/W measured on 10.9×10.0×5.0 mm case size. See also (*5)

(*4) Saturation rated current : Dc current which causes L(0) drop -30 %.

(*5) Within a suitable application, the part's temperature depends on circuit design and certain heat dissipation conditions. This should be double checked in a worst case operation mode.

In normal case, the max.standard operating temperature of +150 °C should not be exceeded.

For higher operating temperature conditions, please contact Panasonic representative in your area.

Performance Characteristics (Reference)

● Inductance vs DC Current

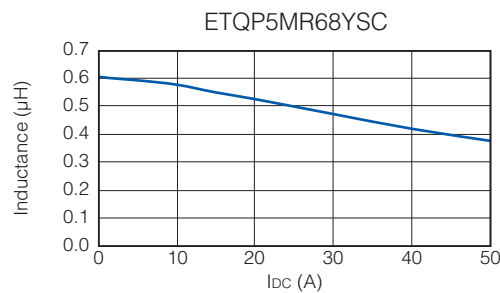
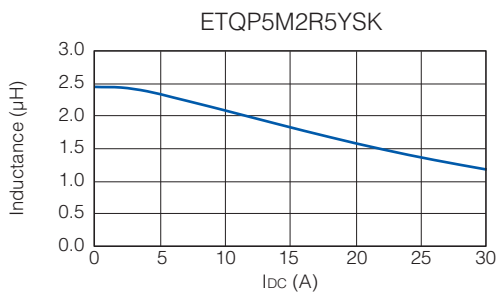

● Case Temperature vs DC Current

PWB condition A : Four-layer PWB (1.6 mm FR4), See also (*2)

PWB condition B : Multilayer PWB with high heat dissipation performance. See also (*3)

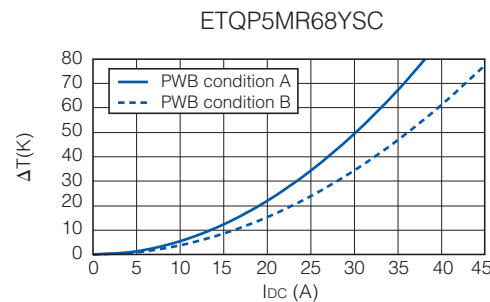
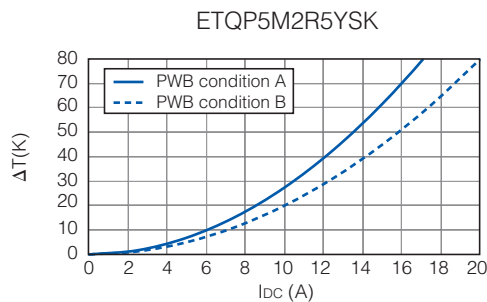

Dimensions in mm (not to scale)

Dimensional tolerance unless noted : ±0.5

Series PCC-M0854MS (ETQP5M□□□YSK)

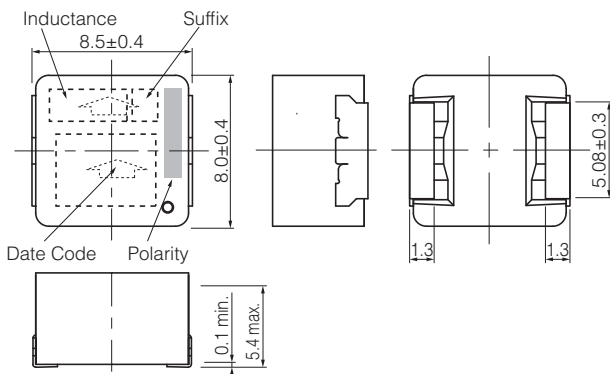

Series PCC-M1050MS (ETQP5M□□□YSC)

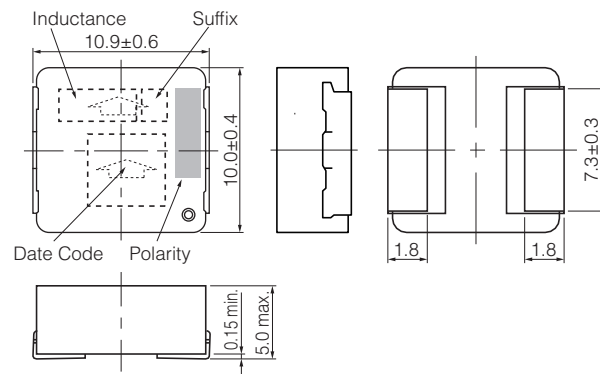

Recommended Land Pattern in mm (not to scale)

Dimensional tolerance unless noted : ± 0.5

Series PCC-M0854MS
(ETQP5M□□□YSK)

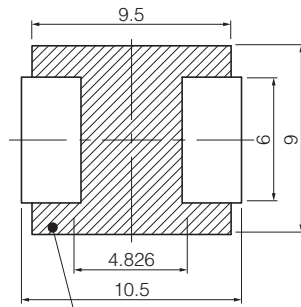

Don't wire on the pattern on shaded portion the PWB.

Series PCC-M1050MS
(ETQP5M□□□YSC)

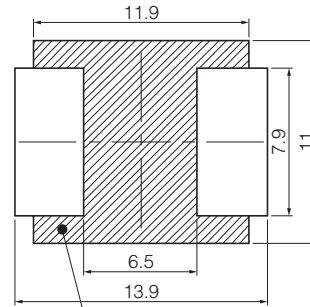

The same as the left.

As for Soldering Conditions and Safety Precautions (Power Choke Coils (Automotive Grade)),

Please see Data Files

Packaging Methods (Taping)

- Embossed Carrier Tape Dimensions in mm (not to scale)

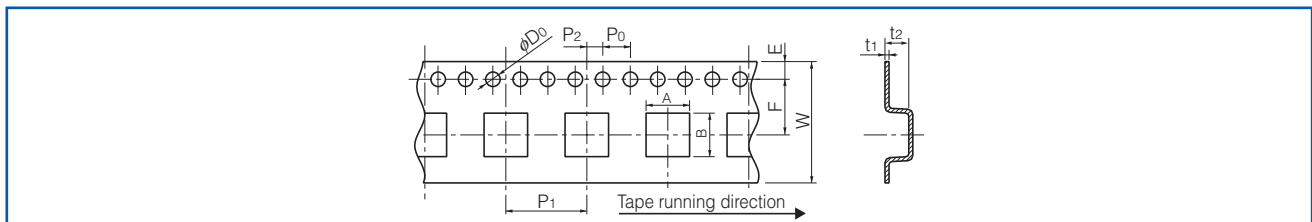

Series	A	B	W	E	F	P ₁	P ₂	P ₀	φD ₀	t ₁	t ₂
PCC-M0854MS	9.1	8.6	16.0	1.75	7.5	12.0	2.0	4.0	1.5	0.4	6.0
PCC-M1050MS	10.65	11.75	24.0		11.5	16.0				0.5	6.35

- Taping Reel Dimensions in mm (not to scale)

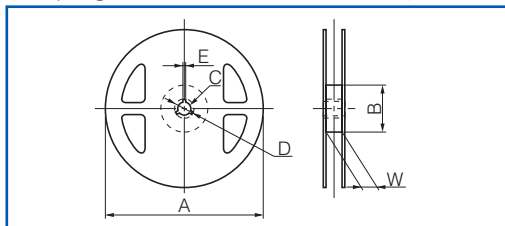

Standard Reel Dimensions

Series	A	B	C	D	E	W
PCC-M0854MS	330	100	13	21	2	17.5
PCC-M1050MS						25.5

Component Placement (Taping)

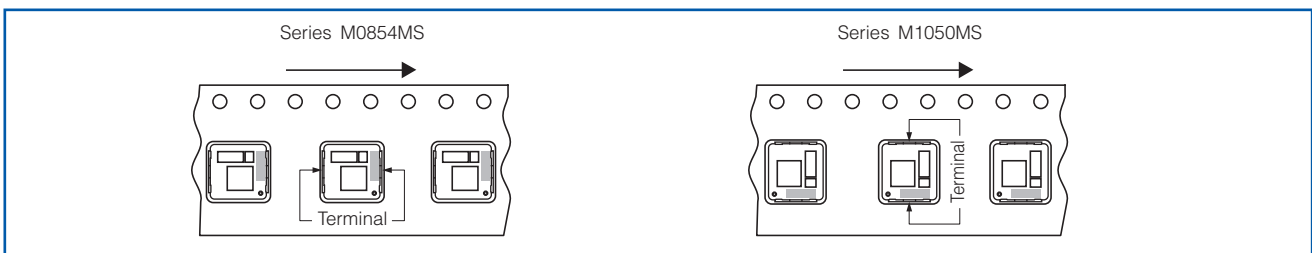

Standard Packing Quantity/Reel

Series	Part No.	Minimum Quantity / Packing Unit	Quantity per reel
PCC-M0854MS	ETQP5M□□□YSK	1,000 pcs / box (2 reel)	500 pcs
PCC-M1050MS	ETQP5M□□□YSC	1,000 pcs / box (2 reel)	500 pcs

Design and specifications are each subject to change without notice. Ask factory for the current technical specifications before purchase and/or use. Should a safety concern arise regarding this product, please be sure to contact us immediately.

Power Choke Coil (Automotive Grade)

Series: **PCC-M1280MF (MC)**



High heat resistance and high reliability
Using metal composite core (MC)

Industrial Property : patents 3 (Registered 1/Pending 2)

Features

- High heat resistance : Operation up to 160 °C including self-heating
- Large current Power : 53 A (R33 type)
- High vibration resistance : 30G
- SMD type
- High-reliability : High vibration resistance as result of newly developed integral construction; under severe reliability conditions of automotive and other strenuous applications
- High bias current : Excellent inductance stability using ferrous alloy magnetic material (Fig.1)
- Temp. stability : Excellent inductance stability over broad temp. range
- Low audible (buzz) noise : New metal composite core technology
- High efficiency : Low R_{DC} of winding and low eddy-current loss of the core
- Shielded construction
- AEC-Q200 Automotive qualified
- RoHS compliant

● Fig.1 Inductance v.s. DC current

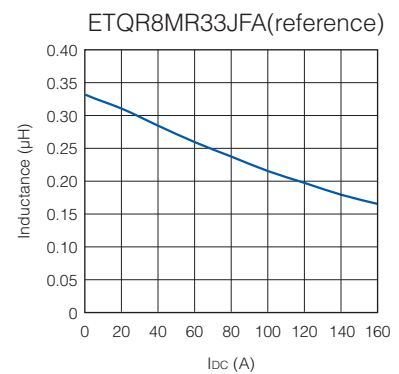

Recommended Applications

- Noise filter for various drive circuitry requiring high temp. operation and peak current handling capability
- Boost-Converter, Buck-Converter DC/DC

Standard Packing Quantity (Minimum Quantity/Packing Unit)

- 500 pcs./box (2 reel)

Explanation of Part Numbers

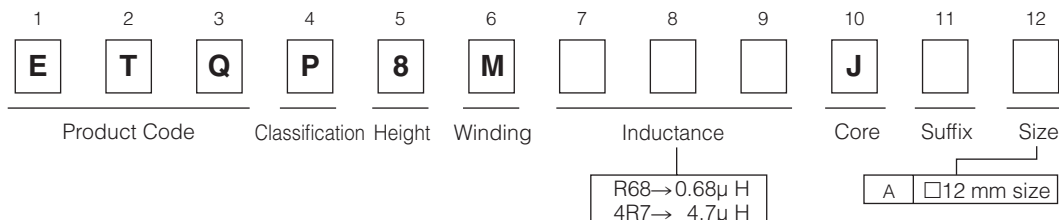

Temperature rating

Operating temperature range		Tc : -40 °C to +160 °C (Including self-temperature rise)
Storage condition	After PWB mounting	
	Before PWB mounting	Ta : -5 °C to +35 °C 85%RH max.

Standard Parts

Series	Part No.	Inductance *1		DCR (at 20 °C) (mΩ)		Rated Current (Typ. : A)		
		L0 (μH)	Tolerance (%)	Typ. (max.)	Tolerance (%)	ΔT=40K		ΔL=-30%
						(*2)	(*3)	(*4)
PCC-M1280MF [12.6×13.2×8.0(mm)]	▲ ETQP8MR33JFA	0.33	±20	0.70 (0.77)	±10	44.4	53.5	84.5
	ETQP8MR68JFA	0.68		1.10 (1.21)		35.4	42.6	56.9
	ETQP8M1R0JFA	1.0		1.36 (1.50)		31.8	38.3	44.4
	ETQP8M1R5JFA	1.5		1.80 (1.98)		27.7	33.3	29.9
	ETQP8M2R5JFA	2.5		2.60 (2.86)		23.0	27.7	32.1
PCC-M1280MF [12.6×13.1×8.0(mm)]	ETQP8M3R3JFA	3.3		3.60 (3.96)		19.6	23.6	27.6
	ETQP8M4R7JFA	4.7		4.90 (5.39)		16.8	20.2	24.7

(*1) Measured at 100k Hz.

▲ Under development

(*2) DC current which causes temperature rise of 40K. Parts are soldered by reflow on four-layer PWB (1.6 mm FR4) and measured at room temperature. See also (*5)

(*3) DC current which causes temperature rise of 40K. Parts are soldered by reflow on multilayer PWB with high heat dissipation performance. Note: Heat radiation constant are approx. 20 K/W measured. See also (*5)

(*4) Saturation rated current : DC current which causes L(0) drop -30 %.

(*5) Within a suitable application, the part's temperature depends on circuit design and certain heat dissipation conditions. This should be double checked in a worst case operation mode.

In normal case, the max.standard operating temperature of +160 °C should not be exceeded.

For higher operating temperature conditions, please contact Panasonic representative in your area.

Performance Characteristics (Reference)

● Inductance vs DC Current

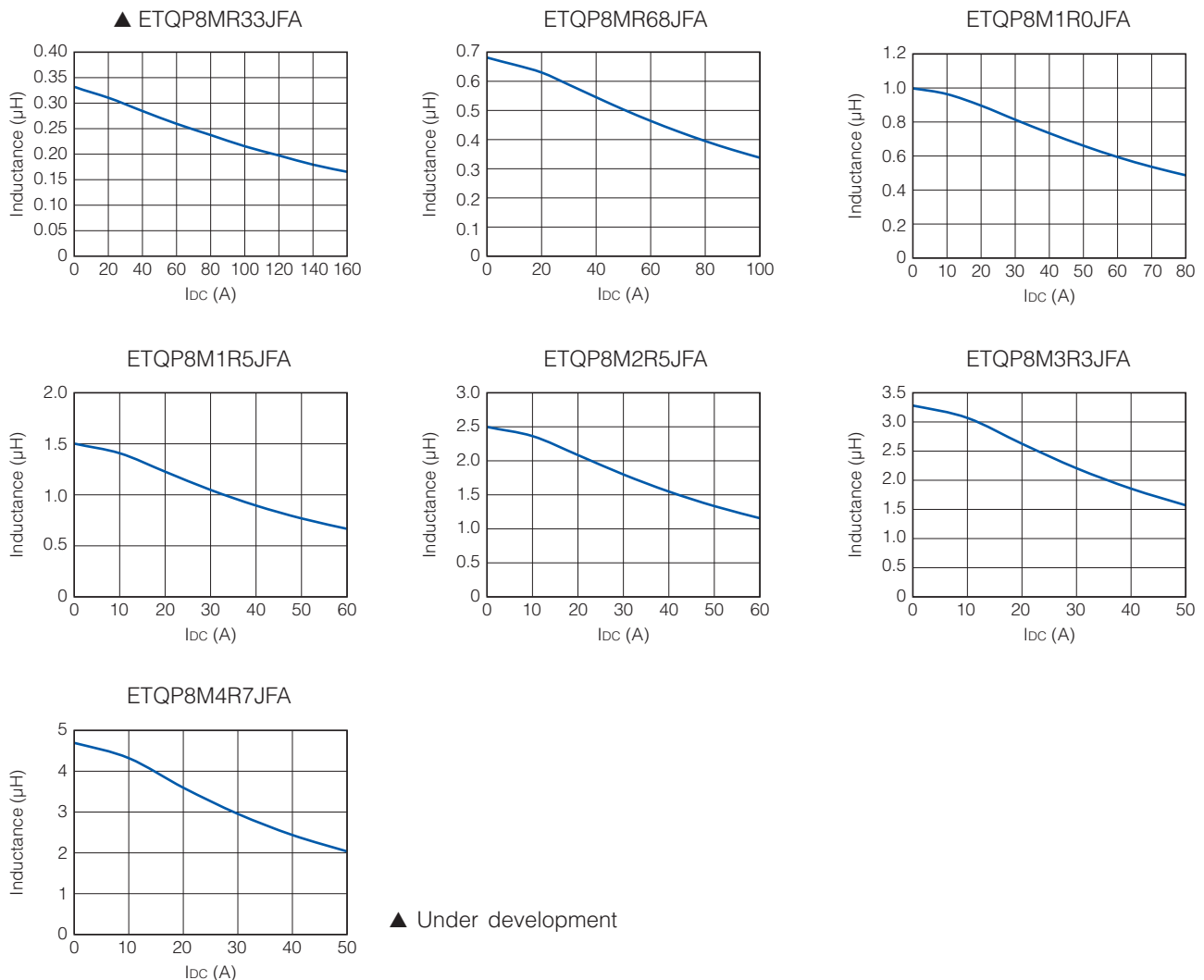

Performance Characteristics (Reference)

● Case Temperature vs DC Current

PWB condition A : Four-layer PWB (1.6 mm FR4), See also (*2)

PWB condition B : Multilayer PWB with high heat dissipation performance. See also (*3)

▲ ETQP8MR33JFA

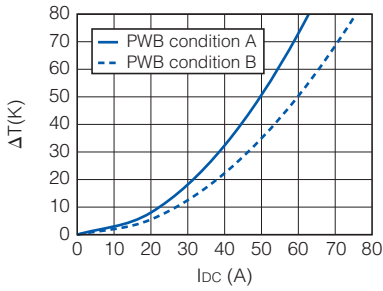

ETQP8MR68JFA

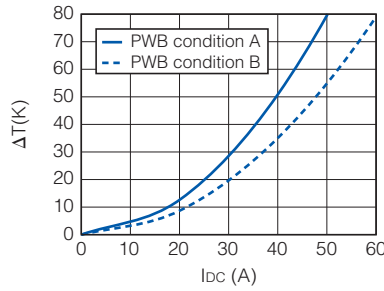

ETQP8M1R0JFA

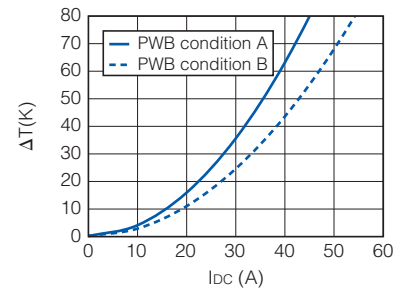

ETQP8M1R5JFA

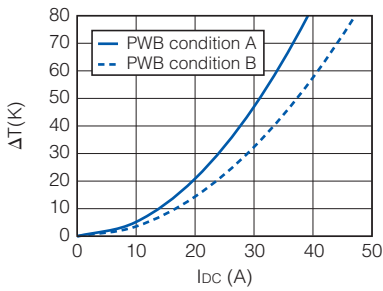

ETQP8M2R5JFA

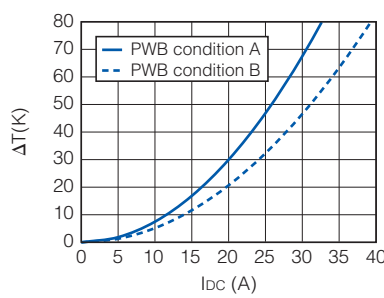

ETQP8M3R3JFA

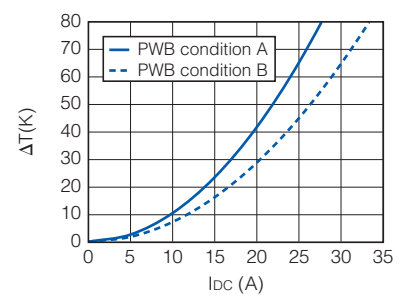

ETQP8M4R7JFA

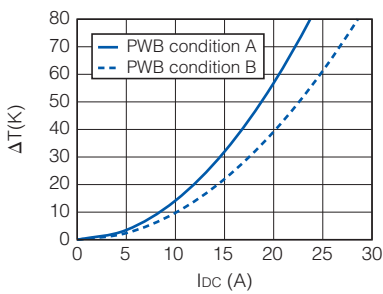

▲ Under development

Dimensions in mm (not to scale)

Dimensional tolerance unless noted : ± 0.5

- ETQP8MR33JFA
- ETQP8M1R5JFA
- ETQP8M3R3JFA
- ETQP8MR68JFA
- ETQP8M2R5JFA
- ETQP8M4R7JFA
- ETQP8M1R0JFA

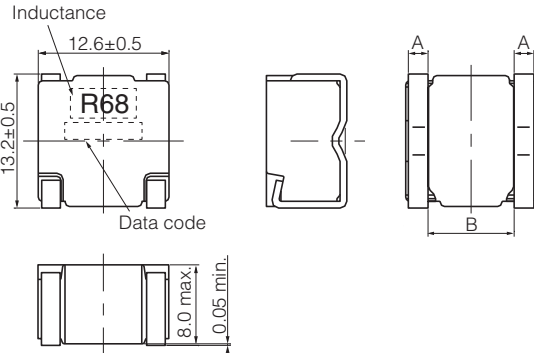

Part No.	A	B
ETQP8MR33JFA	2.25±0.2	7.3±1.0
ETQP8MR68JFA	2.1±0.4	8.0±1.0
ETQP8M1R0JFA	2.1±0.4	8.0±1.0
ETQP8M1R5JFA	2.1±0.4	8.0±1.0
ETQP8M2R5JFA	1.8±0.4	8.6±0.85

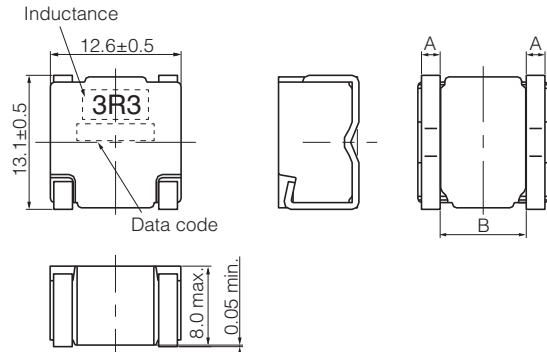

Part No.	A	B
ETQP8M3R3JFA	1.5±0.4	8.8±1.05
ETQP8M4R7JFA	1.25±0.4	9.0±1.25

Recommended Land Pattern in mm (not to scale)

Dimensional tolerance unless noted : ± 0.5

● ETQP8MR33JFA

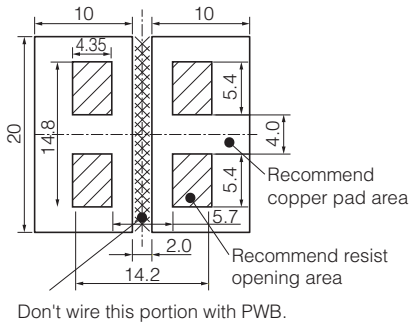

● ETQP8M4R7JFA

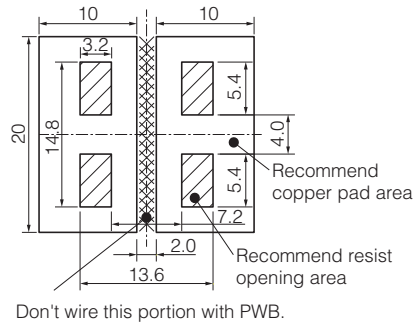

● ETQP8M3R3JFA

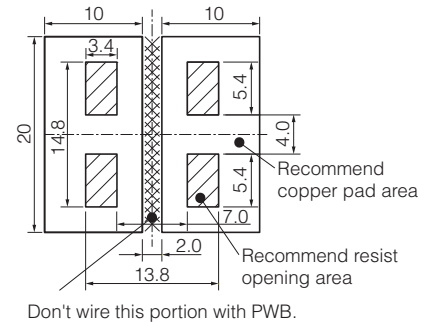

● ETQP8M2R5JFA

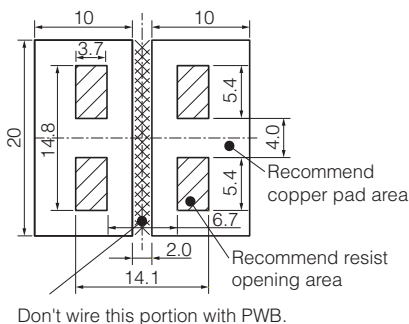

● ETQP8MR68JFA

● ETQP8M1R0JFA

● ETQP8M1R5JFA

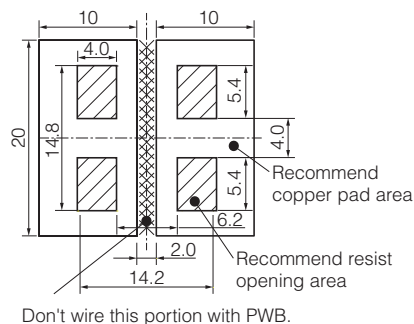

■ As for Soldering Conditions and Safety Precautions (Power Choke Coils (Automotive Grade)),

Please see Data Files

Packaging Methods (Taping)

- Embossed Carrier Tape Dimensions in mm (not to scale)
- Component Placement (Taping)

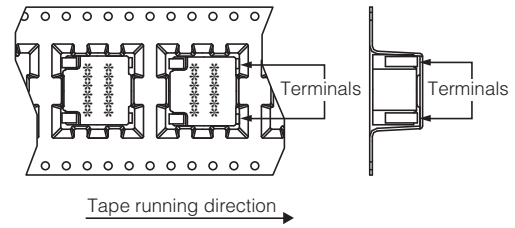
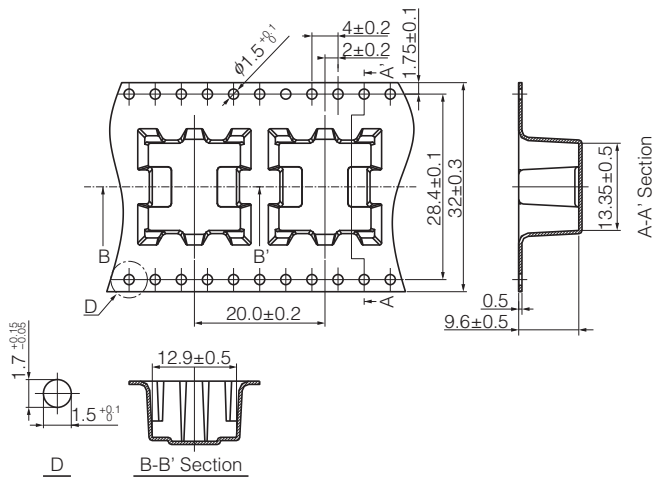

- Taping Reel Dimensions in mm (not to scale)

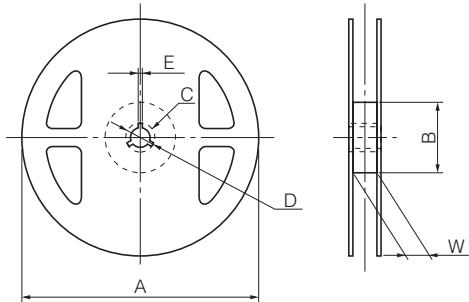

Standard Reel Dimensions

Series	A	B	C	D	E	W
PCC-M1280MF	330	(100)	13	21	2	33.5

Power Choke Coil (Automotive Grade)

Series: **PCC-M0530M-LP(MC)**
PCC-M0630M-LP(MC)
PCC-M0840M-LP(MC)
PCC-M1040M-LP(MC)



High heat resistance and high reliability
 Using metal composite core (MC)

Industrial Property : patents 3 (Registered 2/Pending 1)

Features

- High heat resistance : Operation up to 155 °C including self-heating
- Low profile : 3 mm max. height (PCC-M0530M-LP, PCC-M0630M-LP)
4 mm max. height (PCC-M0840M-LP, PCC-M1040M-LP)
- SMD type
- High-reliability : High vibration resistance as result of newly developed integral construction; under severe reliability conditions of automotive and other strenuous applications
- High bias current : Excellent inductance stability using ferrous alloy magnetic material (Fig.1)
- Temp. stability : Excellent inductance stability over broad temp. range
- Low audible (buzz) noise : A gapless structure achieved with metal composite core
- High efficiency : Low DC resistance of winding and low eddy-current loss of the core
- Shielded construction
- AEC-Q200 Automotive qualified
- RoHS compliant

● Fig.1 Inductance v.s. DC current

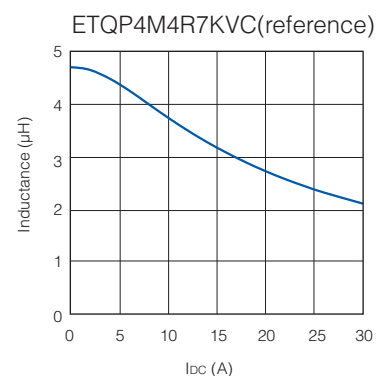

Recommended Applications

- Noise filter for various drive circuitry requiring high temp. operation and peak current handling capability
- Boost-Converter, Buck-Converter DC/DC

Standard Packing Quantity (Minimum Quantity/Packing Unit)

- 4,000 pcs/box (2 reel) : PCC-M0530M-LP, PCC-M0630M-LP
- 1,000 pcs/box (2 reel) : PCC-M0840M-LP, PCC-M1040M-LP

Explanation of Part Numbers

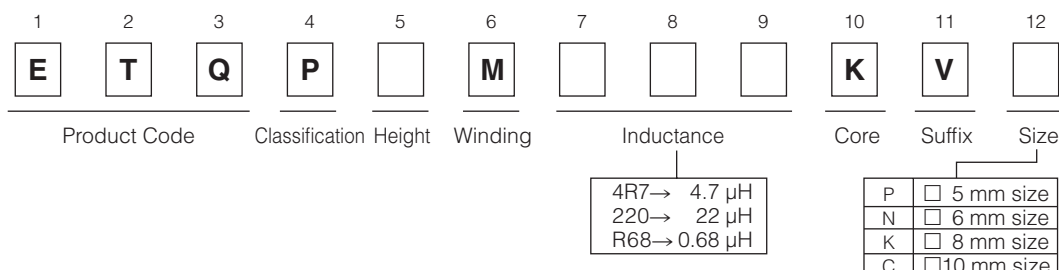

Temperature rating

Operating temperature range		Tc : -55 °C to +155 °C(Including self-temperature rise)
Storage condition	After PWB mounting	
	Before PWB mounting	Ta : -5 °C to +35 °C 85%RH max.

Design and specifications are each subject to change without notice. Ask factory for the current technical specifications before purchase and/or use.
 Should a safety concern arise regarding this product, please be sure to contact us immediately.

1. Series PCC-M0530M-LP (ETQP3M□□□KVP)

Standard Parts

Part No.	Inductance *1		DCR (at 20 °C) (mΩ)		Rated Current (Typ. : A)			Series
	L0 (μH)	Tolerance (%)	Typ. (max.)	Tolerance (%)	ΔT=40K		ΔL=-30%	
					(*2)	(*3)	(*4)	
ETQP3M100KVP	10.00	±20	96.00 (105.60)	±10	2.4	2.9	4.2	PCC-M0530M-LP [5.5×5.0×3.0(mm)]
ETQP3M6R8KVP	6.80		65.70 (72.27)		2.9	3.5	6.1	
ETQP3M4R7KVP	4.70		45.60 (50.16)		3.4	4.1	6.7	
ETQP3M3R3KVP	3.30		27.30 (30.03)		4.4	5.4	8.0	
ETQP3M2R2KVP	2.20		20.00 (22.00)		5.2	6.3	10.1	
ETQP3M1R5KVP	1.50		12.00 (13.20)		6.7	8.1	12.0	
ETQP3M1R0KVP	1.00		9.60 (10.56)		7.5	9.0	14.1	
ETQP3MR68KVP	0.68		7.60 (8.36)		8.4	10.2	15.9	
ETQP3MR33KVP	0.33		4.85 (5.34)		10.6	12.7	21.8	

(*1) Measured at 100k Hz.

(*2) DC current which causes temperature rise of 40K. Parts are soldered by reflow on four-layer PWB (1.6 mm FR4) and measured at room temperature. See also (*5)

(*3) DC current which causes temperature rise of 40K. Parts are soldered by reflow on multilayer PWB with high heat dissipation performance. Note: Heat radiation constant are approx. 51 K/W measured on 5.5×5.0×3.0 mm case size. See also (*5)

(*4) Saturation rated current : DC current which causes L(0) drop -30 %.

(*5) Within a suitable application, the part's temperature depends on circuit design and certain heat dissipation conditions. This should be double checked in a worst case operation mode.

In normal case, the max.standard operating temperature of +155 °C should not be exceeded.

For higher operating temperature conditions, please contact Panasonic representative in your area.

Performance Characteristics (Reference)

● Inductance vs DC Current

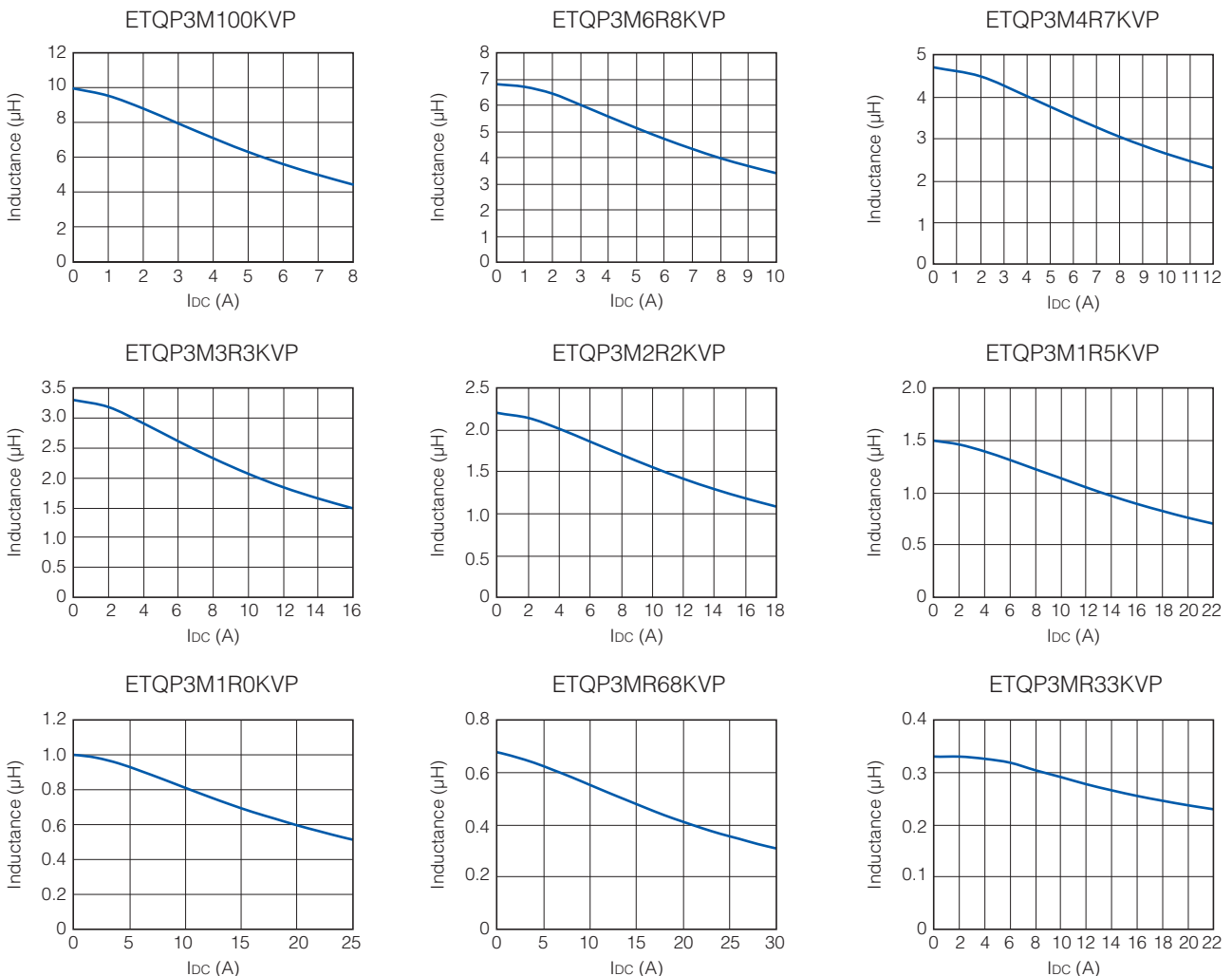

Performance Characteristics (Reference)

● Case Temperature vs DC Current

PWB condition A : Four-layer PWB (1.6 mm FR4), See also (*2)

PWB condition B : Multilayer PWB with high heat dissipation performance. See also (*3)

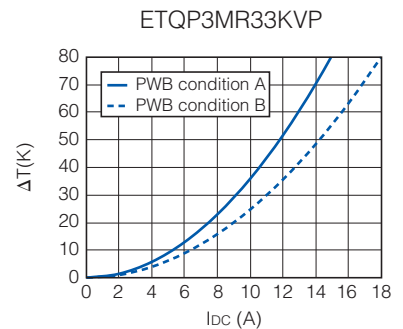
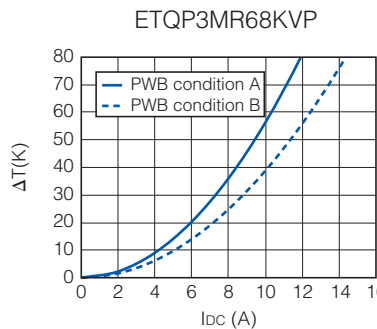
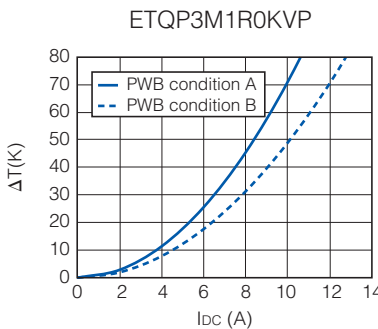
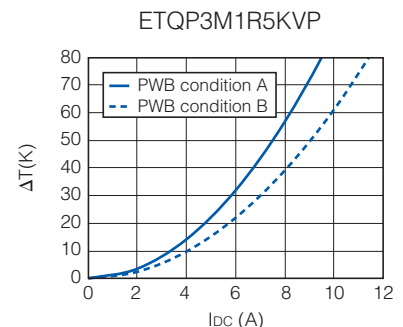
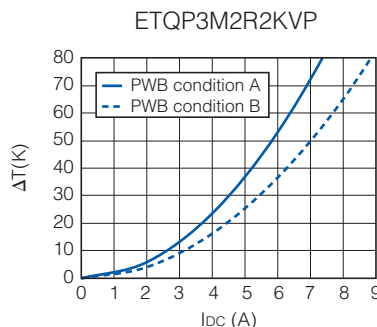
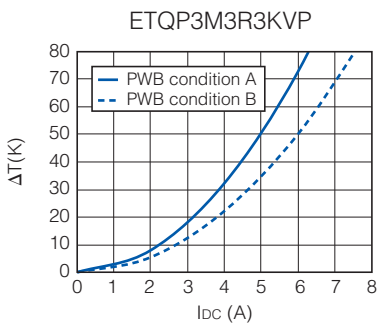
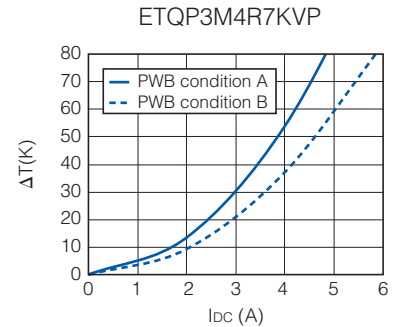
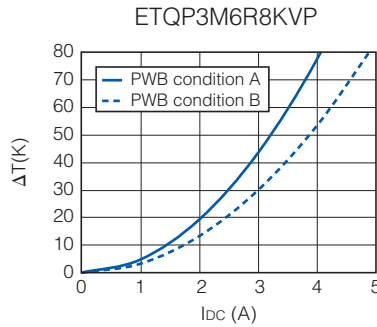
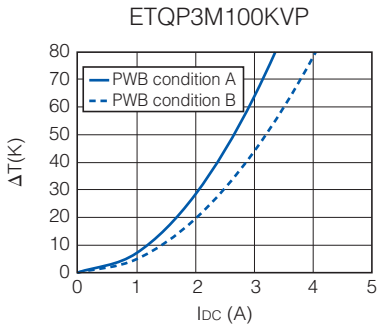

2. Series PCC-M0630M-LP (ETQP3M□□□KVN)

Standard Parts

Part No.	Inductance *1		DCR (at 20 °C) (mΩ)		Rated Current (Typ. : A)			Series
	L0 (μH)	Tolerance (%)	Typ. (max.)	Tolerance (%)	ΔT=40K		ΔL=-30%	
					(*2)	(*3)	(*4)	
ETQP3M330KVN	33.00	±20	206.00 (226.60)	±10	1.7	2.1	3.0	PCC-M0630M-LP [6.4×6.0×3.0(mm)]
ETQP3M220KVN	22.00		128.00 (140.80)		2.2	2.7	4.3	
ETQP3M150KVN	15.00		99.20 (109.12)		2.5	3.0	5.1	
ETQP3M100KVN	10.00		71.00 (78.10)		2.9	3.6	5.8	
ETQP3M6R8KVN	6.80		45.60 (50.16)		3.6	4.5	8.1	
ETQP3M4R7KVN	4.70		29.00 (31.90)		4.6	5.6	9.8	
ETQP3M3R3KVN	3.30		24.10 (26.51)		5.0	6.1	11.5	
ETQP3M2R2KVN	2.20		14.50 (15.95)		6.5	7.9	12.8	
ETQP3M1R5KVN	1.50		11.00 (12.10)		7.4	9.1	14.2	
ETQP3M1R0KVN	1.00		6.20 (6.82)		9.9	12.1	16.0	
ETQP3MR68KVN	0.68	5.20 (5.72)	10.8	13.2	20.2			

(*1) Measured at 100k Hz.

(*2) DC current which causes temperature rise of 40K. Parts are soldered by reflow on four-layer PWB (1.6 mm FR4) and measured at room temperature. See also (*5)

(*3) DC current which causes temperature rise of 40K. Parts are soldered by reflow on multilayer PWB with high heat dissipation performance. Note: Heat radiation constant are approx. 44 K/W measured on 6.5×6.0×3.0 mm case size. See also (*5)

(*4) Saturation rated current : DC current which causes L(0) drop -30 %.

(*5) Within a suitable application, the part's temperature depends on circuit design and certain heat dissipation conditions. This should be double checked in a worst case operation mode.

In normal case, the max.standard operating temperature of +155 °C should not be exceeded.

For higher operating temperature conditions, please contact Panasonic representative in your area.

Performance Characteristics (Reference)

● Inductance vs DC Current

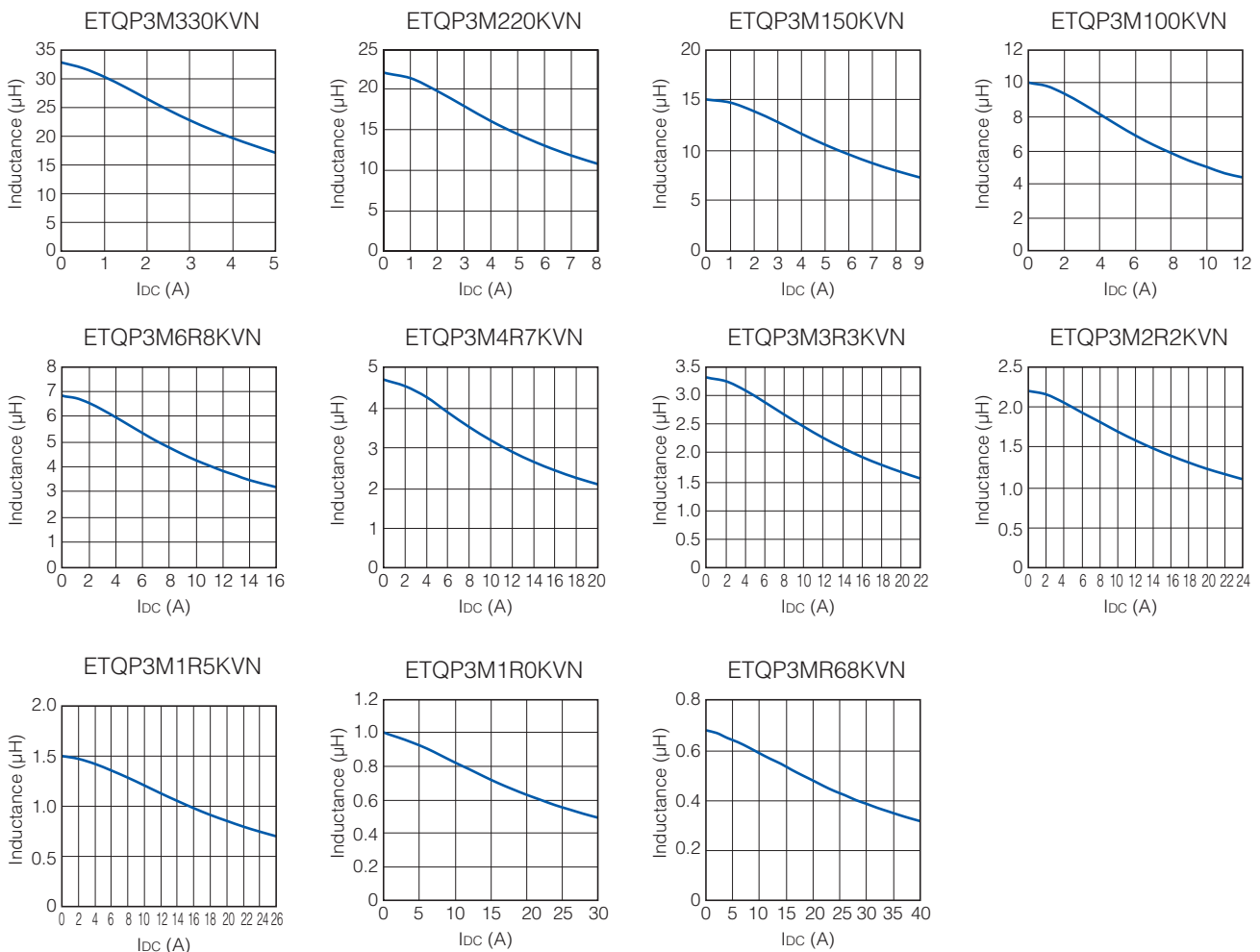

Performance Characteristics (Reference)

● Case Temperature vs DC Current

PWB condition A : Four-layer PWB (1.6 mm FR4), See also (*2)

PWB condition B : Multilayer PWB with high heat dissipation performance. See also (*3)

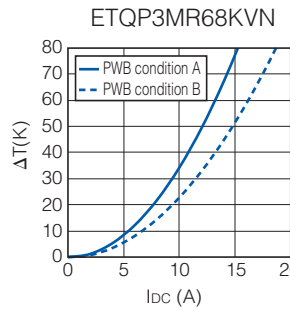
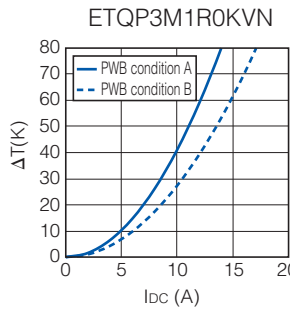
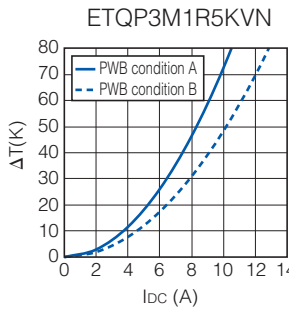
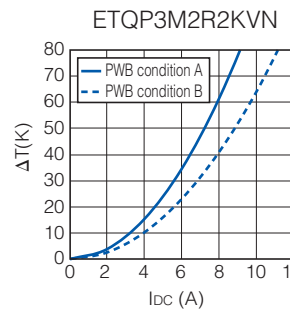
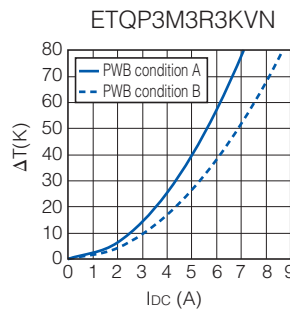
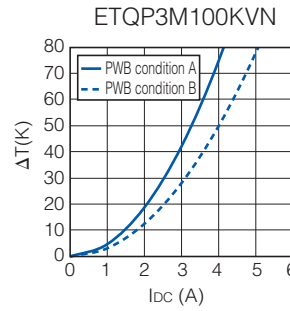
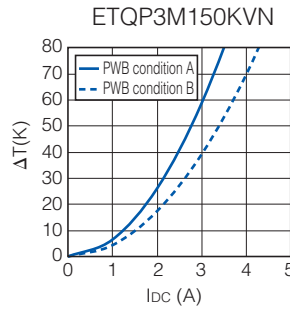

3. Series PCC-M0840M-LP (ETQP4M□□□KVK)

Standard Parts

Part No.	Inductance *1		DCR (at 20 °C) (mΩ)		Rated Current (Typ. : A)			Series
	L0 (μH)	Tolerance (%)	Typ. (max.)	Tolerance (%)	ΔT=40K		ΔL=-30%	
					(*2)	(*3)	(*4)	
ETQP4M330KVK	33.00	±20	118.00 (129.80)	±10	2.6	3.1	4.7	PCC-M0840M-LP [8.5×8.0×4.0(mm)]
ETQP4M220KVK	22.00		78.40 (86.24)		3.2	3.8	6.0	
ETQP4M150KVK	15.00		55.00 (60.50)		3.8	4.5	7.6	
ETQP4M100KVK	10.00		41.60 (45.76)		4.4	5.2	9.1	
ETQP4M6R8KVK	6.80		23.50 (25.85)		5.9	6.9	11.0	
ETQP4M4R7KVK	4.70		16.10 (17.71)		7.1	8.3	15.1	
ETQP4M3R3KVK	3.30		14.10 (15.51)		7.6	8.9	17.4	
ETQP4M2R2KVK	2.20		8.50 (9.35)		9.8	11.4	20.4	
ETQP4M1R5KVK	1.50		4.90 (5.39)		12.8	15.1	22.5	
ETQP4M1R0KVK	1.00		3.70 (4.07)		14.8	17.3	24.4	
ETQP4MR68KVK	0.68	2.92 (3.21)	16.6	19.5	29.0			

(*1) Measured at 100k Hz.

(*2) DC current which causes temperature rise of 40K. Parts are soldered by reflow on four-layer PWB (1.6 mm FR4) and measured at room temperature. See also (*5)

(*3) DC current which causes temperature rise of 40K. Parts are soldered by reflow on multilayer PWB with high heat dissipation performance. Note: Heat radiation constant are approx. 36 K/W measured on 8.5×8.0×4.0 mm case size. See also (*5)

(*4) Saturation rated current : DC current which causes L(0) drop -30 %.

(*5) Within a suitable application, the part's temperature depends on circuit design and certain heat dissipation conditions. This should be double checked in a worst case operation mode.

In normal case, the max.standard operating temperature of +155 °C should not be exceeded.

For higher operating temperature conditions, please contact Panasonic representative in your area.

Performance Characteristics (Reference)

● Inductance vs DC Current

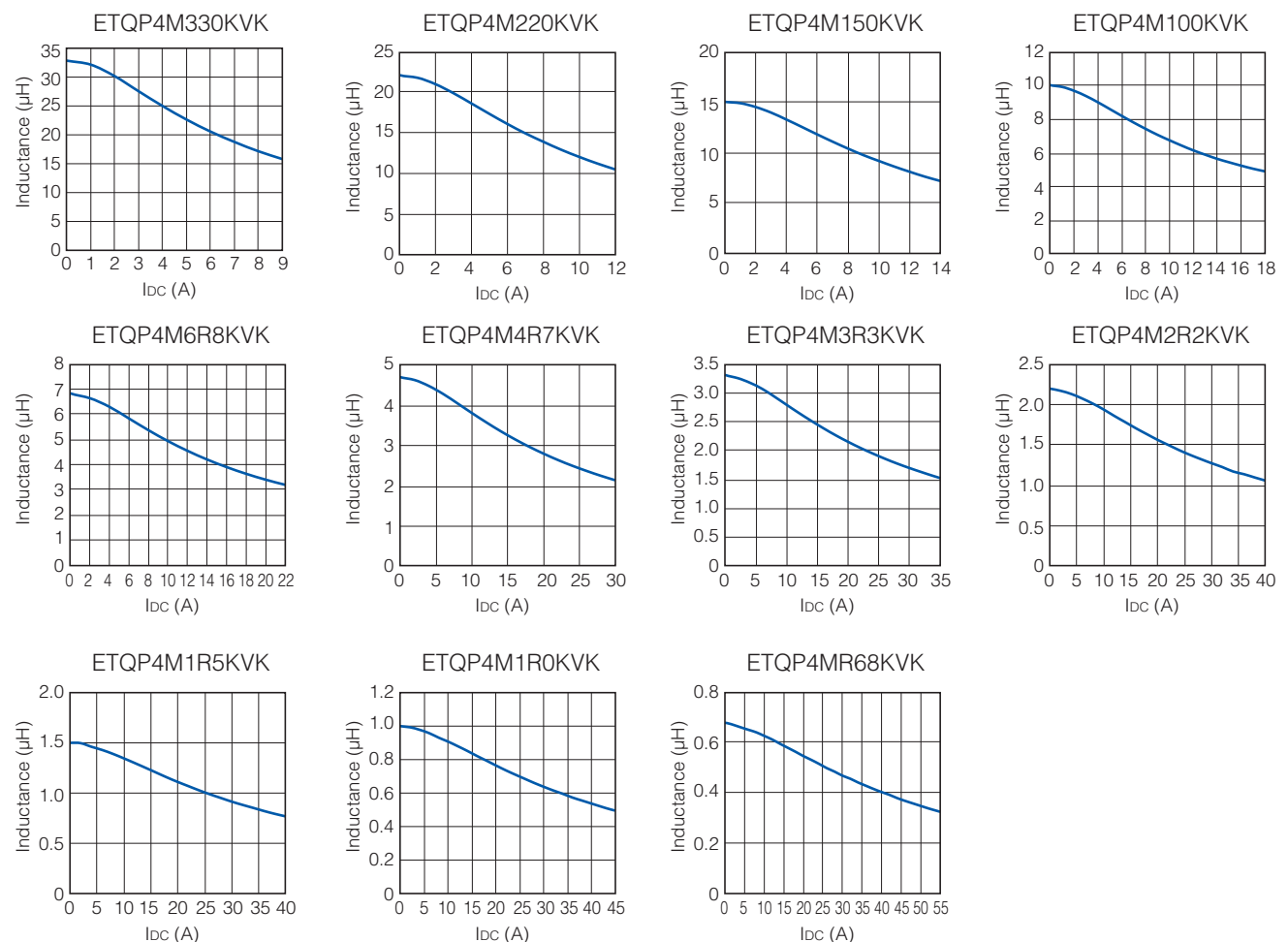

Performance Characteristics (Reference)

● Case Temperature vs DC Current

PWB condition A : Four-layer PWB (1.6 mm FR4), See also (*2)

PWB condition B : Multilayer PWB with high heat dissipation performance. See also (*3)

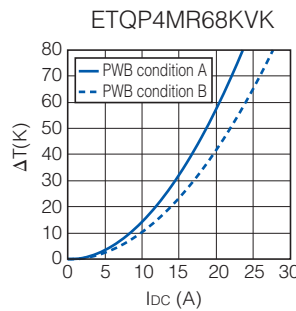
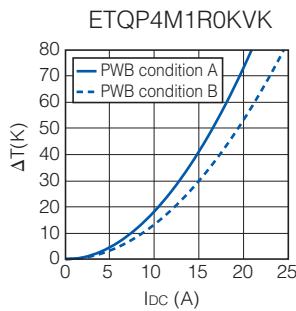
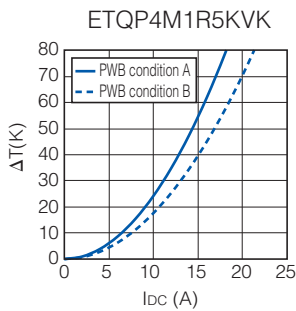
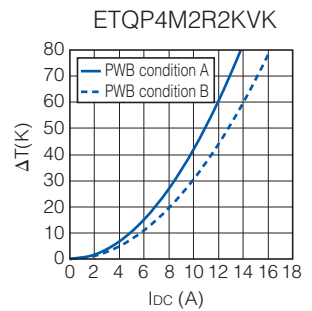
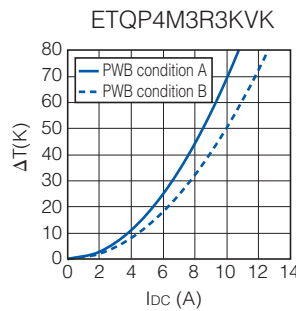
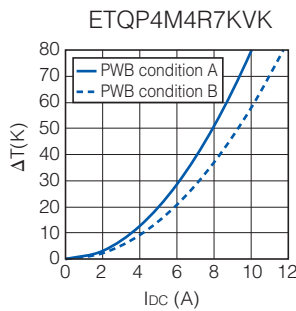
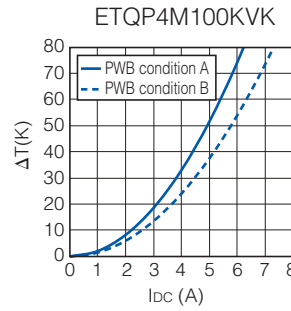
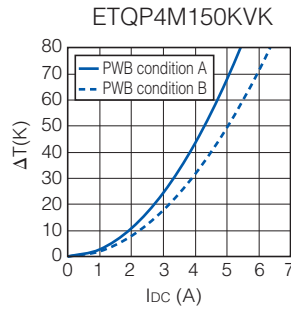
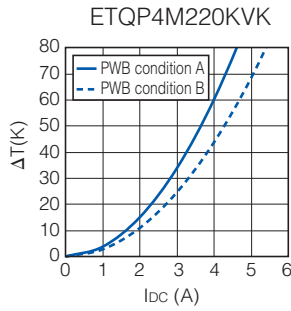

4. Series PCC-M1040M-LP (ETQP4M□□□KVC)

Standard Parts

Part No.	Inductance *1		DCR (at 20 °C) (mΩ)		Rated Current (Typ. : A)			Series
	L0 (μH)	Tolerance (%)	Typ. (max.)	Tolerance (%)	ΔT=40K		ΔL=-30%	
					(*2)	(*3)		
ETQP4M470KVC	47.00	±20	132.00 (145.20)	±10	2.8	3.4	4.7	PCC-M1040M-LP [10.7×10.0×4.0(mm)]
ETQP4M330KVC	33.00		84.60 (93.06)		3.4	4.2	5.6	
ETQP4M220KVC	22.00		60.00 (66.00)		4.1	5.0	7.4	
ETQP4M150KVC	15.00		37.00 (40.70)		5.2	6.3	9.2	
ETQP4M100KVC	10.00		25.40 (27.94)		6.3	7.6	10.8	
ETQP4M6R8KVC	6.80		18.50 (20.35)		7.4	8.9	12.1	
▲ETQP4M4R7KVC	4.70		11.80 (12.98)		9.2	11.2	13.9	
ETQP4M3R3KVC	3.30		9.40 (10.34)		10.3	12.6	17.1	
ETQP4M2R2KVC	2.20		6.80 (7.48)		12.1	14.8	21.0	
ETQP4M1R5KVC	1.50		4.90 (5.39)		14.3	17.4	25.0	
ETQP4M1R0KVC	1.00	2.60 (2.86)	19.6	23.9	34.6			

(*1) Measured at 100k Hz.

(*2) DC current which causes temperature rise of 40K. Parts are soldered by reflow on four-layer PWB (1.6 mm FR4) and measured at room temperature. See also (*5)

(*3) DC current which causes temperature rise of 40K. Parts are soldered by reflow on multilayer PWB with high heat dissipation performance. Note: Heat radiation constant are approx. 27 K/W measured on 10.7×10.0×4.0 mm case size. See also (*5)

(*4) Saturation rated current : DC current which causes L(0) drop -30 %.

(*5) Within a suitable application, the part's temperature depends on circuit design and certain heat dissipation conditions. This should be double checked in a worst case operation mode.

In normal case, the max.standard operating temperature of +155 °C should not be exceeded.

For higher operating temperature conditions, please contact Panasonic representative in your area.

▲ Under development (Start of mass production: the 2nd half of 2019) Please contact us for customized part no.

Performance Characteristics (Reference)

● Inductance vs DC Current

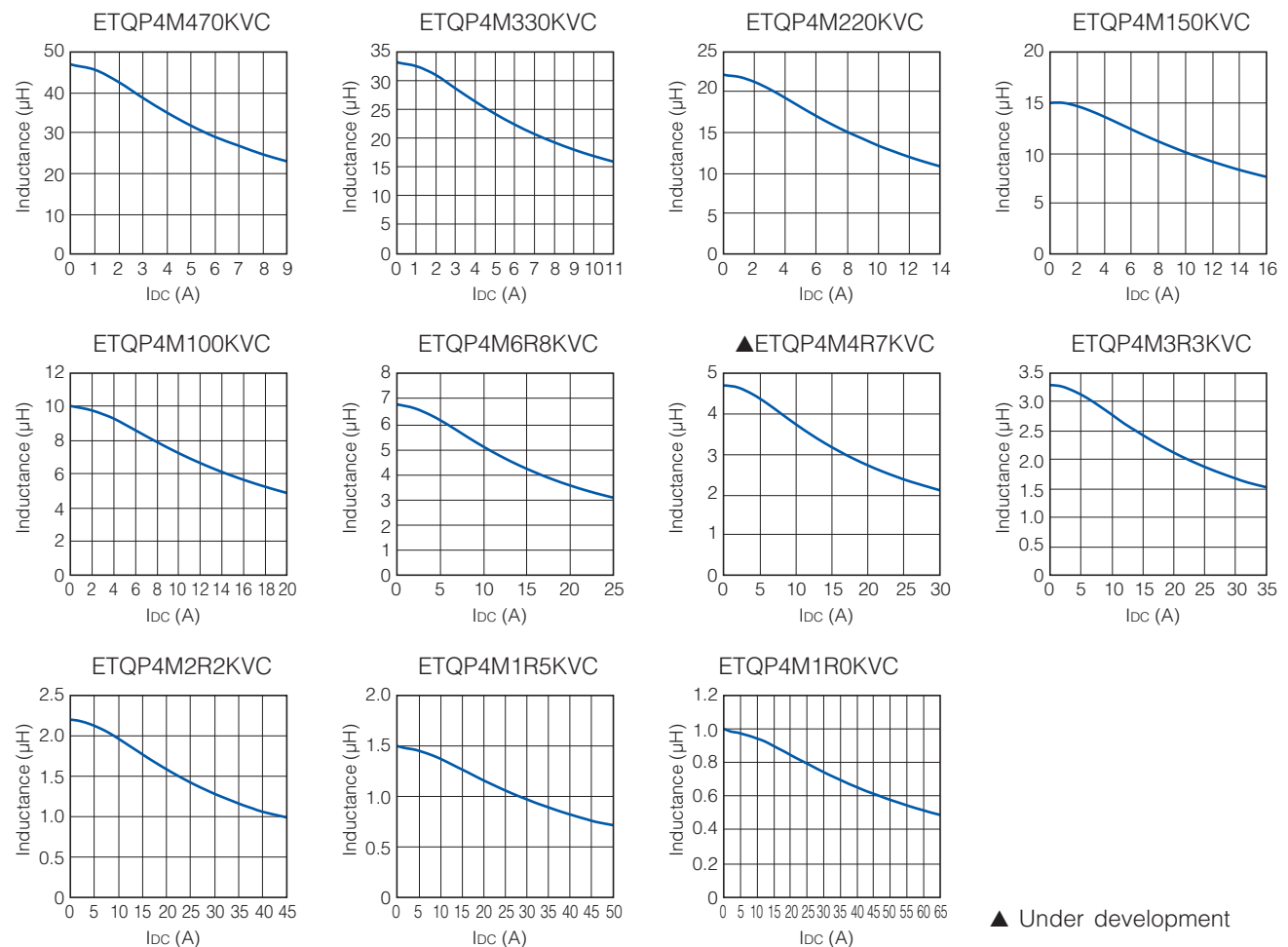

Performance Characteristics (Reference)

● Case Temperature vs DC Current

PWB condition A : Four-layer PWB (1.6 mm FR4), See also (*2)

PWB condition B : Multilayer PWB with high heat dissipation performance. See also (*3)

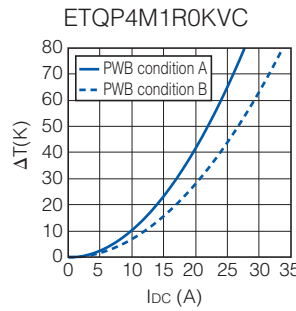
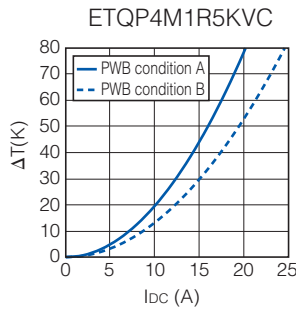
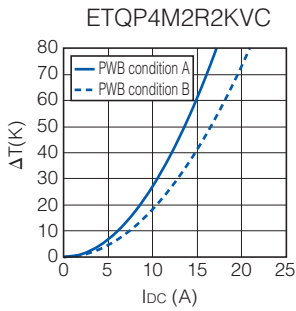
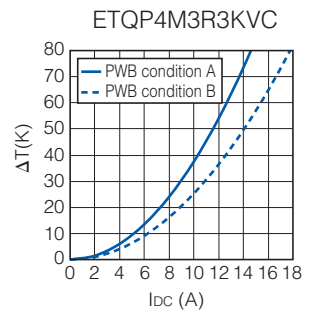
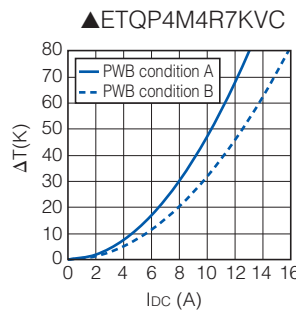
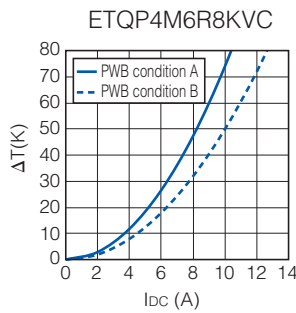
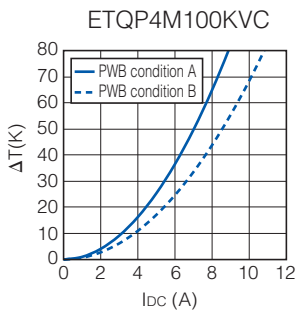
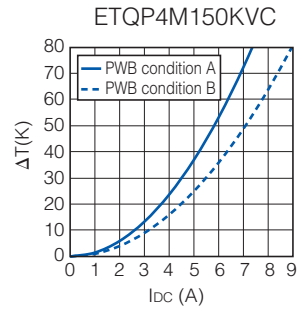
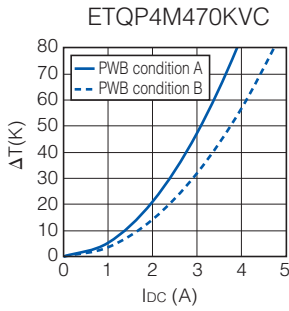

▲ Under development

Dimensions in mm (not to scale)

Dimensional tolerance unless noted : ± 0.5

Series PCC-M0530M-LP
(ETQP3M□□□KVP)

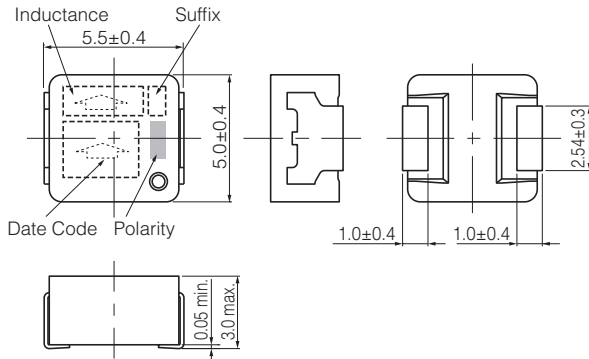

Series PCC-M0630M-LP
(ETQP3M□□□KVN)

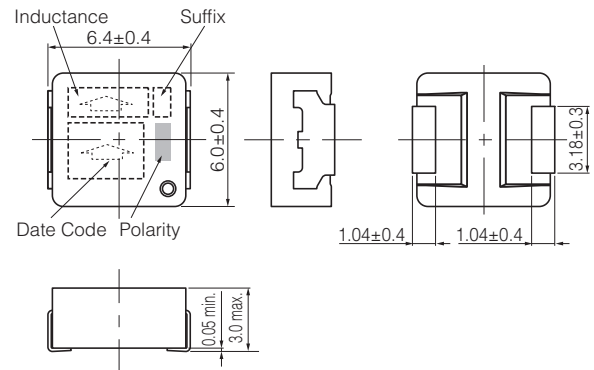

Series PCC-M0840M-LP
(ETQP4M□□□KVK)

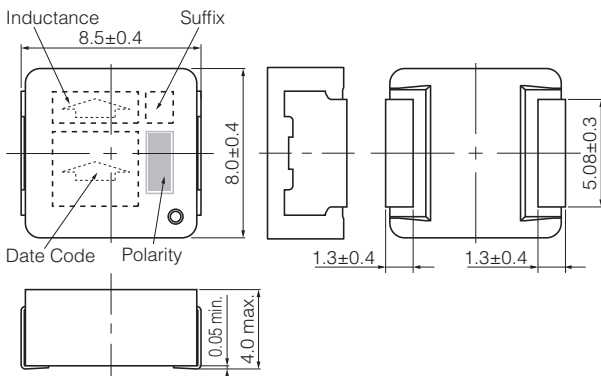

Series PCC-M1040M-LP
(ETQP4M□□□*KVC)
* Exemption "1R0"

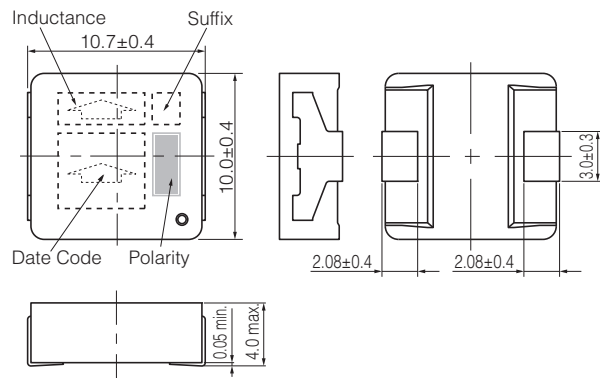

Series PCC-M1040M-LP
(ETQP4M1R0KVC)

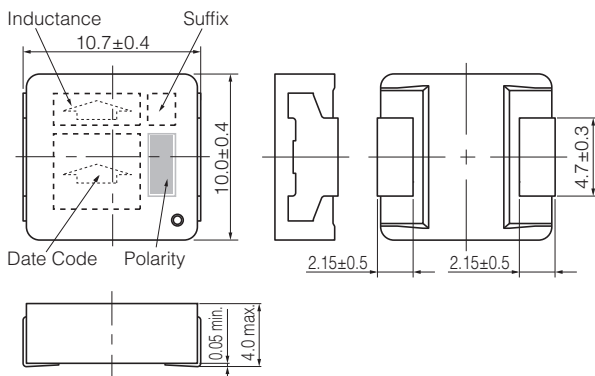

Recommended Land Pattern in mm (not to scale)

Dimensional tolerance unless noted : ± 0.5

Series PCC-M0530M-LP
(ETQP3M□□□KVP)



Don't wire on the pattern on shaded portion the PWB.

Series PCC-M0630M-LP
(ETQP3M□□□KVN)

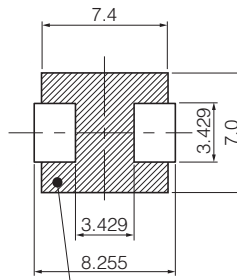

The same as the left.

Series PCC-M0840M-LP
(ETQP4M□□□KVK)

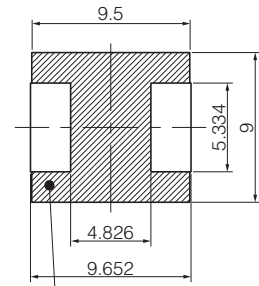

The same as the left.

Series PCC-M1040M-LP
(ETQP4M□□□*KVC)
* Exemption "1R0"

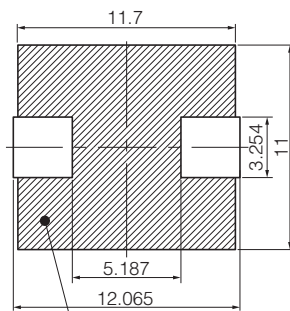

Don't wire on the pattern on shaded portion the PWB.

Series PCC-M1040M-LP
(ETQP4M1R0KVC)

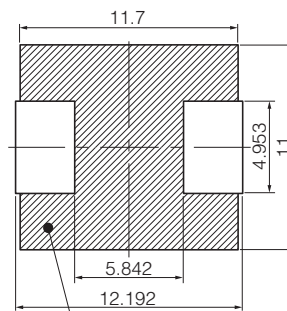

The same as the left.

■ As for Soldering Conditions and Safety Precautions (Power Choke Coils (Automotive Grade)),

Please see Data Files

Packaging Methods (Taping)

- Embossed Carrier Tape Dimensions in mm (not to scale)

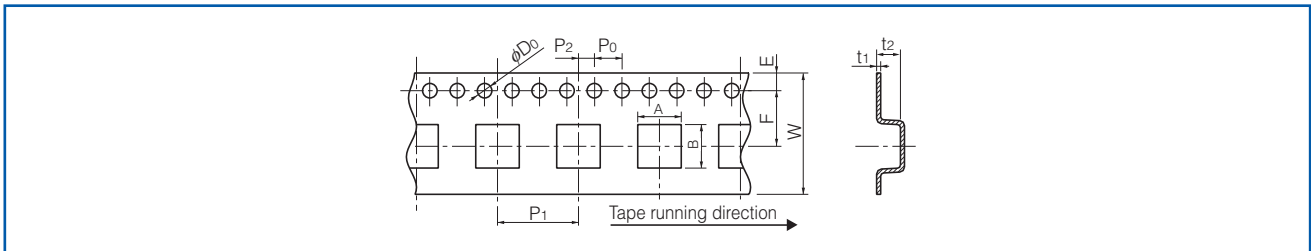

Series	A	B	W	E	F	P ₁	P ₂	P ₀	φD ₀	t ₁	t ₂
PCC-M0530M-LP	5.6	6.1	16	1.75	7.5	8	2	4	1.5	0.3	3.3
PCC-M0630M-LP	6.5	7.1	16	1.75	7.5	8	2	4	1.5	0.3	3.3
PCC-M0840M-LP	8.63	9.1	16	1.75	7.5	12	2	4	1.5	0.4	6.0
PCC-M1040M-LP	10.65	11.75	24	1.75	11.5	16	2	4	1.5	0.5	6.35

- Taping Reel Dimensions in mm (not to scale)

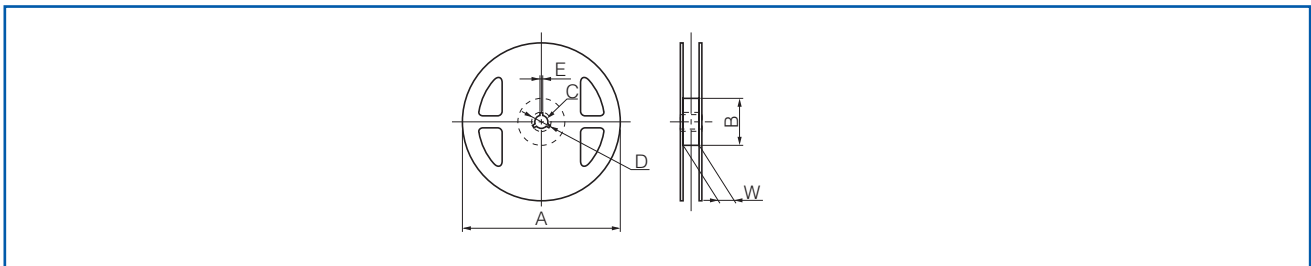

Series	A	B	C	D	E	W
PCC-M0530M-LP PCC-M0630M-LP PCC-M0840M-LP	330	(100)	13	21	2	17.5
PCC-M1040M-LP						25.5

Component Placement (Taping)

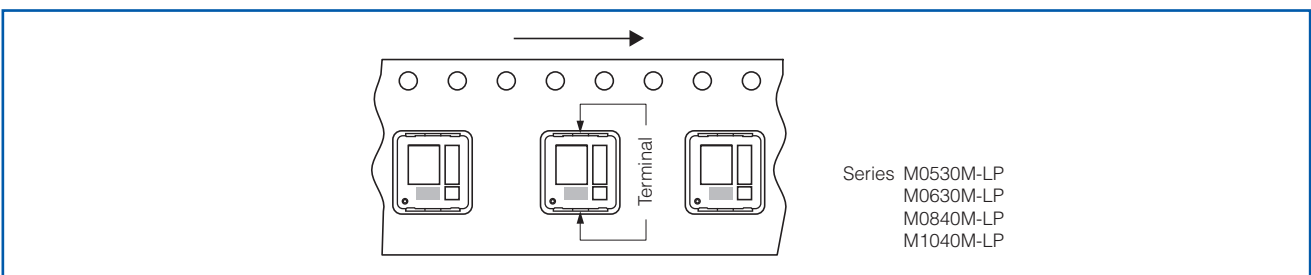

Standard Packing Quantity/Reel

Series	Part No.	Minimum Quantity / Packing Unit	Quantity per reel
PCC-M0530M-LP	ETQP3M□□□KVP	4,000 pcs / box (2 reel)	2,000 pcs
PCC-M0630M-LP	ETQP3M□□□KVN	4,000 pcs / box (2 reel)	2,000 pcs
PCC-M0840M-LP	ETQP4M□□□KVK	1,000 pcs / box (2 reel)	500 pcs
PCC-M1040M-LP	ETQP4M□□□KVC	1,000 pcs / box (2 reel)	500 pcs

Power Choke Coil (Automotive Grade)

Series: **PCC-M0648M-LE(MC)**
PCC-M0748M-LE(MC)



High heat resistance and high reliability
 Using metal composite core (MC)

Industrial Property : patents 3 (Registered 2/Pending 1)

Features

- Low loss (Low DC resistance)
- High heat resistance : Operation up to 150 °C including self-heating
- SMD type
- High-reliability : High vibration resistance as result of newly developed integral construction; under severe reliability conditions of automotive and other strenuous applications
- High bias current : Excellent inductance stability using ferrous alloy magnetic material
- Temp. stability : Excellent inductance stability over broad temp. range
- Low audible (buzz) noise : A gapless structure achieved with metal composite core
- High efficiency : Low DC resistance of winding and low eddy-current loss of the core
- Shielded construction
- AEC-Q200 Automotive qualified
- RoHS compliant

Recommended Applications

- Noise filter for various drive circuitry requiring high temp. operation and peak current handling capability
- Boost-Converter, Buck-Converter DC/DC

Standard Packing Quantity (Minimum Quantity/Packing Unit)

- 1,000 pcs./box (2 reel)

Explanation of Part Numbers

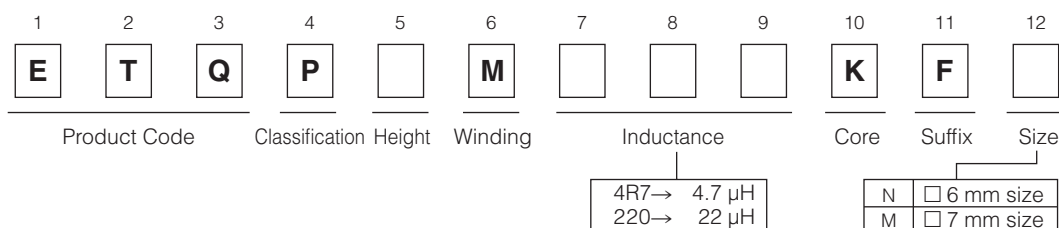

Temperature rating

Operating temperature range		Tc : -40 °C to +150 °C(Including self-temperature rise)
Storage condition	After PWB mounting	
	Before PWB mounting	Ta : -5 °C to +35 °C 85%RH max.

1. Series PCC-M0648M-LE (ETQP4M□□□KFN)

Standard Parts

Series	Part No.	Inductance *1		DCR (at 20 °C) (mΩ)		Rated Current (Typ. : A)		
		L0 (μH)	Tolerance (%)	Typ. (max.)	Tolerance (%)	ΔT=40K		ΔL=-30%
						(*2)	(*3)	
PCC-M0648M-LE [6.4×6.0×4.8(mm)]	ETQP4M3R3KFN	3.30	±20	13.10 (14.41)	±10	7.2	9.2	12.0
	ETQP4M4R7KFN	4.70		20.70 (22.77)		5.7	7.3	9.3
	ETQP4M100KFN	10.00		40.40 (44.44)		4.1	5.2	8.1
	ETQP4M150KFN	15.00		63.80 (70.18)		3.3	4.2	6.7

(*1) Measured at 100k Hz.

(*2) DC current which causes temperature rise of 40K. Parts are soldered by reflow on four-layer PWB (1.6 mm FR4) and measured at room temperature. See also (*5)

(*3) DC current which causes temperature rise of 40K. Parts are soldered by reflow on multilayer PWB with high heat dissipation performance. Note: Heat radiation constant are approx. 30 K/W measured on 6.4×6.0×4.8 mm case size. See also (*5)

(*4) Saturation rated current : DC current which causes L(0) drop -30 %.

(*5) Within a suitable application, the part's temperature depends on circuit design and certain heat dissipation conditions. This should be double checked in a worst case operation mode.

In normal case, the max.standard operating temperature of +150 °C should not be exceeded.

For higher operating temperature conditions, please contact Panasonic representative in your area.

Performance Characteristics (Reference)

● Inductance vs DC Current

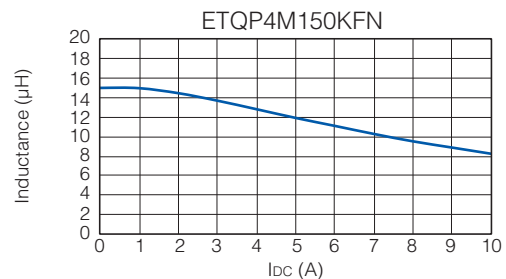
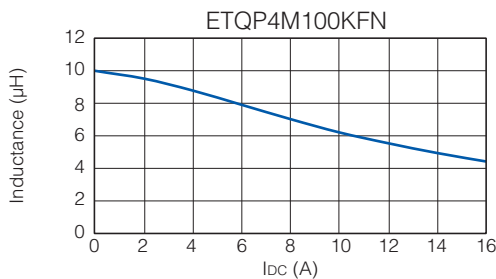
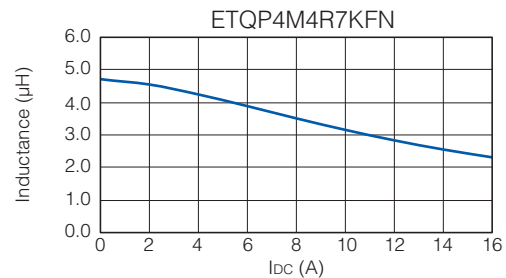
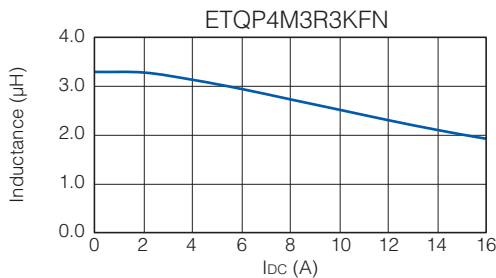

● Case Temperature vs DC Current

PWB condition A : Four-layer PWB (1.6 mm FR4), See also (*2)

PWB condition B : Multilayer PWB with high heat dissipation performance. See also (*3)

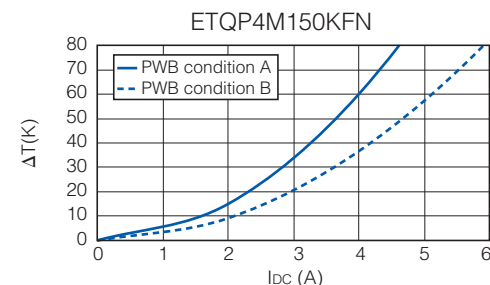
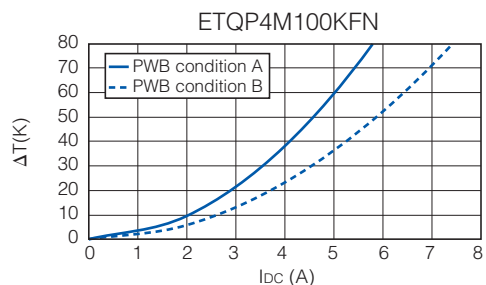
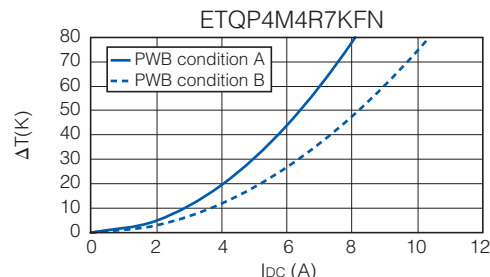
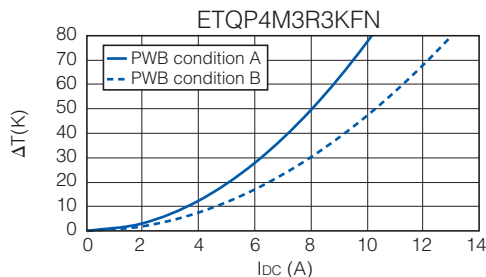

2. Series PCC-M0748M-LE (ETQP4M□□□KFM)

Standard Parts

Series	Part No.	Inductance *1		DCR (at 20 °C) (mΩ)		Rated Current (Typ. : A)		
		L0 (μH)	Tolerance (%)	Typ. (max.)	Tolerance (%)	ΔT=40K		ΔL=-30%
						(*2)	(*3)	
PCC-M0748M-LE [7.4×7.0×4.8(mm)]	ETQP4M4R7KFM	4.70	±20	16.80(18.48)	±10	6.5	8.8	10.7
	ETQP4M100KFM	10.00		36.00(39.60)		4.5	6.0	9.6
	ETQP4M220KFM	22.00		84.10(92.51)		2.9	3.9	4.6
	ETQP4M470KFM	47.00		148.60(163.46)		2.2	2.9	3.7

(*1) Measured at 100k Hz.

(*2) DC current which causes temperature rise of 40K. Parts are soldered by reflow on four-layer PWB (1.6 mm FR4) and measured at room temperature. See also (*5)

(*3) DC current which causes temperature rise of 40K. Parts are soldered by reflow on multilayer PWB with high heat dissipation performance. Note: Heat radiation constant are approx. 30 K/W measured on 7.4×7.0×4.8 mm case size. See also (*5)

(*4) Saturation rated current : DC current which causes L(0) drop -30 %.

(*5) Within a suitable application, the part's temperature depends on circuit design and certain heat dissipation conditions. This should be double checked in a worst case operation mode.

In normal case, the max.standard operating temperature of +150 °C should not be exceeded.

For higher operating temperature conditions, please contact Panasonic representative in your area.

Performance Characteristics (Reference)

● Inductance vs DC Current

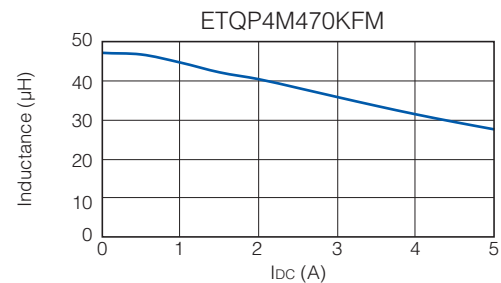
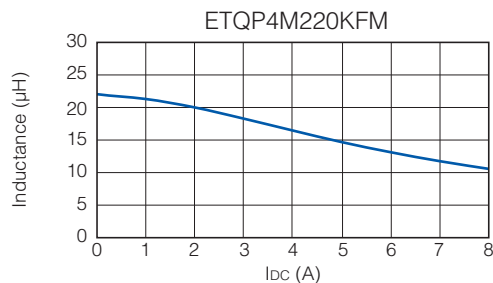
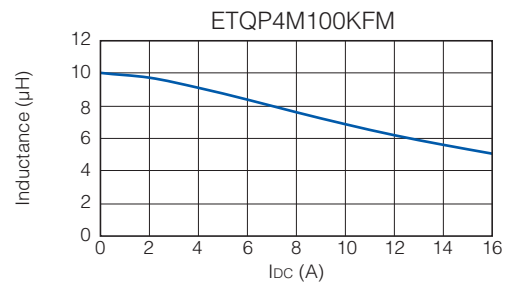
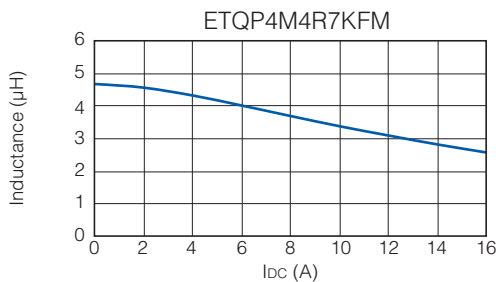

● Case Temperature vs DC Current

PWB condition A : Four-layer PWB (1.6 mm FR4), See also (*2)

PWB condition B : Multilayer PWB with high heat dissipation performance. See also (*3)

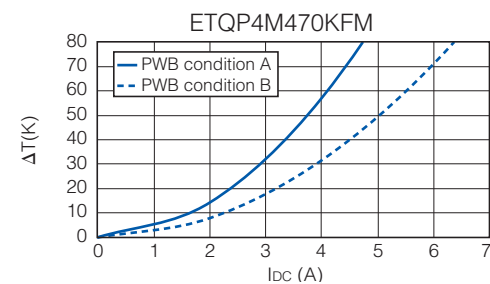
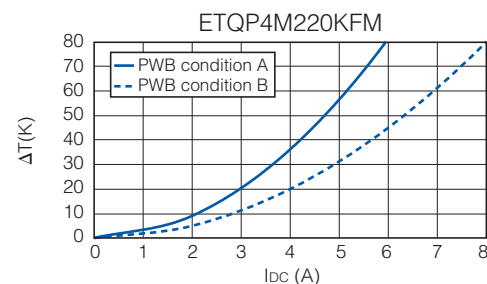
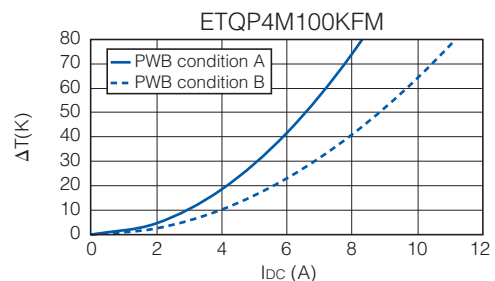
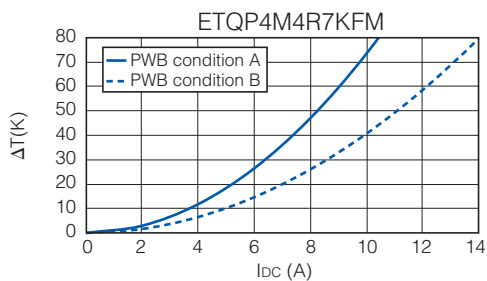

Dimensions in mm (not to scale)

Dimensional tolerance unless noted : ± 0.5

Series PCC-M0648M-LE
(ETQP4M□□□KFN)

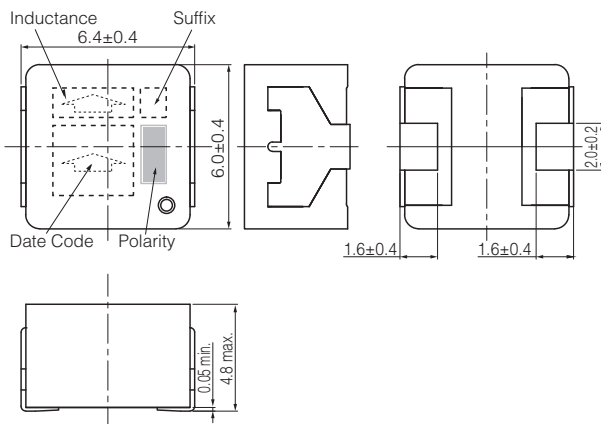

Series PCC-M0748M-LE
(ETQP4M□□□KFM)

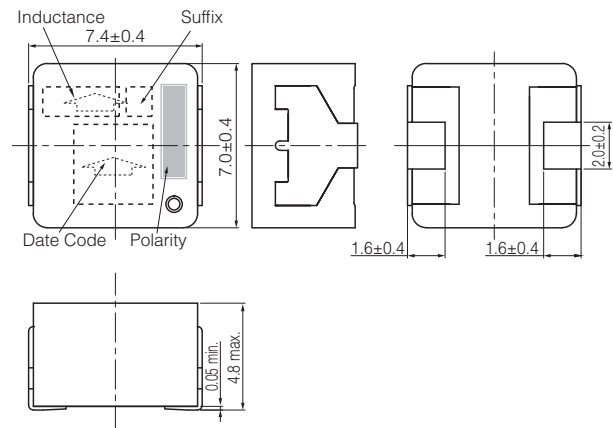

Recommended Land Pattern in mm (not to scale)

Dimensional tolerance unless noted : ± 0.5

Series PCC-M0648M-LE
(ETQP4M□□□KFN)

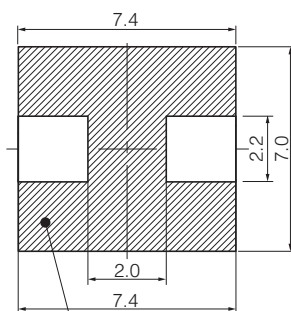

Don't wire on the pattern on shaded portion the PWB.

Series PCC-M0748M-LE
(ETQP4M□□□KFM)

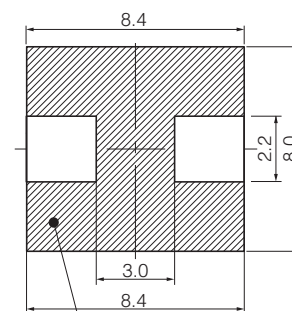

The same as the left.

As for Soldering Conditions and Safety Precautions (Power Choke Coils (Automotive Grade)),

Please see Data Files

Packaging Methods (Taping)

- Embossed Carrier Tape Dimensions in mm (not to scale)

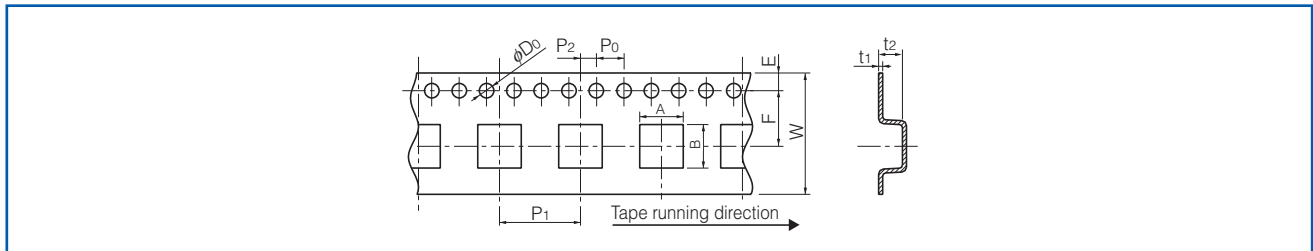

Series	A	B	W	E	F	P ₁	P ₂	P ₀	φD ₀	t ₁	t ₂
PCC-M0648M-LE	6.6	7.1	16	1.75	7.5	12	2	4	1.5	0.4	5.0
PCC-M0748M-LE	7.6	8.1	16	1.75	7.5	12	2	4	1.5	0.4	6.0

- Taping Reel Dimensions in mm (not to scale)

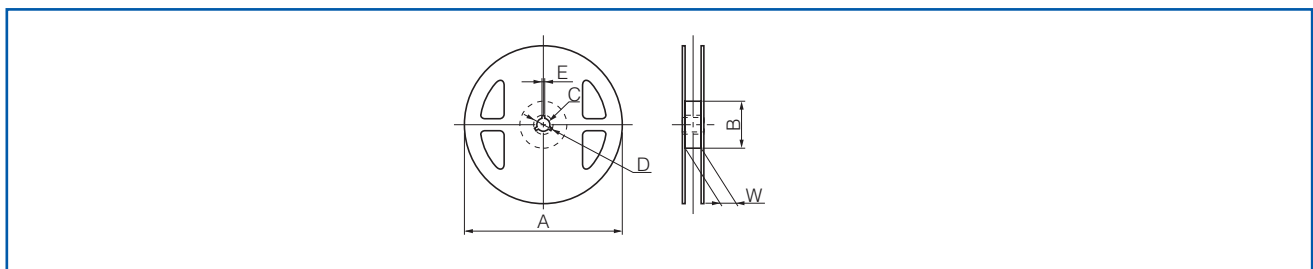

Series	A	B	C	D	E	W
PCC-M0648M-LE PCC-M0748M-LE	330	(100)	13	21	2	17.5

Component Placement (Taping)

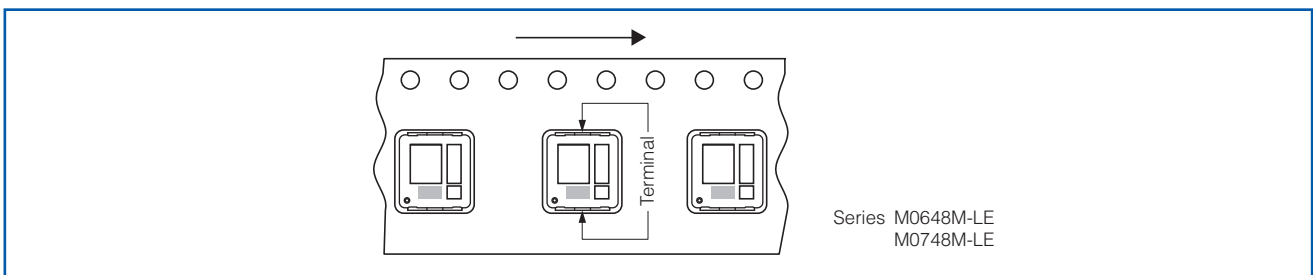

Standard Packing Quantity/Reel

Series	Part No.	Minimum Quantity / Packing Unit	Quantity per reel
PCC-M0648M-LE	ETQP4M□□□KFN	1,000 pcs. / box (2 reel)	500 pcs.
PCC-M0748M-LE	ETQP4M□□□KFM	1,000 pcs. / box (2 reel)	500 pcs.

Power Choke Coil (Automotive Grade)

Series: **PCC-M0530M-H(MC)**
PCC-M0630M-H(MC)



High heat resistance and high reliability
 Using metal composite core (MC)

Features

- Reduce core loss in high frequency band (More than 2 MHz)
- High heat resistance : Operation up to 150 °C including self-heating
- Low profile : 3 mm max. height
- SMD type
- High-reliability : High vibration resistance as result of newly developed integral construction; under severe reliability conditions of automotive and other strenuous applications
- High bias current : Excellent inductance stability using ferrous alloy magnetic material
- Temp. stability : Excellent inductance stability over broad temp. range
- Low audible (buzz) noise : New metal composite core technology
- High efficiency : Low R_{dc} of winding and low eddy-current loss of the core
- Shielded construction
- AEC-Q200 Automotive qualified
- RoHS compliant

Recommended Applications

- Noise filter for various drive circuitry requiring high temp. operation and peak current handling capability
- Boost-Converter, Buck-Converter DC/DC

Standard Packing Quantity (Minimum Quantity/Packing Unit)

- 2,000 pcs./box (2 reel)

Explanation of Part Numbers

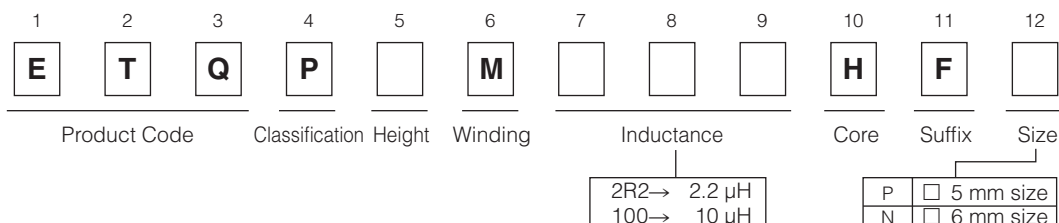

Temperature rating

Operating temperature range		Tc : -40 °C to +150 °C (Including self-temperature rise)
Storage condition	After PWB mounting	Ta : -5 °C to +35 °C 85%RH max.
	Before PWB mounting	

Standard Parts

Series	Part No.	Inductance *1		DCR (at 20 °C) (mΩ)		Rated Current (Typ. : A)		
		L0 (μH)	Tolerance (%)	Typ. (max.)	Tolerance (%)	ΔT=40K (*2)	ΔT=40K (*3)	ΔL=-30% (*4)
PCC-M0530M-H [5.5×5.0×3.0(mm)]	ETQP3M2R2HFP	2.2	±20	19.5 (21.45)	±20	5.2	6.3	9.0
PCC-M0630M-H [6.5×6.0×3.0(mm)]	ETQP3M100HFN	10.0		68.0 (74.8)		3.0	3.7	5.5
	ETQP3M220HFN	22.0		144.0 (158.4)		2.1	2.5	4.0

(*1) Measured at 100k Hz.

(*2) DC current which causes temperature rise of 40K. Parts are soldered by reflow on four-layer PWB (1.6 mm FR4) and measured at room temperature. See also (*5)

(*3) DC current which causes temperature rise of 40K. Parts are soldered by reflow on multilayer PWB with high heat dissipation performance. Note: Heat radiation constant are approx. 20 K/W measured. See also (*5)

(*4) Saturation rated current : DC current which causes L(0) drop -30 %.

(*5) Within a suitable application, the part's temperature depends on circuit design and certain heat dissipation conditions. This should be double checked in a worst case operation mode.

In normal case, the max.standard operating temperature of +150 °C should not be exceeded.

For higher operating temperature conditions, please contact Panasonic representative in your area.

Performance Characteristics (Reference)

● Inductance vs DC Current

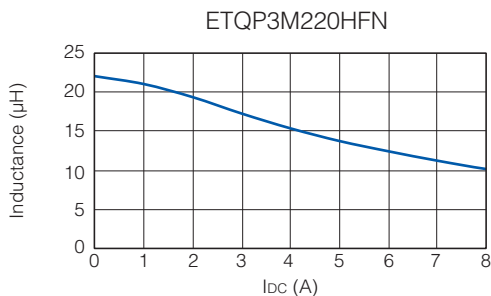
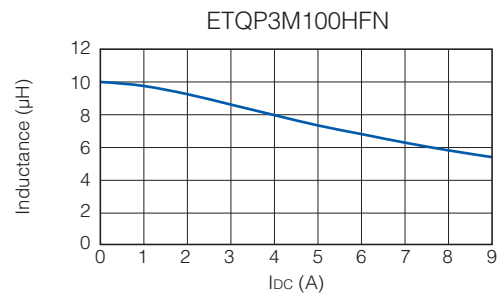
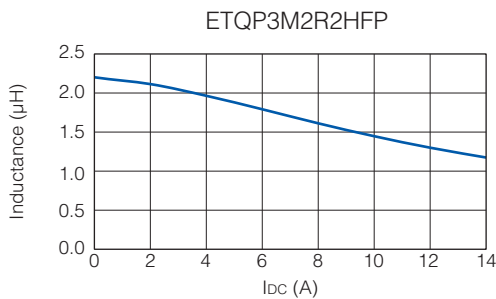

● Case Temperature vs DC Current

PWB condition A : Four-layer PWB (1.6 mm FR4), See also (*2)

PWB condition B : Multilayer PWB with high heat dissipation performance. See also (*3)

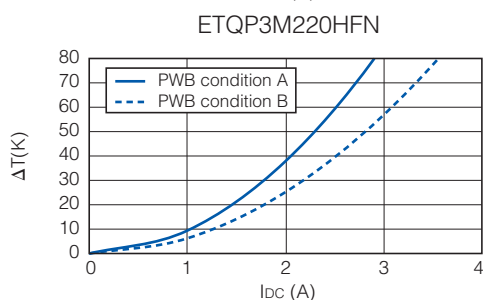
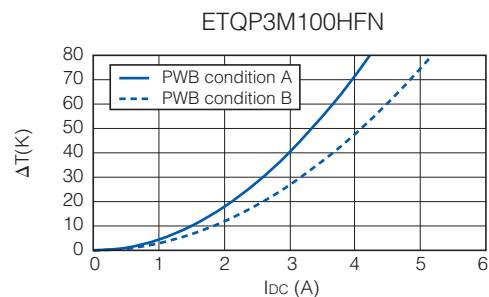
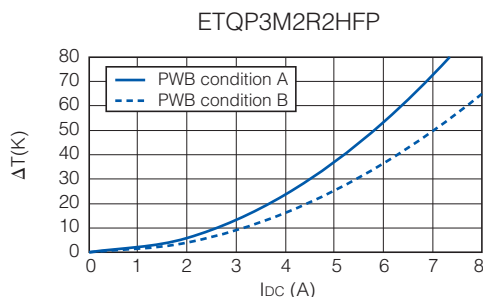

Dimensions in mm (not to scale)

Dimensional tolerance unless noted : ± 0.5

Series PCC-M0530M-H
(ETQP3M□□□HFP)

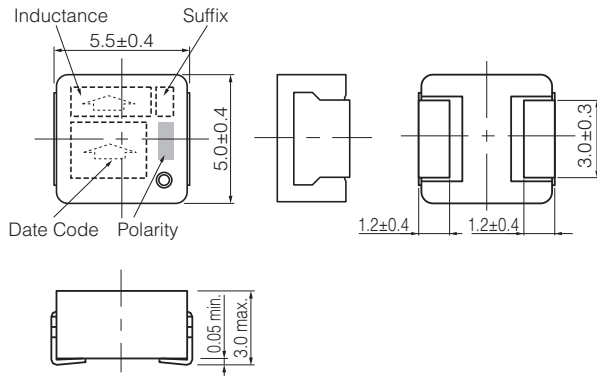

Series PCC-M0630M-H
(ETQP3M□□□HFN)

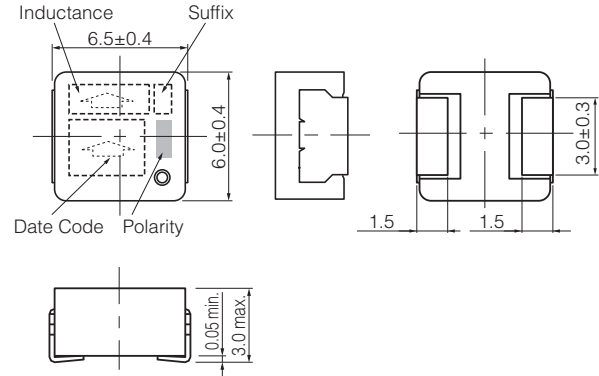

Recommended Land Pattern in mm (not to scale)

Dimensional tolerance unless noted : ± 0.5

Series PCC-M0530M-H
(ETQP3M□□□HFP)

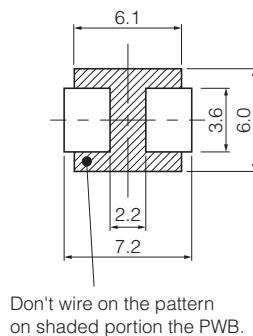

Series PCC-M0630M-H
(ETQP3M□□□HFN)

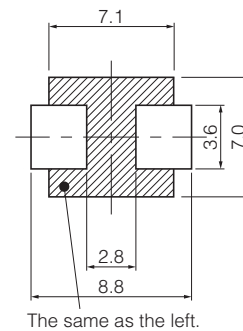

As for Soldering Conditions and Safety Precautions (Power Choke Coils (Automotive Grade)),

Please see Data Files

Packaging Methods (Taping)

- Embossed Carrier Tape Dimensions in mm (not to scale)

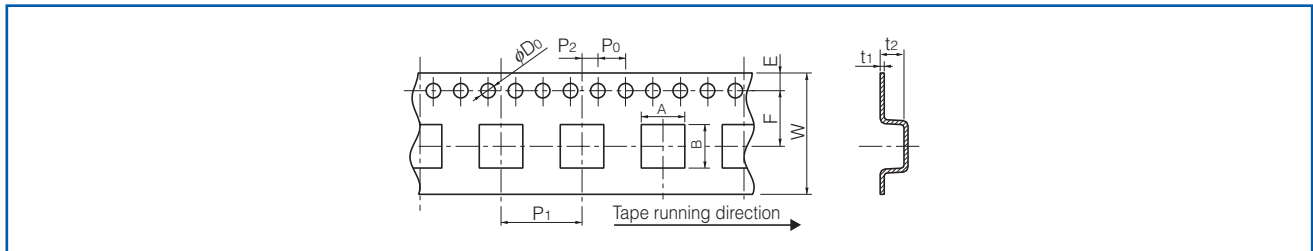

Series	A	B	W	E	F	P ₁	P ₂	P ₀	φD ₀	t ₁	t ₂
PCC-M0530M-H	5.6	6.1	16	1.75	7.5	12	2	4	1.5	0.4	3.3
PCC-M0630M-H	7.1	6.6	16	1.75	7.5	12	2	4	1.5	0.4	3.3

- Taping Reel Dimensions in mm (not to scale)

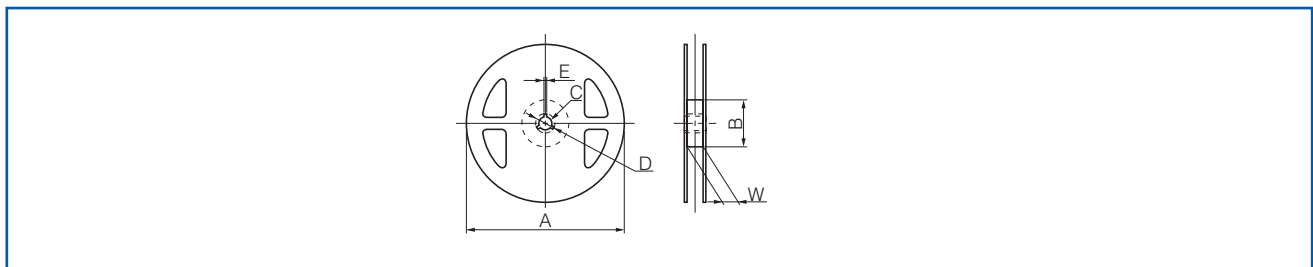

Series	A	B	C	D	E	W
PCC-M0530M-H PCC-M0630M-H	330	(100)	13	21	2	17.5

Component Placement (Taping)

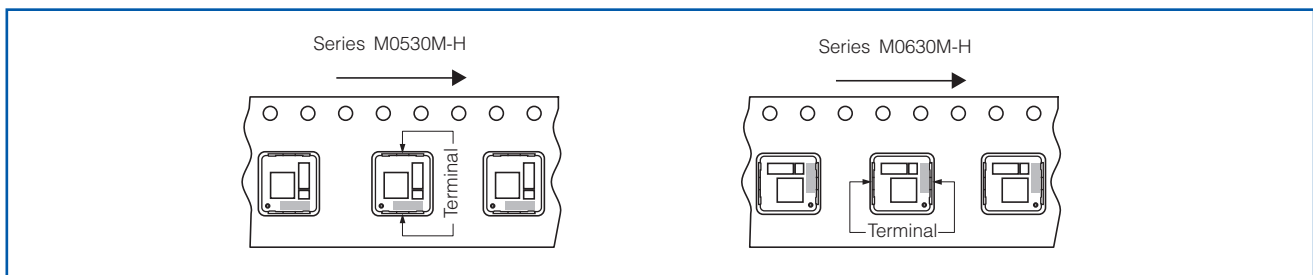

Standard Packing Quantity/Reel

Series	Part No.	Minimum Quantity / Packing Unit	Quantity per reel
PCC-M0530M-H	ETQP3M□□□HFP	2,000 pcs. / box (2 reel)	1,000 pcs.
PCC-M0630M-H	ETQP3M□□□HFN	2,000 pcs. / box (2 reel)	1,000 pcs.

Power Choke Coil (Automotive Grade)

Series : **PCC-D1413H (DUST)**

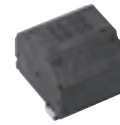

Realize high heat resistance, low loss and high reliability with dust core (DUST)

Industrial Property : patents 5 (Pending)

Features

- High heat resistance : Operation up to 150 °C
- SMD and small package : L×W×T=14.7×13.2×13.1 mm
- High-reliability : High vibration resistance due to newly developed integral construction and severe reliability condition of automotive application is covered
- High bias current : Excellent inductance stability by using ferrous alloy magnetic material
- High Vibration proof : 5 Hz to 2 kHz/30 G
- High efficiency : Achieve by Low loss Dust core and Edgewise coil with rectangular wire
- AEC-Q200 qualified
- RoHS compliant

Recommended Applications

- Driver circuits of fuel injection systems in automotive, driver circuits of diesel common rail injection, step-up power supplies for motor driver-circuits

Standard Packing Quantity

- 600 pcs./10 tray

Explanation of Part Numbers

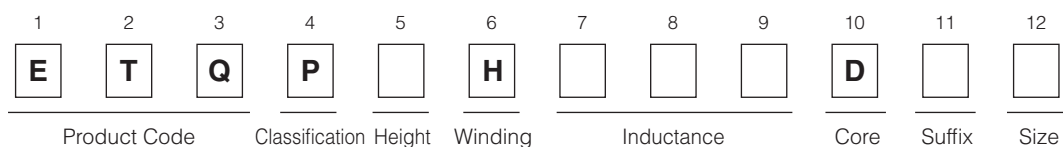

Temperature rating

Operating temperature range		Tc : -40 °C to +150 °C(Including self-temperature rise)
Storage condition	After PWB mounting	
	Before PWB mounting	Ta : -5 °C to +35 °C 85%RH max.

Standard Parts

Part No.	Inductance *1		DCR at 20 °C (mΩ)	ACR at 20 kHz (mΩ)	Rated Current *3 ΔT=40K (A)
	L0 at 0A (μH)	L1 at 10A (μH)			
ETQPDH240DTV	36.0±30%	(24.0) *2	25.8 typ.	50.0 typ.	6.9

(*1) Measured at 100 kHz.

(*2) Reference Only.

(*3) DC current which causes temperature rise of 40 K. Parts are soldered by reflow on four-layer PWB (1.6 mm FR4) and measured at room temperature.

* Within a suitable application, the part's temperature depends on circuit design and certain heat dissipation conditions. This should be double checked in a worst case operation mode.
In normal case, the max. standard operating temperature of +150 °C should not be exceeded.
For higher operating temperature conditions, please contact Panasonic representative in your area.

Performance Characteristics (Reference)

● Inductance vs DC Current

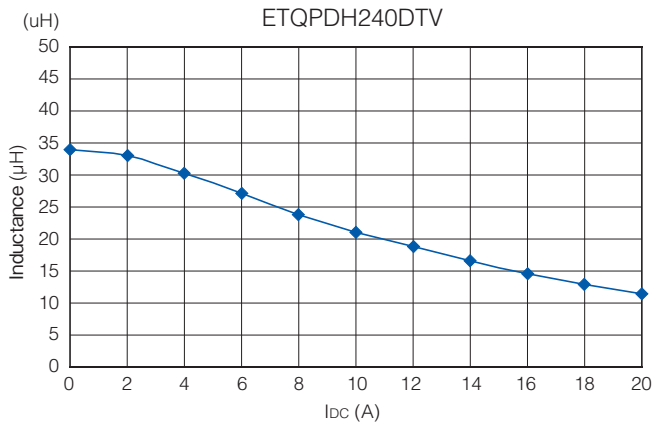

● Case Temperature vs DC Current

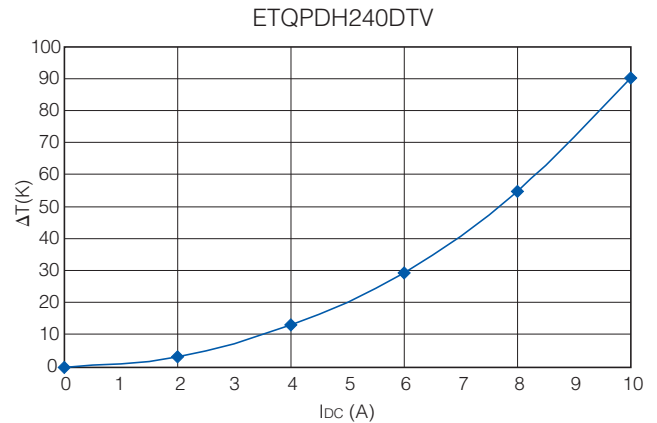

Dimensions in mm (not to scale)

Dimensional tolerance unless noted : ±0.5

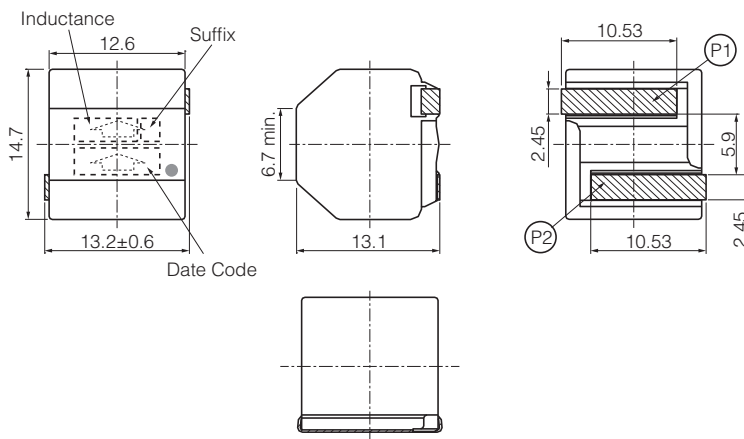

Connection

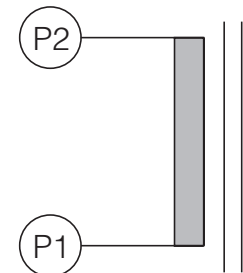

* None polar character

Recommended land patterns in mm (not to scale)

Dimensional tolerance unless noted : ±0.5

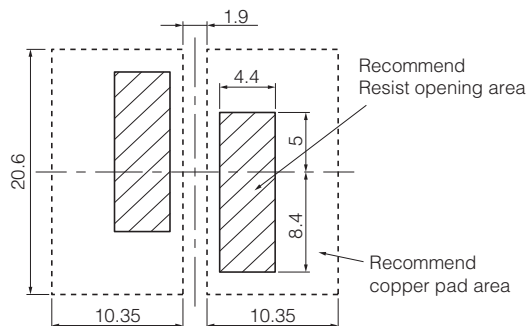

* Due to bigger part, Thermal Capacity is large and may occur PWB temperature differences during reflow process. Recommended land pattern (Heat absorb) should be designed with reflow mountability.

■ As for Soldering Conditions and Safety Precautions (Common precautions for Power Choke Coils (Automotive Grade)),

Please see Data Files

Packaging Methods (Tray)

- Blister Tray (mm) 60 pcs.

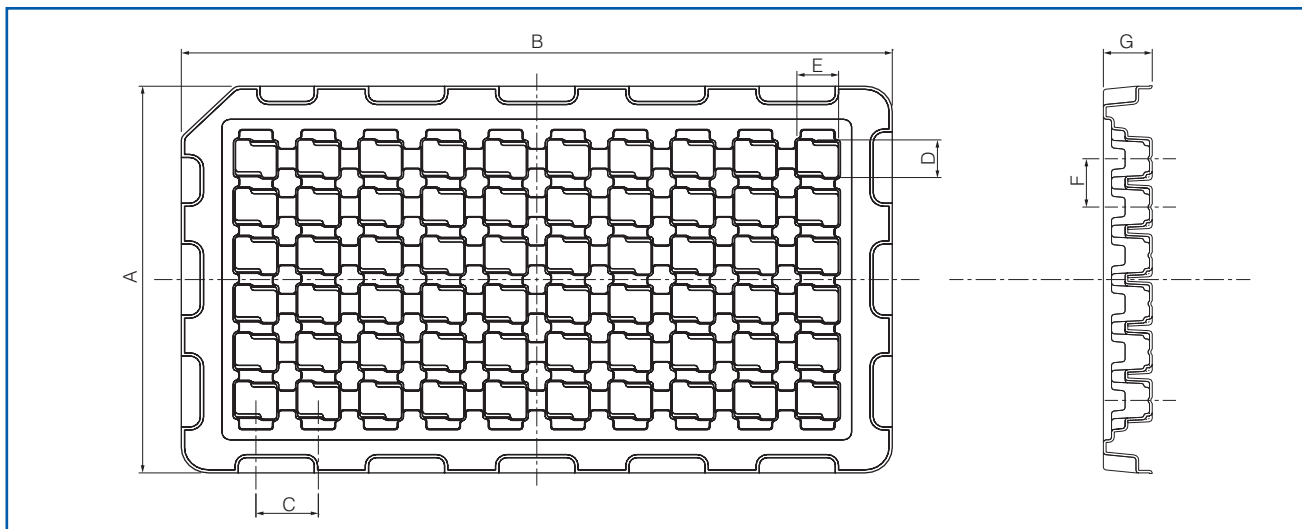

- Blister Tray Dimension

Part No.	A	B	C	D	E	F	G
ETQPDH240DTV	152	262	23	14.8	15.1	19	18

Component Placement (Tray)

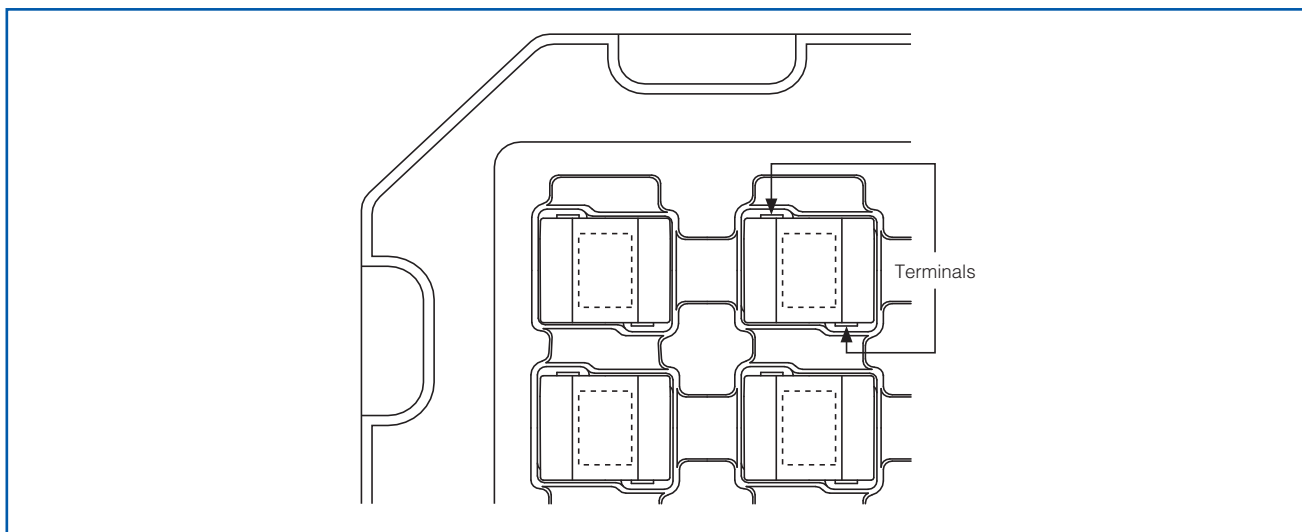

Standard Packing Quantity/Tray

Part No.	Quantity
ETQPDH240DTV	600 pcs. /10 tray (60 pcs. /1 tray)

Soldering Conditions

Reflow soldering conditions

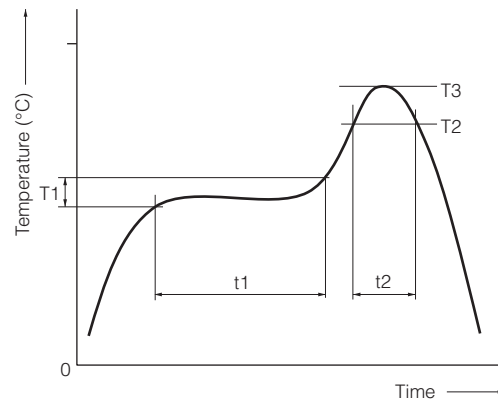

- Pb free solder recommended temperature profile
Power Choke Coils (Automotive Grade)

Part No.	Preheat		Soldering		Peak Temperature		Time of Reflow
	T1 [°C]	t1 [s]	T2 [°C]	t2 [s]	T3	T3 Limit	
ETQP3M□□□YFP	150 to 170	60 to 120	230 °C	30 to 40	250 °C, 5 s	260 °C, 10 s	2 times max.
ETQP4M□□□YFP							
ETQP3M□□□YFN							
ETQP4M□□□YFN							
ETQP5M□□□YFM							
ETQP5M□□□YGM							
ETQP5M□□□YFK							
ETQP5M□□□YGK							
ETQP5M□□□YFC							
ETQP5M□□□YGC							
ETQP5M□□□YLC							
ETQP6M□□□YLC							
ETQP5M□□□YSK							
ETQP5M□□□YSC							
ETQP8M□□□JFA							
ETQP3M□□□KVP							
ETQP3M□□□KVN							
ETQP4M□□□KVK							
ETQP4M□□□KVC							
ETQP4M□□□KFN							
ETQP4M□□□KFM							
ETQP3M□□□HFP							
ETQP3M□□□HFN							
ETQPDH□□□DTV							

⚠ Safety Precautions

(Common precautions for Power Choke Coils (Automotive Grade) : Series DUST, Series MC)

- When using our products, no matter what sort of equipment they might be used for, be sure to make a written agreement on the specifications with us in advance. The design and specifications in this catalog are subject to change without prior notice.
- Do not use the products beyond the specifications described in this catalog.
- This catalog explains the quality and performance of the products as individual components. Before use, check and evaluate their operations when installed in your products.
- Install the following systems for a failsafe design to ensure safety if these products are to be used in equipment where a defect in these products may cause the loss of human life or other significant damage, such as damage to vehicles (automobile, train, vessel), traffic lights, medical equipment, aerospace equipment, electric heating appliances, combustion/gas equipment, rotating equipment, and disaster/crime prevention equipment.
- * Systems equipped with a protection circuit and a protection device
- * Systems equipped with a redundant circuit or other system to prevent an unsafe status in the event of a single fault

⚠ Precautions for use

1. Provision to abnormal condition

This power choke coil itself does not have any protective function in abnormal condition such as overload, short-circuit and open-circuit conditions, etc.

Therefore, it shall be confirmed as the end product that there is no risk of smoking, fire, dielectric withstand voltage, insulation resistance, etc. in abnormal conditions to provide protective devices and/or protection circuit in the end product.

2. Temperature rise

Temperature rise of power choke coil depends on the installation condition in end products. It shall be confirmed in the actual end product that temperature rise of power choke coil is in the limit of specified temperature class.

3. Dielectric strength

Dielectric withstanding test with higher voltage than specific value will damage Insulating material and shorten its life.

4. Water

This Power choke coil must not be used in wet condition by water, coffee or any liquid because insulation strength becomes very low in such condition.

5. Potting

If this power choke coil is potted in some compound, coating material of magnet wire might be occasionally damaged. Please ask us if you intend to pot this power choke coil.

6. Model

When this power choke coil is used in a similar or new product to the original one, it might be unable to satisfy the specifications due to difference of condition of usage.

Please ask us if you use this power choke coil in the manner such as above.

7. Drop

If the power choke coil receives mechanical stress such as drop, characteristics may become poor (due to damage on coil bobbin, etc.). Never use such stressed power choke coil.

8. Printed circuit board design

- ① Land pattern and Via which exceed Operating Voltage, should not be placed top layer PWB under the products for keeping isolation between inside coil and surface of PWB. **(Series DUST)**
- ② To the opposing part in this power choke coil bottom please install neither pattern nor the beer, etc. **(Series MC)**

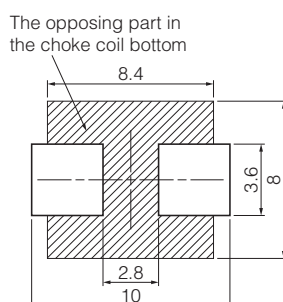

- ③ Parts arranged around this power choke coil do not touch the surface of this power choke coil (Top side and side).
(Series MC)

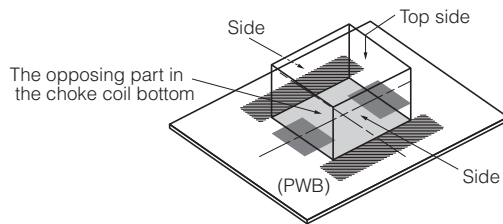

- ④ This power choke coil is different from the ferrite core-type that installs general concentration GAP. It has the leakage magnetic bunch distribution of the choke coil to the vertical direction. Please be cautious when using parts and circuit compositions which are easily affected by the leakage flux.

9. Solvent (Series MC)

If this power choke coil is dipped in the cleaning agent, and the coating agent of the toluene and the xylene system, there is a possibility that the performance decreases greatly. Please ask us if you intend to pot this power choke coil.

10. Static electricity measures (Series MC)

① Circuit design

Please set up the ESD measures parts such as capacitors in the former steps of this power choke coil for static electricity when there is a possibility that static electricity is impressed to the choke coil on the circuit.

Moreover, please consult our company about such a case once.

② Treatment with single

Take countermeasures against static electricity when using single power choke coil. (process and equipment)

There is a possibility that the characteristic changes when the voltage of 200 V or more is impressed to this power choke coil. Please handle 200 V or less.

11. Other using environment

This power choke coil is not designed for the use in the following, special environment.

Therefore, please do not use it in the following special environment.

- Use in place where a lot of causticity gases such as sea breeze, Cl₂, H₂S, NH₃, SO₂, and No_x exist.
- Use in place where out-of-door exposure and direct sunshine strike.

12. Keeping environment

If this power choke coil is kept under following environment and condition, there is a possibility that the performance and soldering decreases greatly.

- Keep in place where a lot of causticity gases such as sea breeze, Cl₂, H₂S, NH₃, SO₂, and No_x exist.
- Keep in place where out-of-door exposure and direct sunshine strike.

<Package markings>

Package markings include the product number, quantity, and country of origin.

In principle, the country of origin should be indicated in English.

Power Choke Coil

Series : **PCC-M0730L (MC)**

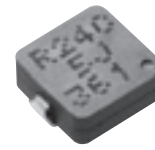

Small mounting size
for multi-phase DC/DC converter circuits

Features

- Small type (8.7×7.0×H3.0 mm)
- High power (22 A)
- Low loss (R_{DC} :1.12 m Ω)
- Tighter DCR tolerance (± 7 %)
- Suitable for high frequency circuit (up to 1 MHz)
- Low buzz noise due to its gap-less structure
- RoHS compliant

Recommended Applications

- Notebook PC power supply modules
- Servers, Routers, DC/DC converters for driving CPUs

Standard Packing Quantity (Minimum Quantity/Packing Unit)

- 3,000 pcs./box (2 reel)

Explanation of Part Numbers

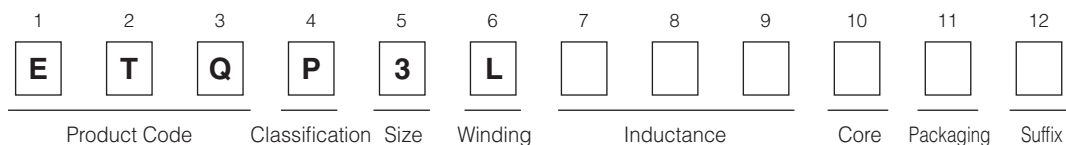

Standard Parts

Part No.	Inductance (at 20 °C)*1			Rated current (A)*2	Rated current (ref) (A)*3	DC resistance (at 20 °C) (m Ω)
	L0 at 0A	L1 *4				
	(μ H)	(μ H)	Measurement current (A)			
ETQP3LR24CFM	0.24 \pm 20 %	(0.19)	22	22	35	1.12 \pm 7 %

(*1) Inductance is measured at 1.0 MHz.

(*2) Rated current defines actual value of DC current, when temperature rise of coil becomes 40 K. (Method A)

(*3) Rated current defines actual value of DC current, when temperature rise of coil becomes 40 K. (Method B)

(*4) Reference only

(*5) Method A (PANASONIC's standard measurement conditions),

Method B (high heat dissipation measurement) is different from Method A by the measurement methods.

In normal application condition, the part's temperature depends on circuit design and heat dissipation condition. This condition shall be verified by the worst operational condition.

Performance Characteristics (Reference)

Inductance vs DC Current

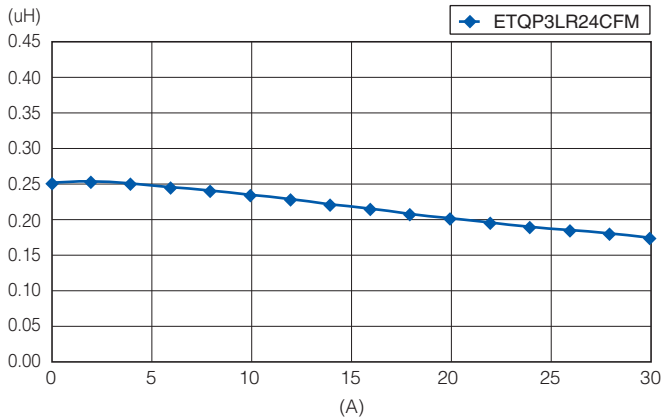

Case Temperature vs DC Current (Method A)

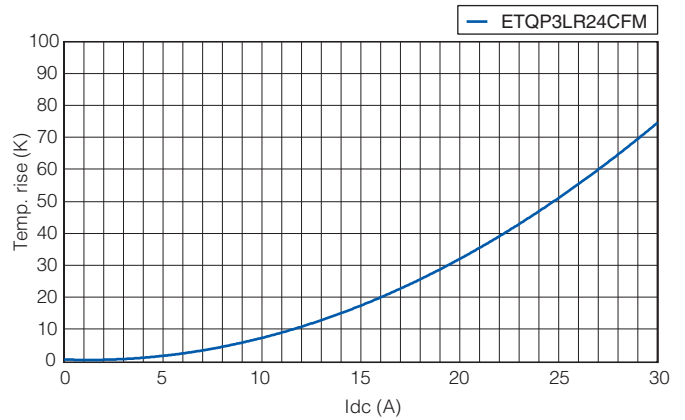

Dimensions in mm (not to scale)

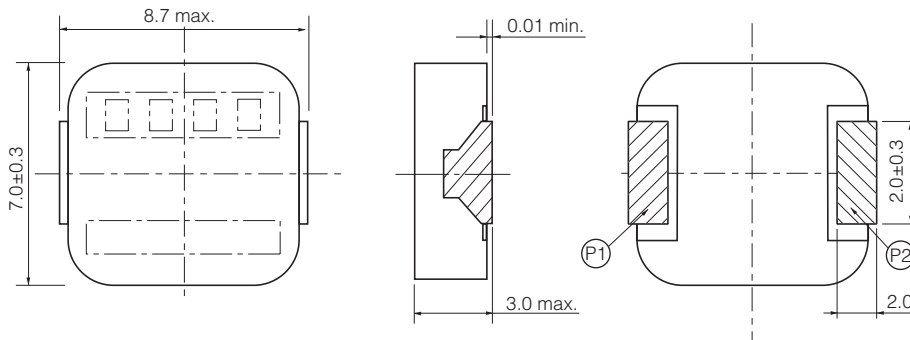

Connection

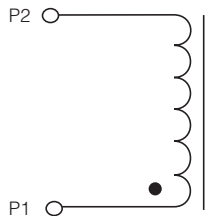

Recommended land patterns in mm (not to scale)

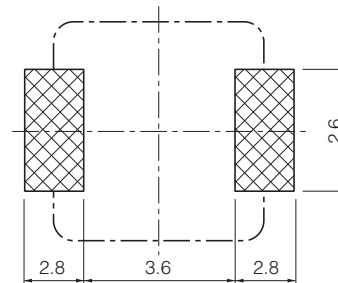

As for Packaging Methods, Soldering Conditions and Safety Precautions (Power Choke Coils for Consumer use),

Please see Data Files

Power Choke Coil

Series : **PCC-M0740L (MC)**
Low DCR Type



Small mounting size
 for multi-phase DC/DC converter circuits

Features

- Small type (8.7×7.0×H4.0 mm)
- High power (17 A to 24 A)
- Low loss (R_{DC} :1.0 to 1.5 mΩ)
- Tighter DCR tolerance ($\pm 7\%$)
- Suitable for high frequency circuit (up to 1 MHz)
- Low buzz noise due to its gap-less structure
- RoHS compliant

Recommended Applications

- Notebook PC power supply modules
- Servers, Routers, DC/DC converters for driving CPUs

Standard Packing Quantity (Minimum Quantity/Packing Unit)

- 3,000 pcs./box (2 reel)

Explanation of Part Numbers

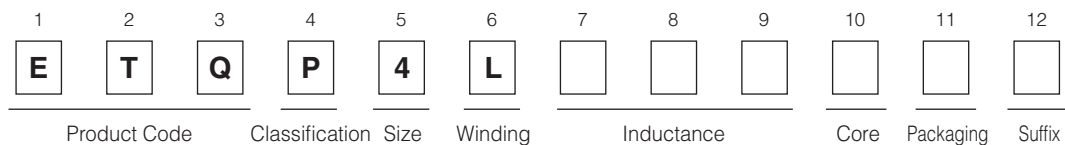

Standard Parts

Part No.	Inductance (at 20 °C)*1			Rated current (A)*2	Rated current (ref) (A)*3	DC resistance (at 20 °C) (mΩ)
	L0 at 0A	L1 *4				
	(μH)	(μH)	Measurement current (A)			
ETQP4LR24AFM	0.24±20 %	(0.20)	24	24	35.5	1.00±7 %
ETQP4LR36AFM	0.36±20 %	(0.30)	20	20	31.0	1.35±7 %
ETQP4LR42AFM	0.42±20 %	(0.35)	17	17	28.5	1.50±7 %

(*1) Inductance is measured at 1.0 MHz.

(*2) Rated current defines actual value of DC current, when temperature rise of coil becomes 40 K. (Method A)

(*3) Rated current defines actual value of DC current, when temperature rise of coil becomes 40 K. (Method B)

(*4) Reference only

(*5) Method A (PANASONIC's standard measurement conditions),

Method B (high heat dissipation measurement) is different from Method A by the measurement methods.

In normal application condition, the part's temperature depends on circuit design and heat dissipation condition. This condition shall be verified by the worst operational condition.

Performance Characteristics (Reference)

Inductance vs DC Current

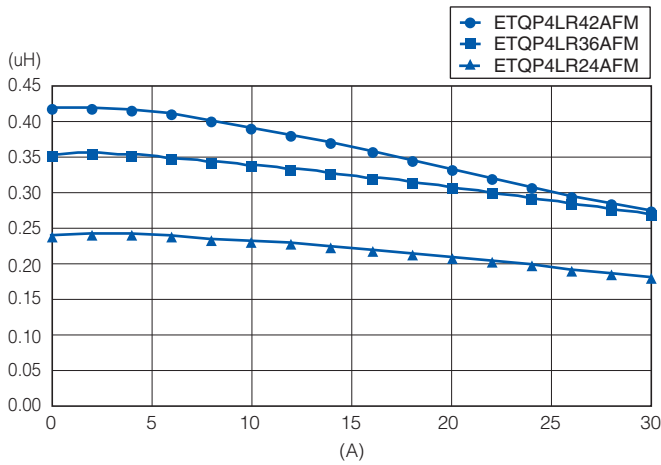

Case Temperature vs DC Current (Method A)

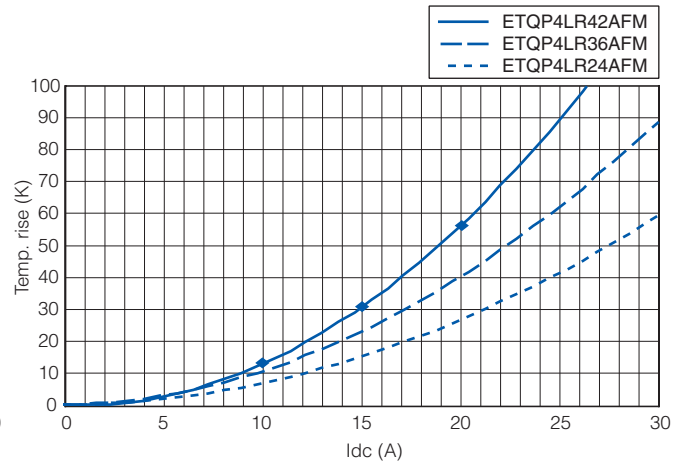

Dimensions in mm (not to scale)

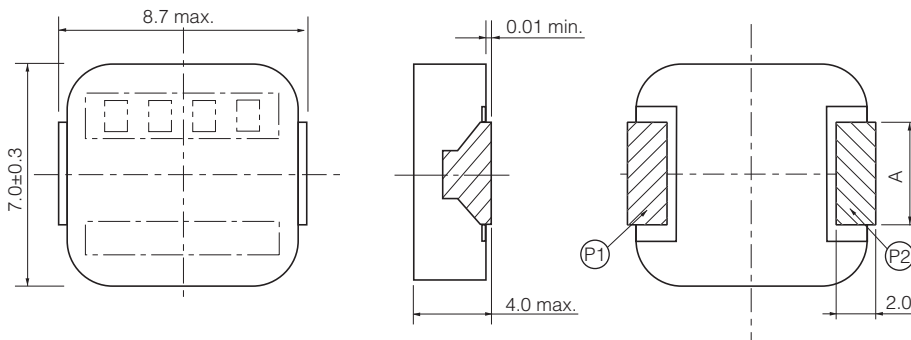

Part No.	A
ETQP4LR24AFM	3.0±0.3
ETQP4LR36AFM	2.0±0.3
ETQP4LR42AFM	

Connection

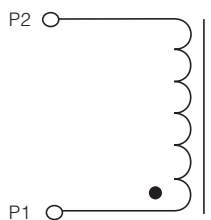

Recommended land patterns in mm (not to scale)

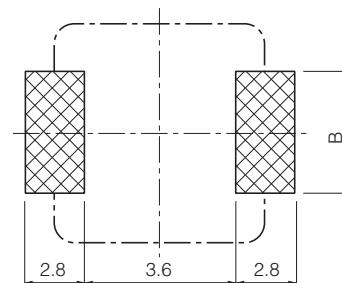

Part No.	B
ETQP4LR24AFM	3.6
ETQP4LR36AFM	2.6
ETQP4LR42AFM	

As for Packaging Methods, Soldering Conditions and Safety Precautions (Power Choke Coils for Consumer use),

Please see Data Files

Power Choke Coil

Series : **PCC-M1040L (MC)**



Small mounting size
for multi-phase DC/DC converter circuits

Features

- Small type (11.5×10.0×H4.0 mm)
- High power (21 A to 28 A)
- Low loss (R_{DC} :0.7 to 1.56 mΩ)
- Tighter DCR tolerance ($\pm 5\%$ to $\pm 10\%$)
- Suitable for high frequency circuit (up to 1 MHz)
- Low buzz noise due to its gap-less structure
- RoHS compliant

Recommended Applications

- Servers, Routers, DC/DC converters for driving CPUs
- Notebook PC power supply modules

Standard Packing Quantity (Minimum Quantity/Packing Unit)

- 2,000 pcs./box (2 reel) : ETQP4LR36WFC, ETQP4LR56WFC, ETQP4LR45XFC
- 1,000 pcs./box (2 reel) : ETQP4LR19WFC

Explanation of Part Numbers

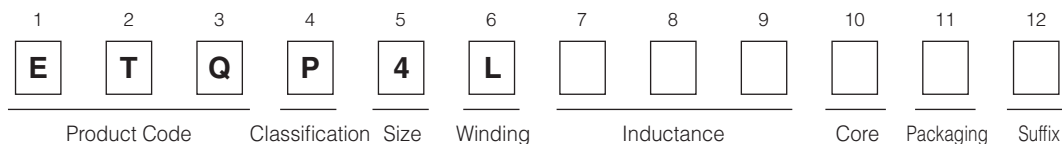

Standard Parts

Part No.	Inductance (at 20 °C)*1					Rated current (A)*2	Rated current (ref) (A)*3	DC resistance (at 20 °C) (mΩ)
	L0 at 0A	L1		L2 (Reference)*4				
	(μH)	(μH)	Measurement current (A)	(μH)	Measurement current (A)			
ETQP4LR19WFC	(0.20)	0.19±20 %	21	(0.17)	30	28	38	0.70±10 %
ETQP4LR36WFC	(0.37)	0.36±20 %	17	(0.34)	24	24	33	1.10± 5 %
ETQP4LR56WFC	(0.60)	0.56±20 %	15	(0.53)	21	21	28	1.56± 5 %
ETQP4LR45XFC	0.45 ^{+20%} / _{-25%}	—	—	(0.38)	25	25	33	1.10± 5 %

(*1) Inductance is measured at 100 kHz.

(*2) Rated current defines actual value of DC current, when temperature rise of coil becomes 40 K. (Method A)

(*3) Rated current defines actual value of DC current, when temperature rise of coil becomes 40 K. (Method B)

(*4) Reference only

(*5) Method A (PANASONIC's standard measurement conditions),

Method B (high heat dissipation measurement) is different from Method A by the measurement methods.

In normal application condition, the part's temperature depends on circuit design and heat dissipation condition.

This condition shall be verified by the worst operational condition.

Performance Characteristics (Reference)

Inductance vs DC Current

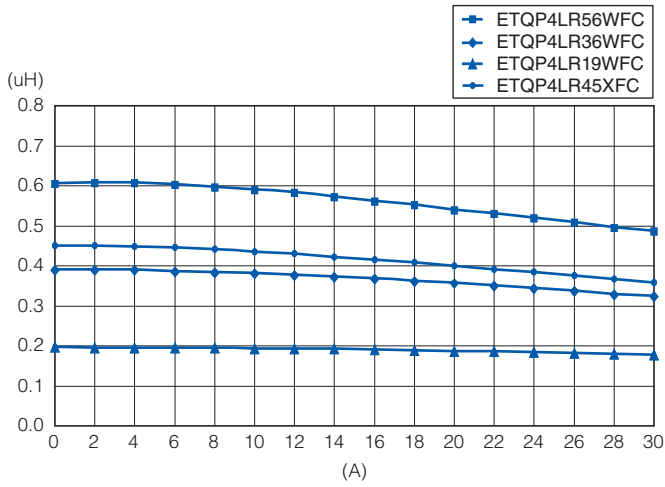

Case Temperature vs DC Current (Method A)

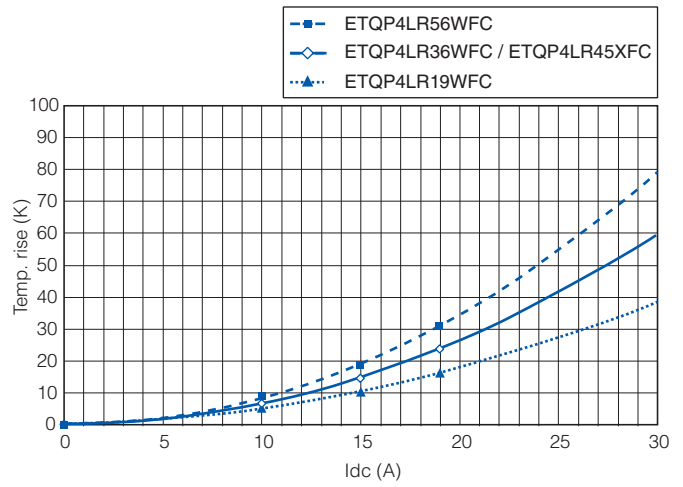

Dimensions in mm (not to scale)

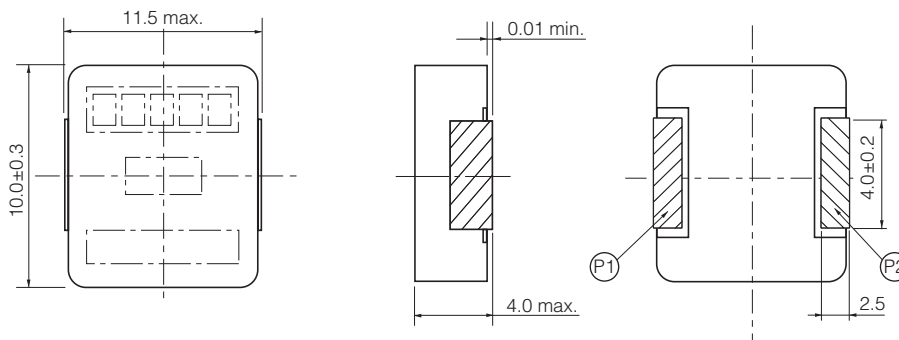

Connection

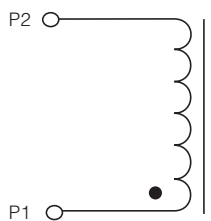

Recommended land patterns in mm (not to scale)

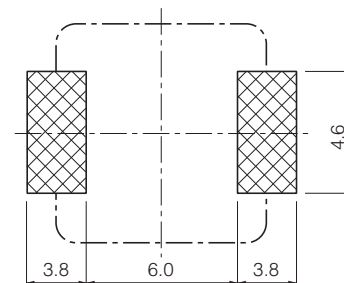

As for Packaging Methods, Soldering Conditions and Safety Precautions (Power Choke Coils for Consumer use),

Please see Data Files

Power Choke Coil

Series : **PCC-M1040L (MC)**
Low DCR Type



Small mounting size
 for multi-phase DC/DC converter circuits

Features

- Small type (11.7×10.0×H4.0 mm)
- High power (21 A to 30 A)
- Low loss (R_{DC} :0.76 to 1.58 mΩ)
- Tighter DCR tolerance (±5 %)
- Suitable for high frequency circuit (up to 1 MHz)
- Low buzz noise due to its gap-less structure
- Shielded construction
- RoHS compliant

Recommended Applications

- Notebook PC power supply modules
- Servers, Routers, DC/DC converters for driving CPUs

Standard Packing Quantity (Minimum Quantity/Packing Unit)

- 2,000 pcs./box (2 reel)

Explanation of Part Numbers

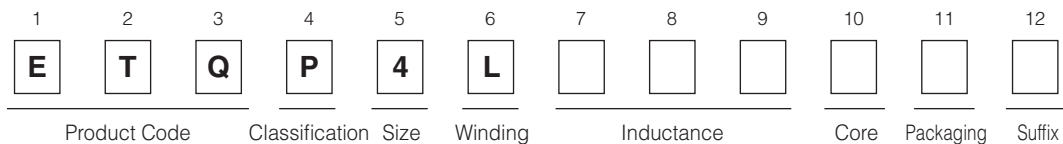

Standard Parts

Part No.	Inductance (at 20 °C)*1			Rated current (A)*2	Rated current (ref) (A)*3	DC resistance (at 20 °C) (mΩ)
	L0 at 0A	L1 *4				
	(μH)	(μH)	Measurement current (A)			
ETQP4LR36AFC	0.36±20 %	(0.29)	30	30	40	0.76±5 %
ETQP4LR68XFC	0.68±20 %	(0.59)	21	21	28	1.58±5 %

(*1) Inductance is measured at 1.0 MHz.

(*2) Rated current defines actual value of DC current, when temperature rise of coil becomes 40 K. (Method A)

(*3) Rated current defines actual value of DC current, when temperature rise of coil becomes 40 K. (Method B)

(*4) Reference only

(*5) Method A (PANASONIC's standard measurement conditions),

Method B (high heat dissipation measurement) is different from Method A by the measurement methods.

In normal application condition, the part's temperature depends on circuit design and heat dissipation condition.

This condition shall be verified by the worst operational condition.

Performance Characteristics (Reference)

Inductance vs DC Current

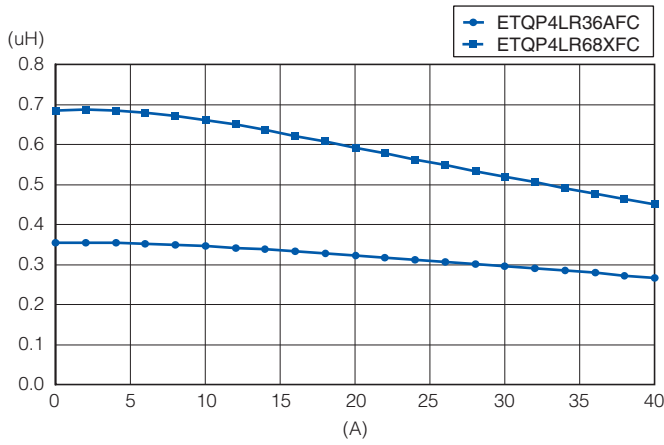

Case Temperature vs DC Current (Method A)

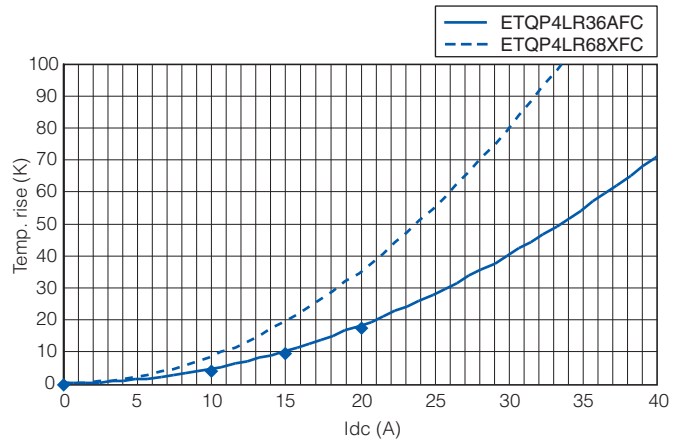

Dimensions in mm (not to scale)

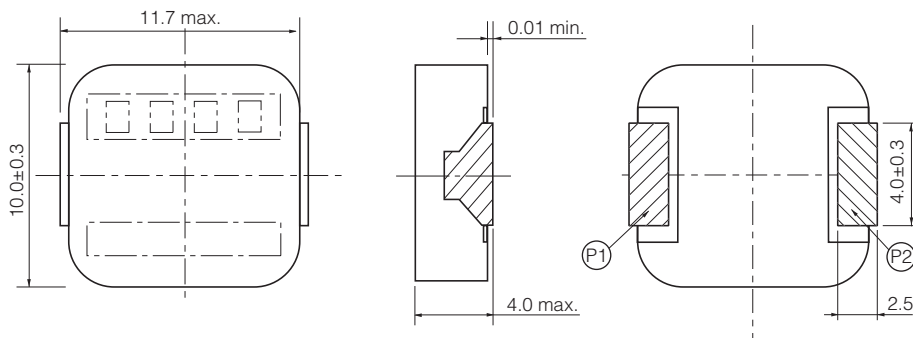

Connection

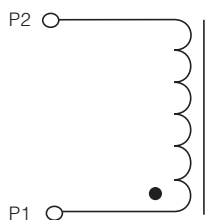

Recommended land patterns in mm (not to scale)

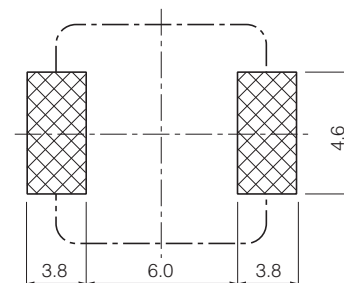

As for Packaging Methods, Soldering Conditions and Safety Precautions (Power Choke Coils for Consumer use),

Please see Data Files

Power Choke Coil

Series : **PCC-M1250L (MC)**



High power, Low loss, Low-profile

Features

- High power (25 A to 30 A)
- Low loss (R_{DC} :0.8 to 1.1 m Ω)
- Narrow R_{DC} tolerance (± 5 % to ± 7 %)
- Low profile (14.5×12.5×H5.0 mm)
- High frequency (up to 1 MHz)
- Low buzz noise due to its gap-less structure
- RoHS compliant

Recommended Applications

- Servers, Routers, DC/DC converters for driving CPUs
- Notebook PC power supply modules

Standard Packing Quantity (Minimum Quantity/Packing Unit)

- 1,000 pcs./box (2 reel)

Explanation of Part Numbers

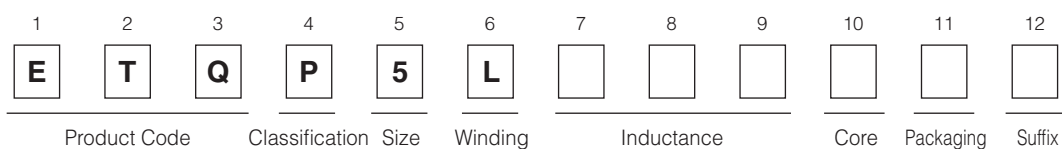

Standard Parts

Part No.	Inductance (at 20 °C)*1				Rated current (A)*2	DC resistance (at 20 °C) (m Ω)
	L1		L2 (Reference)			
	(μ H)	Measurement current (A)	(μ H)	Measurement current (A)		
ETQP5LR50XFA	0.50 \pm 20 %	30	(0.46)	42	30	0.80 \pm 7 %
ETQP5LR60XFA	0.60 \pm 20 %	30	(0.54)	42	27	1.10 \pm 5 %

(*1) Inductance is measured at 100 kHz.

(*2) Rated current defines actual value of DC current, when temperature rise of coil becomes 40 K.

Performance Characteristics (Reference)

Inductance vs DC Current

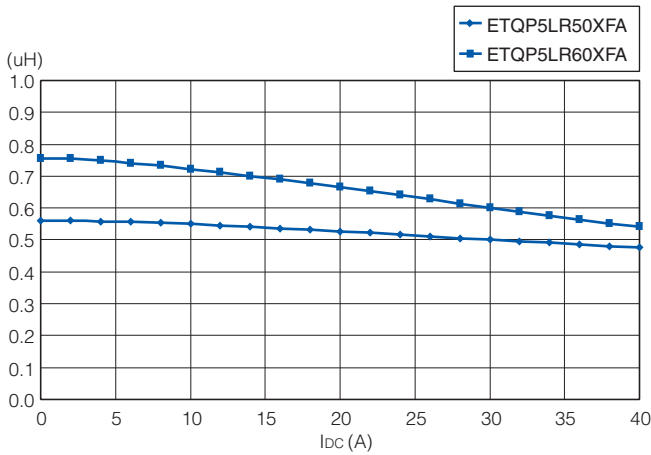

Case Temperature vs DC Current

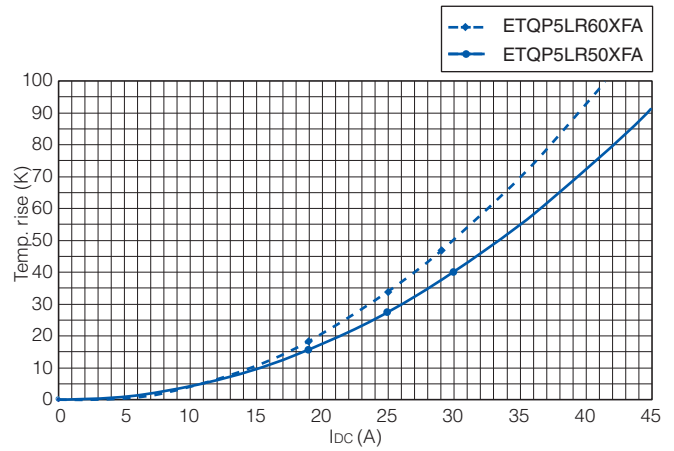

Dimensions in mm (not to scale)

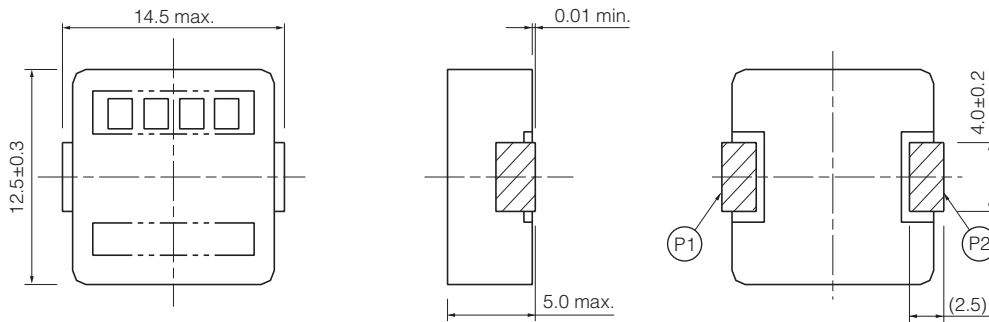

Connection

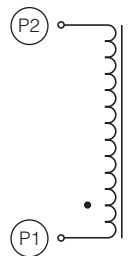

Recommended land patterns in mm (not to scale)

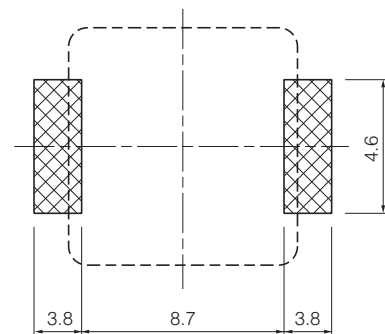

■ **As for Packaging Methods, Soldering Conditions and Safety Precautions (Power Choke Coils for Consumer use),**
Please see Data Files

Packaging Methods (Taping)

- Embossed Carrier Tape Dimensions in mm (not to scale)

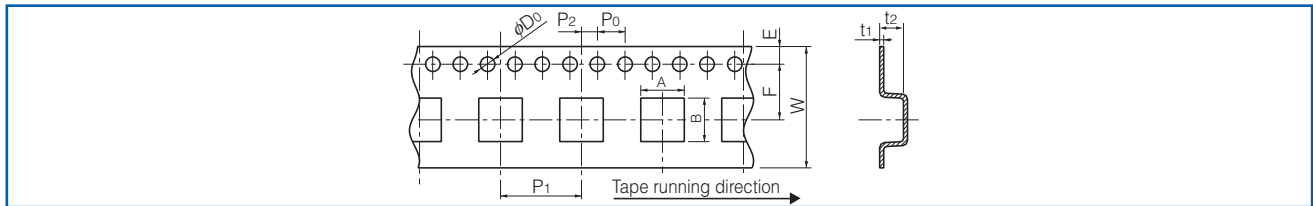

Power Choke Coils for consumer use

Series	A	B	W	E	F	P ₁	P ₂	P ₀	φD ₀	t ₁	t ₂
PCC-M0730L	7.6	8.9	16.0	1.75	7.5	12.0	2.0	4.0	1.5	0.4	4.2
PCC-M0740L	7.6	8.9			4.3						
PCC-M1040L	10.6	11.8	24.0		11.5	16.0					5.2
PCC-M1250L	13.1	14.8			5.3						

- Taping Reel Dimensions in mm (not to scale)

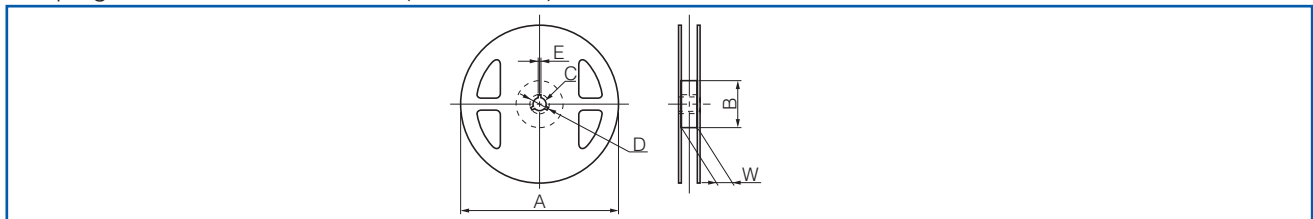

Power Choke Coils for consumer use

Series	A	B	C	D	E	W
PCC-M0730L/M0740L	380	80	13	21	2	17.5
PCC-M1040L						25.4
PCC-M1250L						

Standard Packing Quantity/Reel

- Power Choke Coils for consumer use

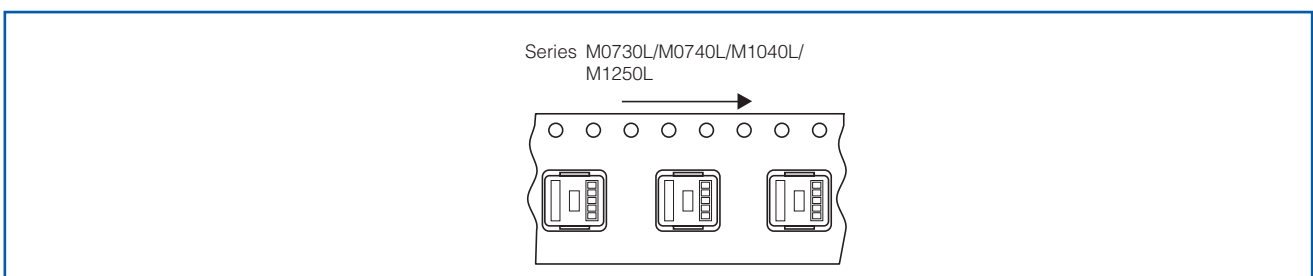

Standard Packing Quantity/Reel

- Power Choke Coils for consumer use

Series	Part No.	Minimum Quantity / Packing Unit	Quantity per reel
PCC-M0730L	ETQP3L□□□CFM	3,000 pcs. / box (2 reel)	1,500 pcs.
PCC-M0740L	ETQP4L□□□AFM		
PCC-M1040L	ETQP4L□□□WFC	2,000 pcs. / box (2 reel)	1,000 pcs.
	ETQP4L□□□XFC		
	ETQP4L□□□AFC		
PCC-M1040L	ETQP4LR19WFC	1,000 pcs. / box (2 reel)	500 pcs.
PCC-M1250L	ETQP5L□□□XFA		

Soldering Conditions

Reflow soldering conditions

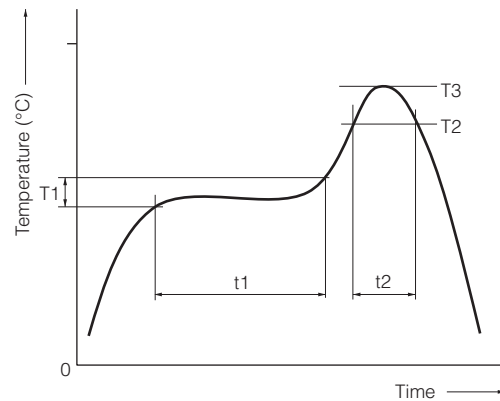

- Pb free solder recommended temperature profile
Power Choke Coils for consumer use

Series	Preheat		Soldering		Peak Temperature		Time of Reflow
	T1 [°C]	t1 [s]	T2 [°C]	t2 [s]	T3	T3 Limit	
PCC-M0730L PCC-M0740L PCC-M1040L PCC-M1250L	150 to 170	60 to 120	230 °C	30 to 40	250 °C, 5 s	260 °C, 10 s	2 times max.

⚠ Safety Precautions

(Common precautions for Power Choke Coils for consumer use)

- When using our products, no matter what sort of equipment they might be used for, be sure to make a written agreement on the specifications with us in advance. The design and specifications in this catalog are subject to change without prior notice.
- Do not use the products beyond the specifications described in this catalog.
- This catalog explains the quality and performance of the products as individual components. Before use, check and evaluate their operations when installed in your products.
- Install the following systems for a failsafe design to ensure safety if these products are to be used in equipment where a defect in these products may cause the loss of human life or other significant damage, such as damage to vehicles (automobile, train, vessel), traffic lights, medical equipment, aerospace equipment, electric heating appliances, combustion/gas equipment, rotating equipment, and disaster/crime prevention equipment.
- * Systems equipped with a protection circuit and a protection device
- * Systems equipped with a redundant circuit or other system to prevent an unsafe status in the event of a single fault

⚠ Precautions for use

1. Provision to abnormal condition

This power choke coil itself does not have any protective function in abnormal condition such as overload, short-circuit and open-circuit conditions, etc.

Therefore, it shall be confirmed as the end product that there is no risk of smoking, fire, dielectric withstand voltage, insulation resistance, etc. in abnormal conditions to provide protective devices and/or protection circuit in the end product.

2. Temperature rise

Temperature rise of power choke coil depends on the installation condition in end products. It shall be confirmed in the actual end product that temperature rise of power choke coil is in the limit of specified temperature class.

3. Dielectric strength

Dielectric withstanding test with higher voltage than specific value will damage Insulating material and shorten its life.

4. Water

This Power choke coil must not be used in wet condition by water, coffee or any liquid because insulation strength becomes very low in such condition.

5. Potting

If this power choke coil is potted in some compound, coating material of magnet wire might be occasionally damaged. Please ask us if you intend to pot this power choke coil.

6. Detergent

Please consult our company when using detergent for the power choke coil as reliability confirmation etc., is necessary.

7. Storage temperature

-5 °C to +35 °C

8. Operating temperature

Minimum temperature : -40 °C (Ambient temperature of the power choke coil)

Maximum temperature : 130 °C (Ambient temperature of the power choke coil plus the temperature rise)

100 °C (Only series : PCC-F126F(N6))

9. Model

When this power choke coil is used in a similar or new product to the original one, it might be unable to satisfy the specifications due to difference of condition of usage.

Please ask us if you use this power choke coil in the manner such as above.

10. Drop

If the power choke coil receives mechanical stress such as drop, characteristics may become poor (due to damage on coil bobbin, etc.). Never use such stressed power choke coil.

<Package markings>

Package markings include the product number, quantity, and country of origin.

In principle, the country of origin should be indicated in English.

Voltage Step-up Coils

Series : **Chip**
Type : **3KN**



ELT3KN

High inductance Voltage Step-up coil chip series for piezoelectric buzzers and DC/DC circuitry of EL panels

Features

- Small and thin
- High inductance
- RoHS compliant

Recommended Applications

- Piezoelectric buzzer, Booster circuit for EL backlight (Watch, Electric thermometer, Portable device)
- HAC inductor (Smartphone, Cellular phone)

Explanation of Part Numbers

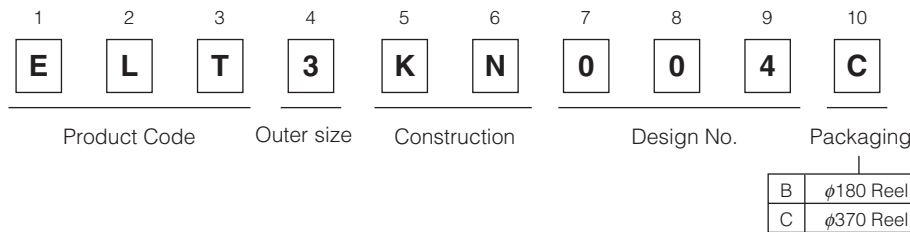

Standard Packing Quantity

- 1,000 or 5,000 pcs./reel

Dimensions in mm (not to scale)

- Type 3KN

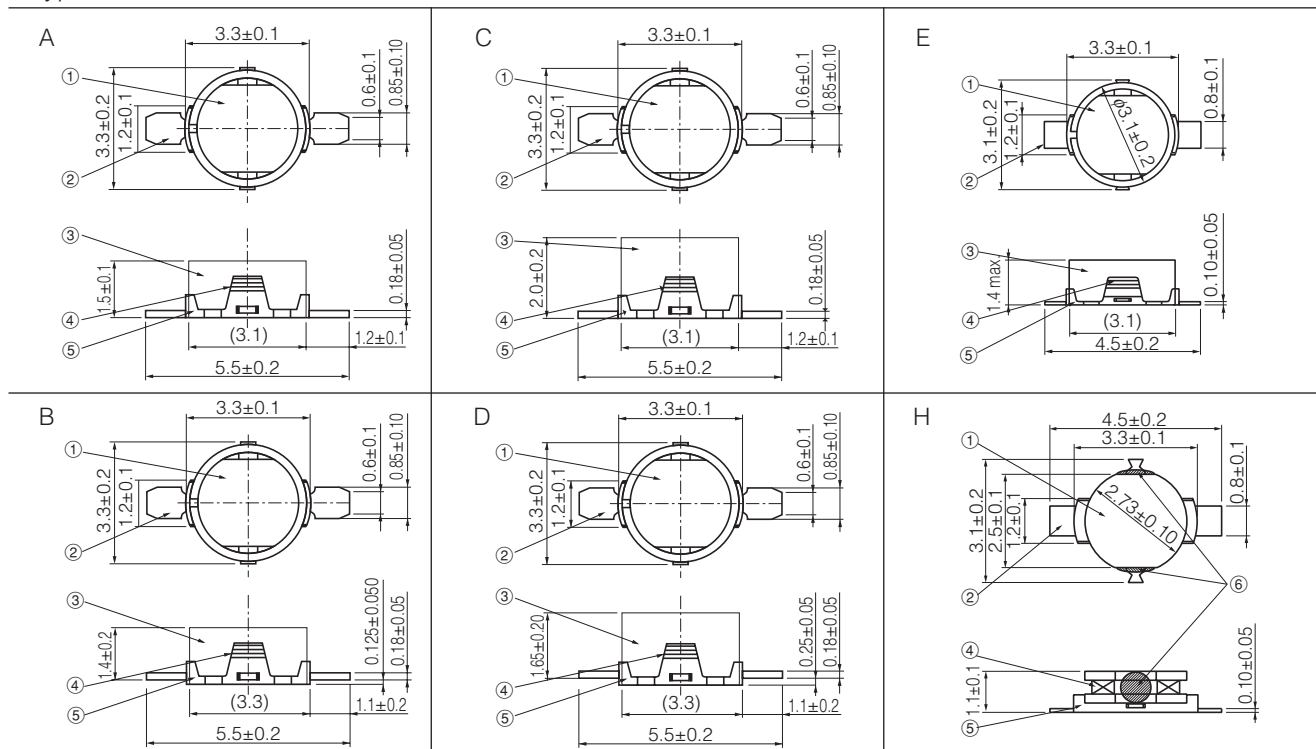

Part Name: ① Core ② Terminal ③ Ring ④ Coil ⑤ Terminal board ⑥ Adhesive

Design and specifications are each subject to change without notice. Ask factory for the current technical specifications before purchase and/or use.
Should a safety concern arise regarding this product, please be sure to contact us immediately.

Standard Parts

Part No.	Inductance		R. D. C		I.D.C (mA) max.	Dimensions	Magnetic Composition			
	(mH)	Tolerance(%)	(Ω)	Tolerance(%)						
ELT3KN004□	14.00	±40	125	±10	1.7	A	Permalloy ring			
ELT3KN007□	20.00		170		1.4					
ELT3KN113□	1.00	±10	34	±15	25.0		Brass ring			
ELT3KN126□	1.50		49		29.0					
ELT3KN142□	0.82		24		30.0					
ELT3KN019□	14.00	±40	125	±10	1.7		B	Permalloy ring		
ELT3KN109□	3.80	±10	115	±20	15.0	Brass ring				
ELT3KN114□	2.50		83	±15	15.0					
ELT3KN014□	30.00	±40	150	±10	1.9	C	Permalloy ring			
ELT3KN018□	35.00		235		1.9					
ELT3KN028□	50.00	±35	250	±15	1.4					
ELT3KN032□	25.00	±40	185		10.0					
ELT3KN101□	10.00	±10	285	±10	1.4			Brass ring		
ELT3KN104□	1.00		35	±15	30.0					
ELT3KN118□	2.50		64		20.0					
ELT3KN121□	1.00		22.5		40.0					
ELT3KN122□	2.00		44		20.0					
ELT3KN123□	1.00		25		30.0					
ELT3KN124□	4.00		85		15.0					
ELT3KN127□	0.47		14		50.0					
ELT3KN128□	0.56		15		45.0					
ELT3KN129□	0.68		17		34.0					
ELT3KN130□	2.30		51		23.0					
ELT3KN131□	2.00		44		20.0					
ELT3KN020□	30.00		±30		150	±10	2.5		D	Permalloy ring
ELT3KN111□	7.50		±10		177		10.0			Brass ring
ELT3KN125□	4.00	85			15.0					
ELT3KN041□	14.00	±40	125	±10	1.7	E	Permalloy ring			
ELT3KN042□	20.00		175		1.4					
ELT3KN043□	12.00		117		1.7					
ELT3KN139□	0.68	±10	19	±15	40.0	Brass ring				
ELT3KN140□	0.82		22		30.0					
ELT3KN135□	1.10		32		30.0					
ELT3KN136□	2.00		55		20.0					
ELT3KN137□	4.00		117	±10	15.0					
ELT3KN149□	0.33		11	±15	60.0					
ELT3KN151□	0.56		17		50.0					
ELT3KN152□	0.47		14		50.0					
ELT3KN155□	1.10		38	±10	25.0		H	Ring less		
ELT3KN162□	4.00		117		15.0		E	Brass ring		
ELT3KN163□	1.10	32	±15		30.0					

“□” shows the packaging specifications.

Packaging Methods

● Standard Packing Quantity

Packaging	ELT3KN	Kind of Taping
B	1,000 pcs.	Embossed Carrier Taping
C	5,000 pcs.	

● Reel Dimensions in mm (not to scale)

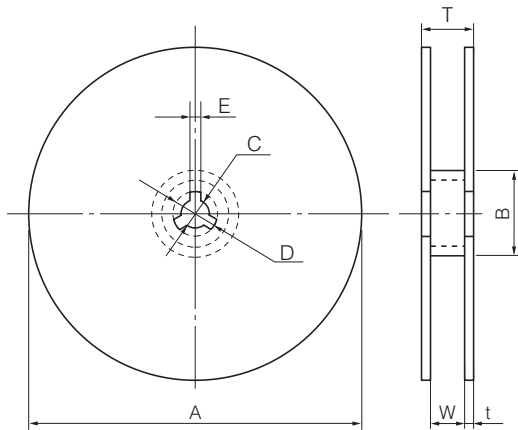

Packaging	A	B	C	D	E	W	t	T
B	180	60	13	21	2	13	1.1	15.2
C	370	60	13	21	2	14	2.0	18

● Embossed Carrier Tape Dimensions in mm (not to scale)

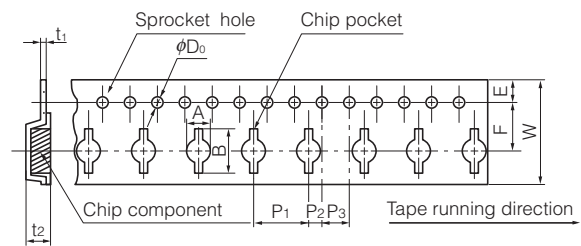

Part No.	A	B	W	F	E	P_1
ELT3KN	3.7	6.4	12.0	5.5	1.75	8.0

Part No.	P_2	P_3	ϕD_0	t_1	t_2
ELT3KN	2.0	4.0	1.5	0.3	2.6

● Leader Part, Vacant Position

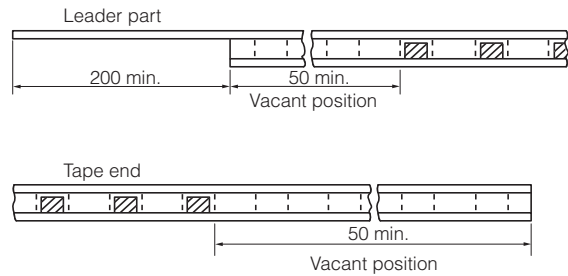

Applied Diagram Examples

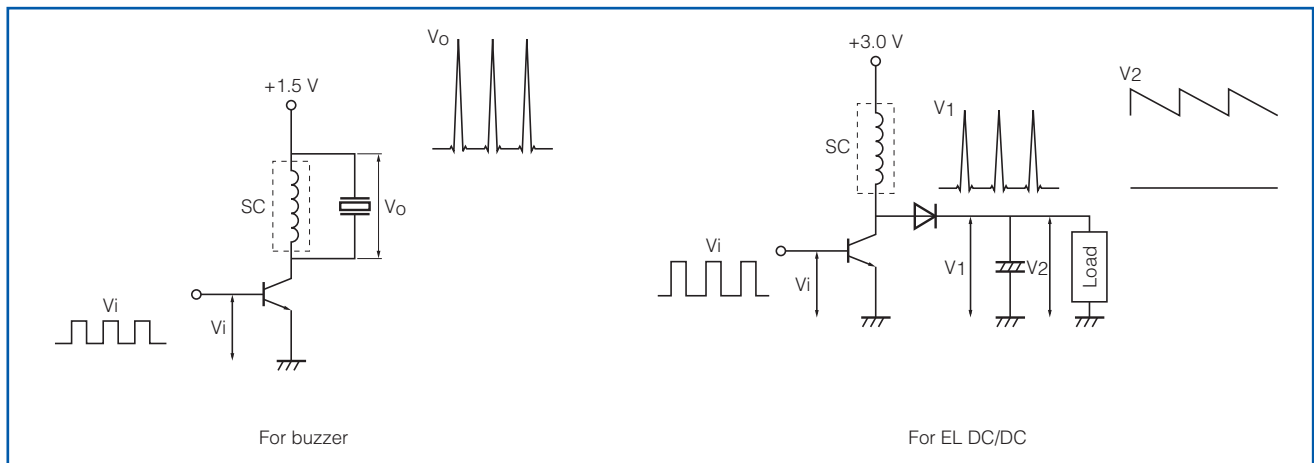

Soldering Conditions

Reflow soldering conditions

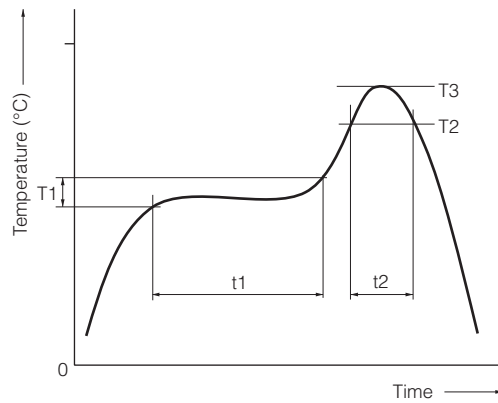

● Pb free solder recommended temperature profile

Part No.	Preheat		Soldering		Peak Temperature		Time of Reflow
	T1 [°C]	t1 [s]	T2 [°C]	t2 [s]	T3	T3 Limit	
ELT3KN	150 to 170	60 to 120	230 °C	30 max.	245 °C, 10 s	260 °C, 10 s	2 times max.

⚠ Safety Precautions

(Common precautions for Voltage Step-up Coils)

- When using our products, no matter what sort of equipment they might be used for, be sure to make a written agreement on the specifications with us in advance. The design and specifications in this catalog are subject to change without prior notice.
- Do not use the products beyond the specifications described in this catalog.
- This catalog explains the quality and performance of the products as individual components. Before use, check and evaluate their operations when installed in your products.
- Install the following systems for a failsafe design to ensure safety if these products are to be used in equipment where a defect in these products may cause the loss of human life or other significant damage, such as damage to vehicles (automobile, train, vessel), traffic lights, medical equipment, aerospace equipment, electric heating appliances, combustion/gas equipment, rotating equipment, and disaster/crime prevention equipment.
- * Systems equipped with a protection circuit and a protection device
- * Systems equipped with a redundant circuit or other system to prevent an unsafe status in the event of a single fault

⚠ Precautions for use

1. Operation range and environments

- ① These products are designed and manufactured for general and standard use in general electronic equipment (e.g. AV equipment, home electric appliances, office equipment, information and communication equipment)
- ② These products are not designed for the use in the following special conditions. Before using the products, carefully check the effects on their quality and performance, and determine whether or not they can be used.
 - In liquid, such as water, oil, chemicals, or organic solvent
 - In direct sunlight, outdoors, or in dust
 - In salty air or air with a high concentration of corrosive gas, such as Cl₂, H₂S, NH₃, SO₂, or NO₂
 - In an environment where these products cause dew condensation

2. Handling

- ① Do not bring magnets or magnetized materials close to the product. The influence of their magnetic field can change the inductance value.
- ② Do not apply strong mechanical shocks by either dropping or collision with other parts. Excessive shock can damage the part.

3. Resoldering with a soldering iron

- ① Resoldering should be done within 3 seconds by soldering iron, the temperature with 350 °C or less and should be cooling down after ward. Both side of terminals shall be fixed closely to PWB. And terminals shall not be pressed in heating.

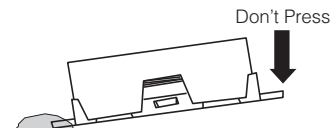

- ② The wiring tab shall not be held by sharp-edged tool.

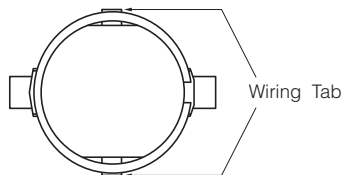

- ③ Iron shall not be put to the component itself.

4. Mounting side

- ① External force must be less than 4.9N while mounting.
- ② The wiring tab is expose the terminal, so please be careful when you design PWB pattern of coil circumference.

5. Cleaning

If you clean the inductor, please use own your ultrasonic cleaning to check specified conditions.

6. Storage conditions

Normal temperature (−5 to 35 °C), normal humidity (85 % RH max.), shall not be exposed to direct sunlight and harmful gases and care should be taken so as not to cause dew.

<Package markings>

Package markings include the product number, quantity, and country of origin. In principle, the country of origin should be indicated in English.

Guidelines and precautions regarding the technical information and use of our products described in this online catalog.

- If you want to use our products described in this online catalog for applications requiring special qualities or reliability, or for applications where the failure or malfunction of the products may directly jeopardize human life or potentially cause personal injury (e.g. aircraft and aerospace equipment, traffic and transportation equipment, combustion equipment, medical equipment, accident prevention, anti-crime equipment, and/or safety equipment), it is necessary to verify whether the specifications of our products fit to such applications. Please ensure that you will ask and check with our inquiry desk as to whether the specifications of our products fit to such applications use before you use our products.
- The quality and performance of our products as described in this online catalog only apply to our products when used in isolation. Therefore, please ensure you evaluate and verify our products under the specific circumstances in which our products are assembled in your own products and in which our products will actually be used.
- If you use our products in equipment that requires a high degree of reliability, regardless of the application, it is recommended that you set up protection circuits and redundancy circuits in order to ensure safety of your equipment.
- The products and product specifications described in this online catalog are subject to change for improvement without prior notice. Therefore, please be sure to request and confirm the latest product specifications which explain the specifications of our products in detail, before you finalize the design of your applications, purchase, or use our products.
- The technical information in this online catalog provides examples of our products' typical operations and application circuits. We do not guarantee the non-infringement of third party's intellectual property rights and we do not grant any license, right, or interest in our intellectual property.
- If any of our products, product specifications and/or technical information in this online catalog is to be exported or provided to non-residents, the laws and regulations of the exporting country, especially with regard to security and export control, shall be observed.

<Regarding the Certificate of Compliance with the EU RoHS Directive/REACH Regulations>

- The switchover date for compliance with the RoHS Directive/REACH Regulations varies depending on the part number or series of our products.
- When you use the inventory of our products for which it is unclear whether those products are compliant with the RoHS Directive/REACH Regulation, please select "Sales Inquiry" in the website inquiry form and contact us.

We do not take any responsibility for the use of our products outside the scope of the specifications, descriptions, guidelines and precautions described in this online catalog.

CAUTION AND WARNING

1. The electronic components contained in this catalog are designed and produced for use in home electric appliances, office equipment, information equipment, communications equipment, and other general purpose electronic devices.
Before use of any of these components for equipment that requires a high degree of safety, such as medical instruments, aerospace equipment, disaster-prevention equipment, security equipment, vehicles (automobile, train, vessel), please be sure to contact our sales representative.
2. When applying one of these components for equipment requiring a high degree of safety, no matter what sort of application it might be, be sure to install a protective circuit or redundancy arrangement to enhance the safety of your equipment. In addition, please carry out the safety test on your own responsibility.
3. When using our products, no matter what sort of equipment they might be used for, be sure to make a written agreement on the specifications with us in advance.
4. Technical information contained in this catalog is intended to convey examples of typical performances and/or applications and is not intended to make any warranty with respect to the intellectual property rights or any other related rights of our company or any third parties nor grant any license under such rights.
5. In order to export products in this catalog, the exporter may be subject to the export license requirement under the Foreign Exchange and Foreign Trade Law of Japan.
6. No ozone-depleting substances (ODSs) under the Montreal Protocol are used in the manufacturing processes of Industrial Solutions Company, Panasonic Corporation.
7. The information contained on this material may not be reprinted or reproduced whether wholly or in part, without the prior written permission of Panasonic Corporation.

Safety Precautions

- When using our products, no matter what sort of equipment they might be used for, be sure to confirm the applications and environmental conditions with our specifications in advance.

● Please contact _____

● Factory _____

Device Solutions Business Division
Industrial Solutions Company
Panasonic Corporation
1006 Kadoma, Kadoma City, Osaka 571-8506,
JAPAN

The information in this catalog is valid as of June, 2019.