

## Thermal Management Solutions

Products Catalog



**Guidelines and precautions regarding the technical information and use of our products described in this online catalog.**

- If you want to use our products described in this online catalog for applications requiring special qualities or reliability, or for applications where the failure or malfunction of the products may directly jeopardize human life or potentially cause personal injury (e.g. aircraft and aerospace equipment, traffic and transportation equipment, combustion equipment, medical equipment, accident prevention, anti-crime equipment, and/or safety equipment), it is necessary to verify whether the specifications of our products fit to such applications. Please ensure that you will ask and check with our inquiry desk as to whether the specifications of our products fit to such applications use before you use our products.
- The quality and performance of our products as described in this online catalog only apply to our products when used in isolation. Therefore, please ensure you evaluate and verify our products under the specific circumstances in which our products are assembled in your own products and in which our products will actually be used.
- If you use our products in equipment that requires a high degree of reliability, regardless of the application, it is recommended that you set up protection circuits and redundancy circuits in order to ensure safety of your equipment.
- The products and product specifications described in this online catalog are subject to change for improvement without prior notice. Therefore, please be sure to request and confirm the latest product specifications which explain the specifications of our products in detail, before you finalize the design of your applications, purchase, or use our products.
- The technical information in this online catalog provides examples of our products' typical operations and application circuits. We do not guarantee the non-infringement of third party's intellectual property rights and we do not grant any license, right, or interest in our intellectual property.
- If any of our products, product specifications and/or technical information in this online catalog is to be exported or provided to non-residents, the laws and regulations of the exporting country, especially with regard to security and export control, shall be observed.

**<Regarding the Certificate of Compliance with the EU RoHS Directive/REACH Regulations>**

- The switchover date for compliance with the RoHS Directive/REACH Regulations varies depending on the part number or series of our products.
- When you use the inventory of our products for which it is unclear whether those products are compliant with the RoHS Directive/REACH Regulation, please select "Sales Inquiry" in the website inquiry form and contact us.

**We do not take any responsibility for the use of our products outside the scope of the specifications, descriptions, guidelines and precautions described in this online catalog.**

# Thermal Management Solutions CONTENTS

| Product Item   | Part Number          | Page |
|--|----------------------|------|
|  | The NTC Thermistors  | 1    |
| Multilayer NTC Thermistors   | ERT JZ               | 2    |
|  | ERT J0               |      |
|  | ERT J1               |      |
|  | Handling Precautions | 10   |
| Multilayer NTC Thermistors<br>(Automotive Grade)                     | ERT J0 M             | 18   |
|  | ERT J1 M             | 23   |
|  | Handling Precautions |      |
| "PGS" Graphite Sheets<br>SSM(Semi-Sealing Material)                  | EYG S                | 31   |
|  | EYG A                |      |
|  | EYG E                |      |
|  | Minimum order        | 37   |
|  | Handling Precautions | 39   |
| "NASBIS" Insulating Sheet  | EYG Y                | 41   |
|  | Handling Precautions | 43   |
| "Graphite-PAD" high thermal conductivity in z-direction              | EYG T                | 45   |
|  | Handling Precautions | 48   |
| "GraphiteTIM (Compressible Type)" PGS<br>with low thermal resistance | EYG S                | 50   |
|  | Handling Precautions | 54   |

## The NTC Thermistors

NTC Thermistors is a negative temperature coefficient resistor that significantly reduces its resistance value as the heat/ ambient temperature rises. Thermistors is sintered in high-temperature (1200 °C to 1500 °C), and manufactured in various shapes. It's comprised of 2 to 4 kinds of metal oxides: iron, nickel, cobalt, manganese and copper.

### Features

- Temperature Coefficient of Resistance is negative, and it's extremely large (-2.8 to -5.1 [%/°C]).
- Various shapes, especially compact size components are available.
- Selection of resistance value is comparatively free, it's available from several tens Ω to several hundred kΩ.

### Recommended Applications

- For temperature measurement or temperature detection : Thermometer, temperature controller
- For temperature compensation : Transistor, transistor circuit, quartz oscillation circuit, and measuring instruments

### Physical Characteristics of NTC Thermistors

Thermistor is a resistor sensitive to temperature that is utilizing the characteristic of metal oxide semiconductor having large temperature coefficient. And its temperature dependency of resistance value is indicated by the following equation :

$$R=R_0 \exp \left[ B \left( \frac{1}{T} - \frac{1}{T_0} \right) \right] \dots\dots\dots(1)$$

$T_0$  : Standard Temperature 298.15 K(25 °C)  
 $R_0$  : Resistance at  $T_0$  [K]  
 $B$  : Thermistor Constant [K]

Temperature coefficient ( $\alpha$ ) in general meaning is indicated as follows :

$$\alpha = -\frac{B}{T^2} \dots\dots\dots(2)$$

Since the change by temperature is considerably large,  $\alpha$  is not appropriate as a constant. Therefore, B value (constant) is generally used as a coefficient of thermistors.

### Major Characteristics of NTC Thermistors

The relation between resistance and temperature of a thermistor is linear as shown in Fig. 2. The resistance value is shown in vertical direction in a logarithmic scale and reciprocal of absolute temperature (adding 273.15 to centigrade) is shown in horizontal direction.

The B value (constant) determines the gradient of these straight lines. The B value (constant) is calculated by using following equation.

$$B = \frac{\ln R_1 - \ln R_2}{\frac{1}{T_1} - \frac{1}{T_2}} \dots\dots\dots(3)$$

$R_1$ : Resistance at  $T_1$  K  
 $R_2$ : Resistance at  $T_2$  K

When you calculate this equation, you'll find that B value is not exactly constant. The resistance is expressed by the following equation :

$$R = AT^{-C} \exp D/T \dots\dots\dots(4)$$

In (4), C is a small positive or negative constant and quite negligible except for use in precision temperature-measuring device, therefore, the B value can be considered as constant number.

In Fig. 1, the relation between the resistance ratio  $R_T/R_{25}$  ( $R_{25}$ : Resistance at 25 °C,  $R_T$ : Resistance at T °C) and B Value is shown with T °C, in the horizontal direction.

Fig. 1

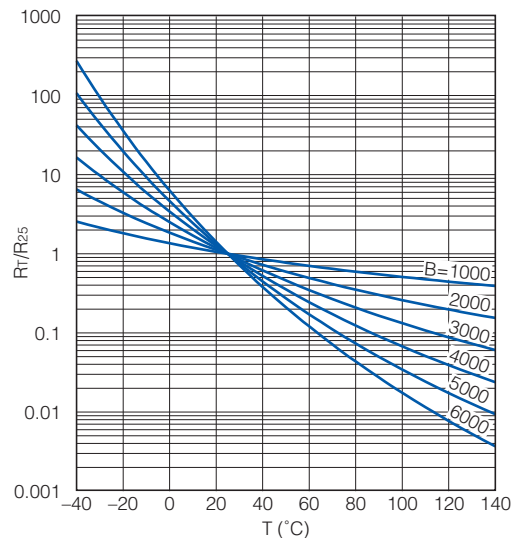

Fig. 2



## Multilayer NTC Thermistors

Series: **ERTJ**



### Features

- Surface Mount Device (0201, 0402, 0603)
- Highly reliable multilayer / monolithic structure
- Wide temperature operating range (-40 to 125 °C)
- Environmentally-friendly lead-free
- RoHS compliant

### Recommended Applications

- Mobile Phone
  - Temperature compensation for crystal oscillator
  - Temperature compensation for semiconductor devices
- Personal Computer and Peripheral Device
  - Temperature detection for CPU and memory device
  - Temperature compensation for ink-viscosity (Inkjet Printer)
- Battery Pack (secondary battery)
  - Temperature detection of battery cells
- Liquid Crystal Display
  - Temperature compensation of display contrast
  - Temperature compensation of display backlighting (CCFL)

### Explanation of Part Numbers

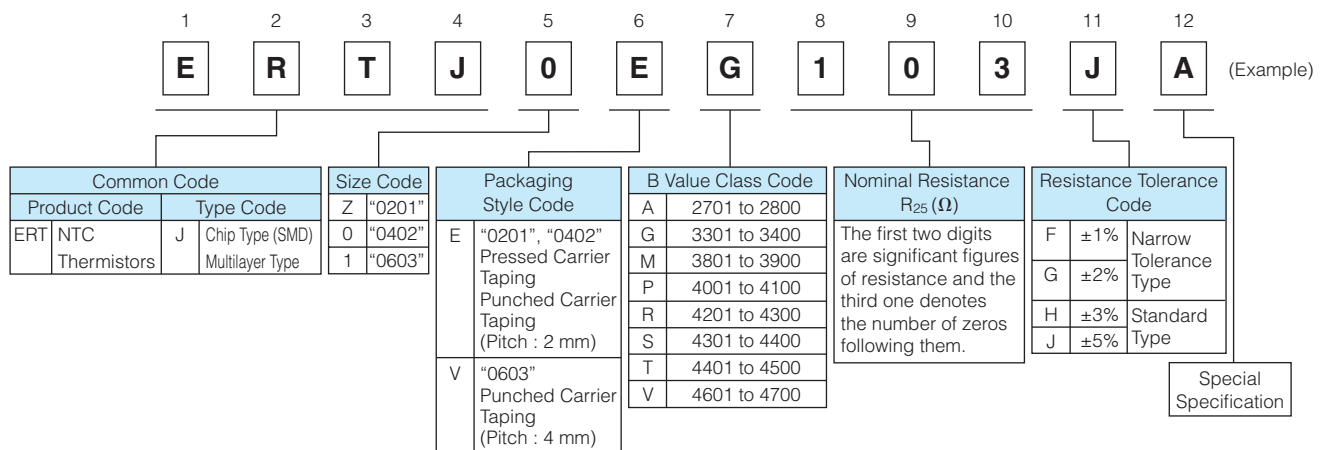

### Construction



| No. | Name                    |                        |
|-----|-------------------------|------------------------|
| ①   | Semiconductive Ceramics |                        |
| ②   | Internal electrode      |                        |
| ③   | Terminal electrode      | Substrate electrode    |
| ④   |                         | Intermediate electrode |
| ⑤   |                         | External electrode     |



## Ratings

| Size code (EIA)                   | Z(0201)                  | O(0402)                  | 1(0603)                  |
|-----------------------------------|--------------------------|--------------------------|--------------------------|
| Operating Temperature Range       | -40 to 125 °C            |                          |                          |
| Rated Maximum Power Dissipation*1 | 33 mW                    | 66 mW                    | 100 mW                   |
| Dissipation Factor*2              | Approximately<br>1 mW/°C | Approximately<br>2 mW/°C | Approximately<br>3 mW/°C |

- \*1 Rated Maximum Power Dissipation : The maximum power that can be continuously applied at the rated ambient temperature.  
 ·The maximum value of power, and rated power is same under the condition of ambient temperature 25 °C or less. If the temperature exceeds 25 °C, rated power depends on the decreased power dissipation curve.  
 ·Please see "Operating Power" for details.
- \*2 Dissipation factor : The constant amount power required to raise the temperature of the Thermistor 1 °C through self heat generation under stable temperatures.  
 ·Dissipation factor is the reference value when mounted on a glass epoxy board (1.6 mmT).

## Part Number List of Narrow Tolerance Type (Resistance Tolerance : $\pm 2\%$ , $\pm 1\%$ )

### ● 0201(EIA)

| Part Number  | Nominal Resistance at 25 °C | Resistance Tolerance                 | B Value at 25/50(K) | B Value at 25/85(K) |
|--------------|-----------------------------|--------------------------------------|---------------------|---------------------|
| ERTJZEG103□A | 10 kΩ                       | $\pm 1\%$ (F)<br>or<br>$\pm 2\%$ (G) | (3380 K)            | 3435 K $\pm 1\%$    |
| ERTJZEP473□  | 47 kΩ                       |                                      | 4050 K $\pm 1\%$    | (4100 K)            |
| ERTJZEP683□  | 68 kΩ                       |                                      | 4050 K $\pm 1\%$    | (4100 K)            |
| ERTJZER683□  | 68 kΩ                       |                                      | 4250 K $\pm 1\%$    | (4300 K)            |
| ERTJZER104□  | 100 kΩ                      |                                      | 4250 K $\pm 1\%$    | (4300 K)            |
| ERTJZET104□  | 100 kΩ                      |                                      | 4500 K $\pm 1\%$    | (4550 K)            |
| ERTJZEV104□  | 100 kΩ                      |                                      | 4700 K $\pm 1\%$    | (4750 K)            |

□ : Resistance Tolerance Code

### ● 0402(EIA)

| Part Number  | Nominal Resistance at 25 °C | Resistance Tolerance                 | B Value at 25/50(K) | B Value at 25/85(K) |
|--------------|-----------------------------|--------------------------------------|---------------------|---------------------|
| ERTJ0EG103□A | 10 kΩ                       | $\pm 1\%$ (F)<br>or<br>$\pm 2\%$ (G) | (3380 K)            | 3435 K $\pm 1\%$    |
| ERTJ0EP333□  | 33 kΩ                       |                                      | 4050 K $\pm 1\%$    | (4100 K)            |
| ERTJ0EP473□  | 47 kΩ                       |                                      | 4050 K $\pm 1\%$    | (4100 K)            |
| ERTJ0EP683□  | 68 kΩ                       |                                      | 4050 K $\pm 1\%$    | (4100 K)            |
| ERTJ0ER104□  | 100 kΩ                      |                                      | 4250 K $\pm 1\%$    | (4300 K)            |
| ERTJ0ES104□  | 100 kΩ                      |                                      | 4330 K $\pm 1\%$    | (4390 K)            |
| ERTJ0EV104□  | 100 kΩ                      |                                      | 4700 K $\pm 1\%$    | (4750 K)            |
| ERTJ0EV224□  | 220 kΩ                      |                                      | 4700 K $\pm 1\%$    | (4750 K)            |

□ : Resistance Tolerance Code

### ● 0603(EIA)

| Part Number  | Nominal Resistance at 25 °C | Resistance Tolerance                 | B Value at 25/50(K) | B Value at 25/85(K) |
|--------------|-----------------------------|--------------------------------------|---------------------|---------------------|
| ERTJ1VG103□A | 10 kΩ                       | $\pm 1\%$ (F)<br>or<br>$\pm 2\%$ (G) | (3380 K)            | 3435 K $\pm 1\%$    |
| ERTJ1VS104□A | 100 kΩ                      |                                      | (4330 K)            | 4390 K $\pm 1\%$    |

□ : Resistance Tolerance Code

## Part Number List of Standard Type (Resistance Tolerance : $\pm 5\%$ , $\pm 3\%$ )

### ● 0201(EIA)

| Part Number  | Nominal Resistance at 25 °C | Resistance Tolerance                 | B Value at 25/50(K) | B Value at 25/85(K) |
|--------------|-----------------------------|--------------------------------------|---------------------|---------------------|
| ERTJZET202□  | 2.0 kΩ                      | $\pm 3\%$ (H)<br>or<br>$\pm 5\%$ (J) | 4500 K $\pm 2\%$    | (4450 K)            |
| ERTJZET302□  | 3.0 kΩ                      |                                      | 4500 K $\pm 2\%$    | (4450 K)            |
| ERTJZET472□  | 4.7 kΩ                      |                                      | 4500 K $\pm 2\%$    | (4450 K)            |
| ERTJZEG103□A | 10 kΩ                       |                                      | (3380 K)            | 3435 K $\pm 1\%$    |
| ERTJZEP473□  | 47 kΩ                       |                                      | 4050 K $\pm 2\%$    | (4100 K)            |
| ERTJZEP683□  | 68 kΩ                       |                                      | 4050 K $\pm 2\%$    | (4100 K)            |
| ERTJZER683□  | 68 kΩ                       |                                      | 4250 K $\pm 2\%$    | (4300 K)            |
| ERTJZER104□  | 100 kΩ                      |                                      | 4250 K $\pm 2\%$    | (4300 K)            |
| ERTJZET104□  | 100 kΩ                      |                                      | 4500 K $\pm 2\%$    | (4550 K)            |
| ERTJZEV104□  | 100 kΩ                      |                                      | 4700 K $\pm 2\%$    | (4750 K)            |
| ERTJZET154□  | 150 kΩ                      |                                      | 4500 K $\pm 2\%$    | (4750 K)            |
| ERTJZET224□  | 220 kΩ                      |                                      | 4500 K $\pm 2\%$    | (4750 K)            |

□ : Resistance Tolerance Code

● 0402(EIA)

| Part Number  | Nominal Resistance at 25 °C | Resistance Tolerance     | B Value at 25/50(K) | B Value at 25/85(K) |
|--------------|-----------------------------|--------------------------|---------------------|---------------------|
| ERTJ0EA220□  | 22 Ω                        | ±3 %(H)<br>or<br>±5 %(J) | 2750 K±3 %          | (2700 K)            |
| ERTJ0EA330□  | 33 Ω                        |                          | 2750 K±3 %          | (2700 K)            |
| ERTJ0EA400□  | 40 Ω                        |                          | 2750 K±3 %          | (2700 K)            |
| ERTJ0EA470□  | 47 Ω                        |                          | 2750 K±3 %          | (2700 K)            |
| ERTJ0EA680□  | 68 Ω                        |                          | 2800 K±3 %          | (2750 K)            |
| ERTJ0EA101□  | 100 Ω                       |                          | 2800 K±3 %          | (2750 K)            |
| ERTJ0EA151□  | 150 Ω                       |                          | 2800 K±3 %          | (2750 K)            |
| ERTJ0ET102□  | 1.0 kΩ                      |                          | 4500 K±2 %          | (4450 K)            |
| ERTJ0ET152□  | 1.5 kΩ                      |                          | 4500 K±2 %          | (4450 K)            |
| ERTJ0ET202□  | 2.0 kΩ                      |                          | 4500 K±2 %          | (4450 K)            |
| ERTJ0ET222□  | 2.2 kΩ                      |                          | 4500 K±2 %          | (4450 K)            |
| ERTJ0ET302□  | 3.0 kΩ                      |                          | 4500 K±2 %          | (4450 K)            |
| ERTJ0ER332□  | 3.3 kΩ                      |                          | 4250 K±2 %          | (4300 K)            |
| ERTJ0ET332□  | 3.3 kΩ                      |                          | 4500 K±2 %          | (4450 K)            |
| ERTJ0ET472□  | 4.7 kΩ                      |                          | 4500 K±2 %          | (4450 K)            |
| ERTJ0ER472□  | 4.7 kΩ                      |                          | 4250 K±2 %          | (4300 K)            |
| ERTJ0ER682□  | 6.8 kΩ                      |                          | 4250 K±2 %          | (4300 K)            |
| ERTJ0EG103□A | 10 kΩ                       |                          | (3380 K)            | 3435 K±1 %          |
| ERTJ0EM103□  | 10 kΩ                       |                          | 3900 K±2 %          | (3970 K)            |
| ERTJ0ER103□  | 10 kΩ                       |                          | 4250 K±2 %          | (4300 K)            |
| ERTJ0ER153□  | 15 kΩ                       |                          | 4250 K±2 %          | (4300 K)            |
| ERTJ0ER223□  | 22 kΩ                       |                          | 4250 K±2 %          | (4300 K)            |
| ERTJ0EP333□  | 33 kΩ                       |                          | 4050 K±2 %          | (4100 K)            |
| ERTJ0ER333□  | 33 kΩ                       |                          | 4250 K±2 %          | (4300 K)            |
| ERTJ0ET333□  | 33 kΩ                       |                          | 4500 K±2 %          | (4580 K)            |
| ERTJ0EP473□  | 47 kΩ                       |                          | 4050 K±2 %          | (4100 K)            |
| ERTJ0ET473□  | 47 kΩ                       |                          | 4500 K±2 %          | (4550 K)            |
| ERTJ0EV473□  | 47 kΩ                       |                          | 4700 K±2 %          | (4750 K)            |
| ERTJ0EP683□  | 68 kΩ                       |                          | 4050 K±2 %          | (4100 K)            |
| ERTJ0ER683□  | 68 kΩ                       |                          | 4250 K±2 %          | (4300 K)            |
| ERTJ0EV683□  | 68 kΩ                       |                          | 4700 K±2 %          | (4750 K)            |
| ERTJ0EP104□  | 100 kΩ                      |                          | 4050 K±2 %          | (4100 K)            |
| ERTJ0ER104□  | 100 kΩ                      | 4250 K±2 %               | (4300 K)            |                     |
| ERTJ0ES104□  | 100 kΩ                      | 4330 K±2 %               | (4390 K)            |                     |
| ERTJ0ET104□  | 100 kΩ                      | 4500 K±2 %               | (4580 K)            |                     |
| ERTJ0EV104□  | 100 kΩ                      | 4700 K±2 %               | (4750 K)            |                     |
| ERTJ0ET154□  | 150 kΩ                      | 4500 K±2 %               | (4580 K)            |                     |
| ERTJ0EV154□  | 150 kΩ                      | 4700 K±2 %               | (4750 K)            |                     |
| ERTJ0EV224□  | 220 kΩ                      | 4700 K±2 %               | (4750 K)            |                     |
| ERTJ0EV334□  | 330 kΩ                      | 4700 K±2 %               | (4750 K)            |                     |
| ERTJ0EV474□  | 470 kΩ                      | 4700 K±2 %               | (4750 K)            |                     |

□ : Resistance Tolerance Code

● 0603(EIA)

| Part Number  | Nominal Resistance at 25 °C | Resistance Tolerance     | B Value at 25/50(K) | B Value at 25/85(K) |
|--------------|-----------------------------|--------------------------|---------------------|---------------------|
| ERTJ1VA220□  | 22 Ω                        | ±3 %(H)<br>or<br>±5 %(J) | 2750 K±3 %          | (2700 K)            |
| ERTJ1VA330□  | 33 Ω                        |                          | 2750 K±3 %          | (2700 K)            |
| ERTJ1VA400□  | 40 Ω                        |                          | 2800 K±3 %          | (2750 K)            |
| ERTJ1VA470□  | 47 Ω                        |                          | 2800 K±3 %          | (2750 K)            |
| ERTJ1VA680□  | 68 Ω                        |                          | 2800 K±3 %          | (2750 K)            |
| ERTJ1VA101□  | 100 Ω                       |                          | 2800 K±3 %          | (2750 K)            |
| ERTJ1VT102□  | 1.0 kΩ                      |                          | 4500 K±2 %          | (4450 K)            |
| ERTJ1VT152□  | 1.5 kΩ                      |                          | 4500 K±2 %          | (4450 K)            |
| ERTJ1VT202□  | 2.0 kΩ                      |                          | 4500 K±2 %          | (4450 K)            |
| ERTJ1VT222□  | 2.2 kΩ                      |                          | 4500 K±2 %          | (4450 K)            |
| ERTJ1VT302□  | 3.0 kΩ                      |                          | 4500 K±2 %          | (4450 K)            |
| ERTJ1VT332□  | 3.3 kΩ                      |                          | 4500 K±2 %          | (4450 K)            |
| ERTJ1VR332□  | 3.3 kΩ                      |                          | 4250 K±2 %          | (4300 K)            |
| ERTJ1VR472□  | 4.7 kΩ                      |                          | 4250 K±2 %          | (4300 K)            |
| ERTJ1VT472□  | 4.7 kΩ                      |                          | 4500 K±2 %          | (4450 K)            |
| ERTJ1VR682□  | 6.8 kΩ                      |                          | 4250 K±2 %          | (4300 K)            |
| ERTJ1VG103□A | 10 kΩ                       |                          | (3380 K)            | 3435 K±1%           |
| ERTJ1VR103□  | 10 kΩ                       |                          | 4250 K±2 %          | (4300 K)            |
| ERTJ1VR153□  | 15 kΩ                       |                          | 4250 K±2 %          | (4300 K)            |
| ERTJ1VR223□  | 22 kΩ                       |                          | 4250 K±2 %          | (4300 K)            |
| ERTJ1VR333□  | 33 kΩ                       |                          | 4250 K±2 %          | (4300 K)            |
| ERTJ1VP473□  | 47 kΩ                       |                          | 4100 K±2 %          | (4150 K)            |
| ERTJ1VR473□  | 47 kΩ                       |                          | 4250 K±2 %          | (4300 K)            |
| ERTJ1VV473□  | 47 kΩ                       |                          | 4700 K±2 %          | (4750 K)            |
| ERTJ1VR683□  | 68 kΩ                       |                          | 4250 K±2 %          | (4300 K)            |
| ERTJ1VV683□  | 68 kΩ                       |                          | 4700 K±2 %          | (4750 K)            |
| ERTJ1VS104□A | 100 kΩ                      |                          | (4330 K)            | 4390 K±1%           |
| ERTJ1VV104□  | 100 kΩ                      |                          | 4700 K±2 %          | (4750 K)            |
| ERTJ1VV154□  | 150 kΩ                      |                          | 4700 K±2 %          | (4750 K)            |
| ERTJ1VT224□  | 220 kΩ                      |                          | 4500 K±2 %          | (4580 K)            |

□ : Resistance Tolerance Code



● Temperature and Resistance value (the resistance value at 25 °C is set to 1)/ Reference values

|                    | ERTJ□□A~ |          | ERTJ□□G~ | ERTJ□□M~ | ERTJ□□P~ | ERTJ□□R~ | ERTJ0ES~ | ERTJ1VS~ | ERTJ□□T~ | ERTJ□□T~ | ERTJ□□V~ |
|--------------------|----------|----------|----------|----------|----------|----------|----------|----------|----------|----------|----------|
| B <sub>25/50</sub> | 2750 K   | 2800 K   | (3375 K) | 3900 K   | 4050 K   | 4250 K   | 4330 K   | (4330 K) | 4500 K   | 4500 K   | 4700 K   |
| B <sub>25/85</sub> | (2700 K) | (2750 K) | 3435 K   | (3970 K) | (4100 K) | (4300 K) | (4390 K) | 4390 K   | (4450 K) | (4580 K) | (4750 K) |
| T(°C)              |          |          |          |          |          |          |          |          | *1       | *2       |          |
| -40                | 13.05    | 13.28    | 20.52    | 32.11    | 33.10    | 43.10    | 45.67    | 45.53    | 63.30    | 47.07    | 59.76    |
| -35                | 10.21    | 10.40    | 15.48    | 23.29    | 24.03    | 30.45    | 32.08    | 31.99    | 42.92    | 33.31    | 41.10    |
| -30                | 8.061    | 8.214    | 11.79    | 17.08    | 17.63    | 21.76    | 22.80    | 22.74    | 29.50    | 23.80    | 28.61    |
| -25                | 6.427    | 6.547    | 9.069    | 12.65    | 13.06    | 15.73    | 16.39    | 16.35    | 20.53    | 17.16    | 20.14    |
| -20                | 5.168    | 5.261    | 7.037    | 9.465    | 9.761    | 11.48    | 11.91    | 11.89    | 14.46    | 12.49    | 14.33    |
| -15                | 4.191    | 4.261    | 5.507    | 7.147    | 7.362    | 8.466    | 8.743    | 8.727    | 10.30    | 9.159    | 10.31    |
| -10                | 3.424    | 3.476    | 4.344    | 5.444    | 5.599    | 6.300    | 6.479    | 6.469    | 7.407    | 6.772    | 7.482    |
| -5                 | 2.819    | 2.856    | 3.453    | 4.181    | 4.291    | 4.730    | 4.845    | 4.839    | 5.388    | 5.046    | 5.481    |
| 0                  | 2.336    | 2.362    | 2.764    | 3.237    | 3.312    | 3.582    | 3.654    | 3.650    | 3.966    | 3.789    | 4.050    |
| 5                  | 1.948    | 1.966    | 2.227    | 2.524    | 2.574    | 2.734    | 2.778    | 2.776    | 2.953    | 2.864    | 3.015    |
| 10                 | 1.635    | 1.646    | 1.806    | 1.981    | 2.013    | 2.102    | 2.128    | 2.126    | 2.221    | 2.179    | 2.262    |
| 15                 | 1.380    | 1.386    | 1.474    | 1.567    | 1.584    | 1.629    | 1.642    | 1.641    | 1.687    | 1.669    | 1.710    |
| 20                 | 1.171    | 1.174    | 1.211    | 1.247    | 1.255    | 1.272    | 1.277    | 1.276    | 1.293    | 1.287    | 1.303    |
| 25                 | 1        | 1        | 1        | 1        | 1        | 1        | 1        | 1        | 1        | 1        | 1        |
| 30                 | 0.8585   | 0.8565   | 0.8309   | 0.8072   | 0.8016   | 0.7921   | 0.7888   | 0.7890   | 0.7799   | 0.7823   | 0.7734   |
| 35                 | 0.7407   | 0.7372   | 0.6941   | 0.6556   | 0.6461   | 0.6315   | 0.6263   | 0.6266   | 0.6131   | 0.6158   | 0.6023   |
| 40                 | 0.6422   | 0.6376   | 0.5828   | 0.5356   | 0.5235   | 0.5067   | 0.5004   | 0.5007   | 0.4856   | 0.4876   | 0.4721   |
| 45                 | 0.5595   | 0.5541   | 0.4916   | 0.4401   | 0.4266   | 0.4090   | 0.4022   | 0.4025   | 0.3874   | 0.3884   | 0.3723   |
| 50                 | 0.4899   | 0.4836   | 0.4165   | 0.3635   | 0.3496   | 0.3319   | 0.3251   | 0.3254   | 0.3111   | 0.3111   | 0.2954   |
| 55                 | 0.4309   | 0.4238   | 0.3543   | 0.3018   | 0.2881   | 0.2709   | 0.2642   | 0.2645   | 0.2513   | 0.2504   | 0.2356   |
| 60                 | 0.3806   | 0.3730   | 0.3027   | 0.2518   | 0.2386   | 0.2222   | 0.2158   | 0.2161   | 0.2042   | 0.2026   | 0.1889   |
| 65                 | 0.3376   | 0.3295   | 0.2595   | 0.2111   | 0.1985   | 0.1832   | 0.1772   | 0.1774   | 0.1670   | 0.1648   | 0.1523   |
| 70                 | 0.3008   | 0.2922   | 0.2233   | 0.1777   | 0.1659   | 0.1518   | 0.1463   | 0.1465   | 0.1377   | 0.1348   | 0.1236   |
| 75                 | 0.2691   | 0.2600   | 0.1929   | 0.1504   | 0.1393   | 0.1264   | 0.1213   | 0.1215   | 0.1144   | 0.1108   | 0.1009   |
| 80                 | 0.2417   | 0.2322   | 0.1672   | 0.1278   | 0.1174   | 0.1057   | 0.1011   | 0.1013   | 0.09560  | 0.09162  | 0.08284  |
| 85                 | 0.2180   | 0.2081   | 0.1451   | 0.1090   | 0.09937  | 0.08873  | 0.08469  | 0.08486  | 0.08033  | 0.07609  | 0.06834  |
| 90                 | 0.1974   | 0.1871   | 0.1261   | 0.09310  | 0.08442  | 0.07468  | 0.07122  | 0.07138  | 0.06782  | 0.06345  | 0.05662  |
| 95                 | 0.1793   | 0.1688   | 0.1097   | 0.07980  | 0.07200  | 0.06307  | 0.06014  | 0.06028  | 0.05753  | 0.05314  | 0.04712  |
| 100                | 0.1636   | 0.1528   | 0.09563  | 0.06871  | 0.06166  | 0.05353  | 0.05099  | 0.05112  | 0.04903  | 0.04472  | 0.03939  |
| 105                | 0.1498   | 0.1387   | 0.08357  | 0.05947  | 0.05306  | 0.04568  | 0.04340  | 0.04351  | 0.04198  | 0.03784  | 0.03308  |
| 110                | 0.1377   | 0.1263   | 0.07317  | 0.05170  | 0.04587  | 0.03918  | 0.03708  | 0.03718  | 0.03609  | 0.03218  | 0.02791  |
| 115                | 0.1270   | 0.1153   | 0.06421  | 0.04512  | 0.03979  | 0.03374  | 0.03179  | 0.03188  | 0.03117  | 0.02748  | 0.02364  |
| 120                | 0.1175   | 0.1056   | 0.05650  | 0.03951  | 0.03460  | 0.02916  | 0.02734  | 0.02742  | 0.02702  | 0.02352  | 0.02009  |
| 125                | 0.1091   | 0.09695  | 0.04986  | 0.03470  | 0.03013  | 0.02527  | 0.02359  | 0.02367  | 0.02351  | 0.02017  | 0.01712  |

\*1 Apply to products with a B<sub>25/50</sub> constant of 4500 K and a resistance value of 25 °C less than 10 kΩ. \*2 Applied only to ERTJ0ET104□.

\*2 Apply to products with a B<sub>25/50</sub> constant of 4500 K and a resistance value of 25 °C of 10 kΩ or more. \*2 Applied only to ERTJ0ET104□.

$$B_{25/50} = \frac{\ln(R_{25}/R_{50})}{1/298.15 - 1/323.15}$$

$$B_{25/85} = \frac{\ln(R_{25}/R_{85})}{1/298.15 - 1/358.15}$$

R<sub>25</sub>=Resistance at 25.0±0.1 °C

R<sub>50</sub>=Resistance at 50.0±0.1 °C

R<sub>85</sub>=Resistance at 85.0±0.1 °C

## Specification and Test Method

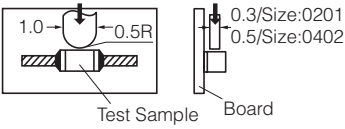
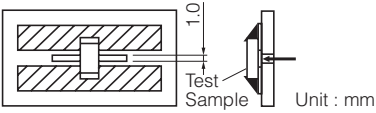
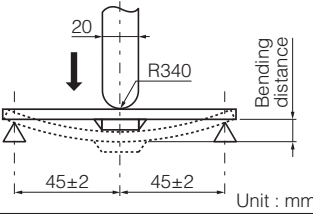
| Item   | Specification   | Test Method  |                  |                |                        |                    |              |                |                    |              |  |      |           |            |   |           |            |   |            |            |
|--|---|--|------------------|----------------|------------------------|--------------------|--------------|----------------|--------------------|--------------|--|------|-----------|------------|---|-----------|------------|---|------------|------------|
| Rated Zero-power Resistance (R <sub>25</sub> ) | Within the specified tolerance.   | The value is measured at a power that the influence of self-heat generation can be negligible (0.1mW or less), at the rated ambient temperature of 25.0±0.1°C.   |                  |                |                        |                    |              |                |                    |              |  |      |           |            |   |           |            |   |            |            |
| B Value  | Shown in each Individual Specification.<br>* Individual Specification shall specify B <sub>25/50</sub> or B <sub>25/85</sub> .  | <p>The Zero-power resistances; R<sub>1</sub> and R<sub>2</sub>, shall be measured respectively at T<sub>1</sub> (deg.C) and T<sub>2</sub> (deg.C). The B value is calculated by the following equation.</p> $B_{T_1/T_2} = \frac{\ln(R_1) - \ln(R_2)}{1/(T_1 + 273.15) - 1/(T_2 + 273.15)}$ <table border="1"> <thead> <tr> <th></th> <th>T<sub>1</sub></th> <th>T<sub>2</sub></th> </tr> </thead> <tbody> <tr> <td>B<sub>25/50</sub></td> <td>25.0 ±0.1 °C</td> <td>50.0 ±0.1 °C</td> </tr> <tr> <td>B<sub>25/85</sub></td> <td>25.0 ±0.1 °C</td> <td>85.0 ±0.1 °C</td> </tr> </tbody> </table> |                  | T <sub>1</sub> | T <sub>2</sub>         | B <sub>25/50</sub> | 25.0 ±0.1 °C | 50.0 ±0.1 °C   | B <sub>25/85</sub> | 25.0 ±0.1 °C | 85.0 ±0.1 °C   |      |           |            |   |           |            |   |            |            |
|  | T <sub>1</sub>  | T <sub>2</sub>   |                  |                |                        |                    |              |                |                    |              |  |      |           |            |   |           |            |   |            |            |
| B <sub>25/50</sub>                             | 25.0 ±0.1 °C  | 50.0 ±0.1 °C   |                  |                |                        |                    |              |                |                    |              |  |      |           |            |   |           |            |   |            |            |
| B <sub>25/85</sub>                             | 25.0 ±0.1 °C  | 85.0 ±0.1 °C   |                  |                |                        |                    |              |                |                    |              |  |      |           |            |   |           |            |   |            |            |
| Adhesion                                       | The terminal electrode shall be free from peeling or signs of peeling.  | <p>Applied force :<br/>Size 0201 : 2 N<br/>Size 0402, 0603 : 5 N<br/>Duration : 10 s</p> <p>Size : 0201, 0402</p>  <p>Size : 0603</p>   |                  |                |                        |                    |              |                |                    |              |  |      |           |            |   |           |            |   |            |            |
| Bending Strength                               | There shall be no cracks and other mechanical damage.<br>R <sub>25</sub> change : within ±5 %   | <p>Bending distance : 1 mm<br/>Bending speed : 1 mm/s</p>    |                  |                |                        |                    |              |                |                    |              |  |      |           |            |   |           |            |   |            |            |
| Resistance to Soldering Heat                   | There shall be no cracks and other mechanical damage.<br><table border="0"> <tr> <td></td> <td>Narrow Tol. type</td> <td>Standard type</td> </tr> <tr> <td>R<sub>25</sub> change</td> <td>: within ±2 %</td> <td>within ±3 %</td> </tr> <tr> <td>B Value change</td> <td>: within ±1 %</td> <td>within ±2 %</td> </tr> </table> |  | Narrow Tol. type | Standard type  | R <sub>25</sub> change | : within ±2 %      | within ±3 %  | B Value change | : within ±1 %      | within ±2 %  | <p>Soldering bath method<br/>Solder temperature : 270 ±5 °C<br/>Dipping period : 4.0 ±1 s<br/>Preheat condition :</p> <table border="1"> <thead> <tr> <th>Step</th> <th>Temp (°C)</th> <th>Period (s)</th> </tr> </thead> <tbody> <tr> <td>1</td> <td>80 to 100</td> <td>120 to 180</td> </tr> <tr> <td>2</td> <td>150 to 200</td> <td>120 to 180</td> </tr> </tbody> </table> | Step | Temp (°C) | Period (s) | 1 | 80 to 100 | 120 to 180 | 2 | 150 to 200 | 120 to 180 |
|  | Narrow Tol. type  | Standard type  |                  |                |                        |                    |              |                |                    |              |  |      |           |            |   |           |            |   |            |            |
| R <sub>25</sub> change                         | : within ±2 %   | within ±3 %  |                  |                |                        |                    |              |                |                    |              |  |      |           |            |   |           |            |   |            |            |
| B Value change                                 | : within ±1 %   | within ±2 %  |                  |                |                        |                    |              |                |                    |              |  |      |           |            |   |           |            |   |            |            |
| Step   | Temp (°C)   | Period (s)   |                  |                |                        |                    |              |                |                    |              |  |      |           |            |   |           |            |   |            |            |
| 1  | 80 to 100   | 120 to 180   |                  |                |                        |                    |              |                |                    |              |  |      |           |            |   |           |            |   |            |            |
| 2  | 150 to 200  | 120 to 180   |                  |                |                        |                    |              |                |                    |              |  |      |           |            |   |           |            |   |            |            |
| Solderability                                  | More than 95 % of the soldered area of both terminal electrodes shall be covered with fresh solder.   | <p>Soldering bath method<br/>Solder temperature : 230 ±5 °C<br/>Dipping period : 4 ±1 s<br/>Solder : Sn-3.0Ag-0.5Cu</p>  |                  |                |                        |                    |              |                |                    |              |  |      |           |            |   |           |            |   |            |            |

## Specification and Test Method

| Item                      | Specification  |   | Test Method  |
|---------------------------|--|---|--|
| Temperature Cycling       | Narrow Tol. type<br>R <sub>25</sub> change : within ±2 %<br>B Value change : within ±1 % | Standard type<br>within ±3 %<br>within ±2 % | Conditions of one cycle<br>Step 1 : -40 °C, 30±3 min<br>Step 2 : Room temp., 3 min max.<br>Step 3 : 125 °C, 30±3 min.<br>Step 4 : Room temp., 3 min max.<br>Number of cycles: 100 cycles |
| Humidity                  | Narrow Tol. type<br>R <sub>25</sub> change : within ±2 %<br>B Value change : within ±1 % | Standard type<br>within ±3 %<br>within ±2 % | Temperature : 85 ±2 °C<br>Relative humidity : 85 ±5 %<br>Test period : 1000 +48/0 h  |
| Biased Humidity           | Narrow Tol. type<br>R <sub>25</sub> change : within ±2 %<br>B Value change : within ±1 % | Standard type<br>within ±3 %<br>within ±2 % | Temperature : 85 ±2 °C<br>Relative humidity : 85 ±5 %<br>Applied power : 10 mW(D.C.)<br>Test period : 500 +48/0 h  |
| Low Temperature Exposure  | Narrow Tol. type<br>R <sub>25</sub> change : within ±2 %<br>B Value change : within ±1 % | Standard type<br>within ±3 %<br>within ±2 % | Specimens are soldered on the testing board shown in Fig.2.<br>Temperature : -40 ±3 °C<br>Test period : 1000 +48/0 h   |
| High Temperature Exposure | Narrow Tol. type<br>R <sub>25</sub> change : within ±2 %<br>B Value change : within ±1 % | Standard type<br>within ±3 %<br>within ±2 % | Specimens are soldered on the testing board shown in Fig.2.<br>Temperature : 125 ±3 °C<br>Test period : 1000 +48/0 h   |

## Typical Application

### ● Temperature Detection

Writing current control of HDD



### ● Temperature Compensation (Pseudo-linearization)

Contrast level control of LCD

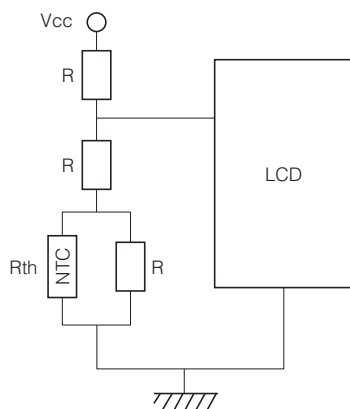

### ● Temperature Compensation (RF circuit)

Temperature compensation of TCXO



## Dimensions in mm (not to scale)



(Unit : mm)

| Size Code (EIA) | L         | W         | T         | L <sub>1</sub> , L <sub>2</sub> |
|-----------------|-----------|-----------|-----------|---------------------------------|
| Z(0201)         | 0.60±0.03 | 0.30±0.03 | 0.30±0.03 | 0.15±0.05                       |
| 0(0402)         | 1.0±0.1   | 0.50±0.05 | 0.50±0.05 | 0.25±0.15                       |
| 1(0603)         | 1.60±0.15 | 0.8±0.1   | 0.8±0.1   | 0.3±0.2                         |

## Packaging Methods

### ● Standard Packing Quantities

| Size Code | Thickness (mm) | Kind of Taping         | Pitch (mm) | Quantity (pcs./reel) |
|-----------|----------------|------------------------|------------|----------------------|
| Z(0201)   | 0.3            | Pressed Carrier Taping | 2          | 15,000               |
| 0(0402)   | 0.5            | Punched Carrier Taping | 2          | 10,000               |
| 1(0603)   | 0.8            |                        | 4          | 4,000                |

### ● Pitch 2 mm (Pressed Carrier Taping) : Size 0201

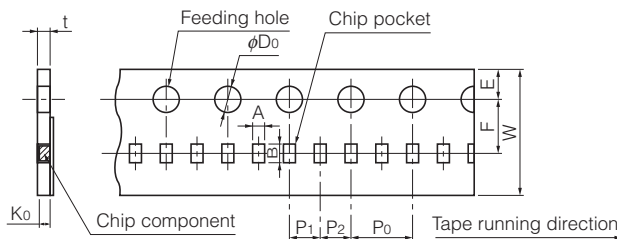

| Symbol    | A          | B          | W        | F          | E          | P <sub>1</sub> | P <sub>2</sub> | P <sub>0</sub> | φD <sub>0</sub>                  | t         | K <sub>0</sub> |
|-----------|------------|------------|----------|------------|------------|----------------|----------------|----------------|----------------------------------|-----------|----------------|
| Dim. (mm) | 0.36 ±0.03 | 0.66 ±0.03 | 8.0 ±0.2 | 3.50 ±0.05 | 1.75 ±0.10 | 2.00 ±0.05     | 2.00 ±0.05     | 4.0 ±0.1       | 1.5 <sup>+0.1</sup> <sub>0</sub> | 0.55 max. | 0.36 ±0.03     |

### ● Pitch 2 mm (Punched Carrier Taping) : Size 0402

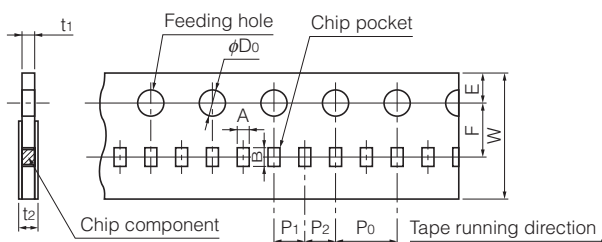

| Symbol    | A          | B          | W        | F          | E          | P <sub>1</sub> | P <sub>2</sub> | P <sub>0</sub> | φD <sub>0</sub>                  | t <sub>1</sub> | t <sub>2</sub> |
|-----------|------------|------------|----------|------------|------------|----------------|----------------|----------------|----------------------------------|----------------|----------------|
| Dim. (mm) | 0.62 ±0.05 | 1.12 ±0.05 | 8.0 ±0.2 | 3.50 ±0.05 | 1.75 ±0.10 | 2.00 ±0.05     | 2.00 ±0.05     | 4.0 ±0.1       | 1.5 <sup>+0.1</sup> <sub>0</sub> | 0.7 max.       | 1.0 max.       |

### ● Pitch 4 mm (Punched Carrier Taping) : Size 0603

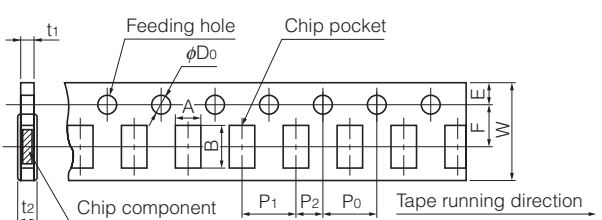

| Symbol    | A        | B        | W        | F          | E          | P <sub>1</sub> | P <sub>2</sub> | P <sub>0</sub> | φD <sub>0</sub>                  | t <sub>1</sub> | t <sub>2</sub> |
|-----------|----------|----------|----------|------------|------------|----------------|----------------|----------------|----------------------------------|----------------|----------------|
| Dim. (mm) | 1.0 ±0.1 | 1.8 ±0.1 | 8.0 ±0.2 | 3.50 ±0.05 | 1.75 ±0.10 | 4.0 ±0.1       | 2.00 ±0.05     | 4.0 ±0.1       | 1.5 <sup>+0.1</sup> <sub>0</sub> | 1.1 max.       | 1.4 max.       |

### ● Reel for Taping

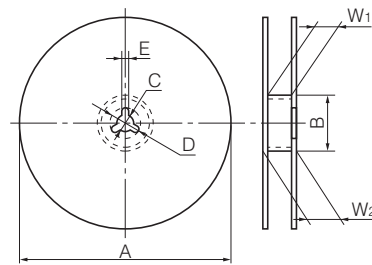

| Symbol    | φA                  | φB                                | C        | D        | E       | W <sub>1</sub>                   | W <sub>2</sub> |
|-----------|---------------------|-----------------------------------|----------|----------|---------|----------------------------------|----------------|
| Dim. (mm) | 180 <sup>-0.3</sup> | 60.0 <sup>+1.0</sup> <sub>0</sub> | 13.0±0.5 | 21.0±0.8 | 2.0±0.5 | 9.0 <sup>+1.0</sup> <sub>0</sub> | 11.4±1.0       |

### ● Leader Part and Taped End

#### Leader part

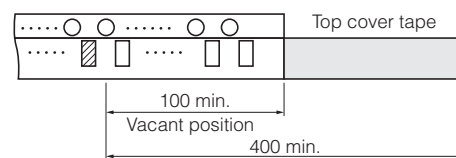

#### Taped end

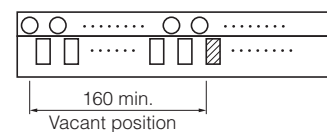

(Unit : mm)

## Minimum Quantity / Packing Unit

| Part Number (Size) | Minimum Quantity / Packing Unit | Packing Quantity in Carton | Carton L×W×H (mm) |
|--------------------|---------------------------------|----------------------------|-------------------|
| ERTJZ (0201)       | 15,000                          | 300,000                    | 250×200×200       |
| ERTJ0 (0402)       | 10,000                          | 200,000                    | 250×200×200       |
| ERTJ1 (0603)       | 4,000                           | 80,000                     | 250×200×200       |

Part No., quantity and country of origin are designated on outer packages in English.

## Multilayer NTC Thermistors

Series: ERTJ

|                             |
|-----------------------------|
| <b>Handling Precautions</b> |
|-----------------------------|

**[Precautions]**

- **Do not use the products beyond the descriptions in this product catalog.**
- **This product catalog guarantees the quality of the products as individual components. Before you use the products, please make sure to check and evaluate the products in the circumstance where they are installed in your product.**

**! Safety Precautions**

Multilayer NTC Thermistors for General Applications (hereafter referred to as “Thermistors”) are intended to be used in general-purpose applications as measures against Temperature detection and Temperature compensation in consumer electronics (audio/visual, home, office, information & communication) equipment. When subjected to severe electrical, environmental, and/or mechanical stress beyond the specifications, as noted in the Ratings and Specified Conditions section, the Thermistors’ performance may be degraded, or become failure mode, such as short circuit mode and open-circuit mode.

If you use under the condition of short-circuit, heat generation of Thermistors will occur by running large current due to application of voltage. There are possibilities of smoke emission, substrate burn-out, and, in the worst case, fire. For products which require high safety levels, please carefully consider how a single malfunction can affect your product. In order to ensure the safety in the case of a single malfunction, please design products with fail-safe, such as setting up protecting circuits, etc.

We are trying to improve the quality and the reliability, but the durability differs depending on the use environment and the use conditions. On use, be sure to confirm the actual product under the actual use conditions.

- For the following applications and conditions, please be sure to consult with our sales representative in advance and to exchange product specifications which conform to such applications.
    - When your application may have difficulty complying with the safety or handling precautions specified below.
    - High-quality and high-reliability required devices that have possibility of causing hazardous conditions, such as death or injury (regardless of directly or indirectly), due to failure or malfunction of the product.
- ① Aircraft and Aerospace Equipment (artificial satellite, rocket, etc.)
  - ② Submarine Equipment (submarine repeating equipment, etc.)
  - ③ Transportation Equipment (motor vehicles, airplanes, trains, ship, traffic signal controllers, etc.)
  - ④ Power Generation Control Equipment  
(atomic power, hydroelectric power, thermal power plant control system, etc.)
  - ⑤ Medical Equipment (life-support equipment, pacemakers, dialysis controllers, etc.)
  - ⑥ Information Processing Equipment (large scale computer systems, etc.)
  - ⑦ Electric Heating Appliances, Combustion devices (gas fan heaters, oil fan heaters, etc.)
  - ⑧ Rotary Motion Equipment
  - ⑨ Security Systems
  - ⑩ And any similar types of equipment

**! Strict Observance****1. Confirmation of Rated Performance**

The Thermistors shall be operated within the specified rating/performance.

Applications exceeding the specifications may cause deteriorated performance and/or breakdown, resulting in degradation and/or smoking or ignition of products. The following are strictly observed.

- (1) The Thermistors shall not be operated beyond the specified operating temperature range.
- (2) The Thermistors shall not be operated in excess of the specified maximum power dissipation.

**2. The Thermistors shall not be mounted near flammables.**



## Operating Conditions and Circuit Design

### 1. Circuit Design

#### 1.1 Operating Temperature and Storage Temperature

When operating a components-mounted circuit, please be sure to observe the "Operating Temperature Range", written in delivery specifications. Storage temperature of PCB after mounting Thermistors, which is not operated, should be within the specified "Storage Temperature Range" in the delivery specifications. Please remember not to use the product under the condition that exceeds the specified maximum temperature.

#### 1.2 Operating Power

The electricity applied to between terminals of Thermistors should be under the specified maximum power dissipation. There are possibilities of breakage and burn-out due to excessive self-heating of Thermistors, if the power exceeds maximum power dissipation when operating. Please consider installing protection circuit for your circuit to improve the safety, in case of abnormal voltage application and so on. Thermistors' performance of temperature detection would be deteriorated if self-heating occurs, even when you use it under the maximum power dissipation. Please consider the maximum power dissipation and dissipation factor.

#### 【Maximum power dissipation】

- The Maximum power that can be continuously applied under static air at a certain ambient temperature. The Maximum power dissipation under an ambient temperature of 25 °C or less is the same with the rated maximum power dissipation, and Maximum power dissipation beyond 25 °C depends on the Decreased power dissipation curve below.

#### 【Dissipation factor】

- The constant amount power required to raise the temperature of the Thermistor 1 °C through self heat generation under stable temperatures.  
Dissipation factor (mW/°C) = Power consumption of Thermistor / Temperature rise of element.



#### 1.3 Environmental Restrictions

The Thermistors does not take the use under the following special environments into consideration. Accordingly, the use in the following special environments, and such environmental conditions may affect the performance of the product; prior to use, verify the performance, reliability, etc. thoroughly.

- ① Use in liquids such as water, oil, chemical, and organic solvent.
- ② Use under direct sunlight, in outdoor or in dusty atmospheres.
- ③ Use in places full of corrosive gases such as sea breeze, Cl<sub>2</sub>, H<sub>2</sub>S, NH<sub>3</sub>, SO<sub>2</sub>, and NO<sub>x</sub>.
- ④ Use in environment with large static electricity or strong electromagnetic waves or strong radial ray.
- ⑤ Where the product is close to a heating component, or where an inflammable such as a polyvinyl chloride wire is arranged close to the product.
- ⑥ Where this product is sealed or coated with resin etc.
- ⑦ Where solvent, water, or water-soluble detergent is used in flux cleaning after soldering.  
(Pay particular attention to water-soluble flux.)
- ⑧ Use in such a place where the product is wetted due to dew condensation.
- ⑨ Use the product in a contaminated state.  
Ex.) Do not handle the product such as sticking sebum directly by touching the product after mounting printed circuit board.
- ⑩ Under severe conditions of vibration or impact beyond the specified conditions found in the Specifications.

#### 1.4 Measurement of Resistance

The resistance of the Thermistors varies depending on ambient temperatures and self-heating. To measure the resistance value when examining circuit configuration and conducting receiving inspection and so on, the following points should be taken into consideration:

- ① Measurement temp : 25±0.1 °C  
Measurement in liquid (silicon oil, etc.) is recommended for a stable measurement temperature.
- ② Power : 0.10 mW max. 4 terminal measurement with a constant-current power supply is recommended.

**2. Design of Printed Circuit Board**

**2.1 Selection of Printed Circuit Boards**

There is a possibility of performance deterioration by heat shock (temperature cycles), which causes cracks, from alumina substrate. Please confirm that the substrate you use does not deteriorate the Thermistors' quality.

**2.2 Design of Land Pattern**

(1) Recommended land dimensions are shown below. Use the proper amount of solder in order to prevent cracking. Using too much solder places excessive stress on the Thermistors..

Recommended Land Dimensions(Ex.)

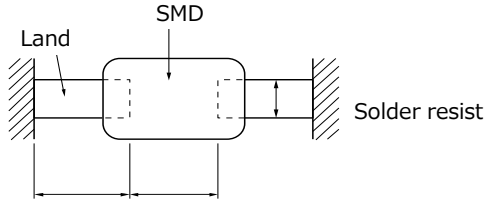

| Size Code/EIA | Component dimensions |     |     | Unit (mm)  |              |            |
|---------------|----------------------|-----|-----|------------|--------------|------------|
|               | L                    | W   | T   | a          | b            | c          |
| Z(0201)       | 0.6                  | 0.3 | 0.3 | 0.2 to 0.3 | 0.25 to 0.30 | 0.2 to 0.3 |
| 0(0402)       | 1.0                  | 0.5 | 0.5 | 0.4 to 0.5 | 0.4 to 0.5   | 0.4 to 0.5 |
| 1(0603)       | 1.6                  | 0.8 | 0.8 | 0.8 to 1.0 | 0.6 to 0.8   | 0.6 to 0.8 |

(2) The land size shall be designed to have equal space, on both right and left side. If the amount of solder on both sides is not equal, the component may be cracked by stress since the side with a larger amount of solder solidifies later during cooling.

**Recommended Amount of Solder**

(a) Excessive amount    (b) Proper amount    (c) Insufficient amount



**2.3 Utilization of Solder Resist**

(1) Solder resist shall be utilized to equalize the amounts of solder on both sides.

- (2) Solder resist shall be used to divide the pattern for the following cases;
- Components are arranged closely.
  - The Thermistor is mounted near a component with lead wires.
  - The Thermistor is placed near a chassis.

Refer to the table below.

**Prohibited Applications and Recommended Applications**

| Item  | Prohibited applications  | Improved applications by pattern division |
|---|--|---|
| Mixed mounting with a component with lead wires | The lead wire of a Component With lead wires<br>                   | Solder resist<br>                         |
| Arrangement near chassis                        | Chassis<br>Solder(ground solder)<br>Electrode pattern<br>          | Solder resist<br>                         |
| Retro-fitting of component with lead wires      | A lead wire of Retrofitted component<br>Soldering iron<br>iron<br> | Solder resist<br>                         |
| Lateral arrangement                             | Portion to be Excessively soldered<br>Land<br>                     | Solder resist<br>                         |

**2.4 Component Layout**

To prevent the crack of Thermistors, try to place it on the position that could not easily be affected by the bending stress of substrate while mounting procedures or procedures afterwards. Placement of the Thermistors near heating elements also requires the great care to be taken in order to avoid stresses from rapid heating and cooling.

- (1) To minimize mechanical stress caused by the warp or bending of a PC board, please follow the recommended Thermistors' layout below.

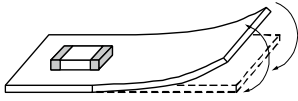
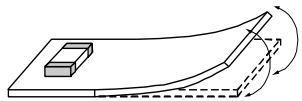
| Prohibited layout  | Recommended layout  |
|--|---|
|  |  |
|  | <p>Layout the Varistors sideways against the stressing direction.</p>               |

- (2) The following layout is for your reference since mechanical stress near the dividing/breaking position of a PC board varies depending on the mounting position of the Thermistors.

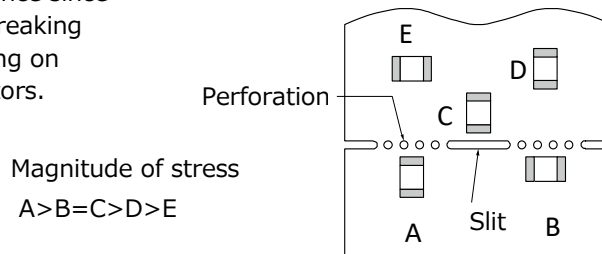

- (3) The magnitude of mechanical stress applied to the Thermistors when dividing the circuit board in descending order is as follows: push back < slit < V-groove < perforation. Also take into account the layout of the Thermistors and the dividing/breaking method.
- (4) When the Thermistors are placed near heating elements such as heater, etc., cracks from thermal stresses may occur under following situation:
- Soldering the Thermistors directly to heating elements.
  - Sharing the land with heating elements.
- If planning to conduct above-mentioned mounting and/or placement, please contact us in advance.

## 2.5 Mounting Density and Spaces

Intervals between components should not be too narrow to prevent the influence from solder bridges and solder balls. The space between components should be carefully determined.

## Precautions for Assembly

### 1. Storage

- (1) The Thermistors shall be stored between 5 to 40 °C and 20 to 70 % RH, not under severe conditions of high temperature and humidity.
- (2) If stored in a place where humidity, dust, or corrosive gasses (hydrogen sulfide, sulfurous acid, hydrogen chloride and ammonia, etc.) are contained, the solderability of terminals electrodes will be deteriorated. In addition, storage in a place where the heat or direct sunlight exposure occurs will causes or direct sunlight exposure occurs will causes mounting problems due to deformation of tapes and reels and components and taping/reels sticking together.
- (3) Do not store components longer than 6 months. Check the solderability of products that have been stored for more than 6 months before use.

### 2. Chip Mounting Consideration

- (1) When mounting the Thermistors/components on a PC board, the Thermistor bodies shall be free from excessive impact loads such as mechanical impact or stress due to the positioning, pushing force and displacement of vacuum nozzles during mounting.
- (2) Maintenance and inspection of the Chip Mounter must be performed regularly.
- (3) If the bottom dead center of the vacuum nozzle is too low, the Thermistor will crack from excessive force during mounting. The following precautions and recommendations are for your reference in use.
  - (a) Set and adjust the bottom dead center of the vacuum nozzles to the upper surface of the PC board after correcting the warp of the PC board.
  - (b) Set the pushing force of the vacuum nozzle during mounting to 1 to 3 N in static load.
  - (c) For double surface mounting, apply a supporting pin on the rear surface of the PC board to suppress the bending of the PC board in order to minimize the impact of the vacuum nozzles. Typical examples are shown in the table below.
  - (d) Adjust the vacuum nozzles so that their bottom dead center during mounting is not too low.

| Item                    | Prohibited mounting   | Recommended mounting  |
|-------------------------|---|---|
| Single surface mounting |  Crack                         |  Supporting pin<br>The supporting pin does not necessarily have to be positioned |
| Double surface mounting |  Separation of solder<br>Crack |  Supporting pin  |

- (4) The closing dimensions of the positioning chucks shall be controlled. Maintenance and replacement of positioning chucks shall be performed regularly to prevent chipping or cracking of the Thermistors caused by mechanical impact during positioning due to worn positioning chucks.
- (5) Maximum stroke of the nozzle shall be adjusted so that the maximum bending of PC board does not exceed 0.5 mm at 90 mm span. The PC board shall be supported by an adequate number of supporting pins.

### 3. Selection of Soldering Flux

Soldering flux may seriously affect the performance of the Thermistors. The following shall be confirmed before use.

- (1) The soldering flux should have a halogen based content of 0.1 wt% (converted to chlorine) or below. Do not use soldering flux with strong acid.
- (2) When applying water-soluble soldering flux, wash the Thermistors sufficiently because the soldering flux residue on the surface of PC boards may deteriorate the insulation resistance on the Thermistors' surface.

### 4. Soldering

#### 4.1 Reflow Soldering

The reflow soldering temperature conditions are composed of temperature curves of Preheating, Temp. rise, Heating, Peak and Gradual cooling. Large temperature difference inside the Thermistors caused by rapid heat application to the Thermistors may lead to excessive thermal stresses, contributing to the thermal cracks. The Preheating temperature requires controlling with great care so that tombstone phenomenon may be prevented.

Recommended profile of Reflow Soldering (Ex.)



| Item              | Temperature                   | Period or Speed |
|-------------------|-------------------------------|-----------------|
| ① Preheating      | 140 to 180 °C                 | 60 to 120 s     |
| ② Temp. rise      | Preheating temp to Peak temp. | 2 to 5 °C / s   |
| ③ Heating         | 220 °C min.                   | 60 s max.       |
| ④ Peak            | 260 °C max.                   | 10 s max.       |
| ⑤ Gradual cooling | Peak temp. to 140 °C          | 1 to 4 °C / s   |

$\Delta T$  : Allowable temperature difference  $\Delta T \leq 150$  °C

The rapid cooling (forced cooling) during Gradual cooling part should be avoided, because this may cause defects such as the thermal cracks, etc. When the Thermistors are immersed into a cleaning solvent, make sure that the surface temperatures of the devices do not exceed 100 °C. Performing reflow soldering twice under the conditions shown in the figure above [Recommended profile of Flow soldering (Ex.)] will not cause any problems. However, pay attention to the possible warp and bending of the PC board.

Recommended soldering condition is for the guideline for ensuring the basic characteristics of the components, not for the stable soldering conditions. Conditions for proper soldering should be set up according to individual conditions. The temperature of this product at the time of mounting changes depending on mounting conditions, therefore, please confirm that Product surface becomes the specified temperature when mounting it on the end product.

## 4.2 Hand Soldering

Hand soldering typically causes significant temperature change, which may induce excessive thermal stresses inside the Thermistors, resulting in the thermal cracks, etc. In order to prevent any defects, the following should be observed.

- The temperature of the soldering tips should be controlled with special care.
- The direct contact of soldering tips with the Thermistors and/or terminal electrodes should be avoided.
- Dismounted Thermistors shall not be reused.

### (1) Condition 1 (with preheating)

- Soldering : Use thread solder ( $\phi$  1.0 mm or below) which contains flux with low chlorine, developed for precision electronic equipment.
- Preheating : Conduct sufficient pre-heating, and make sure that the temperature difference between solder and Thermistors' surface is 150 °C or less.
- Temperature of Iron tip: 300 °C max.  
(The required amount of solder shall be melted in advance on the soldering tip.)
- Gradual cooling : After soldering, the Thermistors shall be cooled gradually at room temperature.

Recommended profile of Hand soldering (Ex.)

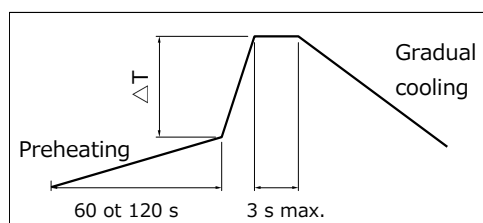

$\Delta T$  : Allowable temperature difference  $\Delta T \leq 150$  °C

### (2) Condition 2 (without preheating)

Hand soldering can be performed without preheating, by following the conditions below:

- Soldering iron tip shall never directly touch the ceramic and terminal electrodes of the Thermistors.
- The lands are sufficiently preheated with a soldering iron tip before sliding the soldering iron tip to the terminal electrodes of the Thermistors for soldering.

Conditions of Hand soldering without preheating

| Item                                 | Condition        |
|--------------------------------------|------------------|
| Temperature of Iron tip              | 270 °C max.      |
| Wattage                              | 20 W max.        |
| Shape of Iron tip                    | $\phi$ 3 mm max. |
| Soldering time with a soldering iron | 3 s max.         |

## 5. Post Soldering Cleaning

### 5.1 Cleaning solvent

Soldering flux residue may remain on the PC board if cleaned with an inappropriate solvent. This may deteriorate the electrical characteristics and reliability of the Thermistors.

### 5.2 Cleaning conditions

Inappropriate cleaning conditions such as insufficient cleaning or excessive cleaning may impair the electrical characteristics and reliability of the Thermistors.

#### (1) Insufficient cleaning can lead to :

- The halogen substance found in the residue of the soldering flux may cause the metal of terminal electrodes to corrode.
- The halogen substance found in the residue of the soldering flux on the surface of the Thermistors may change resistance values.
- Water-soluble soldering flux may have more remarkable tendencies of (a) and (b) above compared to those of rosin soldering flux.

#### (2) Excessive cleaning can lead to :

- When using ultrasonic cleaner, make sure that the output is not too large, so that the substrate will not resonate. The resonance causes the cracks in Thermistors and/or solders, and deteriorates the strength of the terminal electrodes. Please follow these conditions for Ultrasonic cleaning:  
Ultrasonic wave output : 20 W/L max.  
Ultrasonic wave frequency : 40 kHz max.  
Ultrasonic wave cleaning time : 5 min. max.



**5.3 Contamination of Cleaning solvent**

Cleaning with contaminated cleaning solvent may cause the same results as that of insufficient cleaning due to the high density of liberated halogen.

**6. Inspection Process**

The pressure from measuring terminal pins might bend the PCB when implementing circuit inspection after mounting Thermistors on PCB, and as a result, cracking may occur.

- (1) Mounted PC boards shall be supported by an adequate number of supporting pins on the back with bend settings of 90 mm span 0.5 mm max.
- (2) Confirm that the measuring pins have the right tip shape, are equal in height, have the right pressure and are set in the correct positions. The following figures are for your reference to avoid bending the PC board.

| Item                | Prohibited mounting   | Recommended mounting  |
|---------------------|---|---|
| Bending of PC board |  <p>Separated, Crack</p> |  <p>Supporting pin</p> |

**7. Protective Coating**

Make sure characteristics and reliability when using the resin coating or resin embedding for the purpose of improvement of humidity resistance or gas resistance, or fixing of parts because failures of a thermistors such as 1) ,2) and 3) may be occurred.

- (1) The solvent which contained in the resin permeate into the Thermistors, and it may deteriorate the characteristic.
- (2) When hardening the resin, chemical reaction heat (curing heat generation) happen and it may occurs the infection to the Thermistors.
- (3) The lead wire might be cut down and the soldering crack might be happen by expansion or contraction of resin hardening.

**8. Dividing/Breaking of PC Boards**

- (1) Please be careful not to stress the substrate with bending/twisting when dividing, after mounting components including Thermistors. Abnormal and excessive mechanical stress such as bending or torsion shown below can cause cracking in the Thermistors.

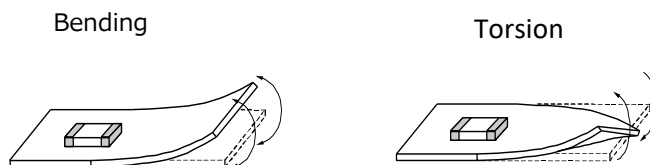

- (2) Dividing/Breaking of the PC boards shall be done carefully at moderate speed by using a jig or apparatus to prevent the Thermistors on the boards from mechanical damage.
- (3) Examples of PCB dividing/breaking jigs: The outline of PC board breaking jig is shown below. When PC board are broken or divided, loading points should be close to the jig to minimize the extent of the bending. Also, planes with no parts mounted on should be used as plane of loading, in order to prevent tensile stress induced by the bending, which may cause cracks of the Thermistors or other parts mounted on the PC boards.

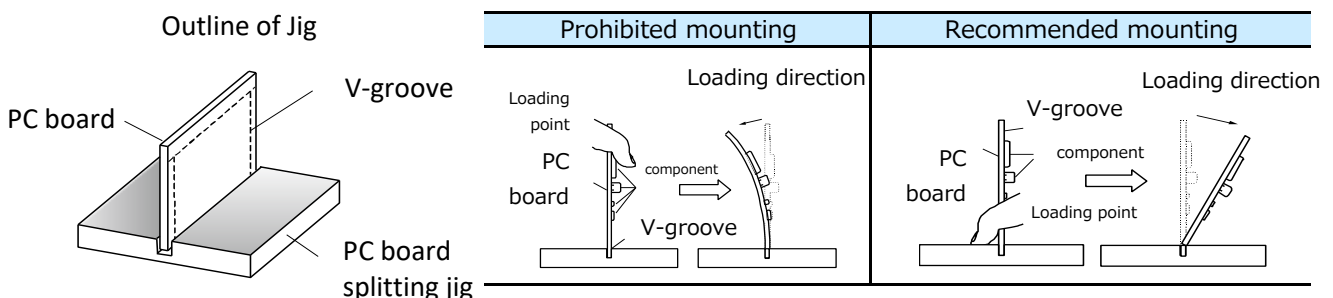

## 10. Mechanical Impact

- (1) The Thermistors shall be free from any excessive mechanical impact.

The Thermistor body is made of ceramics and may be damaged or cracked if dropped. Never use a Thermistor which has been dropped; their quality may already be impaired, and in that case, failure rate will increase.

- (2) When handling PC boards with Thermistors mounted on them, do not allow the Thermistors to collide with another PC board.

When mounted PC boards are handled or stored in a stacked state, the corner of a PC board might strike Thermistors, and the impact of the strike may cause damage or cracking and can deteriorate the withstand voltage and insulation resistance of the Thermistors.



- 11.** Do not reuse this product after removal from the mounting board.

## Precautions for discarding

As to the disposal of the Thermistors, check the method of disposal in each country or region where the modules are incorporated in your products to be used.

## Other

The Thermistors precautions described above are typical. For special mounting conditions, please contact us. The technical information in this catalog provides example of our products' typical operations and application circuit.

## Applicable laws and regulations , others

1. This product not been manufactured with any ozone depleting chemical controlled under the Montreal Protocol.
2. This product comply with RoHS(Restriction of the use of certain Hazardous Substance in electrical and electronic equipment) (DIRECTIVE 2011/65/EU and 2015/863/EU).
3. All the materials used in this part are registered material under the Law Concerning the Examination and Regulation of Manufacture, etc. of Chemical Substance.
4. If you need the notice by letter of "A preliminary judgement on the Laws of Japan foreign exchange and Foreign Trade Control", be sure to let us know.
5. These products are not dangerous goods on the transportation as identified by UN (United nations) numbers or UN classification.
6. The technical information in this catalog provides example of our products' typical operations and application circuit. We do not guarantee the non-infringement of third party's intellectual property rights and we do not grant any license, Right or interest in our intellectual property.

## Multilayer NTC Thermistors (Automotive Grade)

Series: **ERTJ-M**



### Features

- Surface Mount Device (0402, 0603)
- Highly reliable multilayer / monolithic structure
- Wide temperature operating range (-40 to 150 °C)
- Environmentally-friendly lead-free
- AEC-Q200 qualified
- RoHS compliant

### Recommended Applications

- For car audio system
- For ECUs
- For electric pumps and compressors
- For LED lights
- For batteries
- For temperature detection of various circuits

### Explanation of Part Numbers



### Construction



| No. | Name                    |                        |
|-----|-------------------------|------------------------|
| ①   | Semiconductive Ceramics |                        |
| ②   | Internal electrode      |                        |
| ③   | Terminal electrode      | Substrate electrode    |
| ④   |                         | Intermediate electrode |
| ⑤   |                         | External electrode     |

## Ratings

|                                   |                       |                       |
|-----------------------------------|-----------------------|-----------------------|
| Size code (EIA)                   | 0(0402)               | 1(0603)               |
| Operating Temperature Range       | -40 to 150 °C         |                       |
| Rated Maximum Power Dissipation*1 | 66 mW                 | 100 mW                |
| Dissipation Factor*2              | Approximately 2 mW/°C | Approximately 3 mW/°C |

- \*1 Rated Maximum Power Dissipation : The maximum power that can be continuously applied at the rated ambient temperature.  
 · The maximum value of power, and rated power is same under the condition of ambient temperature 25 °C or less. If the temperature exceeds 25 °C, rated power depends on the decreased power dissipation curve.  
 · Please see "Operating Power" for details.
- \*2 Dissipation factor : The constant amount power required to raise the temperature of the Thermistor 1 °C through self heat generation under stable temperatures.  
 · Dissipation factor is the reference value when mounted on a glass epoxy board (1.6 mmT).

## Part Number List

### ● 0402(EIA)

| Part Number  | Nominal Resistance at 25 °C | B Value at 25/50(K) | B Value at 25/85(K) |
|--------------|-----------------------------|---------------------|---------------------|
| ERTJ0EG202GM | 2 kΩ±2 %                    | (3380 K)            | 3410 K±0.5 %        |
| ERTJ0EG202HM | 2 kΩ±3 %                    | (3380 K)            | 3410 K±0.5 %        |
| ERTJ0EG202JM | 2 kΩ±5 %                    | (3380 K)            | 3410 K±0.5 %        |
| ERTJ0EG103□M | 10 kΩ                       | 3380 K±1 %          | 3435 K±1 %          |
| ERTJ0EP473□M | 47 kΩ                       | 4050 K±1 %          | (4100 K)            |
| ERTJ0ER104□M | 100 kΩ                      | 4250 K±1 %          | (4300 K)            |
| ERTJ0ET104□M | 100 kΩ                      | 4485 K±1 %          | (4550 K)            |
| ERTJ0EV104□M | 100 kΩ                      | 4700 K±1 %          | (4750 K)            |
| ERTJ0EV474□M | 470 kΩ                      | 4700 K±1 %          | (4750 K)            |

□ : Resistance Tolerance Code (F : ±1%, G : ±2%, H : ±3%, J : ±5%)

### ● 0603(EIA)

| Part Number  | Nominal Resistance at 25 °C | B Value at 25/50(K) | B Value at 25/85(K) |
|--------------|-----------------------------|---------------------|---------------------|
| ERTJ1VK102□M | 1 kΩ                        | 3650 K±1 %          | (3690 K)            |
| ERTJ1VG103□M | 10 kΩ                       | 3380 K±1 %          | 3435 K±1 %          |
| ERTJ1VP473□M | 47 kΩ                       | 4100 K±1 %          | (4150 K)            |
| ERTJ1VR104□M | 100 kΩ                      | 4200 K±1 %          | (4250 K)            |
| ERTJ1VV104□M | 100 kΩ                      | 4700 K±1 %          | (4750 K)            |
| ERTJ1VT224□M | 220 kΩ                      | 4485 K±1 %          | (4550 K)            |

□ : Resistance Tolerance Code (F : ±1%, G : ±2%, H : ±3%, J : ±5%)

### ● Temperature and Resistance value (the resistance value at 25 °C is set to 1)/ Reference values

|                    | ERTJ□□G to | ERTJ1VK to | ERTJ0EP to | ERTJ1VP to | ERTJ0ER to | ERTJ1VR to | ERTJ□□T to | ERTJ□□V to |
|--------------------|------------|------------|------------|------------|------------|------------|------------|------------|
| B <sub>25/50</sub> | (3380 K)   | 3650 K     | 4050 K     | 4100 K     | 4250 K     | 4200 K     | 4485 K     | 4700 K     |
| B <sub>25/85</sub> | 3435 K     | (3690 K)   | (4100 K)   | (4150 K)   | (4300 K)   | (4250 K)   | (4550 K)   | (4750 K)   |
| T(°C)              |            |            |            |            |            |            |            |            |
| -40                | 20.52      | 25.77      | 33.10      | 34.56      | 42.40      | 40.49      | 46.47      | 59.76      |
| -35                | 15.48      | 19.10      | 24.03      | 24.99      | 29.96      | 28.81      | 32.92      | 41.10      |
| -30                | 11.79      | 14.29      | 17.63      | 18.26      | 21.42      | 20.72      | 23.55      | 28.61      |
| -25                | 9.069      | 10.79      | 13.06      | 13.48      | 15.50      | 15.07      | 17.00      | 20.14      |
| -20                | 7.037      | 8.221      | 9.761      | 10.04      | 11.33      | 11.06      | 12.38      | 14.33      |
| -15                | 5.507      | 6.312      | 7.362      | 7.546      | 8.370      | 8.198      | 9.091      | 10.31      |
| -10                | 4.344      | 4.883      | 5.599      | 5.720      | 6.244      | 6.129      | 6.729      | 7.482      |
| -5                 | 3.453      | 3.808      | 4.291      | 4.369      | 4.699      | 4.622      | 5.019      | 5.481      |
| 0                  | 2.764      | 2.993      | 3.312      | 3.362      | 3.565      | 3.515      | 3.772      | 4.050      |
| 5                  | 2.227      | 2.372      | 2.574      | 2.604      | 2.725      | 2.694      | 2.854      | 3.015      |
| 10                 | 1.806      | 1.892      | 2.013      | 2.030      | 2.098      | 2.080      | 2.173      | 2.262      |
| 15                 | 1.474      | 1.520      | 1.584      | 1.593      | 1.627      | 1.618      | 1.666      | 1.710      |
| 20                 | 1.211      | 1.229      | 1.255      | 1.258      | 1.271      | 1.267      | 1.286      | 1.303      |
| 25                 | 1          | 1          | 1          | 1          | 1          | 1          | 1          | 1          |
| 30                 | 0.8309     | 0.8185     | 0.8016     | 0.7994     | 0.7923     | 0.7944     | 0.7829     | 0.7734     |
| 35                 | 0.6941     | 0.6738     | 0.6461     | 0.6426     | 0.6318     | 0.6350     | 0.6168     | 0.6023     |
| 40                 | 0.5828     | 0.5576     | 0.5235     | 0.5194     | 0.5069     | 0.5108     | 0.4888     | 0.4721     |
| 45                 | 0.4916     | 0.4639     | 0.4266     | 0.4222     | 0.4090     | 0.4132     | 0.3896     | 0.3723     |
| 50                 | 0.4165     | 0.3879     | 0.3496     | 0.3451     | 0.3320     | 0.3363     | 0.3123     | 0.2954     |
| 55                 | 0.3543     | 0.3258     | 0.2881     | 0.2837     | 0.2709     | 0.2752     | 0.2516     | 0.2356     |
| 60                 | 0.3027     | 0.2749     | 0.2386     | 0.2344     | 0.2222     | 0.2263     | 0.2037     | 0.1889     |
| 65                 | 0.2595     | 0.2330     | 0.1985     | 0.1946     | 0.1831     | 0.1871     | 0.1658     | 0.1523     |
| 70                 | 0.2233     | 0.1984     | 0.1659     | 0.1623     | 0.1516     | 0.1554     | 0.1357     | 0.1236     |
| 75                 | 0.1929     | 0.1696     | 0.1393     | 0.1359     | 0.1261     | 0.1297     | 0.1117     | 0.1009     |
| 80                 | 0.1672     | 0.1456     | 0.1174     | 0.1143     | 0.1054     | 0.1087     | 0.09236    | 0.08284    |
| 85                 | 0.1451     | 0.1255     | 0.09937    | 0.09658    | 0.08843    | 0.09153    | 0.07675    | 0.06834    |
| 90                 | 0.1261     | 0.1087     | 0.08442    | 0.08189    | 0.07457    | 0.07738    | 0.06404    | 0.05662    |
| 95                 | 0.1097     | 0.09440    | 0.07200    | 0.06969    | 0.06316    | 0.06567    | 0.05366    | 0.04712    |
| 100                | 0.09563    | 0.08229    | 0.06166    | 0.05957    | 0.05371    | 0.05596    | 0.04518    | 0.03939    |
| 105                | 0.08357    | 0.07195    | 0.05306    | 0.05117    | 0.04585    | 0.04786    | 0.03825    | 0.03308    |
| 110                | 0.07317    | 0.06311    | 0.04587    | 0.04415    | 0.03929    | 0.04108    | 0.03255    | 0.02791    |
| 115                | 0.06421    | 0.05552    | 0.03979    | 0.03823    | 0.03378    | 0.03539    | 0.02781    | 0.02364    |
| 120                | 0.05650    | 0.04899    | 0.03460    | 0.03319    | 0.02913    | 0.03059    | 0.02382    | 0.02009    |
| 125                | 0.04986    | 0.04336    | 0.03013    | 0.02886    | 0.02519    | 0.02652    | 0.02043    | 0.01712    |
| 130                | 0.04413    | 0.03849    | 0.02629    | 0.02513    | 0.02184    | 0.02307    | 0.01755    | 0.01464    |
| 135                | 0.03916    | 0.03426    | 0.02298    | 0.02193    | 0.01898    | 0.02013    | 0.01511    | 0.01256    |
| 140                | 0.03483    | 0.03058    | 0.02013    | 0.01918    | 0.01654    | 0.01762    | 0.01304    | 0.01080    |
| 145                | 0.03105    | 0.02736    | 0.01767    | 0.01680    | 0.01445    | 0.01546    | 0.01127    | 0.00931    |
| 150                | 0.02774    | 0.02454    | 0.01553    | 0.01476    | 0.01265    | 0.01361    | 0.00976    | 0.00806    |

$$B_{25/50} = \frac{\ln(R_{25}/R_{50})}{1/298.15 - 1/323.15}$$

$$B_{25/85} = \frac{\ln(R_{25}/R_{85})}{1/298.15 - 1/358.15}$$

R<sub>25</sub>=Resistance at 25.0±0.1 °C  
 R<sub>50</sub>=Resistance at 50.0±0.1 °C  
 R<sub>85</sub>=Resistance at 85.0±0.1 °C

## Specification and Test Method

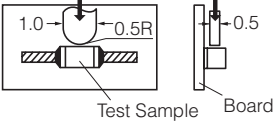
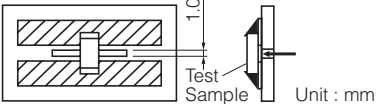
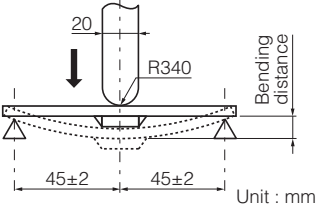
| Item   | Specification  | Test Method  |  |                |                |                    |              |              |                    |              |              |
|--|--|--|--|----------------|----------------|--------------------|--------------|--------------|--------------------|--------------|--------------|
| Rated Zero-power Resistance (R <sub>25</sub> ) | Within the specified tolerance.  | The value is measured at a power that the influence of self-heat generation can be negligible (0.1mW or less), at the rated ambient temperature of 25.0±0.1°C.   |  |                |                |                    |              |              |                    |              |              |
| B Value  | Shown in each Individual Specification.<br>* Individual Specification shall specify B <sub>25/50</sub> or B <sub>25/85</sub> . | <p>The Zero-power resistances; R<sub>1</sub> and R<sub>2</sub>, shall be measured respectively at T<sub>1</sub> (deg.C) and T<sub>2</sub> (deg.C). The B value is calculated by the following equation.</p> $B_{T_1/T_2} = \frac{\ln(R_1) - \ln(R_2)}{1/(T_1 + 273.15) - 1/(T_2 + 273.15)}$ <table border="1"> <thead> <tr> <th></th> <th>T<sub>1</sub></th> <th>T<sub>2</sub></th> </tr> </thead> <tbody> <tr> <td>B<sub>25/50</sub></td> <td>25.0 ±0.1 °C</td> <td>50.0 ±0.1 °C</td> </tr> <tr> <td>B<sub>25/85</sub></td> <td>25.0 ±0.1 °C</td> <td>85.0 ±0.1 °C</td> </tr> </tbody> </table> |  | T <sub>1</sub> | T <sub>2</sub> | B <sub>25/50</sub> | 25.0 ±0.1 °C | 50.0 ±0.1 °C | B <sub>25/85</sub> | 25.0 ±0.1 °C | 85.0 ±0.1 °C |
|  | T <sub>1</sub>   | T <sub>2</sub>   |  |                |                |                    |              |              |                    |              |              |
| B <sub>25/50</sub>                             | 25.0 ±0.1 °C   | 50.0 ±0.1 °C   |  |                |                |                    |              |              |                    |              |              |
| B <sub>25/85</sub>                             | 25.0 ±0.1 °C   | 85.0 ±0.1 °C   |  |                |                |                    |              |              |                    |              |              |
| Adhesion                                       | The terminal electrode shall be free from peeling or signs of peeling.   | <p>Applied force :<br/>Size 0402, 0603 : 5 N<br/>Duration : 10 s</p> <p>Size : 0402</p>  <p>Size : 0603</p>   |  |                |                |                    |              |              |                    |              |              |
| Bending Strength                               | There shall be no cracks and other mechanical damage.<br>R <sub>25</sub> change : within ±5 %                                  | <p>Bending distance : 2 mm<br/>Bending speed : 1 mm/s</p>    |  |                |                |                    |              |              |                    |              |              |
| Resistance to Vibration                        | There shall be no cracks and other mechanical damage.<br>R <sub>25</sub> change : within ±2 %<br>B Value change : within ±1 %  | <p>Solder samples on a testing substrate, then apply vibration to them.<br/>Acceleration : 5 G<br/>Vibrational frequency : 10 to 2000 Hz<br/>Sweep time : 20 minutes<br/>12 cycles in three directions, which are perpendicular to each other</p>  |  |                |                |                    |              |              |                    |              |              |
| Resistance to Impact                           | There shall be no cracks and other mechanical damage.<br>R <sub>25</sub> change : within ±2 %<br>B Value change : within ±1 %  | <p>Solder samples on a testing substrate, then apply impacts to them.<br/>Pulse waveform : Semisinusoidal wave, 11 ms<br/>Impact acceleration : 50 G<br/>Impact direction : X-X', Y-Y', Z-Z' In 6 directions, three times each</p>   |  |                |                |                    |              |              |                    |              |              |



## Specification and Test Method

| Item                         | Specification   | Test Method  |           |            |            |   |           |            |   |            |            |
|------------------------------|---|--|-----------|------------|------------|---|-----------|------------|---|------------|------------|
| Resistance to Soldering Heat | There shall be no cracks and other mechanical damage.<br><br>R <sub>25</sub> change : within ±2 %<br>B Value change : within ±1 % | Soldering bath method<br>Solder temperature : 260 ±5 °C, 270 ±5 °C<br>Dipping period : 3.0 ±0.5 s, 10.0 ±0.5 s<br>Preheat condition :  |           |            |            |   |           |            |   |            |            |
|                              |   | <table border="1"> <thead> <tr> <th>Step</th> <th>Temp (°C)</th> <th>Period (s)</th> </tr> </thead> <tbody> <tr> <td>1</td> <td>80 to 100</td> <td>120 to 180</td> </tr> <tr> <td>2</td> <td>150 to 200</td> <td>120 to 180</td> </tr> </tbody> </table> | Step      | Temp (°C)  | Period (s) | 1 | 80 to 100 | 120 to 180 | 2 | 150 to 200 | 120 to 180 |
|                              |   | Step   | Temp (°C) | Period (s) |            |   |           |            |   |            |            |
| 1                            | 80 to 100   | 120 to 180   |           |            |            |   |           |            |   |            |            |
| 2                            | 150 to 200  | 120 to 180   |           |            |            |   |           |            |   |            |            |
|                              |   |  |           |            |            |   |           |            |   |            |            |
| Solderability                | More than 95 % of the soldered area of both terminal electrodes shall be covered with fresh solder.                               | Soldering bath method<br>Solder temperature : 230 ±5 °C<br>Dipping period : 4 ±1 s<br>Solder : Sn-3.0Ag-0.5Cu  |           |            |            |   |           |            |   |            |            |
| Temperature Cycling          | R <sub>25</sub> change : within ±2 %<br>B Value change : within ±1 %  | Conditions of one cycle<br>Step 1 : -55±3 °C, 30±3 min.<br>Step 2 : Room temp., 3 min. max.<br>Step 3 : 125±5 °C, 30±3 min.<br>Step 4 : Room temp., 3 min. max.<br>Number of cycles: 2000 cycles   |           |            |            |   |           |            |   |            |            |
| Humidity                     | R <sub>25</sub> change : within ±2 %<br>B Value change : within ±1 %  | Temperature : 85 ±2 °C<br>Relative humidity : 85 ±5 %<br>Test period : 2000 +48/0 h  |           |            |            |   |           |            |   |            |            |
| Biased Humidity              | R <sub>25</sub> change : within ±2 %<br>B Value change : within ±1 %  | Temperature : 85 ±2 °C<br>Relative humidity : 85 ±5 %<br>Applied power : 10 mW(D.C.)<br>Test period : 2000 +48/0 h   |           |            |            |   |           |            |   |            |            |
| Low Temperature Exposure     | R <sub>25</sub> change : within ±2 %<br>B Value change : within ±1 %  | Temperature : -40 ±3 °C<br>Test period : 2000 +48/0 h  |           |            |            |   |           |            |   |            |            |
| High Temperature Exposure 1  | R <sub>25</sub> change : within ±2 %<br>B Value change : within ±1 %  | Temperature : 125 ±3 °C<br>Test period : 2000 +48/0 h  |           |            |            |   |           |            |   |            |            |
| High Temperature Exposure 2  | R <sub>25</sub> change : within ±3 %<br>B Value change : within ±2 %  | Temperature : 150 ±3 °C<br>Test period : 1000 +48/0 h  |           |            |            |   |           |            |   |            |            |

## Dimensions in mm (not to scale)

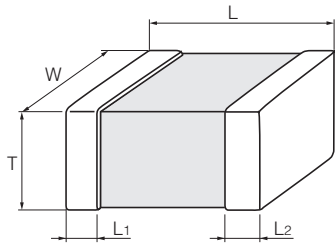

| Size Code (EIA) | L         | W         | T         | L <sub>1</sub> , L <sub>2</sub> |
|-----------------|-----------|-----------|-----------|---------------------------------|
| 0 (0402)        | 1.0±0.1   | 0.50±0.05 | 0.50±0.05 | 0.25±0.15                       |
| 1 (0603)        | 1.60±0.15 | 0.8±0.1   | 0.8±0.1   | 0.3±0.2                         |

(Unit: mm)

## Packaging Methods

### Standard Packing Quantities

| Size Code | Thickness (mm) | Kind of Taping         | Pitch (mm) | Quantity (pcs./reel) |
|-----------|----------------|------------------------|------------|----------------------|
| 0 (0402)  | 0.5            | Punched Carrier Taping | 2          | 10,000               |
| 1 (0603)  | 0.8            |                        | 4          | 4,000                |

### Reel for Taping

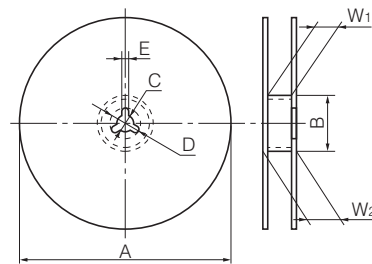

| Symbol    | φA                  | φB                                | C        | D        | E       | W <sub>1</sub>                   | W <sub>2</sub> |
|-----------|---------------------|-----------------------------------|----------|----------|---------|----------------------------------|----------------|
| Dim. (mm) | 180 <sup>-0.3</sup> | 60.0 <sup>+1.0</sup> <sub>0</sub> | 13.0±0.5 | 21.0±0.8 | 2.0±0.5 | 9.0 <sup>+1.0</sup> <sub>0</sub> | 11.4±1.0       |

### Pitch 2 mm (Punched Carrier Taping) : Size 0402

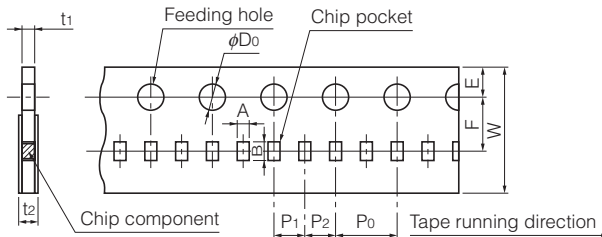

| Symbol    | A          | B          | W        | F          | E          | P <sub>1</sub> | P <sub>2</sub> | P <sub>0</sub> | φD <sub>0</sub>                  | t <sub>1</sub> | t <sub>2</sub> |
|-----------|------------|------------|----------|------------|------------|----------------|----------------|----------------|----------------------------------|----------------|----------------|
| Dim. (mm) | 0.62 ±0.05 | 1.12 ±0.05 | 8.0 ±0.2 | 3.50 ±0.05 | 1.75 ±0.10 | 2.00 ±0.05     | 2.00 ±0.05     | 4.0 ±0.1       | 1.5 <sup>+0.1</sup> <sub>0</sub> | 0.7 max.       | 1.0 max.       |

### Pitch 4 mm (Punched Carrier Taping) : Size 0603

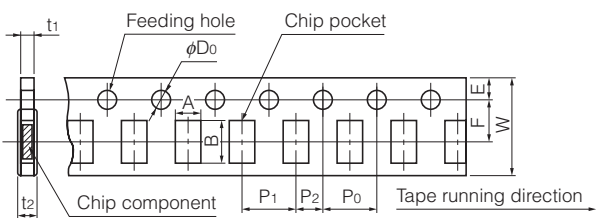

| Symbol    | A        | B        | W        | F          | E          | P <sub>1</sub> | P <sub>2</sub> | P <sub>0</sub> | φD <sub>0</sub>                  | t <sub>1</sub> | t <sub>2</sub> |
|-----------|----------|----------|----------|------------|------------|----------------|----------------|----------------|----------------------------------|----------------|----------------|
| Dim. (mm) | 1.0 ±0.1 | 1.8 ±0.1 | 8.0 ±0.2 | 3.50 ±0.05 | 1.75 ±0.10 | 4.0 ±0.1       | 2.00 ±0.05     | 4.0 ±0.1       | 1.5 <sup>+0.1</sup> <sub>0</sub> | 1.1 max.       | 1.4 max.       |

### Leader Part and Taped End

#### Leader part

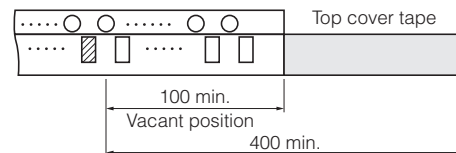

#### Taped end



## Minimum Quantity / Packing Unit

| Part Number (Size) | Minimum Quantity/ Packing Unit | Packing Quantity in Carton | Carton L×W×H (mm) |
|--------------------|--------------------------------|----------------------------|-------------------|
| ERTJ0 (0402)       | 10,000                         | 200,000                    | 250×200×200       |
| ERTJ1 (0603)       | 4,000                          | 80,000                     | 250×200×200       |

Part No., quantity and country of origin are designated on outer packages in English.

# Multilayer NTC Thermistors (Automotive Grade)

Series: ERTJ

## Handling Precautions

### [Precautions]

- **Do not use the products beyond the descriptions in this product catalog.**
- **This product catalog guarantees the quality of the products as individual components. Before you use the products, please make sure to check and evaluate the products in the circumstance where they are installed in your product.**

### Safety Precautions

Multilayer NTC Thermistors for Automotive Grade (hereafter referred to as “Thermistors”) are intended to be used in general-purpose applications as measures against Temperature detection and Temperature compensation in automotive Grade equipment.

When subjected to severe electrical, environmental, and/or mechanical stress beyond the specifications, as noted in the Ratings and Specified Conditions section, the Thermistors’ performance may be degraded, or become failure mode, such as short circuit mode and open-circuit mode.

If you use under the condition of short-circuit, heat generation of Thermistors will occur by running large current due to application of voltage. There are possibilities of smoke emission, substrate burn-out, and, in the worst case, fire. For products which require high safety levels, please carefully consider how a single malfunction can affect your product. In order to ensure the safety in the case of a single malfunction, please design products with fail-safe, such as setting up protecting circuits, etc.

We are trying to improve the quality and the reliability, but the durability differs depending on the use environment and the use conditions. On use, be sure to confirm the actual product under the actual use conditions.

- For the following applications and conditions, please be sure to consult with our sales representative in advance and to exchange product specifications which conform to such applications.
    - When your application may have difficulty complying with the safety or handling precautions specified below.
    - High-quality and high-reliability required devices that have possibility of causing hazardous conditions, such as death or injury (regardless of directly or indirectly), due to failure or malfunction of the product.
- ① Aircraft and Aerospace Equipment (artificial satellite, rocket, etc.)
  - ② Submarine Equipment (submarine repeating equipment, etc.)
  - ③ Transportation Equipment (airplanes, trains, ship, traffic signal controllers, etc.)
  - ④ Power Generation Control Equipment  
(atomic power, hydroelectric power, thermal power plant control system, etc.)
  - ⑤ Medical Equipment (life-support equipment, pacemakers, dialysis controllers, etc.)
  - ⑥ Information Processing Equipment (large scale computer systems, etc.)
  - ⑦ Electric Heating Appliances, Combustion devices (gas fan heaters, oil fan heaters, etc.)
  - ⑧ Rotary Motion Equipment
  - ⑨ Security Systems
  - ⑩ And any similar types of equipment

### Strict Observance

#### 1. Confirmation of Rated Performance

The Thermistors shall be operated within the specified rating/performance.

Applications exceeding the specifications may cause deteriorated performance and/or breakdown, resulting in degradation and/or smoking or ignition of products. The following are strictly observed.

- (1) The Thermistors shall not be operated beyond the specified operating temperature range.
- (2) The Thermistors shall not be operated in excess of the specified maximum power dissipation.

#### 2. The Thermistors shall not be mounted near flammables.

## Operating Conditions and Circuit Design

### 1. Circuit Design

#### 1.1 Operating Temperature and Storage Temperature

When operating a components-mounted circuit, please be sure to observe the "Operating Temperature Range", written in delivery specifications. Storage temperature of PCB after mounting Thermistors, which is not operated, should be within the specified "Storage Temperature Range" in the delivery specifications. Please remember not to use the product under the condition that exceeds the specified maximum temperature.

#### 1.2 Operating Power

The electricity applied to between terminals of Thermistors should be under the specified maximum power dissipation. There are possibilities of breakage and burn-out due to excessive self-heating of Thermistors, if the power exceeds maximum power dissipation when operating. Please consider installing protection circuit for your circuit to improve the safety, in case of abnormal voltage application and so on. Thermistors' performance of temperature detection would be deteriorated if self-heating occurs, even when you use it under the maximum power dissipation. Please consider the maximum power dissipation and dissipation factor.

#### 【Maximum power dissipation】

- The Maximum power that can be continuously applied under static air at a certain ambient temperature. The Maximum power dissipation under an ambient temperature of 25 °C or less is the same with the rated maximum power dissipation, and Maximum power dissipation beyond 25 °C depends on the Decreased power dissipation curve below.

#### 【Dissipation factor】

- The constant amount power required to raise the temperature of the Thermistor 1 °C through self heat generation under stable temperatures.  
Dissipation factor (mW/°C) = Power consumption of Thermistor / Temperature rise of element.

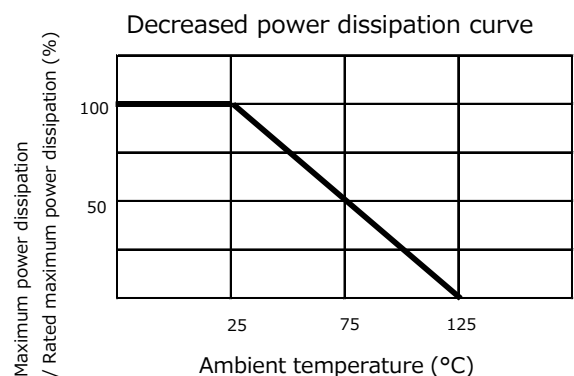

#### 1.3 Environmental Restrictions

The Thermistors does not take the use under the following special environments into consideration. Accordingly, the use in the following special environments, and such environmental conditions may affect the performance of the product; prior to use, verify the performance, reliability, etc. thoroughly.

- ① Use in liquids such as water, oil, chemical, and organic solvent.
- ② Use under direct sunlight, in outdoor or in dusty atmospheres.
- ③ Use in places full of corrosive gases such as sea breeze, Cl<sub>2</sub>, H<sub>2</sub>S, NH<sub>3</sub>, SO<sub>2</sub>, and NOx.
- ④ Use in environment with large static electricity or strong electromagnetic waves or strong radial ray.
- ⑤ Where the product is close to a heating component, or where an inflammable such as a polyvinyl chloride wire is arranged close to the product.
- ⑥ Where this product is sealed or coated with resin etc.
- ⑦ Where solvent, water, or water-soluble detergent is used in flux cleaning after soldering.  
(Pay particular attention to water-soluble flux.)
- ⑧ Use in such a place where the product is wetted due to dew condensation.
- ⑨ Use the product in a contaminated state.  
Ex.) Do not handle the product such as sticking sebum directly by touching the product after mounting printed circuit board.
- ⑩ Under severe conditions of vibration or impact beyond the specified conditions found in the Specifications.

#### 1.4 Measurement of Resistance

The resistance of the Thermistors varies depending on ambient temperatures and self-heating. To measure the resistance value when examining circuit configuration and conducting receiving inspection and so on, the following points should be taken into consideration:

- ① Measurement temp : 25±0.1 °C  
Measurement in liquid (silicon oil, etc.) is recommended for a stable measurement temperature.
- ② Power : 0.10 mW max. 4 terminal measurement with a constant-current power supply is recommended.

## 2. Design of Printed Circuit Board

### 2.1 Selection of Printed Circuit Boards

There is a possibility of performance deterioration by heat shock (temperature cycles), which causes cracks, from alumina substrate. Please confirm that the substrate you use does not deteriorate the Thermistors' quality.

### 2.2 Design of Land Pattern

(1) Recommended land dimensions are shown below. Use the proper amount of solder in order to prevent cracking. Using too much solder places excessive stress on the Thermistors..

Recommended Land Dimensions(Ex.)



| Size Code/EIA | Component dimensions |     |     | Unit (mm)  |            |            |
|---------------|----------------------|-----|-----|------------|------------|------------|
|               | L                    | W   | T   | a          | b          | c          |
| 0(0402)       | 1.0                  | 0.5 | 0.5 | 0.4 to 0.5 | 0.4 to 0.5 | 0.4 to 0.5 |
| 1(0603)       | 1.6                  | 0.8 | 0.8 | 0.8 to 1.0 | 0.6 to 0.8 | 0.6 to 0.8 |

(2) The land size shall be designed to have equal space, on both right and left side. If the amount of solder on both sides is not equal, the component may be cracked by stress since the side with a larger amount of solder solidifies later during cooling.

### Recommended Amount of Solder

(a) Excessive amount    (b) Proper amount    (c) Insufficient amount



### 2.3 Utilization of Solder Resist

(1) Solder resist shall be utilized to equalize the amounts of solder on both sides.

(2) Solder resist shall be used to divide the pattern for the following cases;

- Components are arranged closely.
- The Thermistor is mounted near a component with lead wires.
- The Thermistor is placed near a chassis.

Refer to the table below.

### Prohibited Applications and Recommended Applications

| Item  | Prohibited applications  | Improved applications by pattern division |
|---|--|---|
| Mixed mounting with a component with lead wires | The lead wire of a Component With lead wires<br>                   | Solder resist<br>                         |
| Arrangement near chassis                        | Chassis<br>Solder(ground solder)<br>Electrode pattern<br>          | Solder resist<br>                         |
| Retro-fitting of component with lead wires      | A lead wire of Retrofitted component<br>Soldering iron<br>iron<br> | Solder resist<br>                         |
| Lateral arrangement                             | Portion to be Excessively soldered<br>Land<br>                     | Solder resist<br>                         |

### 2.4 Component Layout

To prevent the crack of Thermistors, try to place it place it on the position that could not easily be affected by the bending stress of substrate while mounting procedures or procedures afterwards. Placement of the Thermistors near heating elements also requires the great care to be taken in order to avoid stresses from rapid heating and cooling.



- (1) To minimize mechanical stress caused by the warp or bending of a PC board, please follow the recommended Thermistors' layout below.

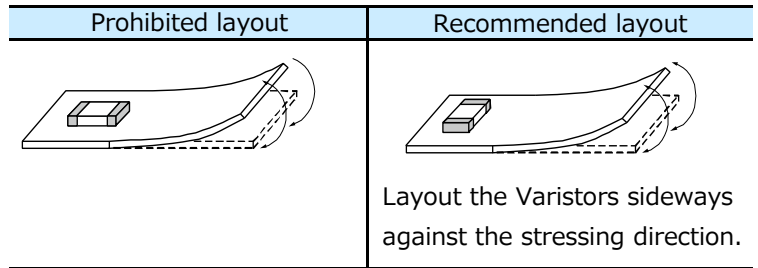

- (2) The following layout is for your reference since mechanical stress near the dividing/breaking position of a PC board varies depending on the mounting position of the Thermistors.

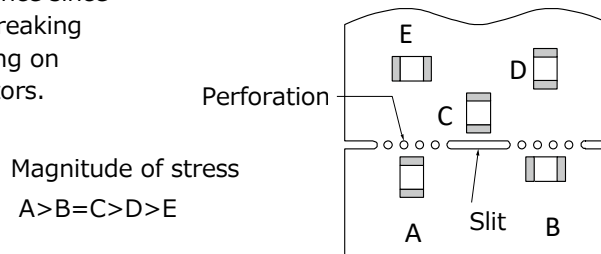

- (3) The magnitude of mechanical stress applied to the Thermistors when dividing the circuit board in descending order is as follows: push back < slit < V-groove < perforation. Also take into account the layout of the Thermistors and the dividing/breaking method.
- (4) When the Thermistors are placed near heating elements such as heater, etc., cracks from thermal stresses may occur under following situation:
- Soldering the Thermistors directly to heating elements.
  - Sharing the land with heating elements.
- If planning to conduct above-mentioned mounting and/or placement, please contact us in advance.

## 2.5 Mounting Density and Spaces

Intervals between components should not be too narrow to prevent the influence from solder bridges and solder balls. The space between components should be carefully determined.

## Precautions for Assembly

### 1. Storage

- (1) The Thermistors shall be stored between 5 to 40 °C and 20 to 70 % RH, not under severe conditions of high temperature and humidity.
- (2) If stored in a place where humidity, dust, or corrosive gasses (hydrogen sulfide, sulfurous acid, hydrogen chloride and ammonia, etc.) are contained, the solderability of terminals electrodes will be deteriorated. In addition, storage in a place where the heat or direct sunlight exposure occurs will causes or direct sunlight exposure occurs will causes mounting problems due to deformation of tapes and reels and components and taping/reels sticking together.
- (3) Do not store components longer than 6 months. Check the solderability of products that have been stored for more than 6 months before use.

### 2. Chip Mounting Consideration

- (1) When mounting the Thermistors/components on a PC board, the Thermistor bodies shall be free from excessive impact loads such as mechanical impact or stress due to the positioning, pushing force and displacement of vacuum nozzles during mounting.
- (2) Maintenance and inspection of the Chip Mounter must be performed regularly.
- (3) If the bottom dead center of the vacuum nozzle is too low, the Thermistor will crack from excessive force during mounting. The following precautions and recommendations are for your reference in use.
  - (a) Set and adjust the bottom dead center of the vacuum nozzles to the upper surface of the PC board after correcting the warp of the PC board.
  - (b) Set the pushing force of the vacuum nozzle during mounting to 1 to 3 N in static load.
  - (c) For double surface mounting, apply a supporting pin on the rear surface of the PC board to suppress the bending of the PC board in order to minimize the impact of the vacuum nozzles. Typical examples are shown in the table below.
  - (d) Adjust the vacuum nozzles so that their bottom dead center during mounting is not too low.

| Item                    | Prohibited mounting   | Recommended mounting  |
|-------------------------|---|---|
| Single surface mounting |  Crack                         |  Supporting pin<br>The supporting pin does not necessarily have to be positioned |
| Double surface mounting |  Separation of solder<br>Crack |  Supporting pin  |

- (4) The closing dimensions of the positioning chucks shall be controlled. Maintenance and replacement of positioning chucks shall be performed regularly to prevent chipping or cracking of the Thermistors caused by mechanical impact during positioning due to worn positioning chucks.
- (5) Maximum stroke of the nozzle shall be adjusted so that the maximum bending of PC board does not exceed 0.5 mm at 90 mm span. The PC board shall be supported by an adequate number of supporting pins.

### 3. Selection of Soldering Flux

Soldering flux may seriously affect the performance of the Thermistors. The following shall be confirmed before use.

- (1) The soldering flux should have a halogen based content of 0.1 wt% (converted to chlorine) or below. Do not use soldering flux with strong acid.
- (2) When applying water-soluble soldering flux, wash the Thermistors sufficiently because the soldering flux residue on the surface of PC boards may deteriorate the insulation resistance on the Thermistors' surface.

### 4. Soldering

#### 4.1 Reflow Soldering

The reflow soldering temperature conditions are composed of temperature curves of Preheating, Temp. rise, Heating, Peak and Gradual cooling. Large temperature difference inside the Thermistors caused by rapid heat application to the Thermistors may lead to excessive thermal stresses, contributing to the thermal cracks. The Preheating temperature requires controlling with great care so that tombstone phenomenon may be prevented.

Recommended profile of Reflow Soldering (Ex.)



| Item              | Temperature                   | Period or Speed |
|-------------------|-------------------------------|-----------------|
| ① Preheating      | 140 to 180 °C                 | 60 to 120 s     |
| ② Temp. rise      | Preheating temp to Peak temp. | 2 to 5 °C / s   |
| ③ Heating         | 220 °C min.                   | 60 s max.       |
| ④ Peak            | 260 °C max.                   | 10 s max.       |
| ⑤ Gradual cooling | Peak temp. to 140 °C          | 1 to 4 °C / s   |

$\Delta T$  : Allowable temperature difference  $\Delta T \leq 150$  °C

The rapid cooling (forced cooling) during Gradual cooling part should be avoided, because this may cause defects such as the thermal cracks, etc. When the Thermistors are immersed into a cleaning solvent, make sure that the surface temperatures of the devices do not exceed 100 °C. Performing reflow soldering twice under the conditions shown in the figure above [Recommended profile of Flow soldering (Ex.)] will not cause any problems. However, pay attention to the possible warp and bending of the PC board.

Recommended soldering condition is for the guideline for ensuring the basic characteristics of the components, not for the stable soldering conditions. Conditions for proper soldering should be set up according to individual conditions. The temperature of this product at the time of mounting changes depending on mounting conditions, therefore, please confirm that Product surface becomes the specified temperature when mounting it on the end product.

**4.2 Hand Soldering**

Hand soldering typically causes significant temperature change, which may induce excessive thermal stresses inside the Thermistors, resulting in the thermal cracks, etc. In order to prevent any defects, the following should be observed.

- The temperature of the soldering tips should be controlled with special care.
- The direct contact of soldering tips with the Thermistors and/or terminal electrodes should be avoided.
- Dismounted Thermistors shall not be reused.

(1) Condition 1 (with preheating)

- (a) Soldering : Use thread solder ( $\phi$  1.0 mm or below) which contains flux with low chlorine, developed for precision electronic equipment.
- (b) Preheating : Conduct sufficient pre-heating, and make sure that the temperature difference between solder and Thermistors' surface is 150 °C or less.
- (c) Temperature of Iron tip: 300 °C max.  
(The required amount of solder shall be melted in advance on the soldering tip.)
- (d) Gradual cooling : After soldering, the Thermistors shall be cooled gradually at room temperature.

Recommended profile of Hand soldering (Ex.)

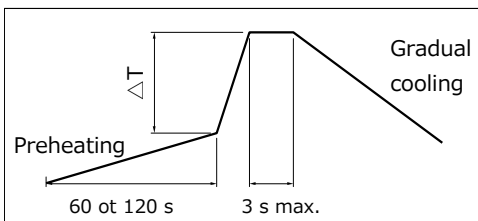

$\Delta T$  : Allowable temperature difference  $\Delta T \leq 150$  °C

(2) Condition 2 (without preheating)

Hand soldering can be performed without preheating, by following the conditions below:

- (a) Soldering iron tip shall never directly touch the ceramic and terminal electrodes of the Thermistors.
- (b) The lands are sufficiently preheated with a soldering iron tip before sliding the soldering iron tip to the terminal electrodes of the Thermistors for soldering.

Conditions of Hand soldering without preheating

| Item                                 | Condition        |
|--------------------------------------|------------------|
| Temperature of Iron tip              | 270 °C max.      |
| Wattage                              | 20 W max.        |
| Shape of Iron tip                    | $\phi$ 3 mm max. |
| Soldering time with a soldering iron | 3 s max.         |

**5. Post Soldering Cleaning**

**5.1 Cleaning solvent**

Soldering flux residue may remain on the PC board if cleaned with an inappropriate solvent. This may deteriorate the electrical characteristics and reliability of the Thermistors.

**5.2 Cleaning conditions**

Inappropriate cleaning conditions such as insufficient cleaning or excessive cleaning may impair the electrical characteristics and reliability of the Thermistors.

(1) Insufficient cleaning can lead to :

- (a) The halogen substance found in the residue of the soldering flux may cause the metal of terminal electrodes to corrode.
- (b) The halogen substance found in the residue of the soldering flux on the surface of the Thermistors may change resistance values.
- (c) Water-soluble soldering flux may have more remarkable tendencies of (a) and (b) above compared to those of rosin soldering flux.

(2) Excessive cleaning can lead to :

- (a) When using ultrasonic cleaner, make sure that the output is not too large, so that the substrate will not resonate. The resonance causes the cracks in Thermistors and/or solders, and deteriorates the strength of the terminal electrodes. Please follow these conditions for Ultrasonic cleaning:
  - Ultrasonic wave output : 20 W/L max.
  - Ultrasonic wave frequency : 40 kHz max.
  - Ultrasonic wave cleaning time : 5 min. max.

**5.3 Contamination of Cleaning solvent**

Cleaning with contaminated cleaning solvent may cause the same results as that of insufficient cleaning due to the high density of liberated halogen.

**6. Inspection Process**

The pressure from measuring terminal pins might bend the PCB when implementing circuit inspection after mounting Thermistors on PCB, and as a result, cracking may occur.

- (1) Mounted PC boards shall be supported by an adequate number of supporting pins on the back with bend settings of 90 mm span 0.5 mm max.
- (2) Confirm that the measuring pins have the right tip shape, are equal in height, have the right pressure and are set in the correct positions. The following figures are for your reference to avoid bending the PC board.

| Item                | Prohibited mounting   | Recommended mounting  |
|---------------------|---|---|
| Bending of PC board |  <p>Separated, Crack</p> |  <p>Supporting pin</p> |

**7. Protective Coating**

Make sure characteristics and reliability when using the resin coating or resin embedding for the purpose of improvement of humidity resistance or gas resistance, or fixing of parts because failures of a thermistors such as 1) ,2) and 3) may be occurred.

- (1) The solvent which contained in the resin permeate into the Thermistors, and it may deteriorate the characteristic.
- (2) When hardening the resin, chemical reaction heat (curing heat generation) happen and it may occurs the infection to the Thermistors.
- (3) The lead wire might be cut down and the soldering crack might be happen by expansion or contraction of resin hardening.

**8. Dividing/Breaking of PC Boards**

- (1) Please be careful not to stress the substrate with bending/twisting when dividing, after mounting components including Thermistors. Abnormal and excessive mechanical stress such as bending or torsion shown below can cause cracking in the Thermistors.

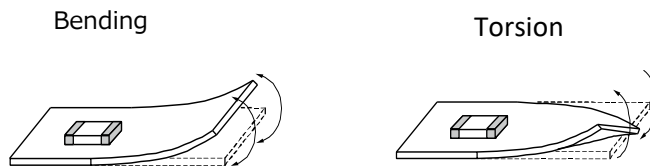

- (2) Dividing/Breaking of the PC boards shall be done carefully at moderate speed by using a jig or apparatus to prevent the Thermistors on the boards from mechanical damage.
- (3) Examples of PCB dividing/breaking jigs: The outline of PC board breaking jig is shown below. When PC board are broken or divided, loading points should be close to the jig to minimize the extent of the bending. Also, planes with no parts mounted on should be used as plane of loading, in order to prevent tensile stress induced by the bending, which may cause cracks of the Thermistors or other parts mounted on the PC boards.



## 10. Mechanical Impact

- (1) The Thermistors shall be free from any excessive mechanical impact.

The Thermistor body is made of ceramics and may be damaged or cracked if dropped. Never use a Thermistor which has been dropped; their quality may already be impaired, and in that case, failure rate will increase.

- (2) When handling PC boards with Thermistors mounted on them, do not allow the Thermistors to collide with another PC board.

When mounted PC boards are handled or stored in a stacked state, the corner of a PC board might strike Thermistors, and the impact of the strike may cause damage or cracking and can deteriorate the withstand voltage and insulation resistance of the Thermistors.



- 11.** Do not reuse this product after removal from the mounting board.

## Precautions for discarding

As to the disposal of the Thermistors, check the method of disposal in each country or region where the modules are incorporated in your products to be used.

## Other

The Thermistors precautions described above are typical. For special mounting conditions, please contact us. The technical information in this catalog provides example of our products' typical operations and application circuit.

## Applicable laws and regulations , others

1. This product not been manufactured with any ozone depleting chemical controlled under the Montreal Protocol.
2. This product comply with RoHS(Restriction of the use of certain Hazardous Substance in electrical and electronic equipment) (DIRECTIVE 2011/65/EU and 2015/863/EU).
3. All the materials used in this part are registered material under the Law Concerning the Examination and Regulation of Manufacture, etc. of Chemical Substance.
4. If you need the notice by letter of "A preliminary judgement on the Laws of Japan foreign exchange and Foreign Trade Control", be sure to let us know.
5. These products are not dangerous goods on the transportation as identified by UN (United nations) numbers or UN classification.
6. The technical information in this catalog provides example of our products' typical operations and application circuit. We do not guarantee the non-infringement of third party's intellectual property rights and we do not grant any license, Right or interest in our intellectual property.

## AEC-Q200 Compliant

The products are tested based on all or part of the test conditions and methods defined in AEC-Q200. Please consult with Panasonic for the details of the product specification and specific evaluation test results, etc., and please review and approve Panasonic's product specification before ordering.

## “PGS” Graphite Sheets

Type: EYG

“PGS (Pyrolytic Graphite Sheet)” is a thermal interface which is very thin, synthetically made, has high thermal conductivity, and is made from a highly oriented graphite polymer film. It is ideal for providing thermal management/heat-sinking in limited spaces or to provide supplemental heat-sinking in addition to conventional means.

This material is flexible and can be cut into customizable shapes. SSM(Semi-Sealing Material) is the product which is compounding PGS Graphite sheet and High thermal conductive Elastomer resin. It has a function to absorb heat by resin and release the heat by utilizing high thermal conductivity of PGS Graphite sheet. It also enables taking better attachment to the component which has different height on the electronic board, reducing stress to the electronic board.

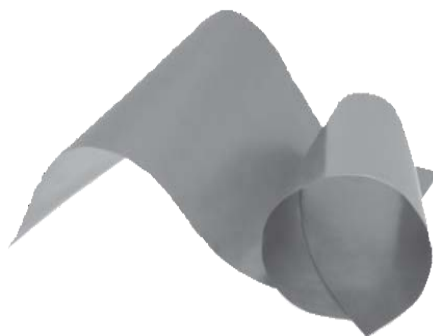

### Features

- Excellent thermal conductivity : 700 to 1950 W/(m·K)  
(2 to 5 times as high as copper, 3 to 8 times as high as aluminum)
- Lightweight: Specific gravity : 0.85 to 2.13 g/cm<sup>3</sup>  
(1/4 to 1/10 of copper, 1/1.3 to 1/3 of aluminum in density)
- Flexible and easy to be cut or trimmed. (withstands repeated bending)
- Low thermal resistance
- Low heat resistance with flexible Graphite sheet (SSM)
- Low repulsion and easy to keep the product's shape after attaching (SSM)
- Siloxane Free (SSM)
- High dielectric voltage : 17 kVac/mm (SSM)
- RoHS compliant

### Recommended applications

- Smart phones, Mobile phones, DSC, DVC, Tablet PCs, PCs and peripherals, LED Devices
- Semiconductor manufacturing equipment (Sputtering, Dry etching, Steppers)
- Optical communications equipment

### Explanation of Part Numbers

- PGS only (EYGS\*\*\*\*\*)

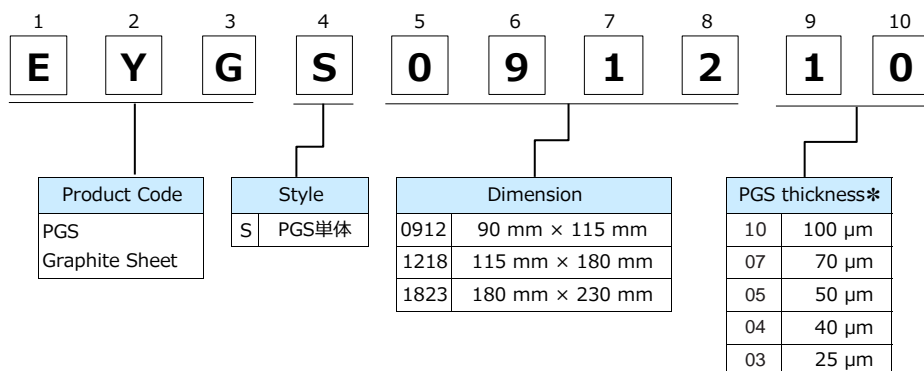

\*PGS thickness of 17 μm, 10 μm does not than those above.



**Explanation of Part Numbers**

● Taping (EYGA\*\*\*\*\*)

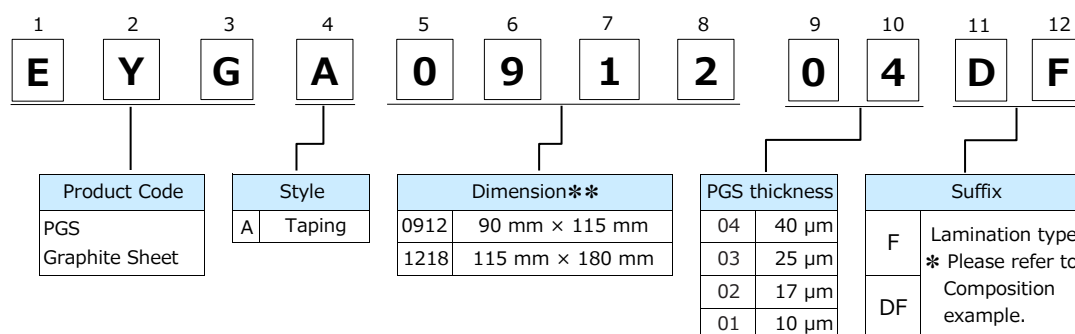
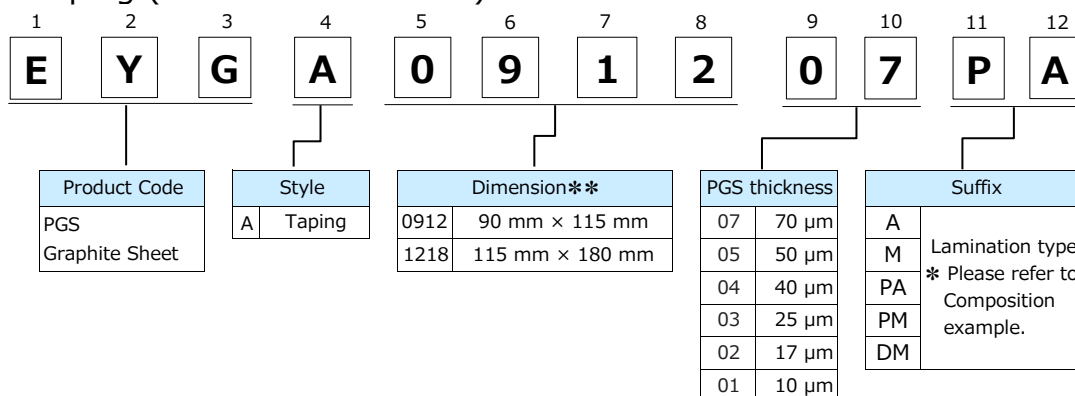

\*\* Please contact us for other dimensions other than those above.

● Thermally conductive elastomer processing (EYGE\*\*\*\*\*)

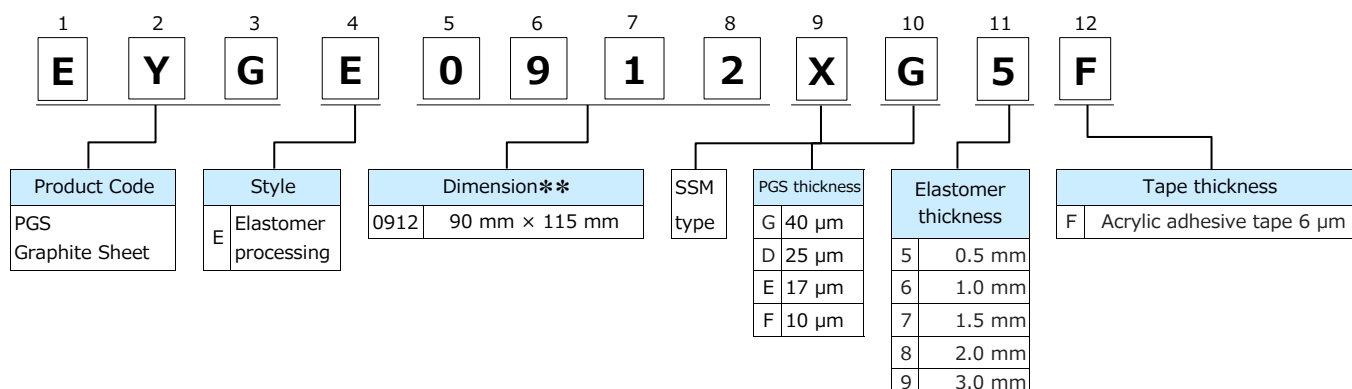
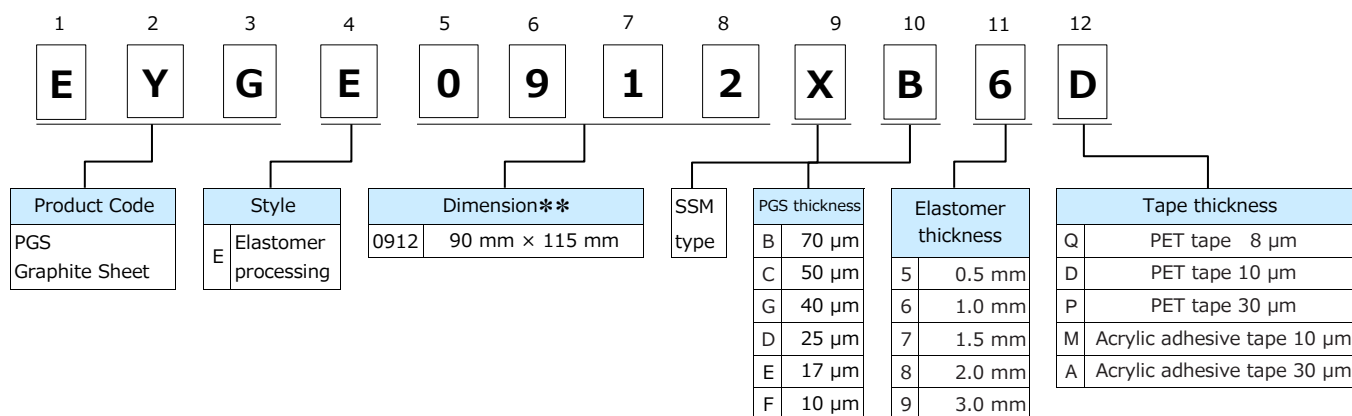

\*\* Please contact us for other dimensions other than those above.

## Characteristics of PGS Graphite Sheets

| Thickness               |           | 100 μm                   | 70 μm                    | 50 μm                    | 40 μm                    |
|-------------------------|-----------|--------------------------|--------------------------|--------------------------|--------------------------|
|                         |           | 0.10±0.03 mm             | 0.07±0.015 mm            | 0.050±0.015 mm           | 0.040±0.012 mm           |
| Density                 |           | 0.85 g/cm <sup>3</sup>   | 1.21 g/cm <sup>3</sup>   | 1.70 g/cm <sup>3</sup>   | 1.80 g/cm <sup>3</sup>   |
| Thermal conductivity    | a-b plane | 700 W/(m·K)              | 1000 W/(m·K)             | 1300 W/(m·K)             | 1350 W/(m·K)             |
| Electrical conductivity |           | 10000 S/cm               | 10000 S/cm               | 10000 S/cm               | 10000 S/cm               |
| Extensional strength    |           | 20.0 MPa                 | 20.0 MPa                 | 20.0 MPa                 | 25.0 MPa                 |
| Expansion coefficient   | a-b plane | 9.3×10 <sup>-7</sup> 1/K | 9.3×10 <sup>-7</sup> 1/K | 9.3×10 <sup>-7</sup> 1/K | 9.3×10 <sup>-7</sup> 1/K |
|                         | c axis    | 3.2×10 <sup>-5</sup> 1/K | 3.2×10 <sup>-5</sup> 1/K | 3.2×10 <sup>-5</sup> 1/K | 3.2×10 <sup>-5</sup> 1/K |
| Heat resistance*        |           | 400 °C                   |                          |                          |                          |
| Bending(angle 180,R5)   |           | 10000 cycles             |                          |                          |                          |

| Thickness               |           | 25 μm                    | 17 μm                    | 10 μm                    |
|-------------------------|-----------|--------------------------|--------------------------|--------------------------|
|                         |           | 0.025±0.010 mm           | 0.017±0.005 mm           | 0.010±0.002 mm           |
| Density                 |           | 1.90 g/cm <sup>3</sup>   | 2.10 g/cm <sup>3</sup>   | 2.13 g/cm <sup>3</sup>   |
| Thermal conductivity    | a-b plane | 1600 W/(m·K)             | 1850 W/(m·K)             | 1950 W/(m·K)             |
| Electrical conductivity |           | 20000 S/cm               | 20000 S/cm               | 20000 S/cm               |
| Extensional strength    |           | 30.0 MPa                 | 40.0 MPa                 | 40.0 MPa                 |
| Expansion coefficient   | a-b plane | 9.3×10 <sup>-7</sup> 1/K | 9.3×10 <sup>-7</sup> 1/K | 9.3×10 <sup>-7</sup> 1/K |
|                         | c axis    | 3.2×10 <sup>-5</sup> 1/K | 3.2×10 <sup>-5</sup> 1/K | 3.2×10 <sup>-5</sup> 1/K |
| Heat resistance*        |           | 400 °C                   |                          |                          |
| Bending(angle 180,R5)   |           | 10000 cycles             |                          |                          |

\* Withstand temperature refers to PGS only. (Lamination material such as PET tape etc. is not included)

\*\* Values are for reference, not guaranteed.

## Characteristics of SSM (Elastomer)

| Thickness            |          | 1 mm                        | 2 mm                         | 3 mm                         |
|----------------------|----------|-----------------------------|------------------------------|------------------------------|
| Specific heat        |          | 1.4 J/(g·C)                 |                              |                              |
| Density              |          | 1.88 g/cm <sup>3</sup>      |                              |                              |
| Thermal conductivity |          | 1.6 W/(m·K)**               |                              |                              |
| Thermal resistance   | 100 kPa  | 7.53 (C·cm <sup>2</sup> )/W | 14.82 (C·cm <sup>2</sup> )/W | 19.48 (C·cm <sup>2</sup> )/W |
|                      | 200 kPa  | 6.71 (C·cm <sup>2</sup> )/W | 13.17 (C·cm <sup>2</sup> )/W | 16.01 (C·cm <sup>2</sup> )/W |
|                      | 300 kPa  | 5.90 (C·cm <sup>2</sup> )/W | 10.73 (C·cm <sup>2</sup> )/W | 11.38 (C·cm <sup>2</sup> )/W |
| Compressibility      | 100 kPa  | 4.93 %                      | 4.05 %                       | 4.43 %                       |
|                      | 200 kPa  | 9.58 %                      | 8.66 %                       | 14.04 %                      |
|                      | 300 kPa  | 18.41 %                     | 22.13 %                      | 40.49 %                      |
| Resistivity          |          | > 10×10 <sup>14</sup> Ω·cm  |                              |                              |
| Dielectric voltage   |          | > 17 kVac/mm                |                              |                              |
| Hardness (Type E)    |          | 39                          |                              |                              |
| Adhesive force       | SUS      | 39 mN/cm                    |                              |                              |
|                      | Aluminum | 31 mN/cm                    |                              |                              |
|                      | Glass    | 38 mN/cm                    |                              |                              |

\* Characteristics refer to Elastomer resin only.

\*\* Values are for reference, not guaranteed.

**Comparison of thermal conductivity (a-b plane)**

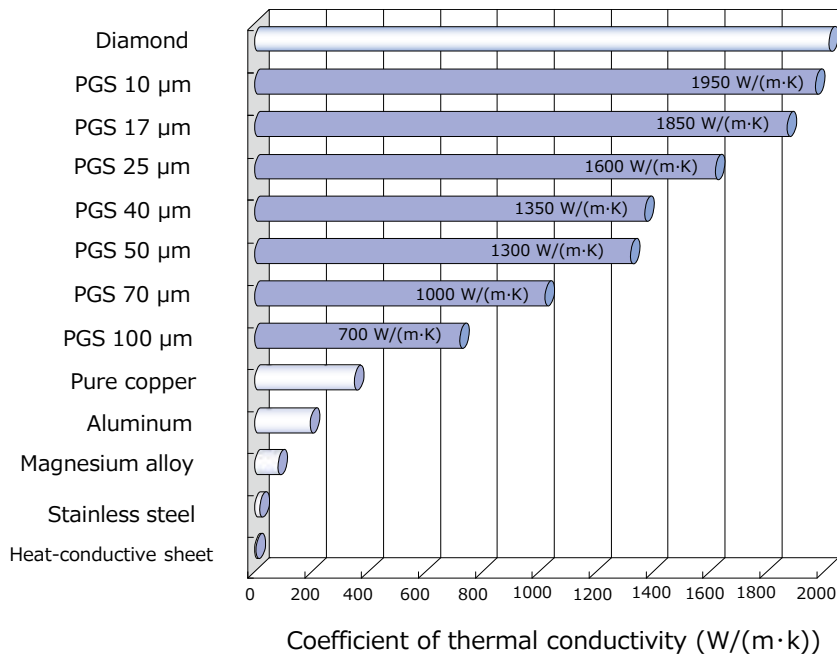

**Layered structure of PGS**

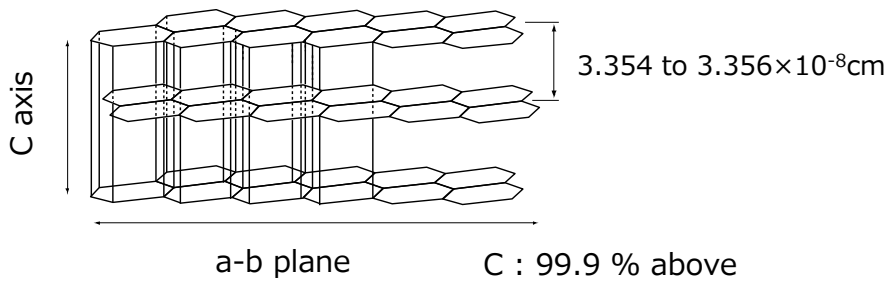

**Electric field shield performance**

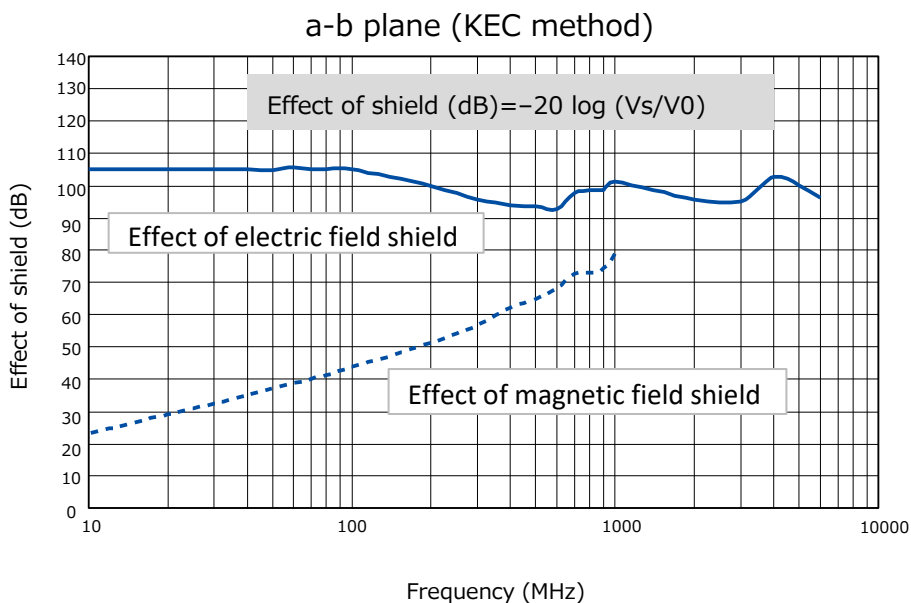

**Lamination type/Composition example**

- Standard series (PGS 100, 70, 50, 40, 25, 17, 10 μm)

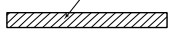
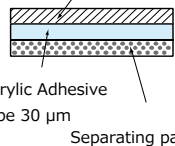
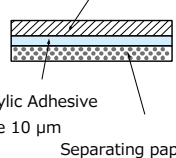
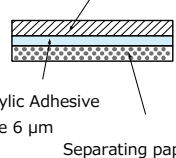
| Type                  | PGS Only   | Adhesive Type   |   |   |
|-----------------------|--|---|---|---|
|                       | S type   | A – A type  | A – M type  | A – F type  |
| Front face            | -  | -   | -   | -   |
| Rear face             | -  | Insulative adhesive tape 30 μm  | Insulative adhesive tape 10 μm  | Insulative adhesive tape 6 μm   |
| Structure             |  <p>PGS Graphite Sheet</p>  |  <p>PGS Graphite Sheet<br/>Acrylic Adhesive tape 30 μm<br/>Separating paper</p>                      |  <p>PGS Graphite Sheet<br/>Acrylic Adhesive tape 10 μm<br/>Separating paper</p>                       |  <p>PGS Graphite Sheet<br/>Acrylic Adhesive tape 6 μm<br/>Separating paper</p> |
| Features              | <ul style="list-style-type: none"> <li>◎High Thermal Conductivity</li> <li>High Flexibility</li> <li>◎Low Thermal Resistance</li> <li>◎Available up to 400 °C</li> <li>◎Conductive Material</li> </ul> | <ul style="list-style-type: none"> <li>◎With insulation material on one side</li> <li>◎With strong adhesive tape for putting chassis</li> <li>◎Withstanding Voltage : 2 kV</li> </ul> | <ul style="list-style-type: none"> <li>◎With insulation material on one side</li> <li>◎Low thermal resistance comparison with A-A type</li> <li>◎Withstanding Voltage : 1 kV</li> </ul> | <ul style="list-style-type: none"> <li>◎With insulation material on one side</li> <li>◎Low thermal resistance comparison with A-A type</li> </ul>                 |
| Withstand temperature | 400 °C   | 100 °C  | 100 °C  | 100 °C  |
| Standard size         | 115 × 180 mm   | 90 × 115 mm   | 90 × 115 mm   | 90 × 115 mm   |
| Maximum size          | 180 × 230 mm (25 μm ~)   | 115 × 180 mm  | 115 × 180 mm  | 115 × 180 mm  |
| 100 μm                | Part No.   | EYGS121810  | -   | -   |
|                       | Thickness  | 100 μm  | -   | -   |
| 70 μm                 | Part No.   | EYGS121807  | EYGA091207A   | EYGA091207M   |
|                       | Thickness  | 70 μm   | 100 μm  | 80 μm   |
| 50 μm                 | Part No.   | EYGS121805  | EYGA091205A   | EYGA091205M   |
|                       | Thickness  | 50 μm   | 80 μm   | 60 μm   |
| 40 μm                 | Part No.   | EYGS121804  | EYGA091204A   | EYGA091204M   |
|                       | Thickness  | 40 μm   | 70 μm   | 50 μm   |
| 25 μm                 | Part No.   | EYGS121803  | EYGA091203A   | EYGA091203M   |
|                       | Thickness  | 25 μm   | 55 μm   | 35 μm   |
| 17 μm                 | Part No.   | -   | EYGA091202A   | EYGA091202M   |
|                       | Thickness  | -   | 47 μm   | 27 μm   |
| 10 μm                 | Part No.   | -   | EYGA091201A   | EYGA091201M   |
|                       | Thickness  | -   | 40 μm   | 20 μm   |
|                       |  |   |   | 16 μm   |

\* Please contact us for other lamination type product.

\*\* Withstanding Voltages are for reference, not guaranteed.

**Lamination type/Composition example**

● Standard series (PGS 100, 70, 50, 40, 25, 17, 10 μm)

| Type                  | Laminated type (Insulation & Adhesive)   |  |  |  |
|-----------------------|--|--|--|--|
|                       | A – PA type  | A – PM type  | A – DM type  | A – DF type  |
| Front face            | Polyester tape standard type 30 μm   | Polyester tape standard type 30 μm   | Polyester tape standard type 10 μm   | Polyester tape standard type 10 μm   |
| Rear face             | Insulative adhesive tape 30 μm   | Insulative adhesive tape 10 μm   | Insulative adhesive tape 10 μm   | Insulative adhesive tape 6 μm  |
| Structure             |  |  |  |  |
| Features              | <ul style="list-style-type: none"> <li>◎With insulation material on one side</li> <li>◎Withstanding Voltage PET tape : 4 kV</li> <li>Adhesive Tape : 2 kV</li> </ul> | <ul style="list-style-type: none"> <li>◎With insulation material on one side</li> <li>◎Withstanding Voltage PET tape : 4 kV</li> <li>Adhesive Tape : 1 kV</li> </ul> | <ul style="list-style-type: none"> <li>◎With insulation material on one side</li> <li>◎Withstanding Voltage PET tape : 1 kV</li> <li>Adhesive Tape : 1 kV</li> </ul> | <ul style="list-style-type: none"> <li>◎With insulation material on one side</li> <li>◎Withstanding Voltage PET tape : 1 kV</li> </ul> |
| Withstand temperature | 100 °C   | 100 °C   | 100 °C   | 100 °C   |
| Standard size         | 90 × 115 mm  | 90 × 115 mm  | 90 × 115 mm  | 90 × 115 mm  |
| Maximum size          | 115 × 180 mm   | 115 × 180 mm   | 115 × 180 mm   | 115 × 180 mm   |
| 100 μm                | Part No.   | -  | -  | -  |
|                       | Thickness  | -  | -  | -  |
| 70 μm                 | Part No.   | EYGA091207PA   | EYGA091207PM   | EYGA091207DM   |
|                       | Thickness  | 130 μm   | 110 μm   | 90 μm  |
| 50 μm                 | Part No.   | EYGA091205PA   | EYGA091205PM   | EYGA091205DM   |
|                       | Thickness  | 110 μm   | 90 μm  | 70 μm  |
| 40 μm                 | Part No.   | EYGA091204PA   | EYGA091204PM   | EYGA091204DM   |
|                       | Thickness  | 100 μm   | 80 μm  | 60 μm  |
| 25 μm                 | Part No.   | EYGA091203PA   | EYGA091203PM   | EYGA091203DM   |
|                       | Thickness  | 85 μm  | 65 μm  | 45 μm  |
| 17 μm                 | Part No.   | EYGA091202PA   | EYGA091202PM   | EYGA091202DM   |
|                       | Thickness  | 77 μm  | 57 μm  | 37 μm  |
| 10 μm                 | Part No.   | EYGA091201PA   | EYGA091201PM   | EYGA091201DM   |
|                       | Thickness  | 70 μm  | 50 μm  | 30 μm  |

\* Please contact us for other lamination type product.

\*\* Withstanding Voltages are for reference, not guaranteed.

● Standard series (SSM)

| Type                  | E-6 type   | E-8 type   | E-9 type   |
|-----------------------|--|--|--|
| Elastomer thickness   | 1.0 mm   | 2.0 mm   | 3.0 mm   |
| Structure             |  |  |  |
| Features              | <ul style="list-style-type: none"> <li>◎Soft and low thermal resistance (Elastomer)</li> <li>◎Low repulsion</li> <li>◎Withstanding Voltage : 1.7 kV</li> </ul> | <ul style="list-style-type: none"> <li>◎Soft and low thermal resistance (Elastomer)</li> <li>◎Low repulsion</li> <li>◎Withstanding Voltage : 1.7 kV</li> </ul> | <ul style="list-style-type: none"> <li>◎Soft and low thermal resistance (Elastomer)</li> <li>◎Low repulsion</li> <li>◎Withstanding Voltage : 1.7 kV</li> </ul> |
| Withstand temperature | 100 °C   | 100 °C   | 100 °C   |
| Standard size         | 90 × 115 mm  | 90 × 115 mm  | 90 × 115 mm  |
| 70 μm                 | Part No.   | EYGE0912XB6D   | EYGE0912XB8D   |
|                       | Thickness  | 1.09 mm  | 2.09 mm  |
| 25 μm                 | Part No.   | EYGE0912XD6D   | EYGE0912XD8D   |
|                       | Thickness  | 1.05 mm  | 2.05 mm  |

|               |
|---------------|
| Minimum order |
|---------------|

| Item  | Type                 | Part No.     | Size       | Minimum order |
|---|----------------------|--------------|------------|---------------|
| PGS Graphite Sheet<br>Only  | S type<br>100 μm     | EYGS091210   | 90×115 mm  | 20            |
|   |                      | EYGS121810   | 115×180 mm | 10            |
|   |                      | EYGS182310   | 180×230 mm | 10            |
|   | S type<br>70 μm      | EYGS091207   | 90×115 mm  | 20            |
|   |                      | EYGS121807   | 115×180 mm | 10            |
|   |                      | EYGS182307   | 180×230 mm | 10            |
|   | S type<br>50 μm      | EYGS091205   | 90×115 mm  | 20            |
|   |                      | EYGS121805   | 115×180 mm | 10            |
|   |                      | EYGS182305   | 180×230 mm | 10            |
|   | S type<br>40 μm      | EYGS091204   | 90×115 mm  | 20            |
|   |                      | EYGS121804   | 115×180 mm | 10            |
|   |                      | EYGS182304   | 180×230 mm | 10            |
|   | S type<br>25 μm      | EYGS091203   | 90×115 mm  | 20            |
|   |                      | EYGS121803   | 115×180 mm | 10            |
|   |                      | EYGS182303   | 180×230 mm | 10            |
| PGS 70, 25, 17 μm<br>Adhesive Type<br>[Standard series]                             | A – A type<br>70 μm  | EYGA091207A  | 90×115 mm  | 20            |
|   |                      | EYGA121807A  | 115×180 mm | 10            |
|   | A – A type<br>25 μm  | EYGA091203A  | 90×115 mm  | 20            |
|   |                      | EYGA121803A  | 115×180 mm | 10            |
|   | A – A type<br>17 μm  | EYGA091202A  | 90×115 mm  | 20            |
|   |                      | EYGA121802A  | 115×180 mm | 10            |
|   | A – M type<br>70 μm  | EYGA091207M  | 90×115 mm  | 20            |
|   |                      | EYGA121807M  | 115×180 mm | 10            |
|   | A – M type<br>25 μm  | EYGA091203M  | 90×115 mm  | 20            |
|   |                      | EYGA121803M  | 115×180 mm | 10            |
|   | A – M type<br>17 μm  | EYGA091202M  | 90×115 mm  | 20            |
|   |                      | EYGA121802M  | 115×180 mm | 10            |
| PGS 70, 25, 17 μm<br>Laminated Type<br>(Insulation & Adhesive)<br>[Standard series] | A – PA type<br>70 μm | EYGA091207PA | 90×115 mm  | 20            |
|   |                      | EYGA121807PA | 115×180 mm | 10            |
|   | A – PA type<br>25 μm | EYGA091203PA | 90×115 mm  | 20            |
|   |                      | EYGA121803PA | 115×180 mm | 10            |
|   | A – PA type<br>17 μm | EYGA091202PA | 90×115 mm  | 20            |
|   |                      | EYGA121802PA | 115×180 mm | 10            |
|   | A – PM type<br>70 μm | EYGA091207PM | 90×115 mm  | 20            |
|   |                      | EYGA121807PM | 115×180 mm | 10            |
|   | A – PM type<br>25 μm | EYGA091203PM | 90×115 mm  | 20            |
|   |                      | EYGA121803PM | 115×180 mm | 10            |
|   | A – PM type<br>17 μm | EYGA091202PM | 90×115 mm  | 20            |
|   |                      | EYGA121802PM | 115×180 mm | 10            |
|   | A – DM type<br>70 μm | EYGA091207DM | 90×115 mm  | 20            |
|   |                      | EYGA121807DM | 115×180 mm | 10            |
|   | A – DM type<br>25 μm | EYGA091203DM | 90×115 mm  | 20            |
|   |                      | EYGA121803DM | 115×180 mm | 10            |
|   | A – DM type<br>17 μm | EYGA091202DM | 90×115 mm  | 20            |
|   |                      | EYGA121802DM | 115×180 mm | 10            |

- (1) Only S type supports 180×230 mm size.  
(PGS thickness of 17 μm, 10μm does not support as single item)
- (2) PGS of 10 μm, 40 μm, 50 μm type is also possible to be made as lamination type.
- (3) The above-listed part number is sample part number for testing.
- (4) Please contact us about your request of custom part number which will be arranged separately.
- (5) Please contact us if quantity is below Minimum Order Quantity.

|                      |
|----------------------|
| <b>Minimum order</b> |
|----------------------|

| Item  | Type   | Part No.     | Size      | Minimum order |
|---|--|--------------|-----------|---------------|
| SSM<br><br>Elastomer<br>3.0, 2.0, 1.0 mm<br>PGS 70, 25 μm | E – 9 type<br>Elastomer 3.0 mm,<br>PGS 70 μm | EYGE0912XB9D | 90×115 mm | 5             |
|   | E – 9 type<br>Elastomer 3.0 mm,<br>PGS 25 μm | EYGE0912XD9D | 90×115 mm | 5             |
|   | E – 8 type<br>Elastomer 2.0 mm,<br>PGS 70 μm | EYGE0912XD9D | 90×115 mm | 5             |
|   | E – 8 type<br>Elastomer 2.0 mm,<br>PGS 25 μm | EYGE0912XD8D | 90×115 mm | 5             |
|   | E – 6 type<br>Elastomer 1.0 mm,<br>PGS 70 μm | EYGE0912XB6D | 90×115 mm | 5             |
|   | E – 6 type<br>Elastomer 1.0 mm,<br>PGS 25 μm | EYGE0912XD6D | 90×115 mm | 5             |

- (1) Only S type supports 180×230 mm size.  
(PGS thickness of 17 μm, 10μm does not support as single item)
- (2) PGS of 10 μm, 40 μm, 50 μm type is also possible to be made as lamination type.
- (3) The above-listed part number is sample part number for testing.
- (4) Please contact us about your request of custom part number which will be arranged separately.
- (5) Please contact us if quantity is below Minimum Order Quantity.



## Precautions on the whole

- Do not use the products beyond the descriptions in this catalog.
- This catalog guarantees the quality of the products as individual components.  
Before you use the products, please make sure to check and evaluate the products in the circumstance where they are installed in your product.
- This product was designed and manufactured for standard applications such as general electronics devices, office equipment, information and communications equipment, measuring instruments, household appliances and audio-video equipment.  
For applications in which special quality and reliability are required, or if the failure or malfunction of the products may directly jeopardize life or cause threat of personal injury (such as for aircraft and aerospace equipment, traffic and transport equipment, combustion equipment, medical equipment, accident prevention and anti-theft devices, and safety equipment), please be sure to consult with our sales representative in advance and to exchange product catalog which conform to such applications.

## Safety and Design considerations

- We are trying to improve the quality and the reliability, but the durability differs depending on the use environment and the use conditions. On use, be sure to confirm the actual product under the actual use conditions.
- Install the following systems for a failsafe design to ensure safety if these products are to be used in equipment where a defect in these products may cause the loss of human life or other significant damage, such as damage to vehicles (automobile, train, vessel), traffic lights, medical equipment, aerospace equipment, electric heating appliances, combustion/ gas equipment, rotating equipment, and disaster/crime prevention equipment.
  - The system is equipped with a protection circuit and protection device.
  - The system is equipped with a redundant circuit or other system to prevent an unsafe status in the event of a single fault.
  - The system is equipped with an arresting the spread of fire or preventing glitch.
- When a dogma shall be occurred about safety for this product, be sure to inform us rapidly, operate your technical examination.
- The temperature of this product at the time of use changes depending on mounting conditions and usage conditions, therefore, please confirm that the temperature of this product is the specified temperature after mounting it.
- This product does not take the use under the following special environments into consideration. Accordingly, the use in the following special environments, and such environmental conditions may affect the performance of the product; prior to use, verify the performance, reliability, etc. thoroughly.
  - 1) Use in liquids such as water, oil, chemical, and organic solvent.
  - 2) Use under direct sunlight, in outdoor or in dusty atmospheres.
  - 3) Use in places full of corrosive gases such as sea breeze,  $C_{12}$ ,  $H_2S$ ,  $NH_3$ ,  $SO_2$ , and  $NO_x$ .
  - 4) Use the product in a contaminated state.
  - 5) Use in acid.
  - 6) Use outside the range defined by the operating temperature range.
  - 7) Use under reduced pressure or vacuum.

## Precaution of installation

- Do not reuse this product after removal from the mounting board.
- Do not drop this product on the floor. If this product is dropped, it can be damaged mechanically. Avoid using the dropped product.
- This product is soft, do not rub or touch it with rough materials to avoid scratching it.
- Lines or folds in this product may affect thermal conductivity.
- Never touch a this product during use because it may be extremely hot.
- Use protective materials when handling and/or applying this product, do not use items with sharp edges as they might tear or puncture this product.
- Do not handle with bare hands as there is a concern about performance degradation.

## Precaution on storage conditions

- Storage period is less than one year after our shipping inspection is completed. Please use within the period.
- If the product is stored in the following environments and conditions, the performance may be badly affected, avoid the storage in the following environments.
  - (1) Storage in places full of corrosive gases such as sea breeze,  $\text{Cl}_2$ ,  $\text{H}_2\text{S}$ ,  $\text{NH}_3$ ,  $\text{SO}_2$ , and  $\text{NO}_x$ .
  - (2) Storage in places exposed to ultraviolet light.
    - \*Recommended storage in the dark.
  - (3) Store at a temperature outside the storage temperature range specified by this catalog.
- In the case of a product configuration that assumes bonding, please use after checking the adhesiveness of the product when the storage period is over.

## Precaution specific to this product

- This product has conductivity. If required, This product should be provided insulation.
- This product can not guarantee the insulation because there is a concern for powder falling off of conductive materials.
- Thermal conductivity is dependent on the way it is used. Test the adaptability of the product to your application before use.

## Applicable laws and regulations, others

- No ODCs or other ozone-depleting substances which are subject to regulation under the Montreal Protocol are used in our manufacturing processes, including in the manufacture of this product.
- This product complies with the RoHS Directive (Restriction of the use of certain Hazardous Substances in electrical and electronic equipment (DIRECTIVE 2011/65/EU and (EU)2015/863) .
- All the materials used in this part are registered material under the Law Concerning the Examination and Regulation of Manufactures etc. of Chemical substances.
- If you need the notice by letter of "A preliminary judgment on the Laws of Japan foreign exchange and Foreign Trade control", be sure to let us know.
- These products are not dangerous goods on the transportation as identified by UN(United Nations) numbers or UN classification.
- As to the disposal of the module, check the method of disposal in each country or region where the modules are incorporated in your products to be used.
- The technical information in this catalog provides examples of our products typical operations and application circuits. We do not guarantee the non-infringement of third party's intellectual property rights and we do not grant any license, right, or interest in our intellectual property.

## "NASBIS" Insulating Sheet

Type: EGY

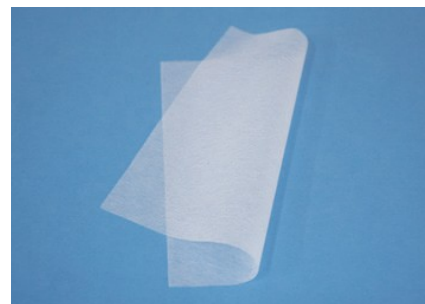

"NASBIS" is a heat insulating sheet, which is composed of silica aerogel and fiber sheet, created through impregnation process. Pore size of silica aerogel is 10 to 60nm, which means it has smaller space than the mean free path of the air, 68nm. Air molecules do not collide against each other inside the pores, and thus the component shows excellent heat insulation performance.

Furthermore, combining NASBIS and PGS Graphite Sheet enables controlling the direction of heat. Composite type provides greater heat insulating performance.

### Features

- Low thermal conductivity : 0.020 W/m · K typ.
- Created thin-film sheet ; Thickness : 100 μm to 1000 μm
- Various proposals are available when combined with PGS Graphite sheet
- RoHS compliant

### Recommended applications

- Smartphone, Wearable equipment, Digital Still Camera, Notebook PCs, Tablet PCs

### Explanation of Part Numbers

- NASBIS Pouch Type (EYGY0912QNP)

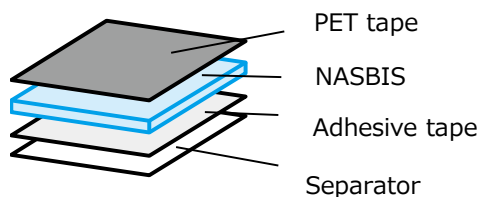
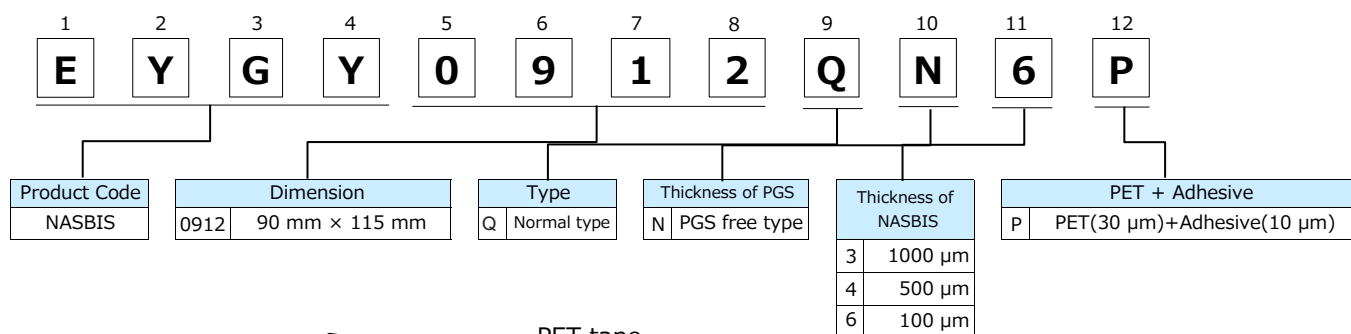

\* Please consult the other configurations separately.

### Characteristics of NASBIS

| Thickness                        | 100 μm         | 500 μm         | 1000 μm        |
|----------------------------------|----------------|----------------|----------------|
| Thermal conductivity (W/(m·K))   | 0.018 to 0.026 | 0.018 to 0.026 | 0.018 to 0.026 |
| Operating temperature limit (°C) | -20 to 100     | -20 to 100     | -20 to 100     |
| Size / Laminate pouch (mm)       | 90 × 115       | 90 × 115       | 90 × 115       |
| Heatproof temperature (°C)       | 100            | 100            | 100            |

Typical values, not guaranteed.

## Appearance of silica aerogel and its nanostructure

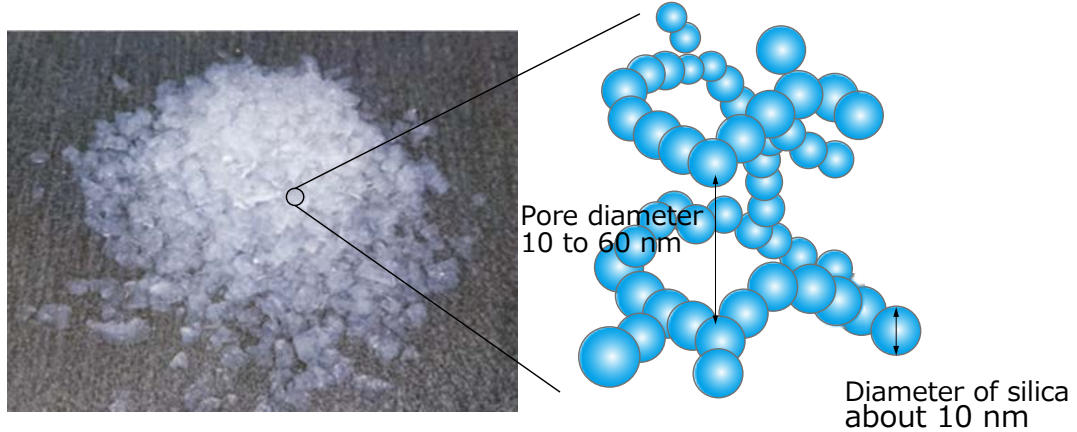

## Composition example

### ● NASBIS Pouch Type

| Type                  |                | Y - P type     |
|-----------------------|----------------|----------------|
| Structure             |                | PET 30 μm      |
|                       |                | NASBIS*        |
|                       |                | Adhesive 10 μm |
| Heatproof temperature |                | 100 °C         |
| 100 μm*               | Part No.       | EYGY0912QN6P   |
|                       | Thickness (μm) | 140            |
| 500 μm*               | Part No.       | EYGY0912QN4P   |
|                       | Thickness (μm) | 540            |
| 1000 μm*              | Part No.       | EYGY0912QN3P   |
|                       | Thickness (μm) | 1040           |

\* Above listed Part No. are examples for evaluation and selection, not for mass production. Customized service available for mass production spec.

■ Minimum order 10 pcs

## ⚠ Precautions on the whole

- Do not use the products beyond the descriptions in this catalog.
- This catalog guarantees the quality of the products as individual components.  
Before you use the products, please make sure to check and evaluate the products in the circumstance where they are installed in your product.
- This product was designed and manufactured for standard applications such as general electronics devices, office equipment, information and communications equipment, measuring instruments, household appliances and audio-video equipment.  
For applications in which special quality and reliability are required, or if the failure or malfunction of the products may directly jeopardize life or cause threat of personal injury (such as for aircraft and aerospace equipment, traffic and transport equipment, combustion equipment, medical equipment, accident prevention and anti-theft devices, and safety equipment), please be sure to consult with our sales representative in advance and to exchange product catalog which conform to such applications.

## Safety and Design considerations

- We are trying to improve the quality and the reliability, but the durability differs depending on the use environment and the use conditions. On use, be sure to confirm the actual product under the actual use conditions.
- Install the following systems for a failsafe design to ensure safety if these products are to be used in equipment where a defect in these products may cause the loss of human life or other significant damage, such as damage to vehicles (automobile, train, vessel), traffic lights, medical equipment, aerospace equipment, electric heating appliances, combustion/ gas equipment, rotating equipment, and disaster/crime prevention equipment.
  - The system is equipped with a protection circuit and protection device.
  - The system is equipped with a redundant circuit or other system to prevent an unsafe status in the event of a single fault.
  - The system is equipped with an arresting the spread of fire or preventing glitch.
- When a dogma shall be occurred about safety for this product, be sure to inform us rapidly, operate your technical examination.
- The temperature of this product at the time of use changes depending on mounting conditions and usage conditions, therefore, please confirm that the temperature of this product is the specified temperature after mounting it.
- This product does not take the use under the following special environments into consideration. Accordingly, the use in the following special environments, and such environmental conditions may affect the performance of the product; prior to use, verify the performance, reliability, etc. thoroughly.
  - 1) Use in liquids such as water, oil, chemical, and organic solvent.
  - 2) Use under direct sunlight, in outdoor or in dusty atmospheres.
  - 3) Use in places full of corrosive gases such as sea breeze,  $C_{12}$ ,  $H_2S$ ,  $NH_3$ ,  $SO_2$ , and  $NO_x$ .
  - 4) Use the product in a contaminated state.
  - 5) Use in the point being adhered to organic solvent (thinner, alcohol, xylene etc.) or chemical substances (oils, acids, alkali etc.), or being possible to contact with their.  
And use under their gas atmosphere.
  - 6) Use in an environment in contact with silicone resin.
  - 7) Use with ultrasonic and high frequency wave applied.
  - 8) Use under reduced pressure or vacuum.

## Precaution of installation

- Do not reuse this product after removal from the mounting board.
- Do not drop this product on the floor. If this product is dropped, it can be damaged mechanically. Avoid using the dropped product.
- Do not touch this product with bare hands.
- This product is soft, do not rub or touch it with rough and sharp-edged materials to avoid scratching it.
- Lines or folds in this product may affect thermal insulation.
- Never touch a this product during use because it may be extremely hot.

- Use protective materials when handling and/or applying this product, do not use items with sharp edges as they might tear or puncture this product.
- The NASBIS shall not be modified and done additional work such as cutting, drilling, nailing, eyelets, screwing, pinning, riveting, polishing, embossing, water cleaning, solvent cleaning, ozone cleaning, plasma exposure, ultraviolet irradiation, plating, painting, printing, deposition, etching, sputtering, heat treatment, surface treatment.
- The NASBIS shall not be reused, repaired and recycled.

### Precaution on storage conditions

- Storage period is less than one year after our shipping inspection is completed.  
Please use within the period.
- If the product is stored in the following environments and conditions, the performance may be badly affected, avoid the storage in the following environments.
  - (1) Storage in places full of corrosive gases such as sea breeze, Cl<sub>2</sub>, H<sub>2</sub>S, NH<sub>3</sub>, SO<sub>2</sub>, and NO<sub>x</sub>.
  - (2) Storage in places exposed to ultraviolet light. \*Recommended storage in the dark.
  - (3) Store at a temperature outside the storage temperature range specified by this catalog.
  - (4) Storage under a load.
- In the case of a product configuration that assumes bonding, please use after checking the adhesiveness of the product when the storage period is over.

### Precaution specific to this product

- NASBIS sheet may release silica powder (electric non-conduct).
- The adhesion between laminate film and NASBIS is very weak, so some parts may be un-bonded depending on the handling.
- The performance of thermal insulation is dependent on the way it is used. Test the adaptability of NASBIS to your application before use.
- The dimension of NASBIS sheet will change when the humidity changes. If you need a precise size we suggest that the NASBIS sheet should be controlled at a certain stored condition and period, and measured at the same conditions.  
ex) The dimensions of NASBIS are assured when stored and measured at 23±2 °C、50±20 %RH.
- The appearance is conducted based on internal standard. When suspicion arises, contact promptly us.

### Applicable laws and regulations, others

- No ODCs or other ozone-depleting substances which are subject to regulation under the Montreal Protocol are used in our manufacturing processes, including in the manufacture of this product.
- This product complies with the RoHS Directive (Restriction of the use of certain Hazardous Substances in electrical and electronic equipment (DIRECTIVE 2011/65/EU and (EU)2015/863) .
- All the materials used in this part are registered material under the Law Concerning the Examination and Regulation of Manufactures etc. of Chemical substances.
- If you need the notice by letter of "A preliminary judgment on the Laws of Japan foreign exchange and Foreign Trade control", be sure to let us know.
- These products are not dangerous goods on the transportation as identified by UN(United Nations) numbers or UN classification.
- As to the disposal of the module, check the method of disposal in each country or region where the modules are incorporated in your products to be used.
- The technical information in this catalog provides examples of our products typical operations and application circuits. We do not guarantee the non-infringement of third party's intellectual property rights and we do not grant any license, right, or interest in our intellectual property.

## “Graphite-PAD” high thermal conductivity in z-direction

Type: **EYGT**

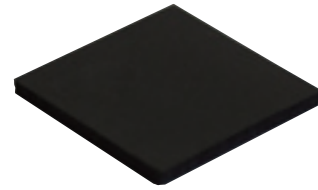

Graphite-PAD is a thermal interface material (TIM) that compatibly obtained excellent thermal conductivity in thickness direction (Z-axis direction) and high flexibility (deformable with a low load). The properties are greater than that of existing TIMs. The product is created by filling PGS Graphite Sheet into silicon resin.

### Features

- High thermal conductivity : 13 W/m · K
- Excellent compressibility : 50 % (t=2 mm, Pressure 300 kPa)
- Thermal resistance: fit into uneven parts and provide excellent thermal resistance with a low load
- High reliability : correspond to -40 to 150 °C and maintains long-term reliability
- Thickness range : 0.5/1.0/1.5/2.0/2.5/3.0 mm
- RoHS compliant

### Recommended applications

Cooling of heat generating components, such as electronic devices, semiconductor memory device, etc.

- General-purpose inverter, medical equipment, and DSC
- Car-mounted camera, motor control unit, automotive lighting (LED), car navigation, luminous source of laser HUD
- Base station, IGBT module

### Explanation of Part Numbers

- Graphite-PAD (EYGT\*\*\*\*\*A)

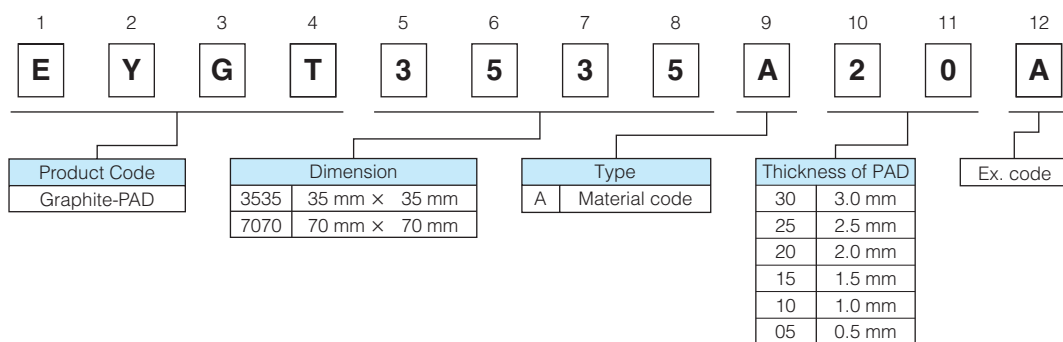

\* Please confirm other condition separately.



### Typical characteristics

| Items   | Test equipment/method | Condition       | Data                   |       |       |      |      |       |
|---|-----------------------|-----------------|------------------------|-------|-------|------|------|-------|
|   |                       |                 | 0.5                    | 1.0   | 1.5   | 2.0  | 2.5  | 3.0   |
| Thickness (mm)  |                       |                 | 0.5                    | 1.0   | 1.5   | 2.0  | 2.5  | 3.0   |
| Thermal resistance (K·cm <sup>2</sup> /W)   | TIM Tester            | 100 kPa         | 0.96                   | 1.34  | 1.56  | 1.93 | 2.10 | 2.36  |
| Compressibility (%)   | TIM Tester            | 100 kPa (50 °C) | 5.78                   | 10.29 | 17.46 | 17.8 | 17.6 | 17.9  |
| Thermal conductivity of Graphite-PAD with a unit (W/m·K) (including contact resistance) | TIM Tester            | 100 kPa         | 5.08                   | 7.02  | 7.80  | 8.60 | 9.66 | 10.10 |
| Thermal conductivity of the Graphite-PAD (W/m·K)  | (ASTM D5470)          | 50 kPa          | 13                     |       |       |      |      |       |
| Hardness  | (ASTM D2240)          | TYPE E          | 25                     |       |       |      |      |       |
| Adhesive  |                       |                 | Adhesive on both faces |       |       |      |      |       |
| Volume resistivity (Ω·cm)   | (ASTM D257)           |                 | 4×10 <sup>5</sup>      |       |       |      |      |       |
| Operating temperature range (°C)  |                       |                 | -40 to 150             |       |       |      |      |       |
| Siloxane  |                       | Σ (D4-D10)      | ≤ 70 ppm               |       |       |      |      |       |

### Structure

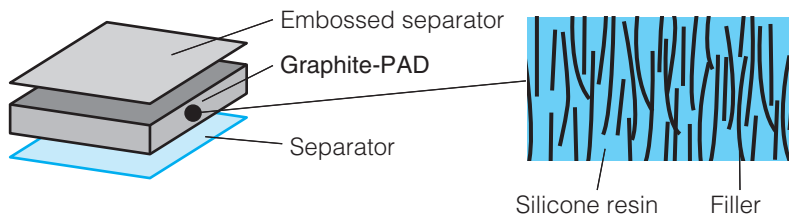

### Thermal resistance and Compressibility

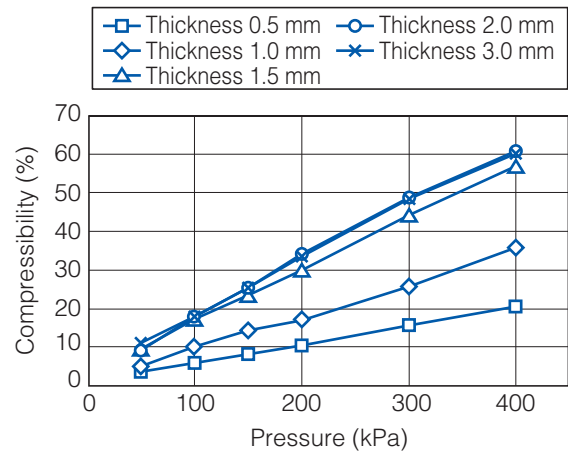
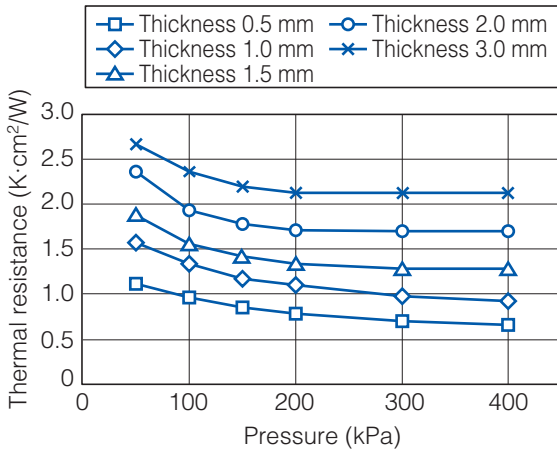

### Composition example

|                    |                   |                             |              |
|--------------------|-------------------|-----------------------------|--------------|
| Structure          |                   |                             |              |
|                    |                   | Operating temperature range |              |
| Standard dimension |                   | 35 × 35 mm                  | 70 × 70 mm   |
| 0.5 mm             | Standard Part No. | EYGT3535A05A                | EYGT7070A05A |
|                    | Thickness         | 0.5 mm                      | 0.5 mm       |
| 1.0 mm             | Standard Part No. | EYGT3535A10A                | EYGT7070A10A |
|                    | Thickness         | 1.0 mm                      | 1.0 mm       |
| 1.5 mm             | Standard Part No. | EYGT3535A15A                | EYGT7070A15A |
|                    | Thickness         | 1.5 mm                      | 1.5 mm       |
| 2.0 mm             | Standard Part No. | EYGT3535A20A                | EYGT7070A20A |
|                    | Thickness         | 2.0 mm                      | 2.0 mm       |
| 2.5 mm             | Standard Part No. | EYGT3535A25A                | EYGT7070A25A |
|                    | Thickness         | 2.5 mm                      | 2.5 mm       |
| 3.0 mm             | Standard Part No. | EYGT3535A30A                | EYGT7070A30A |
|                    | Thickness         | 3.0 mm                      | 3.0 mm       |

\* Part numbers listed above are all standard samples for your consideration.

\*\* Contact us for custom-made samples.

We can make samples in various forms and/or dimensions other than standard samples.

## Precautions on the whole

- Do not use the products beyond the descriptions in this catalog.
- This catalog guarantees the quality of the products as individual components.  
Before you use the products, please make sure to check and evaluate the products in the circumstance where they are installed in your product.
- This product was designed and manufactured for standard applications such as general electronics devices, office equipment, information and communications equipment, measuring instruments, household appliances and audio-video equipment.  
For applications in which special quality and reliability are required, or if the failure or malfunction of the products may directly jeopardize life or cause threat of personal injury (such as for aircraft and aerospace equipment, traffic and transport equipment, combustion equipment, medical equipment, accident prevention and anti-theft devices, and safety equipment), please be sure to consult with our sales representative in advance and to exchange product catalog which conform to such applications.

## Safety and Design considerations

- We are trying to improve the quality and the reliability, but the durability differs depending on the use environment and the use conditions. On use, be sure to confirm the actual product under the actual use conditions.
- Install the following systems for a failsafe design to ensure safety if these products are to be used in equipment where a defect in these products may cause the loss of human life or other significant damage, such as damage to vehicles (automobile, train, vessel), traffic lights, medical equipment, aerospace equipment, electric heating appliances, combustion/ gas equipment, rotating equipment, and disaster/crime prevention equipment.
  - The system is equipped with a protection circuit and protection device.
  - The system is equipped with a redundant circuit or other system to prevent an unsafe status in the event of a single fault.
  - The system is equipped with an arresting the spread of fire or preventing glitch.
- When a dogma shall be occurred about safety for this product, be sure to inform us rapidly, operate your technical examination.
- The temperature of this product at the time of use changes depending on mounting conditions and usage conditions, therefore, please confirm that the temperature of this product is the specified temperature after mounting it.
- This product does not take the use under the following special environments into consideration. Accordingly, the use in the following special environments, and such environmental conditions may affect the performance of the product; prior to use, verify the performance, reliability, etc. thoroughly.
  - 1) Use in liquids such as water, oil, chemical, and organic solvent.
  - 2) Use under direct sunlight, in outdoor or in dusty atmospheres.
  - 3) Use in places full of corrosive gases such as sea breeze,  $C_{12}$ ,  $H_2S$ ,  $NH_3$ ,  $SO_2$ , and  $NO_x$ .
  - 4) Use the product in a contaminated state.
  - 5) Use in acid.
  - 6) Use outside the range defined by the operating temperature range.
  - 7) Use under reduced pressure or vacuum.

## Precaution of installation

- Do not reuse this product after removal from the mounting board.
- Do not drop this product on the floor. If this product is dropped, it can be damaged mechanically. Avoid using the dropped product.
- This product is soft, do not rub or touch it with rough materials to avoid scratching it.
- Lines or folds in this product may affect thermal conductivity.
- Never touch a this product during use because it may be extremely hot.
- Use protective materials when handling and/or applying this product, do not use items with sharp edges as they might tear or puncture this product.
- Do not handle with bare hands as there is a concern about performance degradation.

## Precaution on storage conditions

- Storage period is less than one year after our shipping inspection is completed. Please use within the period.
- If the product is stored in the following environments and conditions, the performance may be badly affected, avoid the storage in the following environments.
  - (1) Storage in places full of corrosive gases such as sea breeze,  $\text{Cl}_2$ ,  $\text{H}_2\text{S}$ ,  $\text{NH}_3$ ,  $\text{SO}_2$ , and  $\text{NO}_x$ .
  - (2) Storage in places exposed to ultraviolet light.
    - \*Recommended storage in the dark.
  - (3) Store at a temperature outside the storage temperature range specified by this catalog.
- In the case of a product configuration that assumes bonding, please use after checking the adhesiveness of the product when the storage period is over.

## Precaution specific to this product

- This product has conductivity. If required, This product should be provided insulation.
- This product can not guarantee the insulation because there is a concern for powder falling off of conductive materials.
- Thermal conductivity is dependent on the way it is used. Test the adaptability of the product to your application before use.

## Applicable laws and regulations, others

- No ODCs or other ozone-depleting substances which are subject to regulation under the Montreal Protocol are used in our manufacturing processes, including in the manufacture of this product.
- This product complies with the RoHS Directive (Restriction of the use of certain Hazardous Substances in electrical and electronic equipment (DIRECTIVE 2011/65/EU and (EU)2015/863) .
- All the materials used in this part are registered material under the Law Concerning the Examination and Regulation of Manufactures etc. of Chemical substances.
- If you need the notice by letter of "A preliminary judgment on the Laws of Japan foreign exchange and Foreign Trade control", be sure to let us know.
- These products are not dangerous goods on the transportation as identified by UN(United Nations) numbers or UN classification.
- As to the disposal of the module, check the method of disposal in each country or region where the modules are incorporated in your products to be used.
- The technical information in this catalog provides examples of our products typical operations and application circuits. We do not guarantee the non-infringement of third party's intellectual property rights and we do not grant any license, right, or interest in our intellectual property.

### “GraphiteTIM(Compressible Type)” PGS with low thermal resistance

Type: **EYGS**



GraphiteTIM(Compressible Type) is a graphite sheet that is dedicated for use as a thermal interface material.

The GraphiteTIM(Compressible Type) has very high compressibility compared to standard PGS, which enables reducing the thermal resistance by following gap, warpage, and distortion of targets/substrates. Excellent heat resistance and reliability of the GraphiteTIM help obtaining longer service life and higher performance of various components, such as power modules.

The GraphiteTIM(Compressible Type) is cost-saving, because it may allow you to reduce your existing processes. Unlike grease, there is no necessity for printing process, since it is a sheet-type product.

There are no problems that are found in grease and phase change materials in the GraphiteTIM, which makes it excellent TIM.

#### Features

- Thermal resistance : 0.2K·cm<sup>2</sup>/W (600 kPa)  
To draw a good thermal resistance from sheet, pressure the GraphiteTIM. A close adherence would make the product fit into the uneven part and enhance the performance.
- Thermal conductivity : X-Y direction 400W/m·K, Z direction (28W/m·K)
- Compressibility : 40 % (600k Pa)
- High and long term reliability : operating temperature range -55 to 400 °C
- RoHs compliant

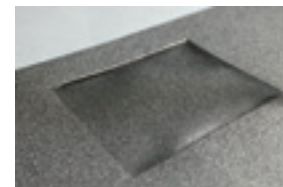

After pressure

#### Recommended applications

For cooling/heat transfer of electronic devices that generates heat, such as power modules.

- Inverters and converters
- Car-mounted camera, motor control unit, automotive LED, luminous source of laser HUD, medical equipment
- Base station, Server

Install in IGBT module

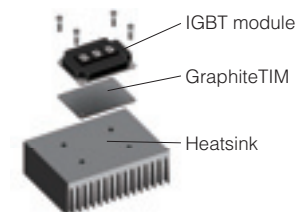

#### Explanation of Part Numbers

- GraphiteTIM(EYGS\*\*\*\*ZL\*\*)

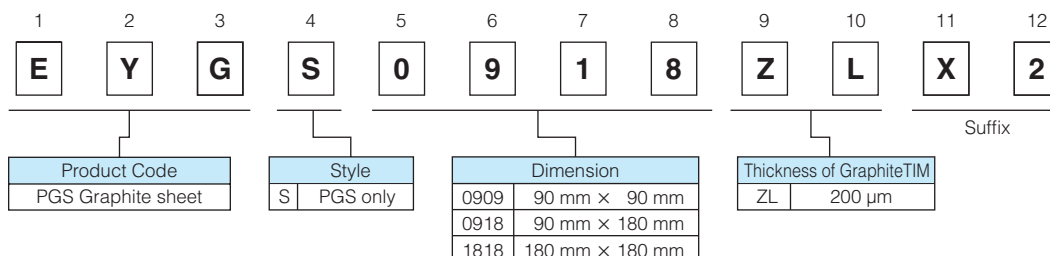

\* Please contact us for custom-made products.

### Typical characteristics

| Items                                     | Test method | Condition | Data             |
|---|-------------|-----------|------------------|
| Thickness (μm)                            |             |           | 200              |
| Thermal resistance (K·cm <sup>2</sup> /W) | TIM Tester  | 600 kPa   | 0.2              |
| Compressibility (%)                       | TIM Tester  | 600 kPa   | 40               |
| Thermal conductivity (W/m·K)              | Laser PIT   | X-Y       | 400 (300 to 600) |
|   |             | Z         | (28)             |
| Flame resistance                          | UL-94V      |           | V-0              |
| Operating temperature range (°C)          |             |           | -55 to 400       |

Typical values, not guaranteed.

### Thermal resistance and compressibility

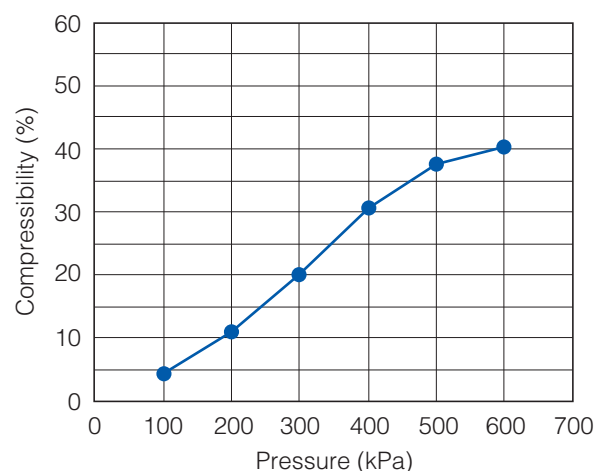
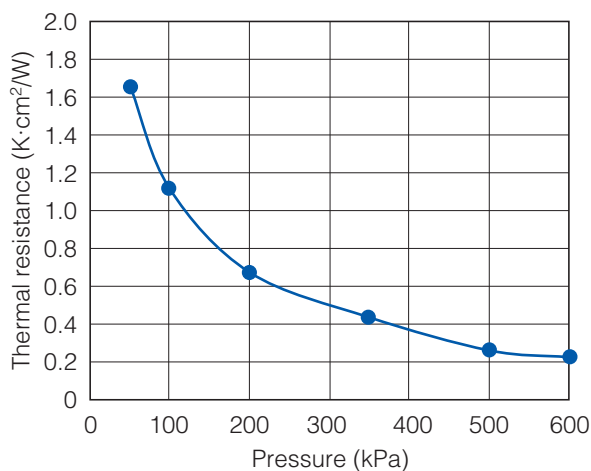

### Lamination type/Composition example

- GraphiteTIM(Compressible Type) standard form

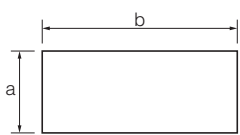
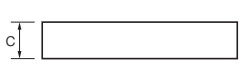

| Type                        |              | Sheet only  |
|-----------------------------|--------------|---|
|                             |              | S Type  |
| Process for IGBT mounting   |              | —   |
| Structure                   | Front        |  |
|                             | Side         |  |
| Operating Temperature Range |              | -55 to 400 °C   |
| Thickness: c                |              | 200 μm  |
| Standard Part No.           | 90 × 90 mm   | EYGS0909ZLX2  |
|                             | 90 × 180 mm  | EYGS0918ZLX2  |
|                             | 180 × 180 mm | EYGS1818ZLX2  |

\* Part numbers listed above are all standard samples for your consideration.

\*\* Contact us for custom-made samples.

We can make samples in various forms and/or dimensions other than standard samples.

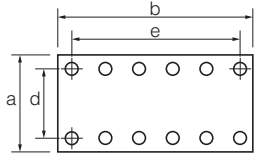
● PGS in IGBT forms

|                             |       |  |
|-----------------------------|-------|--|
| Type                        |       | Sheet only   |
|                             |       | S Type   |
| Process for IGBT mounting   |       | Lamination   |
| Structure                   | Front |  <p>* This shape is an example, please contact us for detailed shape of each part no.</p> |
|                             | Side  |   |
| Operating Temperature Range |       | -55 to 400 °C  |
| Thickness: c                |       | 200 μm   |

| No. | Standard Part No. | a : Lateral size (mm) | b : Longitudinal size (mm) | Hole number | Hole diameter (φmm) | d : Lateral hole pitch (mm) | e : Longitudinal hole pitch (mm) |
|-----|-------------------|-----------------------|----------------------------|-------------|---------------------|-----------------------------|----------------------------------|
| 1   | EYGS1431ZLAA      | 140                   | 308                        | 12          | 6                   | 126                         | 290                              |
| 2   | EYGS0925ZLWA      | 85                    | 246                        | 14          | 6                   | 73                          | 234                              |
| 3   | EYGS1419ZLWB      | 136                   | 186                        | 8           | 7.5                 | 124                         | 171                              |
| 4   | EYGS0917ZLWC      | 85                    | 168                        | 10          | 6                   | 73                          | 156                              |
| 5   | EYGS1316ZLAC      | 125                   | 163                        | 8           | 6.1                 | 110                         | 150                              |
| 6   | EYGS1216ZLWD      | 120                   | 160                        | 8           | 6                   | 110                         | 150                              |
| 7   | EYGS1116ZLMA      | 108.8                 | 158                        | 8           | 6                   | 92.75                       | 144                              |
| 8   | EYGS1315ZLGA      | 129.5                 | 150                        | 8           | 7                   | 118.5                       | 137.5                            |
| 9   | EYGS1314ZLWE      | 126                   | 136                        | 6           | 7.5                 | 114                         | 124                              |
| 10  | EYGS1014ZLAD      | 97.8                  | 138                        | 4           | 6.8                 | 86                          | 127                              |
| 11  | EYGS0714ZLAE      | 70                    | 138                        | 4           | 5.7                 | 57                          | 128                              |
| 12  | EYGS0714ZLAF      | 69                    | 136                        | 4           | 7.2                 | 57                          | 124                              |
| 13  | EYGS1113ZLMB      | 106                   | 132                        | 4           | 5.7                 | 95                          | 121                              |
| 14  | EYGS1313ZLGB      | 128                   | 128                        | 4           | 6.7                 | 110                         | 110                              |
| 15  | EYGS0713ZLAG      | 66                    | 126                        | 4           | 5.7                 | 50                          | 116                              |
| 16  | EYGS0813ZLMD      | 71                    | 123                        | 2           | 4.7                 | Center                      | 116                              |
| 17  | EYGS1212ZLGC      | 120                   | 120                        | 4           | 5.7                 | 110                         | 110                              |
| 18  | EYGS0912ZLGD      | 88                    | 120                        | 4           | 5.7                 | 78                          | 110                              |
| 19  | EYGS0612ZLWF      | 60                    | 120                        | 4           | 5.7                 | 50                          | 110                              |
| 20  | EYGS0512ZLGE      | 53                    | 118                        | 2           | 5.7                 | Center                      | 106                              |
| 21  | EYGS0811ZLGH      | 80                    | 113                        | 4           | 5.7                 | 70                          | 103                              |
| 22  | EYGS0811ZLWG      | 78                    | 108                        | 4           | 6.7                 | 62                          | 93                               |
| 23  | EYGS0611ZLWH      | 60                    | 106                        | 4           | 6.7                 | 48                          | 93                               |
| 24  | EYGS0411ZLWJ      | 43                    | 105.5                      | 2           | 5.7                 | Center                      | 93                               |
| 25  | EYGS0610ZLAH      | 59.4                  | 104.4                      | 4           | 6.7                 | 48                          | 93                               |
| 26  | EYGS0410ZLAJ      | 43                    | 102.8                      | 2           | 5.7                 | Center                      | 93                               |
| 27  | EYGS1010ZLME      | 98                    | 98                         | 4           | 6.7                 | 87                          | 87                               |



| No. | Standard Part No. | a : Lateral size (mm) | b : Longitudinal size (mm) | Hole number | Hole diameter (φmm) | d : Lateral hole pitch (mm) | e : Longitudinal hole pitch (mm) |
|-----|-------------------|-----------------------|----------------------------|-------------|---------------------|-----------------------------|----------------------------------|
| 28  | EYGS0409ZLGJ      | 44                    | 93                         | 2           | 6.7                 | Center                      | 80                               |
| 29  | EYGS0509ZLGK      | 46                    | 92                         | 2           | 6.7                 | Center                      | 80                               |
| 30  | EYGS0309ZLMF      | 32                    | 92                         | 2           | 6.7                 | Center                      | 80                               |
| 31  | EYGS0409ZLMG      | 41                    | 88                         | 2           | 5.7                 | Center                      | 80                               |
| 32  | EYGS0309ZLAK      | 29.5                  | 89.5                       | 2           | 6.6                 | Center                      | 80                               |
| 33  | EYGS0509ZLMH      | 51                    | 86                         | 2           | 4.7                 | –                           | 80                               |
| 34  | EYGS0508ZLMJ      | 46.2                  | 83                         | 2           | 4.7                 | –                           | 77                               |
| 35  | EYGS0608ZLMK      | 55                    | 78                         | 2           | 4.5                 | Center                      | 40                               |
| 36  | EYGS0607ZLGL      | 58                    | 69.7                       | 4           | 5.7                 | 50                          | 62                               |
| 37  | EYGS0507ZLML      | 45.3                  | 66                         | 2           | 4.7                 | –                           | 60                               |
| 38  | EYGS0407ZLAL      | 40                    | 65.5                       | 1           | 7.7                 | Center                      | Center                           |
| 39  | EYGS0506ZLMM      | 48                    | 55                         | 1           | 4.5                 | Center                      | Center                           |
| 40  | EYGS0404ZLMP      | 36                    | 38                         | 1           | 4.5                 | Center                      | Center                           |
| 41  | EYGS1018ZLSA      | 104.5                 | 182.5                      | 8           | 7                   | 93                          | 171                              |
| 42  | EYGS1516ZLSB      | 148                   | 158                        | 8           | 5                   | 137                         | 150                              |
| 43  | EYGS1116ZLSC      | 112                   | 158                        | 8           | 5                   | 101                         | 150                              |
| 44  | EYGS0715ZLSD      | 67                    | 153                        | 4           | 5.6                 | 57                          | 143                              |
| 45  | EYGS0613ZLSE      | 61                    | 127.5                      | 4           | 5.6                 | 50                          | 116                              |
| 46  | EYGS0612ZLSF      | 63.3                  | 124                        | 4           | 5.6                 | 50                          | 110                              |
| 47  | EYGS0612ZLSG      | 61.5                  | 124                        | 4           | 5.6                 | 50                          | 110                              |
| 48  | EYGS1012ZLSH      | 104.5                 | 121                        | 4           | 6.7                 | 93                          | 109.5                            |
| 49  | EYGS0410ZLSJ      | 43                    | 103                        | 2           | 5.7                 | Center                      | 93                               |
| 50  | EYGS0609ZLSK      | 61.5                  | 91                         | 4           | 5.6                 | 50                          | 77                               |
| 51  | EYGS0606ZLSL      | 58                    | 61.5                       | 2           | 5.6                 | 44                          | 50                               |
| 52  | EYGS0305ZLSM      | 27                    | 51                         | 1           | 4.6                 | Center                      | Center                           |
| 53  | EYGS0204ZLSN      | 24                    | 36.5                       | 1           | 4.6                 | Center                      | Center                           |
| 54  | EYGS0303ZLSP      | 29                    | 32                         | 1           | 4.5                 | Center                      | Center                           |
| 55  | EYGS0911ZLDA      | 92                    | 109                        | 4           | 6                   | 78                          | 93                               |
| 56  | EYGS1014ZLDB      | 98                    | 138                        | 4           | 6.7                 | 86                          | 127                              |

## Precautions on the whole

- Do not use the products beyond the descriptions in this catalog.
- This catalog guarantees the quality of the products as individual components.  
Before you use the products, please make sure to check and evaluate the products in the circumstance where they are installed in your product.
- This product was designed and manufactured for standard applications such as general electronics devices, office equipment, information and communications equipment, measuring instruments, household appliances and audio-video equipment.  
For applications in which special quality and reliability are required, or if the failure or malfunction of the products may directly jeopardize life or cause threat of personal injury (such as for aircraft and aerospace equipment, traffic and transport equipment, combustion equipment, medical equipment, accident prevention and anti-theft devices, and safety equipment), please be sure to consult with our sales representative in advance and to exchange product catalog which conform to such applications.

## Safety and Design considerations

- We are trying to improve the quality and the reliability, but the durability differs depending on the use environment and the use conditions. On use, be sure to confirm the actual product under the actual use conditions.
- Install the following systems for a failsafe design to ensure safety if these products are to be used in equipment where a defect in these products may cause the loss of human life or other significant damage, such as damage to vehicles (automobile, train, vessel), traffic lights, medical equipment, aerospace equipment, electric heating appliances, combustion/ gas equipment, rotating equipment, and disaster/crime prevention equipment.
  - The system is equipped with a protection circuit and protection device.
  - The system is equipped with a redundant circuit or other system to prevent an unsafe status in the event of a single fault.
  - The system is equipped with an arresting the spread of fire or preventing glitch.
- When a dogma shall be occurred about safety for this product, be sure to inform us rapidly, operate your technical examination.
- The temperature of this product at the time of use changes depending on mounting conditions and usage conditions, therefore, please confirm that the temperature of this product is the specified temperature after mounting it.
- This product does not take the use under the following special environments into consideration. Accordingly, the use in the following special environments, and such environmental conditions may affect the performance of the product; prior to use, verify the performance, reliability, etc. thoroughly.
  - 1) Use in liquids such as water, oil, chemical, and organic solvent.
  - 2) Use under direct sunlight, in outdoor or in dusty atmospheres.
  - 3) Use in places full of corrosive gases such as sea breeze, C<sub>12</sub>, H<sub>2</sub>S, NH<sub>3</sub>, SO<sub>2</sub>, and NO<sub>x</sub>.
  - 4) Use the product in a contaminated state.
  - 5) Use in acid.
  - 6) Use outside the range defined by the operating temperature range.
  - 7) Use under reduced pressure or vacuum.

## Precaution of installation

- Do not reuse this product after removal from the mounting board.
- Do not drop this product on the floor. If this product is dropped, it can be damaged mechanically. Avoid using the dropped product.
- This product is soft, do not rub or touch it with rough materials to avoid scratching it.
- Lines or folds in this product may affect thermal conductivity.
- Never touch a this product during use because it may be extremely hot.
- Use protective materials when handling and/or applying this product, do not use items with sharp edges as they might tear or puncture this product.
- Do not handle with bare hands as there is a concern about performance degradation.

## Precaution on storage conditions

- Storage period is less than one year after our shipping inspection is completed. Please use within the period.
- If the product is stored in the following environments and conditions, the performance may be badly affected, avoid the storage in the following environments.
  - (1) Storage in places full of corrosive gases such as sea breeze, Cl<sub>2</sub>, H<sub>2</sub>S, NH<sub>3</sub>, SO<sub>2</sub>, and NO<sub>x</sub>.
  - (2) Storage in places exposed to ultraviolet light.
    - \*Recommended storage in the dark.
  - (3) Store at a temperature outside the storage temperature range specified by this catalog.
- In the case of a product configuration that assumes bonding, please use after checking the adhesiveness of the product when the storage period is over.

## Precaution specific to this product

- This product has conductivity. If required, This product should be provided insulation.
- This product can not guarantee the insulation because there is a concern for powder falling off of conductive materials.
- Thermal conductivity is dependent on the way it is used. Test the adaptability of the product to your application before use.

## Applicable laws and regulations, others

- No ODCs or other ozone-depleting substances which are subject to regulation under the Montreal Protocol are used in our manufacturing processes, including in the manufacture of this product.
- This product complies with the RoHS Directive (Restriction of the use of certain Hazardous Substances in electrical and electronic equipment (DIRECTIVE 2011/65/EU and (EU)2015/863) .
- All the materials used in this part are registered material under the Law Concerning the Examination and Regulation of Manufactures etc. of Chemical substances.
- If you need the notice by letter of "A preliminary judgment on the Laws of Japan foreign exchange and Foreign Trade control", be sure to let us know.
- These products are not dangerous goods on the transportation as identified by UN(United Nations) numbers or UN classification.
- As to the disposal of the module, check the method of disposal in each country or region where the modules are incorporated in your products to be used.
- The technical information in this catalog provides examples of our products typical operations and application circuits. We do not guarantee the non-infringement of third party's intellectual property rights and we do not grant any license, right, or interest in our intellectual property.

### CAUTION AND WARNING

1. The electronic components contained in this catalog are designed and produced for use in home electric appliances, office equipment, information equipment, communications equipment, and other general purpose electronic devices.  
Before use of any of these components for equipment that requires a high degree of safety, such as medical instruments, aerospace equipment, disaster-prevention equipment, security equipment, vehicles (automobile, train, vessel), please be sure to contact our sales representative corporation.
2. When applying one of these components for equipment requiring a high degree of safety, no matter what sort of application it might be, be sure to install a protective circuit or redundancy arrangement to enhance the safety of your equipment. In addition, please carry out the safety test on your own responsibility.
3. When using our products, no matter what sort of equipment they might be used for, be sure to make a written agreement on the specifications with us in advance.
4. Technical information contained in this catalog is intended to convey examples of typical performances and or applications and is not intended to make any warranty with respect to the intellectual property rights or any other related rights of our company or any third parties nor grant any license under such rights.
5. In order to export products in this catalog, the exporter may be subject to the export license requirement under the Foreign Exchange and Foreign Trade Law of Japan.
6. No ozone-depleting substances (ODSs) under the Montreal Protocol are used in the manufacturing processes of Automotive & Industrial Systems Company, Panasonic Corporation.

● Please contact

● Factory

Device Solutions Business Division  
Industrial Solutions Company

**Panasonic**<sup>®</sup>

1006 Kadoma, Kadoma City, Osaka 571-8506,  
JAPAN

The information in this catalog is valid as of December 2019.