ANTENNA DIVERSITY WITH Si4x6X

1. Introduction

This document describes the concept of antenna diversity, a technique that can be used to recover radio communication in environments with difficult reception. Antenna diversity can greatly improve performance under multi-path fading conditions. This document also provides real-world measurement examples by demonstrating the improvement that can be achieved with the built-in antenna diversity available using the EZRadioPRO[®] wireless family of RFICs.

While antenna diversity can achieve significant range improvements in wireless communication systems, it is often not implemented due to the added complexity, computation cost, and current consumption that is required to implement the requisite algorithm on the system MCU. EZRadioPRO devices have a built-in antenna diversity algorithm that removes the need for the customer to implement any additional firmware on their system MCU. By incorporating the antenna diversity algorithm into the EZRadioPRO devices directly, customers can achieve the benefits of diversity without the problems of developing and debugging the algorithm, resulting in a more robust solution and a faster time to market.

2. Overview of Antenna Diversity

2.1. Performance Degradation due to Multi-path/Fading

Fading is the phenomena often observed when small movements by either a transmitter or a receiver can lead to large differences in link quality. This happens as an antenna moves in and out of the peaks of a signal.

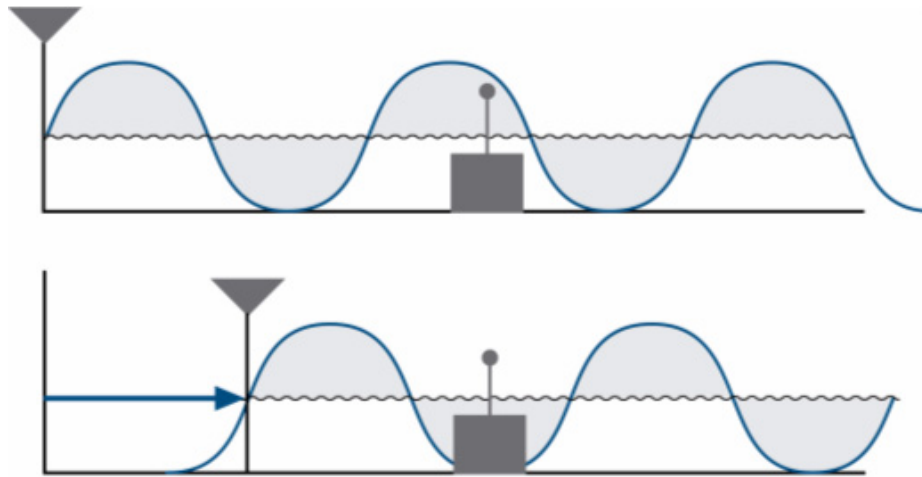

Figure 1. Fading Effects on an Antenna

Multipath expands on this concept. As radio waves are transmitted, they may not be received by the receiver through one signal path, but may come from multiple paths through reflections off other objects such as walls and trees-multipath. The signals received from each of these paths are likely to arrive at slightly different time intervals, meaning slight phase shifts may occur. When these signals combine, they may result in partial or near-total cancellation-fading.

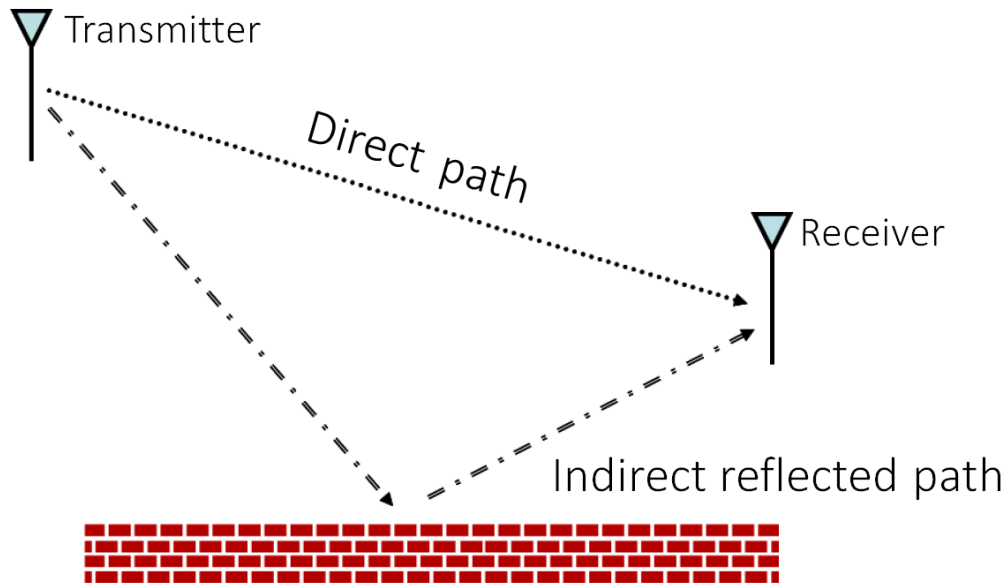

Figure 2. Direct and Indirect RF Pathways

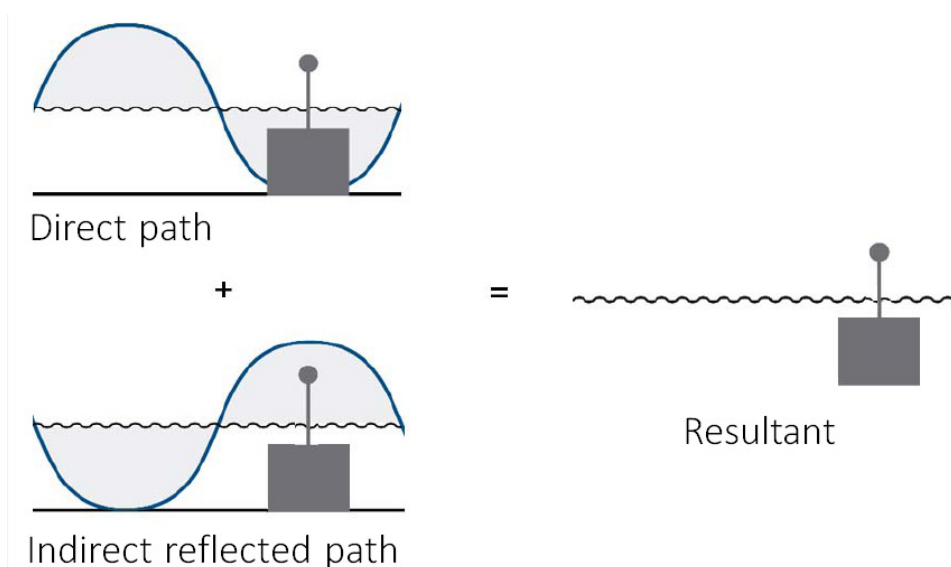

Figure 3. Worst Case RF Fading Effect from Phase Shifts Caused by Multipath

Using a worst case scenario, it can be demonstrated that, should two signals arrive at a receiver with equal amplitudes but exactly 180 degrees out of phase, the receiver will not see any data — this would be 100% signal fading. While not typical, it is not overly unusual for a receiver to receive two such signals with exactly 180 degrees of phase shift, especially at higher operating frequencies. However, it is more likely that a multipath environment will give rise to some other value of phase shift, resulting in more moderate signal fades.

It should be noted that in a multipath environment the propagation attenuation (and thus the range) of the link can be different to the forward and reverse directions, even if the positions of the radios are fixed and the environment is static. This is due to the fact that the incident angles and thus the reflection coefficients are usually different in the up- and down-link.

In real applications, however, the phase and magnitude of the received signal paths are usually changing dynamically due to either the movement of the radios or to the dynamical change of the environment. So the received signal (which is the sum of the received signal paths) is also changing and can be described as a statistical variable. A wide range of literature deals with the calculation of the distribution of the received signal at different environment types.

By knowing the received signal distribution function, in theory, the probability of a deep fading event, which causes data loss, can be calculated. By using a properly configured antenna diversity system, the probability of such deep fades causing link collapse can be reduced.

2.2. Concept of Antenna Diversity

To mitigate the problem of frequency-selective fading due to multi-path propagation, a technique known as antenna diversity can be used. Antenna diversity uses a pair of antennas that are physically separated in location and possibly differ in mounting orientation (i.e., polarization) relative to the radio. Each time the device enters receive (RX) mode, the receive signal strength from each antenna is evaluated. This process is continuously repeated until a valid signal is detected on one of the antennas. The antenna with the strongest received signal strength is then used to receive the remainder of the packet. The same antenna may also be used for transmitting the corresponding transmit (TX) packet. However, it should be noted that there is no guarantee that the fading characteristics of the return TX path match the fading characteristics of the RX path.

Under non-multipath conditions, antenna diversity offers no improvement over a single fixed antenna. In a single-path environment, each time the antenna signal strengths are measured, the antennas would have the same (maximum) signal strength. Hence, the signal strength need only be measured once. However, under real-world conditions the signal strengths observed at the two antennas are generally not equal, due to each antenna

receiving a slightly different set of signal paths. Furthermore, these signal paths are generally not static but vary due to people or objects moving in the vicinity which can cause reflections that change the signal strength in a time-varying manner. Under these conditions, the best antenna to choose will vary with time. This requires that the signal strength at each antenna be continually evaluated to determine the optimal antenna at any given instant.

Antenna diversity is thus a technique that is often used to recover signal integrity in non-static multipath environments. Products that implement antenna diversity quite often also have their antennas mounted at 90 degrees from one another for the purpose of countering the effects of polarization/directionality on the radio link.

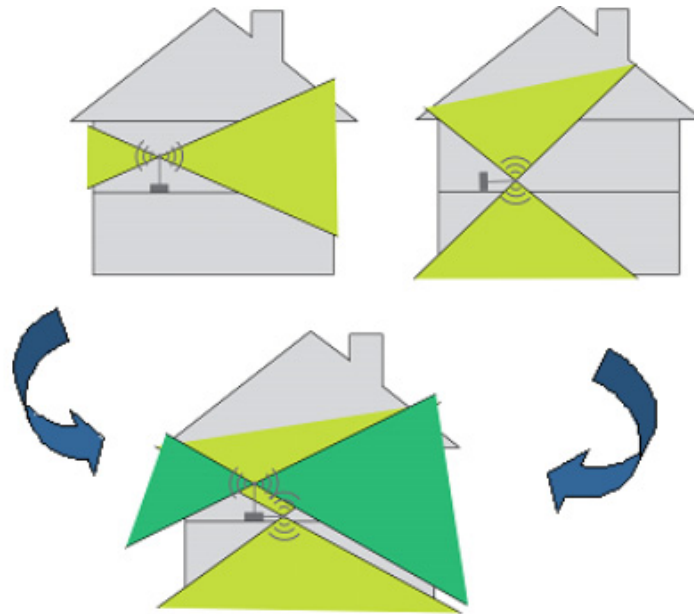

Figure 4. Combating Directionality through the Use of Multiple Antennas

In addition to mounting antennas at 90 degrees relative to one another, antennas in a product that implements antenna diversity have their antennas mounted at a distance of at least $1/4$ wavelength apart. This amount of spatial separation improves the probability that at least one antenna is NOT in a deeply faded signal condition.

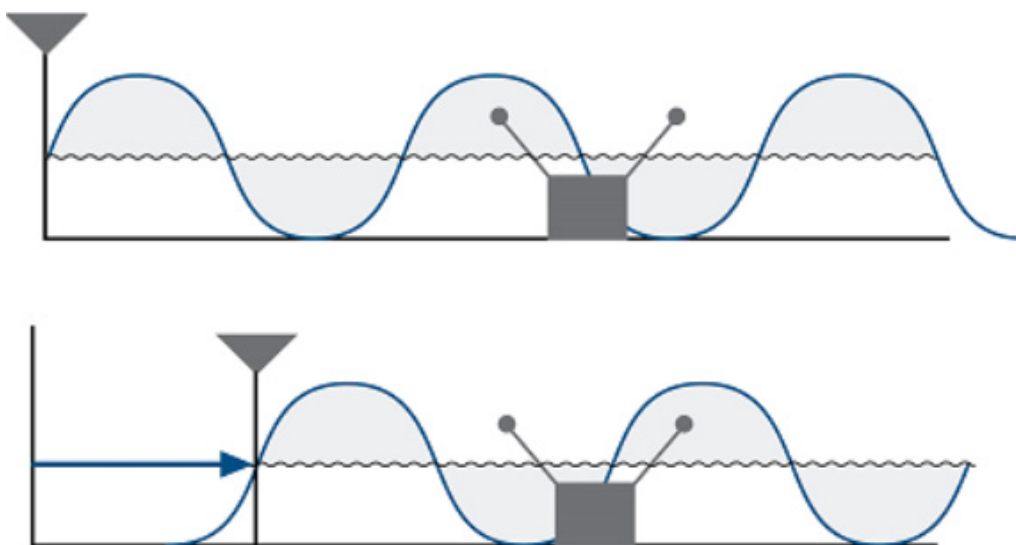

Figure 5. Combating RF Fading with Multiple Antennas

While antenna diversity is useful for recovering signal integrity and retaining link budget in the presence of a multipath environment, many designers opt not to use it because of the disadvantages caused by the increased MCU activity. In most cases, the result of an increased MCU overhead is that the MCU has to remain awake for longer periods of time to evaluate the antenna signals. The increased MCU activity usually leads to a greater specification and a more costly MCU; the MCU also has extended “on-times” that result in shorter battery lives. In other cases, the extra space used to implement a two antenna solution or the additional code expertise required restricts the engineers to a single antenna design.

Implementing an effective antenna diversity algorithm in code on an MCU adds a substantial burden to a design. Many antenna diversity systems are optimized to operate in a synchronized manner between the transmitter and the receiver. The MCU on the receiver maintains a timer that allows the receiver to know when to expect to start receiving data from the transmitter. Under these circumstances the MCU can “wake up” at the appropriate time and immediately start evaluating the signal on both antennas. To evaluate the signal, the MCU would switch between each antenna and evaluate the RSSI levels. In implementations where the receiver does not use a timer, the radio must first reliably detect the start of a packet before evaluating the signal strength of each antenna. This ensures that evaluation of one of the antennas is not accidentally performed on noise (i.e., prior to the arrival of the actual transmit packet). In such a scenario, a deeply-faded antenna may accidentally be selected as the “optimum” choice, simply because the non-faded antenna was never evaluated during a time period when the transmit packet was actually being received.

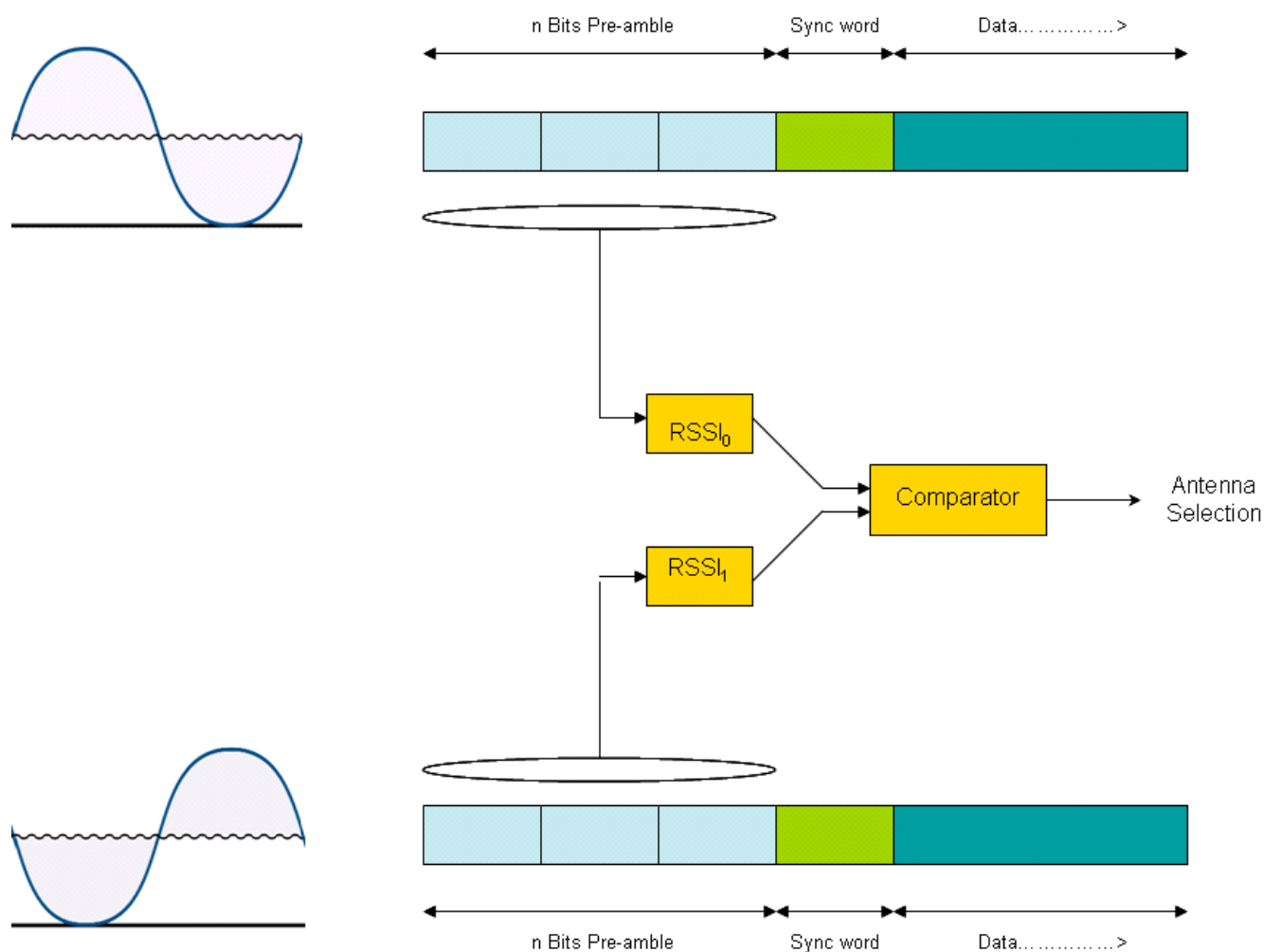

Figure 6. Measuring RSSI Levels to Qualify Antenna Selection

Longer preambles are often used to provide the MCU and its antenna diversity algorithm time to detect and evaluate the signal on each antenna. This longer time period helps to ensure that a true preamble is found (i.e., random noise is not mistaken for a preamble), but shorter preambles are preferred as they reduce radio and MCU on-time, and in turn reduce current consumption in both the transmit and receive sides of a radio link. Engineers often try to find a compromise by adjusting their antenna diversity algorithm to reduce preamble lengths. However, this carries the risk of causing other radio-related issues, as preamble sequences of some minimal length are usually required to provide fast bit clock recovery.

2.3. Implementation of Antenna Diversity Algorithm

The EZRadioPRO antenna diversity algorithm is designed to select the best antenna based on the RSSI values measured at both antennas. In general, the radio has no prior knowledge as to when a valid packet will arrive, as EZRadioPRO does not necessarily rely on time synchronization between the transmitter and receiver ends of the RF link. This problem is solved by periodically switching antennas until arrival of a valid packet has been confirmed. Periodic toggling between antennas is required because, in a variable environment, the radio also has no prior knowledge as to which antenna will prove to be the "better" antenna when the packet arrives.

EZRadioPRO uses a preamble quality detector to determine signal quality and to confirm arrival of a valid packet. The preamble quality detector is configured by setting the `RX_THRESH[6:0]` field in API property `PREAMBLE_CONFIG_STD_1`. The `RX_THRESH[6:0]` field determines the consecutive number of bits of preamble that must be received correctly before the chip issues a `PREAMBLE_VALID` signal.

During the initial search for a valid packet (i.e., the search for the first `PREAMBLE_VALID` signal), a timer is maintained to determine when to periodically toggle between antennas. The default value of this timeout period is 16 bit periods, but is configurable by the `ANWAIT[2:0]` field in API property `MODEM_ANT_DIV_MODE`.

If a bit error occurs prior to receiving the specified consecutive number of preamble bits, the search for `PREAMBLE_VALID` signal starts again. If no valid preamble has been found before timeout (determined by `ANWAIT[2:0]` field), the next antenna is selected and the receiver again tries to find a valid preamble. If the receiver perceives a possible beginning of preamble however, the time that is spent on one antenna will be extended to receive enough preamble bits for making the decision of the presence/absence of the signal. The receiver remains in this search loop until a `PREAMBLE_VALID` signal is observed, indicating arrival of a valid packet. The state diagram of Figure 7 illustrates this process.

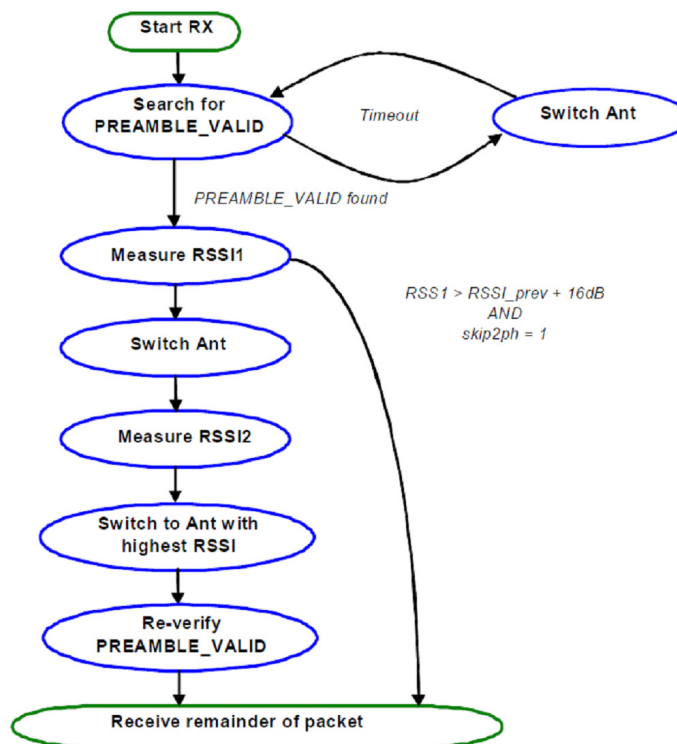

Figure 7. State Diagram of Antenna Diversity Algorithm

If a valid preamble is found, the algorithm proceeds to measuring the RSSI value for that particular antenna. This RSSI value is stored and the receiver then switches to the alternate antenna. The RSSI value on the other antenna is also measured and stored. Based upon the relative values of these two RSSI measurements, a decision is then made to select the optimum antenna (i.e., antenna with the strongest RSSI value) for the remainder of the packet.

The algorithm does not need to re-verify the PREAMBLE_VALID signal on the alternate antenna; it is sufficient to simply measure the RSSI on the alternate antenna. This is because the purpose of acquiring the PREAMBLE_VALID signal is to simply verify the arrival of a valid packet and to aid in acquiring bit clock recovery timing; this step does not need to be repeated on the alternate antenna. Since RSSI measurements are relatively quick, time is saved and the overall length of the preamble can be made shorter, thus extending the battery life. However, the receiver has no prior knowledge whether the signal level on the alternate antenna is stronger or weaker than on the first antenna. There is a possibility that the signal level on the alternate antenna is so weak (i.e., in such a deep fade) that the signal is below the noise floor of the receiver and cannot be received at all. For this reason, the PREAMBLE_VALID signal is re-verified after the final selection of the optimal antenna, which helps to ensure that false preamble detection does not occur. If PREAMBLE_VALID is not re-verified, the diversity algorithm starts again from the beginning.

As a programmable option, the EZRadioPRO chip can be configured to completely skip the evaluation of the alternate antenna in the event that the RSSI level measured on the first antenna is deemed sufficiently high. This functionality is controlled by setting the SKIP2PH bit in API property MODEM_ANT_DIV_MODE. It works by comparing the RSSI value of the antenna on which the PREAMBLE_VALID signal is first detected, with the previous RSSI value of the other antenna. It is evident that this previous RSSI measurement must be taken prior to the arrival of the packet (else PREAMBLE_VALID would be issued earlier), and thus its RSSI value indicates a very weak or no-signal condition. If the current RSSI value on the first antenna which observes a PREAMBLE_VALID signal is greater than 16 dB above the previous RSSI value from the alternate antenna, the signal is deemed sufficiently strong and there is no need to switch to and evaluate the second antenna. If the difference in RSSI value is less than 16 dB, the algorithm proceeds with evaluation of the signal strength on the alternate antenna, as normal. If the SKIP2PH bit is cleared, the antenna diversity algorithm always measures the RSSI value on the

alternate antenna, regardless of signal strength on the initial antenna.

EZRadioPRO thus offers a best-in-class, low-cost and extremely robust radio link upon which designers can rely.

2.4. Benefits of Antenna Diversity

The antenna diversity algorithm provides the greatest improvement in performance when the operating environment is dynamic in terms of signal strength and fading conditions. These conditions normally occur indoors or in crowded outdoor urban environments where the transmitted signal is reflected off of different objects, arriving at the receiver from multiple paths with different phase shifts and signal attenuation. The summation of the signal from these multiple paths results in a time-varying amplitude for the transmission.

The following examples illustrate some different antenna conditions to demonstrate the benefits of antenna diversity.

2.4.1. Correlated Fade on Both Antennas

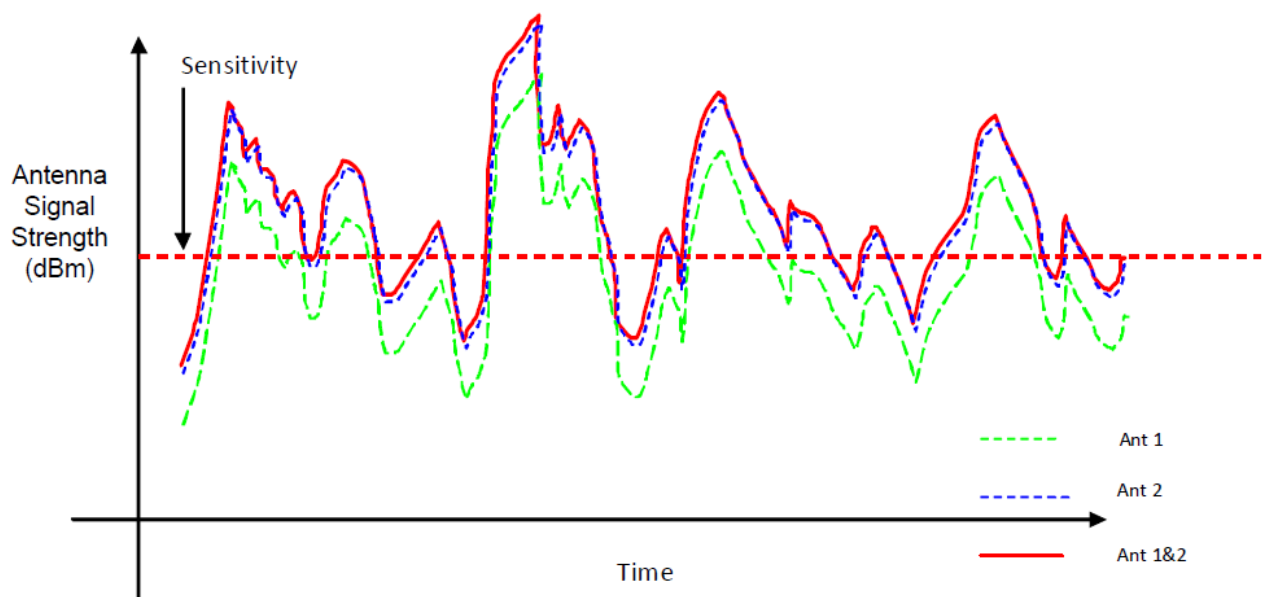

Figure 8. Antenna #1 and Antenna #2 with Correlated Signal Inputs

This example demonstrates a condition where the environment is time-varying, but does not contain any multi-path reflections. The condition demonstrated in Figure 8 could be found in an outdoor open space that is relatively free of any objects that might cause signal reflections; the time-varying nature of the received signal may simply be due to movement of the transmit source. The received signal levels at the two antennas show a consistent fixed gain difference.

Under these conditions, the antenna diversity algorithm will not show improvement in performance compared to the case of statically selecting the optimum antenna (e.g., Antenna #2). In this example, continuously selecting Antenna #2 provides optimal performance because Antenna #2 always has a stronger signal than Antenna #1. The antenna diversity algorithm will always correctly select Antenna #2, and thus will provide no performance improvement over statically selecting Antenna #2. In other words, if the signal strengths at the two antennas are closely correlated, antenna diversity will not improve the performance when compared to statically selecting the single optimum antenna.

2.4.2. Uncorrelated Fade on both Antennas

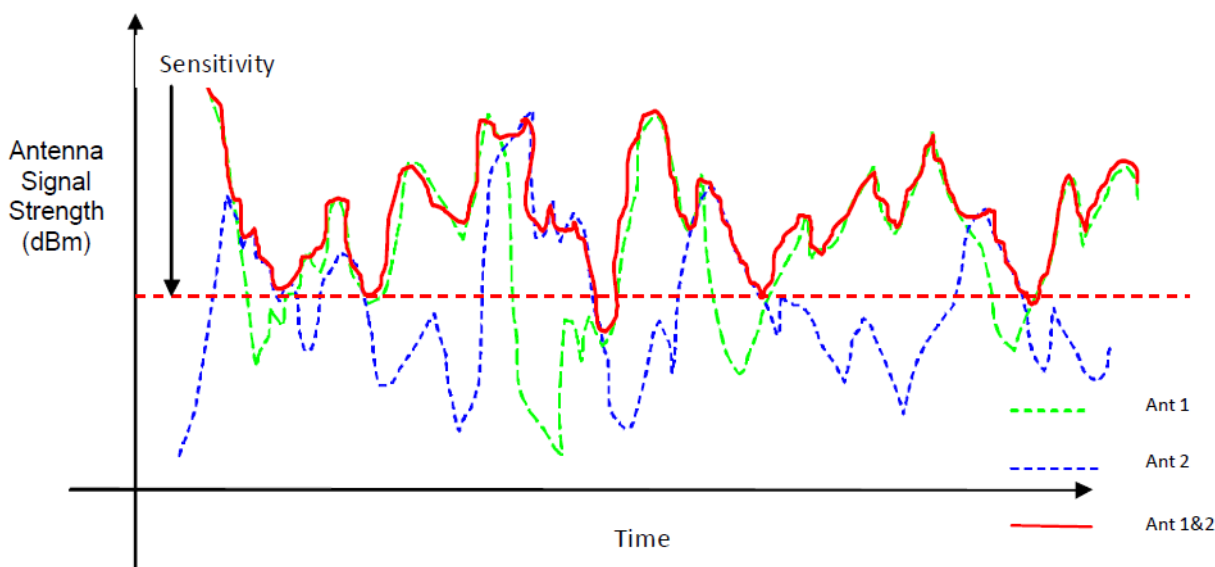

Figure 9. Antenna #1 and Antenna #2 with Uncorrelated Signal Inputs

This example demonstrates a more typical environment where the signal levels received at the two antennas are not identical, due to reflections and movements of people or objects in the environment.

In the figure above, Antenna #1 sometimes receives the stronger signal, while at other times Antenna #2 receives the stronger signal. The antenna diversity algorithm will dynamically select the stronger of the two antennas, resulting in improved performance compared to the case of continuously selecting either Antenna #1 or Antenna #2.

These examples illustrate that if the propagation environment does not exhibit multi-path fades (e.g., an outdoor line-of-sight application free of any reflective objects), no improvement in performance will be observed by enabling antenna diversity. However, most applications require the device to operate under more demanding conditions that will be susceptible to multi-path fading; a definite improvement in performance may be obtained by enabling antenna diversity under such conditions.

3. Range Measurement Setup

To illustrate the benefit of antenna diversity, the link range performance of a board can be measured under real-life environmental conditions, with the antenna diversity functionality selectively disabled and enabled to demonstrate the performance improvement. However, this measurement is not a trivial task. Performing both tests (antenna diversity enabled and disabled) on one single board obviously requires the tests to be run at two separate times; the implication is that the two tests may not be subject to exactly the same fading conditions. As an alternative, the two tests could be performed simultaneously using two separate boards, with antenna diversity enabled on one board and disabled on the other. In this test scenario, differences in the receiver sensitivities could skew the results.

An instrument such as a dual-channel fading simulator can be used to create two signals (for the two antennas) that exhibit a repeatable fading profile with certain statistical properties. However, such an instrument may not be available to (or within the budget of) many users. Furthermore, there is no one single propagation model or fading profile that is appropriate for all users.

As a result, Silicon Labs has settled on the following test approach to verify link range and to demonstrate the benefit of antenna diversity:

1. Rather than searching to find a suitable dynamic multi-path fading environment, such an environment was created by testing in a typical indoor office with the receivers in continuous physical motion. This was accomplished by placing the receiver board(s) on a rotating platform or turntable. This turntable acted as a "fading simulator". The transmitter remained in a fixed location during the testing.
2. Due to uncontrollable factors (such as the random movement of people inside the building), the fading environment varied over time. Thus it was necessary to average multiple measurements to arrive at a statistical evaluation of the performance.
3. Multiple boards were simultaneously mounted on the rotating platform, with each board configured differently with regards to antenna selection and antenna diversity (e.g., fixed selection of Antenna #1 on Board #1, fixed selection of Antenna #2 on Board #2, antenna diversity enabled on Board #3, and so on). The performance of these boards was simultaneously measured, with the implication that each board was subjected to (approximately) the same fading conditions.
4. The test was performed for a sufficient period of time to allow reception of 5,000 packets, and the average packet error rate (PER) recorded. This method allowed comparison of the performance of a board with fixed antenna selection (e.g., Board #1) with the performance of a board with antenna diversity enabled (e.g., Board #3), during a period of time where all boards are assumed to experience a similar fading environment due to their co-location on the same turntable.
5. Steps 3 and 4 were repeated but with a different selection of antennas or antenna diversity configuration on each board. This allowed averaging the performance across each board to eliminate performance differences between the different boards.



Figure 10. Transmitter Setup

In a normal range measurement test, the physical distance between the transmitter and the receiver would be increased until the performance of the link degraded to some reference threshold level (i.e., a desired packet error rate or PER). The distance between transmitter and receiver would be measured for each test configuration and used as the metric for determining which test configuration provided the optimum performance.

However, in this range measurement the physical distance between the transmitter and the receiver remained fixed. The output power level of the transmitter was adjusted up or down (as necessary) to result in link performance equal to the desired PER. This approach proved useful for conducting measurements inside a building with limited available physical space or range. It also allowed for simple determination of the amount of performance improvement obtained with antenna diversity, in units of dB. That is to say, if the output power level of the transmitter was reduced by 6 dB, and a receiver with antenna diversity enabled exhibited the same PER as a non-diversity board receiving the TX signal at full power, the conclusion would be that antenna diversity provided a link range improvement of 6 dB.

An adjustable RF attenuator was used on the transmitter for precise control of the TX RF output level. If both antennas received a very strong signal, or if both antennas received very weak signals (below the RX sensitivity threshold), no improvement in performance with antenna diversity enabled could be observed. This is self-evident: if both antennas were "bad" or both antennas were "good", it made no difference which antenna was selected. It was when only one antenna was near the threshold of RX sensitivity that antenna diversity clearly demonstrated its usefulness. A transmitter with adjustable output level proved useful for creating such a test environment.

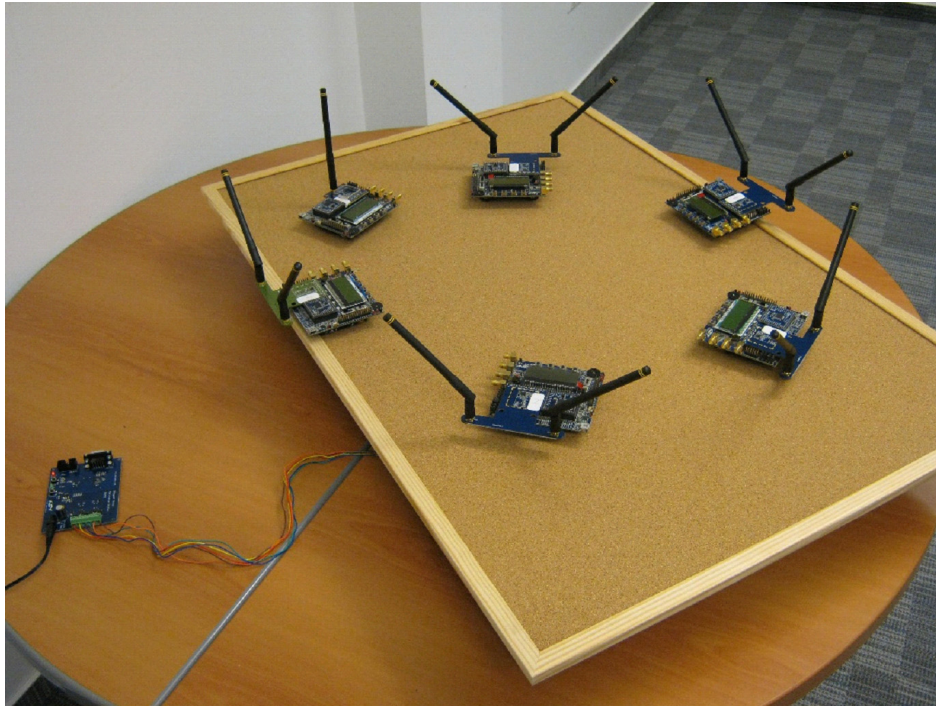

Figure 11. Measurement Setup with Turntable (Artificial Fading Simulator)

Figure 11 illustrates the measurement setup using a turntable. The spin of the turntable was controlled by a rotating motor.

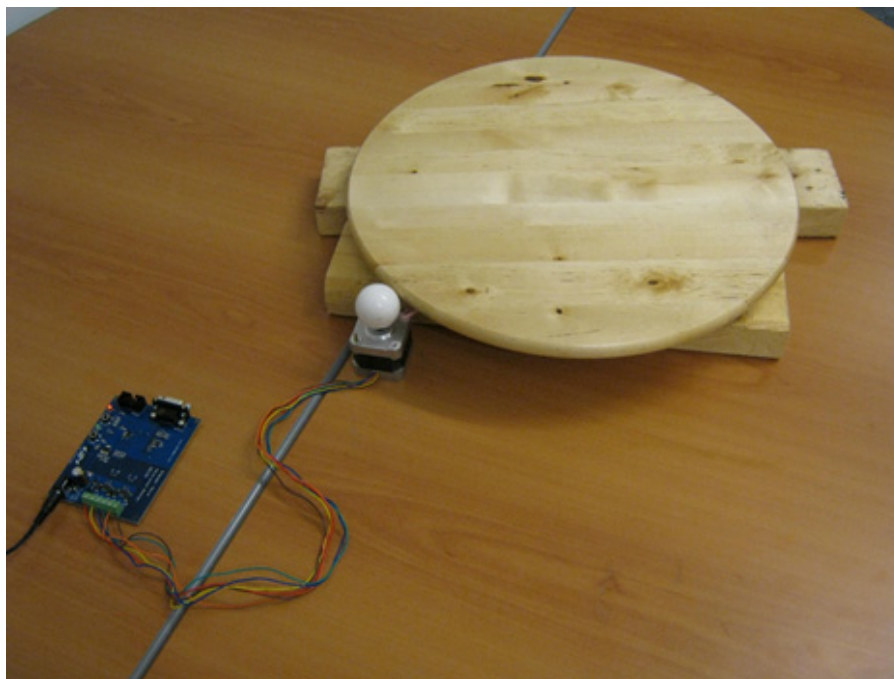

Figure 12. Rotating Motor

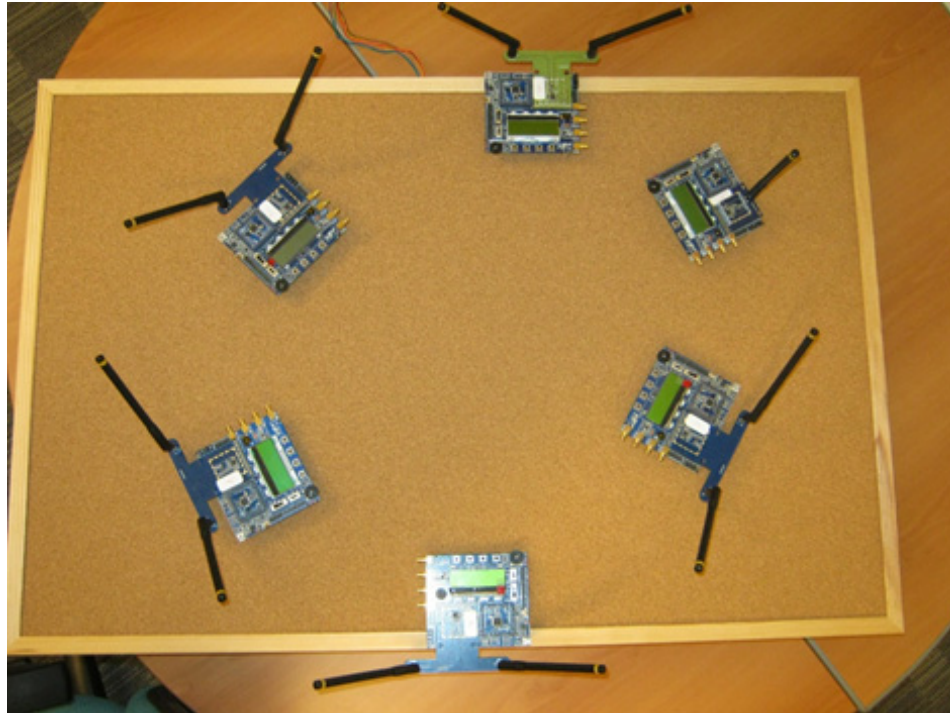

Figure 13. Arrangement of RF Test Boards on the Turntable

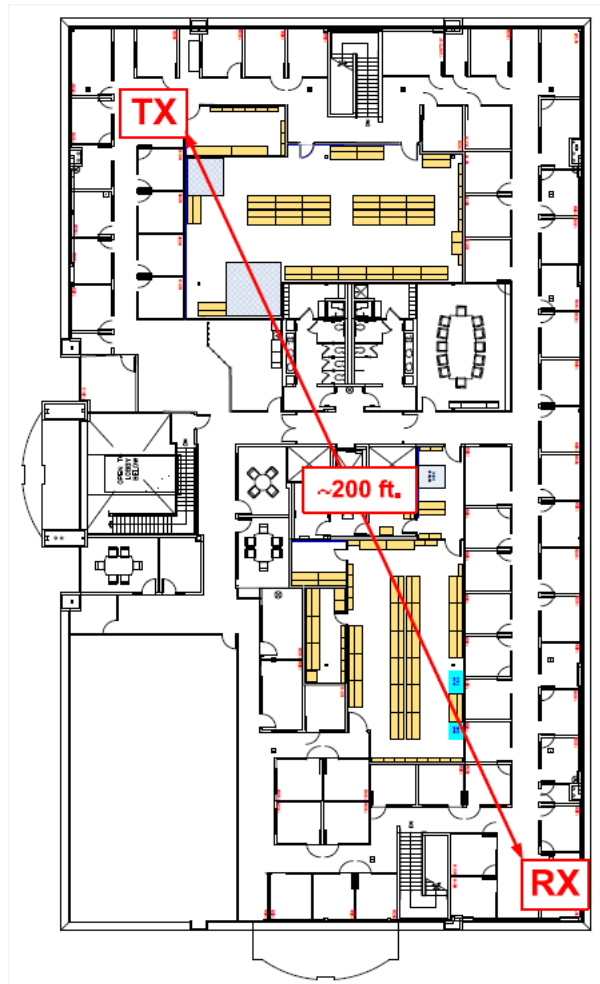

Figure 14. Plan View of the Indoor Office Environment for the Test, TX, and RX Locations Demonstrated

4. Range Measurement Results

4.1. How the Results are Presented and Formatted

Measurements were conducted with the transmitter at a fixed location and the receivers mounted on a rotating turntable located a fixed distance away from the transmitter. Each measurement cycle consisted of six different runs, with each run consisting of 5,000 received packets. Multiple boards (six boards) were mounted simultaneously on the turntable. The antenna selection or the antenna diversity functionality on the boards were configured differently for each run as shown in the example table below:

Table 1. Antenna Configurations for Different Runs

Attenuation at	Antenna Configurations					
TX = x dB	Brd #1	Brd #2	Brd #3	Brd #4	Brd #5	Brd #6
Run 1	Ant Div	Ant Div	Ant Div	Non-Div	Fxd Ant1	Fxd Ant2
Run 2	Ant Div	Ant Div	Ant Div	Non-Div	Fxd Ant2	Fxd Ant1
Run 3	Fxd Ant1	Fxd Ant2	Ant Div	Non-Div	Ant Div	Ant Div
Run 4	Fxd Ant2	Fxd Ant1	Ant Div	Non-Div	Ant Div	Ant Div
Run 5	Ant Div	Ant Div	Fxd Ant1	Non-Div	Ant Div	Ant Div
Run 6	Ant Div	Ant Div	Fxd Ant2	Non-Div	Ant Div	Ant Div

Note: The runs (rows) compare antenna diversity performance with measurements taken at the same time. The boards (columns) compare antenna diversity performance with measurements taken on the same board.

This table is interpreted as follows: For the first run, Board #1, Board #2, and Board #3 were set to enable antenna diversity. Board #4 was a non-diversity card and thus was inherently set to a fixed selection of its single antenna. Board #5 was set to a fixed selection of Antenna #1 (i.e., no antenna diversity), and Board #6 was set to a fixed selection of Antenna #2. For the second run, the antenna configurations were modified to a different combination of settings, interpreted in a similar fashion.

For each run (i.e., horizontal line in the table) the average PER was calculated across those boards with antenna diversity enabled. Also, the average PER was calculated across those boards with fixed antenna selection (i.e., non-diversity mode). This allows comparison of the average PER between diversity and non-diversity boards with measurements taken essentially at the same point in time.

For each board (i.e., vertical column in the table), the average PER was calculated across the runs with the board in antenna diversity mode. The average PER was also calculated across the runs with the board in non-diversity mode. These calculations allowed comparison of the average PER between diversity and non-diversity modes of operation on the same board.

4.2. Interpreting the Results

For each table, the important numbers to compare are the average PER values for each run (horizontal line) and each board (vertical column). In all cases, it may be observed that the PER in antenna diversity mode is less than in non-diversity mode. This difference indicates that antenna diversity provides a consistent improvement in performance.

In order to quantify the improvement in performance from antenna diversity, multiple measurements with different transmit power levels were taken. The goal of these measurements was to quantify how much additional power at the transmitter was required to achieve the same PER in a system with antenna diversity disabled, compared to a system with antenna diversity enabled. For example, demonstrating that it would take an additional 6 dB of TX

output power to achieve the same PER results for a receiver with diversity disabled compared to a receiver with diversity enabled would clearly indicate the benefit of antenna diversity was equal to 6 dB.

To quantify this level of improvement, a series of tests were performed with reduced transmit power. In this reduced power condition, the difference in PER between non-diversity and diversity operation was recorded. For example, there may be an average PER of 15% in non-diversity mode and 4% PER in diversity mode.

The transmit power level was then increased and the measurements repeated. The increase in transmit power level resulted in stronger received signal levels, thus reducing the average PER values for both diversity and non-diversity modes. The transmit power level was further increased until the PER in non-diversity mode dropped to the value of PER in diversity mode previously recorded with reduced transmit power level.

Note: The difference in transmit power level (in dB) required to achieve the same PER in non-diversity mode versus diversity mode is defined as the performance improvement obtained by enabling antenna diversity.

Using this test setup, results for GFSK modulation with different data rates, deviation levels (with modulation index = 1), and with AFC disabled are presented. The used preamble length during these measurements was 64 bit. For preamble length recommendations in case of antenna diversity operation, see section "6. Recommended Preamble Lengths" on page 36.

4.3. Summary of Range Measurement Results

Table 2. Antenna Diversity Performance vs. Date Rate and PER

Data Rate	PER	Antenna Diversity Performance Improvement
9.6 kbps	5%	6 dB
9.6 kbps	8%	5.2 dB
9.6 kbps	10%	4.8 dB
40 kbps	5%	5.8 dB
40 kbps	8%	5.7 dB
40 kbps	10%	5.4 dB
100 kbps	5%	6.1 dB
100 kbps	8%	5.9 dB
100 kbps	10%	5.5 dB
500 kbps	5%	6.6 dB
500 kbps	8%	5.3 dB
500 kbps	10%	4.9 dB

The results of Table 2 are estimations based on the curves of Figures 15-18. This table shows that at a given data rate, as the packet error rate decreases (i.e., more packets are received correctly), the improvement achieved by the application of antenna diversity becomes larger.

4.4. Measurement Results for 100 kbps Data Rate, 50 kHz Deviation

Measured results for the case of 100 kbps data rate with ± 50 kHz deviation (2GFSK, AFC disabled) are presented in this section. The transmitter was initially set to a power level that was recorded as the reference TX power level. The average PER across all runs using antenna diversity was 9.46%, compared with an average PER of 24.81% across all non-diversity runs.

Reference TX Power Level	RX Brd #1	RX Brd #2	RX Brd #3	RX Brd #4	RX Brd #5	RX Brd #6	Time Avg of Non-Div Boards	Time Avg of Div Boards
Ant. Mode selection for Run #1	AntDiv	AntDiv	AntDiv	NonDiv	Fxd 1	Fxd 2		
Run #1: PER over 5k Packets	13,70%	16,00%	6,30%	20,50%	33,60%	30,60%	28,23%	12,00%
Ant. Mode selection for Run #2	AntDiv	AntDiv	AntDiv	NonDiv	Fxd 2	Fxd 1		
Run #2: PER over 5k Packets	9,40%	12,70%	10,70%	13,70%	30,60%	29,30%	24,53%	10,93%
Ant. Mode selection for Run #3	Fxd 1	Fxd 2	AntDiv	NonDiv	AntDiv	AntDiv		
Run #3: PER over 5k Packets	26,50%	27,40%	8,40%	8,20%	12,40%	7,40%	20,70%	9,40%
Ant. Mode selection for Run #4	Fxd 2	Fxd 1	AntDiv	NonDiv	AntDiv	AntDiv		
Run #4: PER over 5k Packets	26,00%	28,30%	4,90%	20,40%	10,20%	6,40%	24,90%	7,17%
Ant. Mode selection for Run #5	AntDiv	AntDiv	Fxd 1	NonDiv	AntDiv	AntDiv		
Run #5: PER over 5k Packets	9,60%	7,80%	11,50%	14,70%	8,10%	7,40%	13,10%	8,23%
Ant. Mode selection for Run #6	AntDiv	AntDiv	Fxd 2	NonDiv	AntDiv	AntDiv		
Run #6: PER over 5k Packets	6,30%	11,80%	23,20%	14,50%	11,30%	8,30%	18,85%	9,43%
Board Avg of Non-Diversity Runs	26,25%	27,85%	17,35%	15,33%	32,10%	29,95%		
Board Avg of Diversity Runs	9,75%	12,08%	7,58%	(N/A)	10,50%	7,38%		
Total Board Avg of Non-Diversity Runs	24,81%							
Total Board Avg of Diversity Runs	9,46%							

The TX output power was next increased in an attempt to reduce the non-diversity PER to (approximately) 9.46%. In this next test, the power level of the transmitter was increased by 2 dB and the measurements repeated. Note that the non-diversity PER measurement decreased to 17.96%, which is still above the PER target of 9.46%.

Reference TX Power Level + 2 dB	RX Brd #1	RX Brd #2	RX Brd #3	RX Brd #4	RX Brd #5	RX Brd #6	Time Avg of Non-Div Boards	Time Avg of Div Boards
Ant. Mode selection for Run #1	AntDiv	AntDiv	AntDiv	NonDiv	Fxd 1	Fxd 2		
Run #1: PER over 5k Packets	8,40%	7,90%	4,30%	10,40%	22,00%	23,70%	18,70%	6,87%
Ant. Mode selection for Run #2	AntDiv	AntDiv	AntDiv	NonDiv	Fxd 2	Fxd 1		
Run #2: PER over 5k Packets	5,40%	5,10%	3,80%	10,50%	22,30%	21,90%	18,23%	4,77%
Ant. Mode selection for Run #3	Fxd 1	Fxd 2	AntDiv	NonDiv	AntDiv	AntDiv		
Run #3: PER over 5k Packets	19,90%	20,10%	2,00%	7,80%	5,10%	3,70%	15,93%	3,60%
Ant. Mode selection for Run #4	Fxd 2	Fxd 1	AntDiv	NonDiv	AntDiv	AntDiv		
Run #4: PER over 5k Packets	14,30%	23,00%	3,50%	12,80%	6,20%	3,30%	16,70%	4,33%
Ant. Mode selection for Run #5	AntDiv	AntDiv	Fxd 1	NonDiv	AntDiv	AntDiv		
Run #5: PER over 5k Packets	4,20%	5,10%	9,00%	13,50%	4,80%	4,80%	11,25%	4,73%
Ant. Mode selection for Run #6	AntDiv	AntDiv	Fxd 2	NonDiv	AntDiv	AntDiv		
Run #6: PER over 5k Packets	1,90%	6,30%	17,00%	11,80%	3,80%	2,30%	14,40%	3,58%
Board Avg of Non-Diversity Runs	17,10%	21,55%	13,00%	11,13%	22,15%	22,80%		
Board Avg of Diversity Runs	4,98%	6,10%	3,40%	(N/A)	4,98%	3,53%		
Total Board Avg of Non-Diversity Runs	17,96%							
Total Board Avg of Diversity Runs	4,60%							

The TX power level was further increased by an additional 3 dB (5 dB above the reference TX power level) and the measurements repeated. In this test case the non-diversity PER measurement dropped to 10.73%, still slightly above the PER target of 9.46% from the initial antenna diversity test condition.

Reference TX Power Level + 5 dB	RX Brd #1	RX Brd #2	RX Brd #3	RX Brd #4	RX Brd #5	RX Brd #6	Time Avg of Non-Div Boards	Time Avg of Div Boards
Ant. Mode selection for Run #1	AntDiv	AntDiv	AntDiv	NonDiv	Fxd 1	Fxd 2		
Run #1: PER over 5k Packets	2,60%	2,10%	1,50%	4,40%	14,80%	13,60%	10,93%	2,07%
Ant. Mode selection for Run #2	AntDiv	AntDiv	AntDiv	NonDiv	Fxd 2	Fxd 1		
Run #2: PER over 5k Packets	0,90%	1,30%	0,90%	5,10%	11,90%	14,40%	10,47%	1,03%
Ant. Mode selection for Run #3	Fxd 1	Fxd 2	AntDiv	NonDiv	AntDiv	AntDiv		
Run #3: PER over 5k Packets	12,30%	13,80%	0,20%	4,10%	1,70%	1,50%	10,07%	1,13%
Ant. Mode selection for Run #4	Fxd 2	Fxd 1	AntDiv	NonDiv	AntDiv	AntDiv		
Run #4: PER over 5k Packets	10,40%	9,70%	0,10%	5,70%	2,30%	0,50%	8,60%	0,97%
Ant. Mode selection for Run #5	AntDiv	AntDiv	Fxd 1	NonDiv	AntDiv	AntDiv		
Run #5: PER over 5k Packets	0,40%	1,80%	7,00%	5,50%	1,20%	0,80%	6,25%	1,05%
Ant. Mode selection for Run #6	AntDiv	AntDiv	Fxd 2	NonDiv	AntDiv	AntDiv		
Run #6: PER over 5k Packets	0,20%	2,80%	10,40%	6,50%	0,90%	0,70%	8,45%	1,15%
Board Avg of Non-Diversity Runs	11,35%	11,75%	8,70%	5,22%	13,35%	14,00%		
Board Avg of Diversity Runs	1,03%	2,00%	0,68%	(N/A)	1,53%	0,88%		
Total Board Avg of Non-Diversity Runs	10,73%							
Total Board Avg of Diversity Runs	1,22%							

The TX power level was further increased by an additional 3 dB (8 dB above the reference TX power level) and the measurements repeated. In this test case, the non-diversity PER measurement dropped to 4.82%, which is now below the PER target of 9.46% from the initial antenna diversity test condition. Thus slightly more than a 5 dB increase in TX output power, but less than an 8 dB increase in TX output power, was required to achieve the same level of performance with antenna diversity disabled, compared with antenna diversity enabled.

Reference TX Power Level + 8 dB	RX Brd #1	RX Brd #2	RX Brd #3	RX Brd #4	RX Brd #5	RX Brd #6	Time Avg of Non-Div Boards	Time Avg of Div Boards
Ant. Mode selection for Run #1	AntDiv	AntDiv	AntDiv	NonDiv	Fxd 1	Fxd 2		
Run #1: PER over 5k Packets	0,40%	0,40%	0,00%	3,10%	4,60%	8,90%	5,53%	0,27%
Ant. Mode selection for Run #2	AntDiv	AntDiv	AntDiv	NonDiv	Fxd 2	Fxd 1		
Run #2: PER over 5k Packets	0,20%	0,10%	0,30%	3,00%	6,10%	5,20%	4,77%	0,20%
Ant. Mode selection for Run #3	Fxd 1	Fxd 2	AntDiv	NonDiv	AntDiv	AntDiv		
Run #3: PER over 5k Packets	2,80%	6,20%	0,00%	1,00%	0,70%	0,00%	3,33%	0,23%
Ant. Mode selection for Run #4	Fxd 2	Fxd 1	AntDiv	NonDiv	AntDiv	AntDiv		
Run #4: PER over 5k Packets	4,70%	4,90%	0,00%	3,00%	0,50%	0,30%	4,20%	0,27%
Ant. Mode selection for Run #5	AntDiv	AntDiv	Fxd 1	NonDiv	AntDiv	AntDiv		
Run #5: PER over 5k Packets	0,00%	0,90%	2,70%	3,20%	0,60%	0,40%	2,95%	0,48%
Ant. Mode selection for Run #6	AntDiv	AntDiv	Fxd 2	NonDiv	AntDiv	AntDiv		
Run #6: PER over 5k Packets	0,00%	0,70%	6,60%	2,20%	0,90%	0,60%	4,40%	0,55%
Board Avg of Non-Diversity Runs	3,75%	5,55%	4,65%	2,58%	5,35%	7,05%		
Board Avg of Diversity Runs	0,15%	0,53%	0,08%	(N/A)	0,68%	0,33%		
Total Board Avg of Non-Diversity Runs	4,82%							
Total Board Avg of Diversity Runs	0,35%							

Antenna diversity consistently demonstrated improved performance when compared with non-diversity mode. This observation held true for measurements averaged over time on the same board, as well as for measurements averaged over several different boards.

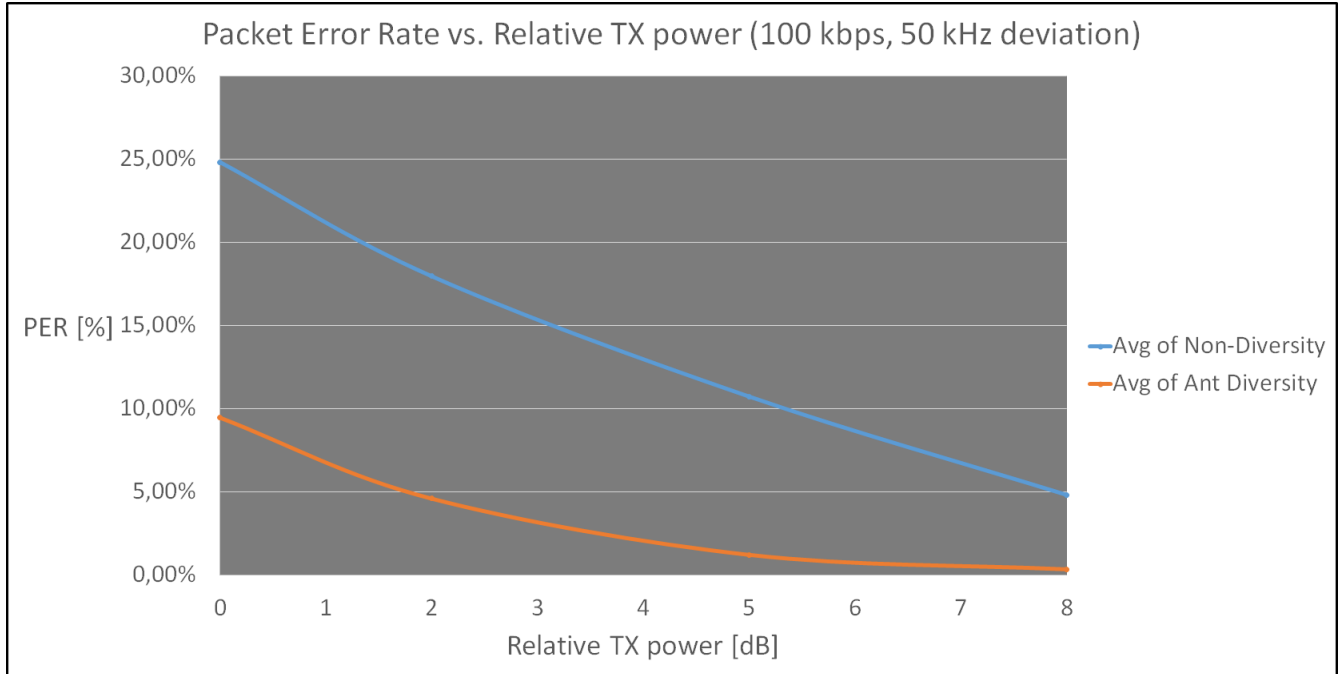

Figure 15. Packet Error Rate vs. Relative TX Power (Data Rate = 100 kbps)

The performance improvement provided by enabling antenna diversity may be more clearly estimated by plotting these measured PER values versus the change in TX output power level, as shown in Figure 15. This graph compares the PER between antenna-diversity and non-diversity modes at different TX output power levels. To achieve the same PER in non-diversity mode versus diversity mode, an additional ~5.6 dB of output power (on average) was required.

4.5. Measurement Results for 40 kbps Data Rate, 20 kHz Deviation

The procedure described in section “4.3. Summary of Range Measurement Results” was repeated at 40 kbps data rate and ± 20 kHz deviation. The results obtained are given in the tables below.

Reference TX Power Level	RX Brd #1	RX Brd #2	RX Brd #3	RX Brd #4	RX Brd #5	RX Brd #6	Time Avg of Non-Div Boards	Time Avg of Div Boards
Ant. Mode selection for Run #1	AntDiv	AntDiv	AntDiv	NonDiv	Fxd 1	Fxd 2		
Run #1: PER over 5k Packets	11,70%	5,90%	5,70%	20,80%	23,00%	26,90%	23,57%	7,77%
Ant. Mode selection for Run #2	AntDiv	AntDiv	AntDiv	NonDiv	Fxd 2	Fxd 1		
Run #2: PER over 5k Packets	5,80%	5,30%	5,80%	17,90%	19,10%	18,10%	18,37%	5,63%
Ant. Mode selection for Run #3	Fxd 1	Fxd 2	AntDiv	NonDiv	AntDiv	AntDiv		
Run #3: PER over 5k Packets	40,60%	17,90%	6,70%	19,50%	10,40%	7,00%	26,00%	8,03%
Ant. Mode selection for Run #4	Fxd 2	Fxd 1	AntDiv	NonDiv	AntDiv	AntDiv		
Run #4: PER over 5k Packets	21,00%	40,50%	6,90%	16,30%	13,00%	7,30%	25,93%	9,07%
Ant. Mode selection for Run #5	AntDiv	AntDiv	Fxd 1	NonDiv	AntDiv	AntDiv		
Run #5: PER over 5k Packets	12,10%	15,30%	26,80%	26,90%	12,00%	5,70%	26,85%	11,28%
Ant. Mode selection for Run #6	AntDiv	AntDiv	Fxd 2	NonDiv	AntDiv	AntDiv		
Run #6: PER over 5k Packets	18,50%	8,40%	38,70%	26,80%	12,70%	6,60%	32,75%	11,55%
Board Avg of Non-Diversity Runs	30,80%	29,20%	32,75%	21,37%	21,05%	22,50%		
Board Avg of Diversity Runs	12,03%	8,73%	6,28%	(N/A)	12,03%	6,65%		
Total Board Avg of Non-Diversity Runs	26,28%							
Total Board Avg of Diversity Runs	9,14%							

Reference TX Power Level + 2 dB	RX Brd #1	RX Brd #2	RX Brd #3	RX Brd #4	RX Brd #5	RX Brd #6	Time Avg of Non-Div Boards	Time Avg of Div Boards
Ant. Mode selection for Run #1	AntDiv	AntDiv	AntDiv	NonDiv	Fxd 1	Fxd 2		
Run #1: PER over 5k Packets	4,00%	5,50%	1,50%	14,90%	10,90%	15,30%	13,70%	3,67%
Ant. Mode selection for Run #2	AntDiv	AntDiv	AntDiv	NonDiv	Fxd 2	Fxd 1		
Run #2: PER over 5k Packets	5,60%	2,10%	2,10%	7,00%	13,50%	11,10%	10,53%	3,27%
Ant. Mode selection for Run #3	Fxd 1	Fxd 2	AntDiv	NonDiv	AntDiv	AntDiv		
Run #3: PER over 5k Packets	31,40%	7,70%	2,60%	12,50%	5,20%	2,50%	17,20%	3,43%
Ant. Mode selection for Run #4	Fxd 2	Fxd 1	AntDiv	NonDiv	AntDiv	AntDiv		
Run #4: PER over 5k Packets	15,10%	28,70%	3,30%	12,80%	8,30%	3,70%	18,87%	5,10%
Ant. Mode selection for Run #5	AntDiv	AntDiv	Fxd 1	NonDiv	AntDiv	AntDiv		
Run #5: PER over 5k Packets	6,50%	10,20%	17,70%	18,10%	9,00%	2,90%	17,90%	7,15%
Ant. Mode selection for Run #6	AntDiv	AntDiv	Fxd 2	NonDiv	AntDiv	AntDiv		
Run #6: PER over 5k Packets	14,10%	2,00%	28,00%	22,30%	8,70%	3,70%	25,15%	7,13%
Board Avg of Non-Diversity Runs	23,25%	18,20%	22,85%	14,60%	12,20%	13,20%		
Board Avg of Diversity Runs	7,55%	4,95%	2,38%	(N/A)	7,80%	3,20%		
Total Board Avg of Non-Diversity Runs	17,38%							
Total Board Avg of Diversity Runs	5,18%							

AN882

Reference TX Power Level + 5 dB	RX Brd #1	RX Brd #2	RX Brd #3	RX Brd #4	RX Brd #5	RX Brd #6	Time Avg of Non-Div Boards	Time Avg of Div Boards
Ant. Mode selection for Run #1	AntDiv	AntDiv	AntDiv	NonDiv	Fxd 1	Fxd 2		
Run #1: PER over 5k Packets	0,70%	0,20%	0,40%	7,80%	8,20%	6,20%	7,40%	0,43%
Ant. Mode selection for Run #2	AntDiv	AntDiv	AntDiv	NonDiv	Fxd 2	Fxd 1		
Run #2: PER over 5k Packets	0,10%	0,00%	0,20%	6,90%	8,90%	7,00%	7,60%	0,10%
Ant. Mode selection for Run #3	Fxd 1	Fxd 2	AntDiv	NonDiv	AntDiv	AntDiv		
Run #3: PER over 5k Packets	19,70%	6,10%	0,30%	7,50%	3,70%	1,40%	11,10%	1,80%
Ant. Mode selection for Run #4	Fxd 2	Fxd 1	AntDiv	NonDiv	AntDiv	AntDiv		
Run #4: PER over 5k Packets	6,10%	19,10%	0,60%	7,80%	3,10%	1,50%	11,00%	1,73%
Ant. Mode selection for Run #5	AntDiv	AntDiv	Fxd 1	NonDiv	AntDiv	AntDiv		
Run #5: PER over 5k Packets	0,30%	3,00%	8,90%	12,40%	1,60%	1,40%	10,65%	1,58%
Ant. Mode selection for Run #6	AntDiv	AntDiv	Fxd 2	NonDiv	AntDiv	AntDiv		
Run #6: PER over 5k Packets	7,20%	0,00%	15,80%	12,20%	4,00%	0,60%	14,00%	2,95%
Board Avg of Non-Diversity Runs	12,90%	12,60%	12,35%	9,10%	8,55%	6,60%		
Board Avg of Diversity Runs	2,08%	0,80%	0,38%	(N/A)	3,10%	1,23%		
Total Board Avg of Non-Diversity Runs	10,35%							
Total Board Avg of Diversity Runs	1,52%							

Reference TX Power Level + 8 dB	RX Brd #1	RX Brd #2	RX Brd #3	RX Brd #4	RX Brd #5	RX Brd #6	Time Avg of Non-Div Boards	Time Avg of Div Boards
Ant. Mode selection for Run #1	AntDiv	AntDiv	AntDiv	NonDiv	Fxd 1	Fxd 2		
Run #1: PER over 5k Packets	0,00%	0,20%	0,00%	2,80%	1,80%	4,80%	3,13%	0,07%
Ant. Mode selection for Run #2	AntDiv	AntDiv	AntDiv	NonDiv	Fxd 2	Fxd 1		
Run #2: PER over 5k Packets	0,10%	0,00%	0,00%	2,70%	2,00%	0,70%	1,80%	0,03%
Ant. Mode selection for Run #3	Fxd 1	Fxd 2	AntDiv	NonDiv	AntDiv	AntDiv		
Run #3: PER over 5k Packets	15,40%	2,40%	0,00%	3,80%	0,10%	0,20%	7,20%	0,10%
Ant. Mode selection for Run #4	Fxd 2	Fxd 1	AntDiv	NonDiv	AntDiv	AntDiv		
Run #4: PER over 5k Packets	2,60%	7,20%	0,80%	5,10%	2,00%	0,70%	4,97%	1,17%
Ant. Mode selection for Run #5	AntDiv	AntDiv	Fxd 1	NonDiv	AntDiv	AntDiv		
Run #5: PER over 5k Packets	0,10%	1,50%	3,30%	6,50%	0,30%	0,30%	4,90%	0,55%
Ant. Mode selection for Run #6	AntDiv	AntDiv	Fxd 2	NonDiv	AntDiv	AntDiv		
Run #6: PER over 5k Packets	1,50%	0,00%	6,70%	6,30%	0,80%	0,00%	6,50%	0,58%
Board Avg of Non-Diversity Runs	9,00%	4,80%	5,00%	4,53%	1,90%	2,75%		
Board Avg of Diversity Runs	0,43%	0,43%	0,20%	(N/A)	0,80%	0,30%		
Total Board Avg of Non-Diversity Runs	4,66%							
Total Board Avg of Diversity Runs	0,43%							

It can be estimated from these measurements that enabling antenna diversity provides approximately 5.5 dB improvement over the non-diversity mode of operation.

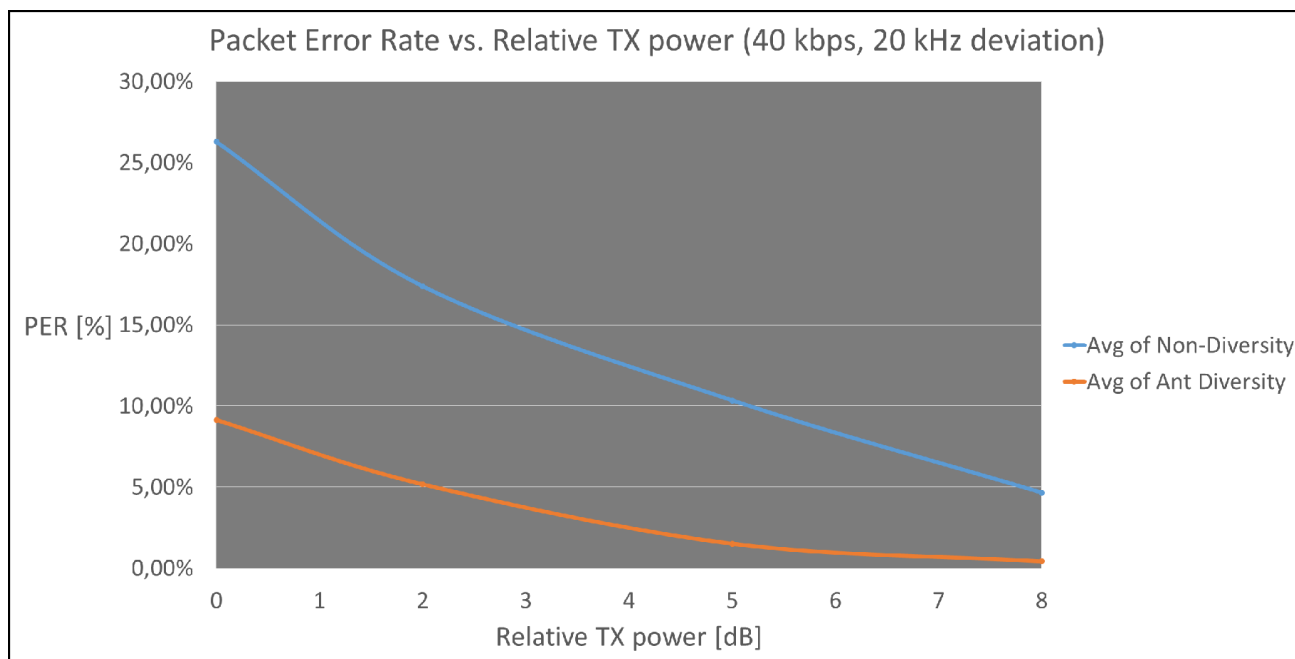

Figure 16. Packet Error Rate vs. Relative TX Power (Data Rate = 40 kbps)

4.6. Measurement Results for 9.6 kbps Data Rate, 4.8 kHz Deviation

The procedure described in section “4.3. Summary of Range Measurement Results” was repeated at 9.6 kbps data rate and ± 4.8 kHz deviation. The results obtained are given in the tables below.

Reference TX Power Level	RX Brd #1	RX Brd #2	RX Brd #3	RX Brd #4	RX Brd #5	RX Brd #6	Time Avg of Non-Div Boards	Time Avg of Div Boards
Ant. Mode selection for Run #1	AntDiv	AntDiv	AntDiv	NonDiv	Fxd 1	Fxd 2		
Run #1: PER over 5k Packets	15,90%	11,50%	4,00%	15,80%	27,50%	23,80%	22,37%	10,47%
Ant. Mode selection for Run #2	AntDiv	AntDiv	AntDiv	NonDiv	Fxd 2	Fxd 1		
Run #2: PER over 5k Packets	14,80%	9,30%	6,50%	16,90%	26,50%	29,70%	24,37%	10,20%
Ant. Mode selection for Run #3	Fxd 1	Fxd 2	AntDiv	NonDiv	AntDiv	AntDiv		
Run #3: PER over 5k Packets	32,40%	26,50%	8,10%	12,20%	6,80%	7,40%	23,70%	7,43%
Ant. Mode selection for Run #4	Fxd 2	Fxd 1	AntDiv	NonDiv	AntDiv	AntDiv		
Run #4: PER over 5k Packets	19,60%	34,70%	3,90%	17,40%	4,80%	10,80%	23,90%	6,50%
Ant. Mode selection for Run #5	AntDiv	AntDiv	Fxd 1	NonDiv	AntDiv	AntDiv		
Run #5: PER over 5k Packets	10,80%	9,70%	21,90%	12,80%	4,90%	6,10%	17,35%	7,88%
Ant. Mode selection for Run #6	AntDiv	AntDiv	Fxd 2	NonDiv	AntDiv	AntDiv		
Run #6: PER over 5k Packets	12,60%	10,00%	19,00%	14,40%	6,30%	8,70%	16,70%	9,40%
Board Avg of Non-Diversity Runs	26,00%	30,60%	20,45%	14,92%	27,00%	26,75%		
Board Avg of Diversity Runs	13,53%	10,13%	5,63%	(N/A)	5,70%	8,25%		
Total Board Avg of Non-Diversity Runs	24,29%							
Total Board Avg of Diversity Runs	8,65%							

AN882

Reference TX Power Level + 2 dB	RX Brd #1	RX Brd #2	RX Brd #3	RX Brd #4	RX Brd #5	RX Brd #6	Time Avg of Non-Div Boards	Time Avg of Div Boards
Ant. Mode selection for Run #1	AntDiv	AntDiv	AntDiv	NonDiv	Fxd 1	Fxd 2		
Run #1: PER over 5k Packets	9,50%	5,60%	1,50%	10,70%	14,80%	18,60%	14,70%	5,53%
Ant. Mode selection for Run #2	AntDiv	AntDiv	AntDiv	NonDiv	Fxd 2	Fxd 1		
Run #2: PER over 5k Packets	6,20%	4,80%	1,30%	8,80%	16,90%	18,40%	14,70%	4,10%
Ant. Mode selection for Run #3	Fxd 1	Fxd 2	AntDiv	NonDiv	AntDiv	AntDiv		
Run #3: PER over 5k Packets	28,10%	14,90%	2,80%	10,80%	2,70%	5,30%	17,93%	3,60%
Ant. Mode selection for Run #4	Fxd 2	Fxd 1	AntDiv	NonDiv	AntDiv	AntDiv		
Run #4: PER over 5k Packets	13,00%	23,00%	1,80%	10,60%	3,50%	6,50%	15,53%	3,93%
Ant. Mode selection for Run #5	AntDiv	AntDiv	Fxd 1	NonDiv	AntDiv	AntDiv		
Run #5: PER over 5k Packets	4,90%	7,30%	15,40%	9,00%	2,90%	2,90%	12,20%	4,50%
Ant. Mode selection for Run #6	AntDiv	AntDiv	Fxd 2	NonDiv	AntDiv	AntDiv		
Run #6: PER over 5k Packets	7,60%	7,60%	18,40%	9,30%	4,50%	5,50%	13,85%	6,30%
Board Avg of Non-Diversity Runs	20,55%	18,95%	16,90%	9,87%	15,85%	18,50%		
Board Avg of Diversity Runs	7,05%	6,33%	1,85%	(N/A)	3,40%	5,05%		
Total Board Avg of Non-Diversity Runs	16,77%							
Total Board Avg of Diversity Runs	4,74%							

Reference TX Power Level + 5 dB	RX Brd #1	RX Brd #2	RX Brd #3	RX Brd #4	RX Brd #5	RX Brd #6	Time Avg of Non-Div Boards	Time Avg of Div Boards
Ant. Mode selection for Run #1	AntDiv	AntDiv	AntDiv	NonDiv	Fxd 1	Fxd 2		
Run #1: PER over 5k Packets	2,70%	1,10%	0,40%	5,40%	11,30%	9,20%	8,63%	1,40%
Ant. Mode selection for Run #2	AntDiv	AntDiv	AntDiv	NonDiv	Fxd 2	Fxd 1		
Run #2: PER over 5k Packets	1,40%	2,20%	0,00%	5,30%	9,50%	8,90%	7,90%	1,20%
Ant. Mode selection for Run #3	Fxd 1	Fxd 2	AntDiv	NonDiv	AntDiv	AntDiv		
Run #3: PER over 5k Packets	14,30%	7,60%	0,10%	7,30%	0,20%	3,20%	9,73%	1,17%
Ant. Mode selection for Run #4	Fxd 2	Fxd 1	AntDiv	NonDiv	AntDiv	AntDiv		
Run #4: PER over 5k Packets	5,10%	7,20%	0,00%	4,40%	1,50%	3,20%	5,57%	1,57%
Ant. Mode selection for Run #5	AntDiv	AntDiv	Fxd 1	NonDiv	AntDiv	AntDiv		
Run #5: PER over 5k Packets	0,70%	3,10%	9,40%	4,70%	1,80%	2,10%	7,05%	1,93%
Ant. Mode selection for Run #6	AntDiv	AntDiv	Fxd 2	NonDiv	AntDiv	AntDiv		
Run #6: PER over 5k Packets	2,10%	5,70%	13,10%	4,90%	1,20%	2,90%	9,00%	2,98%
Board Avg of Non-Diversity Runs	9,70%	7,40%	11,25%	5,33%	10,40%	9,05%		
Board Avg of Diversity Runs	1,73%	3,03%	0,13%	(N/A)	1,18%	2,85%		
Total Board Avg of Non-Diversity Runs	8,86%							
Total Board Avg of Diversity Runs	1,78%							

Reference TX Power Level + 8 dB	RX Brd #1	RX Brd #2	RX Brd #3	RX Brd #4	RX Brd #5	RX Brd #6	Time Avg of Non-Div Boards	Time Avg of Div Boards
Ant. Mode selection for Run #1	AntDiv	AntDiv	AntDiv	NonDiv	Fxd 1	Fxd 2		
Run #1: PER over 5k Packets	1,20%	0,10%	0,00%	3,40%	6,10%	5,00%	4,83%	0,43%
Ant. Mode selection for Run #2	AntDiv	AntDiv	AntDiv	NonDiv	Fxd 2	Fxd 1		
Run #2: PER over 5k Packets	0,30%	0,80%	0,00%	1,90%	4,30%	5,80%	4,00%	0,37%
Ant. Mode selection for Run #3	Fxd 1	Fxd 2	AntDiv	NonDiv	AntDiv	AntDiv		
Run #3: PER over 5k Packets	10,20%	1,70%	0,00%	3,10%	0,00%	1,50%	5,00%	0,50%
Ant. Mode selection for Run #4	Fxd 2	Fxd 1	AntDiv	NonDiv	AntDiv	AntDiv		
Run #4: PER over 5k Packets	4,20%	6,10%	0,00%	3,00%	0,10%	0,80%	4,43%	0,30%
Ant. Mode selection for Run #5	AntDiv	AntDiv	Fxd 1	NonDiv	AntDiv	AntDiv		
Run #5: PER over 5k Packets	0,70%	0,10%	3,60%	2,90%	0,00%	0,30%	3,25%	0,28%
Ant. Mode selection for Run #6	AntDiv	AntDiv	Fxd 2	NonDiv	AntDiv	AntDiv		
Run #6: PER over 5k Packets	0,80%	0,70%	6,30%	3,00%	0,00%	0,80%	4,65%	0,58%
Board Avg of Non-Diversity Runs	7,20%	3,90%	4,95%	2,88%	5,20%	5,40%		
Board Avg of Diversity Runs	0,75%	0,43%	0,00%	(N/A)	0,03%	0,85%		
Total Board Avg of Non-Diversity Runs	4,92%							
Total Board Avg of Diversity Runs	0,41%							

It can be estimated from these measurements that enabling antenna diversity in this environment provides approximately 5.1 dB improvement over the non-diversity mode of operation.

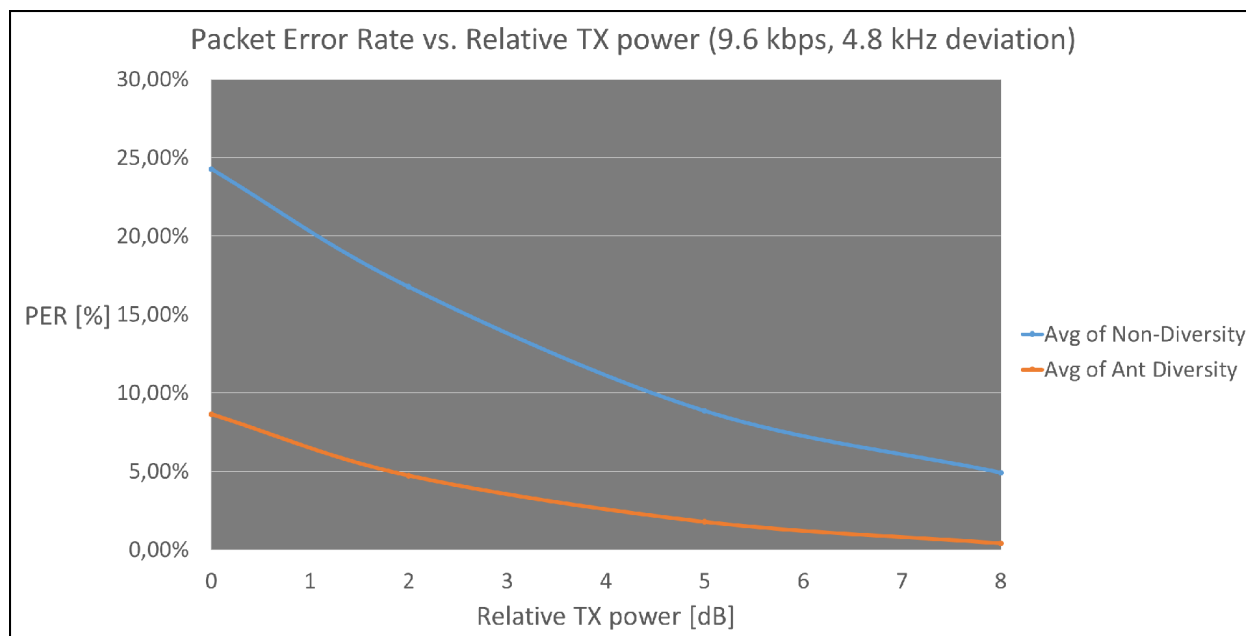

Figure 17. Packet Error Rate vs. Relative TX Power (Data Rate = 9.6 kbps)

4.7. Measurement Results for 500 kbps Data Rate, 250 kHz Deviation

The procedure described in section “4.3. Summary of Range Measurement Results” was repeated at 50 kbps data rate and ± 250 kHz deviation. The results obtained are given in the tables below.

Reference TX Power Level	RX Brd #1	RX Brd #2	RX Brd #3	RX Brd #4	RX Brd #5	RX Brd #6	Time Avg of Non-Div Boards	Time Avg of Div Boards
Ant. Mode selection for Run #1	AntDiv	AntDiv	AntDiv	NonDiv	Fxd 1	Fxd 2		
Run #1: PER over 5k Packets	9,70%	4,20%	6,70%	26,60%	14,60%	36,30%	25,83%	6,87%
Ant. Mode selection for Run #2	AntDiv	AntDiv	AntDiv	NonDiv	Fxd 2	Fxd 1		
Run #2: PER over 5k Packets	8,10%	7,60%	9,20%	34,00%	29,40%	24,60%	29,33%	8,30%
Ant. Mode selection for Run #3	Fxd 1	Fxd 2	AntDiv	NonDiv	AntDiv	AntDiv		
Run #3: PER over 5k Packets	26,50%	20,30%	9,20%	26,60%	12,30%	11,60%	24,47%	11,03%
Ant. Mode selection for Run #4	Fxd 2	Fxd 1	AntDiv	NonDiv	AntDiv	AntDiv		
Run #4: PER over 5k Packets	31,50%	20,30%	12,80%	22,20%	11,20%	11,80%	24,67%	11,93%
Ant. Mode selection for Run #5	AntDiv	AntDiv	Fxd 1	NonDiv	AntDiv	AntDiv		
Run #5: PER over 5k Packets	10,10%	9,60%	23,70%	20,70%	8,20%	8,60%	22,20%	9,13%
Ant. Mode selection for Run #6	AntDiv	AntDiv	Fxd 2	NonDiv	AntDiv	AntDiv		
Run #6: PER over 5k Packets	11,20%	7,70%	39,60%	25,50%	7,70%	8,60%	32,55%	8,80%
Board Avg of Non-Diversity Runs	29,00%	20,30%	31,65%	25,93%	22,00%	30,45%		
Board Avg of Diversity Runs	9,78%	7,28%	9,48%	(N/A)	9,85%	10,15%		
Total Board Avg of Non-Diversity Runs	26,56%							
Total Board Avg of Diversity Runs	9,31%							

Reference TX Power Level + 2 dB	RX Brd #1	RX Brd #2	RX Brd #3	RX Brd #4	RX Brd #5	RX Brd #6	Time Avg of Non-Div Boards	Time Avg of Div Boards
Ant. Mode selection for Run #1	AntDiv	AntDiv	AntDiv	NonDiv	Fxd 1	Fxd 2		
Run #1: PER over 5k Packets	3,70%	1,70%	3,10%	16,40%	8,30%	25,50%	16,73%	2,83%
Ant. Mode selection for Run #2	AntDiv	AntDiv	AntDiv	NonDiv	Fxd 2	Fxd 1		
Run #2: PER over 5k Packets	3,60%	3,60%	2,90%	26,90%	20,40%	14,80%	20,70%	3,37%
Ant. Mode selection for Run #3	Fxd 1	Fxd 2	AntDiv	NonDiv	AntDiv	AntDiv		
Run #3: PER over 5k Packets	20,00%	7,20%	4,30%	19,60%	5,60%	4,50%	15,60%	4,80%
Ant. Mode selection for Run #4	Fxd 2	Fxd 1	AntDiv	NonDiv	AntDiv	AntDiv		
Run #4: PER over 5k Packets	24,80%	15,00%	4,80%	18,00%	6,90%	6,50%	19,27%	6,07%
Ant. Mode selection for Run #5	AntDiv	AntDiv	Fxd 1	NonDiv	AntDiv	AntDiv		
Run #5: PER over 5k Packets	4,60%	3,30%	14,70%	15,80%	4,60%	3,50%	15,25%	4,00%
Ant. Mode selection for Run #6	AntDiv	AntDiv	Fxd 2	NonDiv	AntDiv	AntDiv		
Run #6: PER over 5k Packets	2,20%	2,40%	24,90%	14,40%	2,00%	3,30%	19,65%	2,48%
Board Avg of Non-Diversity Runs	22,40%	11,10%	19,80%	18,52%	14,35%	20,15%		
Board Avg of Diversity Runs	3,53%	2,75%	3,78%	(N/A)	4,78%	4,45%		
Total Board Avg of Non-Diversity Runs	17,72%							
Total Board Avg of Diversity Runs	3,86%							

Reference TX Power Level + 5 dB	RX Brd #1	RX Brd #2	RX Brd #3	RX Brd #4	RX Brd #5	RX Brd #6	Time Avg of Non-Div Boards	Time Avg of Div Boards
Ant. Mode selection for Run #1	AntDiv	AntDiv	AntDiv	NonDiv	Fxd 1	Fxd 2		
Run #1: PER over 5k Packets	0,60%	0,80%	1,00%	7,10%	5,10%	13,60%	8,60%	0,80%
Ant. Mode selection for Run #2	AntDiv	AntDiv	AntDiv	NonDiv	Fxd 2	Fxd 1		
Run #2: PER over 5k Packets	1,30%	0,50%	1,10%	13,70%	7,80%	7,90%	9,80%	0,97%
Ant. Mode selection for Run #3	Fxd 1	Fxd 2	AntDiv	NonDiv	AntDiv	AntDiv		
Run #3: PER over 5k Packets	11,50%	2,70%	0,90%	7,20%	0,90%	1,30%	7,13%	1,03%
Ant. Mode selection for Run #4	Fxd 2	Fxd 1	AntDiv	NonDiv	AntDiv	AntDiv		
Run #4: PER over 5k Packets	15,10%	5,50%	0,90%	9,30%	1,90%	1,00%	9,97%	1,27%
Ant. Mode selection for Run #5	AntDiv	AntDiv	Fxd 1	NonDiv	AntDiv	AntDiv		
Run #5: PER over 5k Packets	0,50%	0,70%	7,70%	10,00%	0,90%	1,00%	8,85%	0,78%
Ant. Mode selection for Run #6	AntDiv	AntDiv	Fxd 2	NonDiv	AntDiv	AntDiv		
Run #6: PER over 5k Packets	0,80%	0,50%	18,00%	5,10%	0,60%	1,10%	11,55%	0,75%
Board Avg of Non-Diversity Runs	13,30%	4,10%	12,85%	8,73%	6,45%	10,75%		
Board Avg of Diversity Runs	0,80%	0,63%	0,98%	(N/A)	1,08%	1,10%		
Total Board Avg of Non-Diversity Runs	9,36%							
Total Board Avg of Diversity Runs	0,92%							

Reference TX Power Level + 8 dB	RX Brd #1	RX Brd #2	RX Brd #3	RX Brd #4	RX Brd #5	RX Brd #6	Time Avg of Non-Div Boards	Time Avg of Div Boards
Ant. Mode selection for Run #1	AntDiv	AntDiv	AntDiv	NonDiv	Fxd 1	Fxd 2		
Run #1: PER over 5k Packets	0,30%	0,10%	0,40%	3,10%	2,60%	11,60%	5,77%	0,27%
Ant. Mode selection for Run #2	AntDiv	AntDiv	AntDiv	NonDiv	Fxd 2	Fxd 1		
Run #2: PER over 5k Packets	0,50%	0,20%	0,50%	5,70%	4,70%	5,50%	5,30%	0,40%
Ant. Mode selection for Run #3	Fxd 1	Fxd 2	AntDiv	NonDiv	AntDiv	AntDiv		
Run #3: PER over 5k Packets	6,60%	1,20%	0,70%	8,50%	0,60%	0,60%	5,43%	0,63%
Ant. Mode selection for Run #4	Fxd 2	Fxd 1	AntDiv	NonDiv	AntDiv	AntDiv		
Run #4: PER over 5k Packets	7,70%	4,60%	0,50%	5,90%	0,70%	0,50%	6,07%	0,57%
Ant. Mode selection for Run #5	AntDiv	AntDiv	Fxd 1	NonDiv	AntDiv	AntDiv		
Run #5: PER over 5k Packets	0,40%	0,30%	3,50%	4,50%	0,30%	0,50%	4,00%	0,38%
Ant. Mode selection for Run #6	AntDiv	AntDiv	Fxd 2	NonDiv	AntDiv	AntDiv		
Run #6: PER over 5k Packets	0,40%	0,10%	9,40%	1,70%	0,20%	0,40%	5,55%	0,28%
Board Avg of Non-Diversity Runs	7,15%	2,90%	6,45%	4,90%	3,65%	8,55%		
Board Avg of Diversity Runs	0,40%	0,18%	0,53%	(N/A)	0,45%	0,50%		
Total Board Avg of Non-Diversity Runs	5,60%							
Total Board Avg of Diversity Runs	0,41%							

It can be estimated from these measurements that enabling antenna diversity in this environment provides approximately 5 dB improvement over the non-diversity mode of operation.

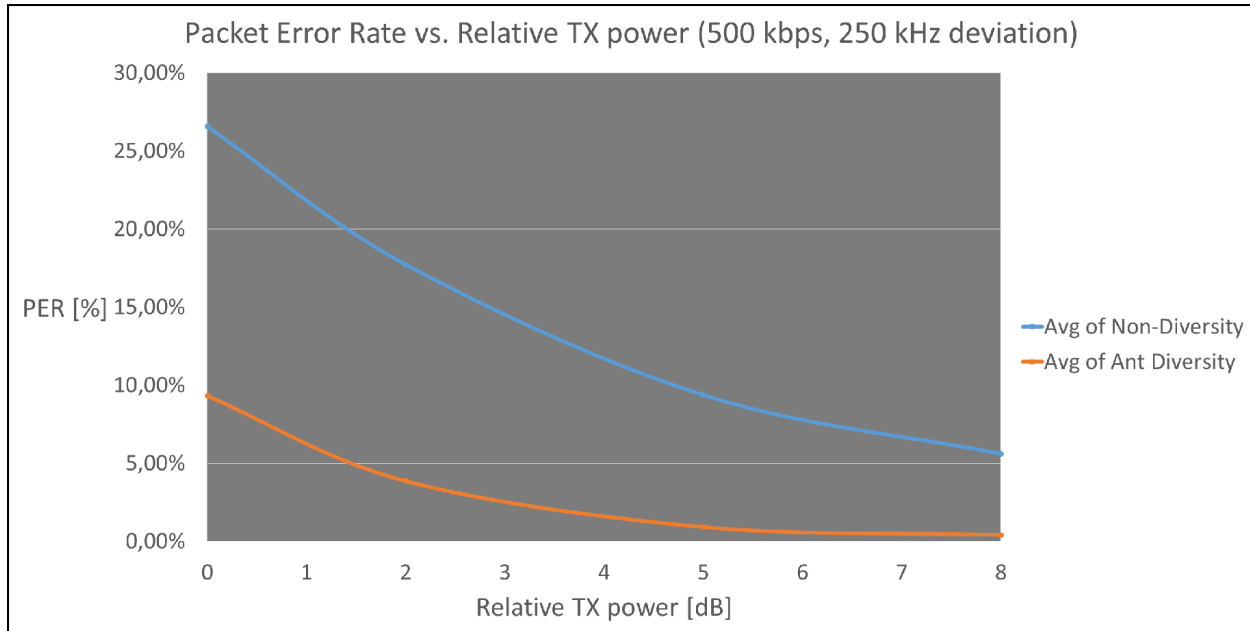

Figure 18. Packet Error Rate vs. Relative TX Power (Data Rate = 500 kbps)

5. Packet Error Rate vs. Relative TX power (Data Rate = 500 kbps)

The measurement results presented in the previous section clearly demonstrate the benefit of antenna diversity when operated in a real-world, dynamic multi-path fading environment. However, it is also useful for the user to be able to create a simple test setup in a lab environment, using commonly-available test equipment, RF Pico Boards, development kits, and Wireless Development Suite (WDS) software. This test setup may be used to visually inspect the various waveforms associated with proper operation of the antenna diversity algorithm such as the antenna diversity switch control signals, PREAMBLE_VALID (PRE_DET), RX_DATA, etc. The purpose of such a test setup is not to quantify the **amount** of performance improvement provided by antenna diversity, but instead is to provide the user with visual confirmation that the antenna diversity algorithm is functional (i.e., the strongest antenna is reliably selected).

5.1. Lab Test Setup and WDS Settings

A typical lab test setup for verification of antenna diversity is shown in Figure 19. An arbitrary waveform generator (ArbGen) is programmed to provide one complete packet of TXDATA (including Preamble, Sync word, and Payload) that is connected to the External FM Modulation input of the signal generator. The RF output of the signal generator is split into two paths by a power splitter. A fixed RF attenuator (e.g., 6 dB) is installed in one path, while an adjustable RF attenuator is installed in the other path. In this fashion, the relative signal level of the two paths may be adjusted over both a positive and negative range. These two signal paths are connected to the two antenna inputs of the antenna diversity RF Pico Board. It should be clearly understood that this test setup does not provide signals that vary in a dynamic (i.e., time-varying) fashion; the relative amplitude of the two signals remains fixed until the user adjusts the setting of the RF attenuator(s).

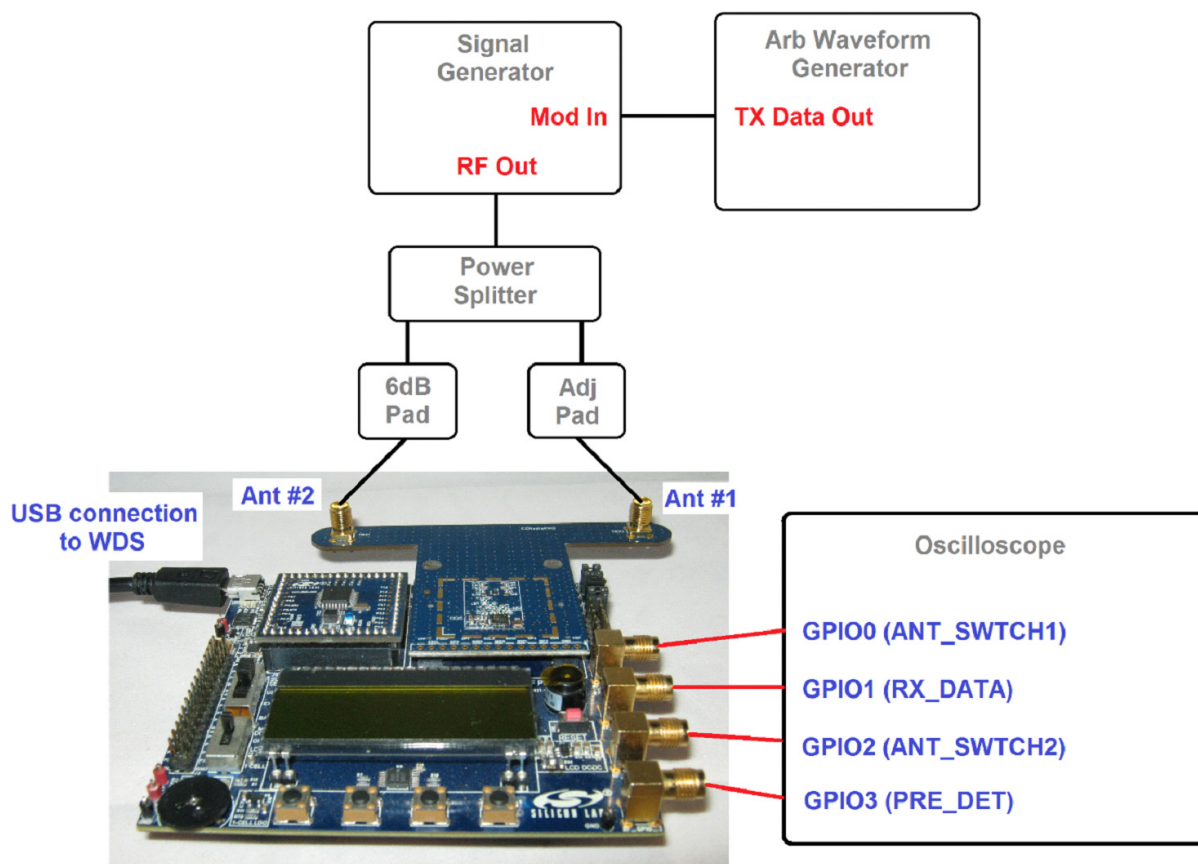

Figure 19. Lab Test Setup for Antenna Diversity

AN882

The Antenna Diversity RF Pico Boards (e.g., 4463CPCE20A915) available from Silicon Labs require the mapping of two GPIO pins on the RFIC as control lines for the antenna diversity switch. These RF Pico Boards are hard-wired to use GPIO0 and GPIO2 as the control lines for the antenna diversity switch, and thus are not available for any other function. This means that only GPIO1 and GPIO3 remain available for output of signals such as RXDATA, PREAMBLE_VALID (PRE_DET), etc. The user **must** ensure that, when operating with RF Pico Boards available from Silicon Labs, the GPIO0 and GPIO2 signals are not accidentally re-defined for any purpose other than control of the antenna diversity switch.

Using Radio Configuration Application menu, Custom packet RX project in WDS, the operation of antenna diversity can be easily demonstrated. When setting GPIOs in WDS, make sure that GPIO0 and GPIO2 are used for control of the RF switch which selects between the antennas (Figure 20).

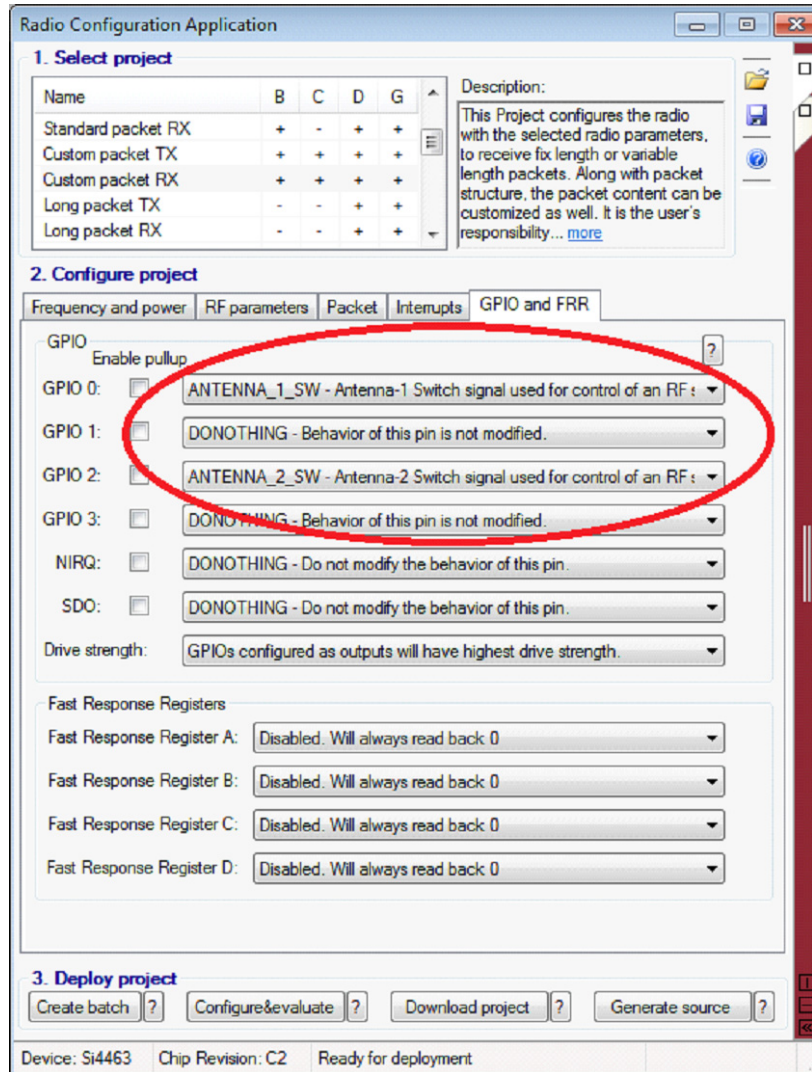

Figure 20. GPIO Settings in WDS

Also, for operation of Antenna Diversity, it is necessary to enable this function at RF parameters (Figure 21).

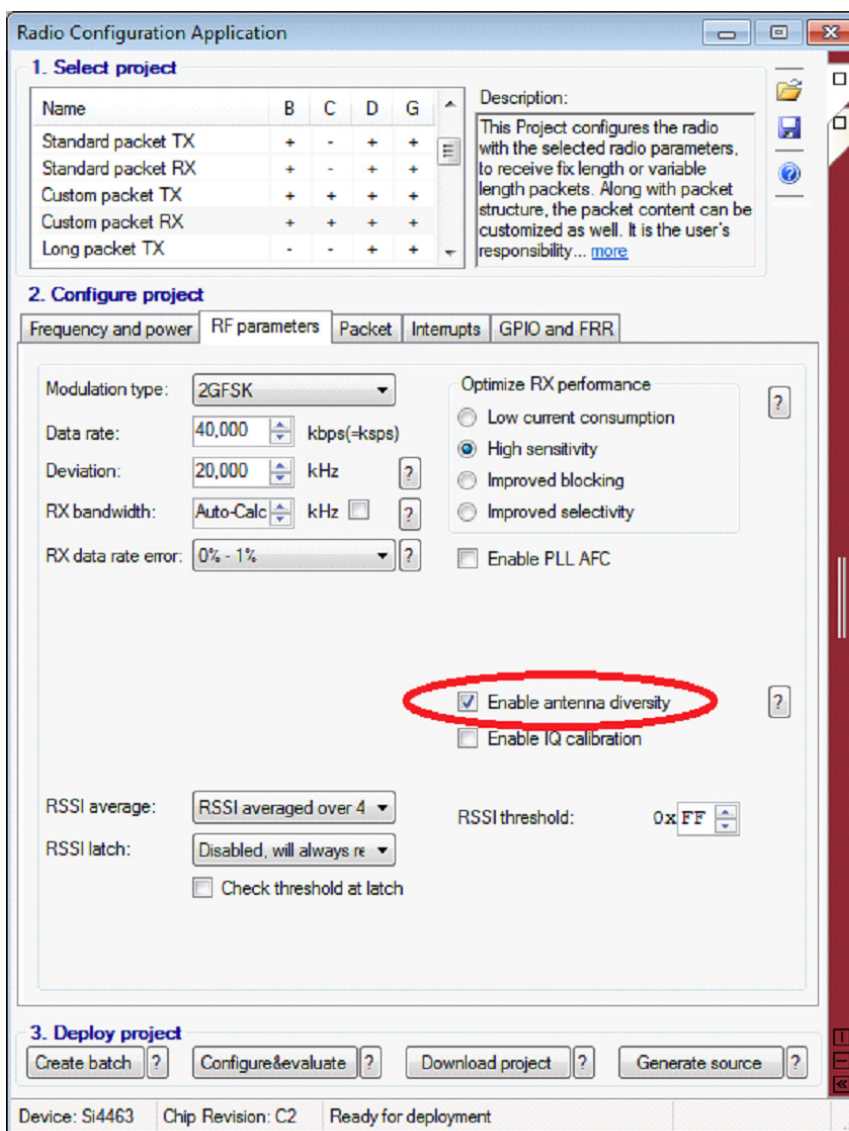

Figure 21. Antenna Diversity Enable

The user will need to create an RF test signal with the appropriate packet data structure. Possible methods of generation include the following:

- Manually programming an ArbGen or BER Analyzer with the required data packet structure, and using that to modulate a lab signal generator
- Using another Si446x RF Pico Board in Custom packet TX as the test signal source

5.2. AntDiv Switch Control Signals to Demonstrate Antenna Selection

As shown in Figure 20, GPIO0 and GPIO2 are used for antenna switching. This allows the user to configure the GPIO1 and GPIO3 pins to output other interesting signals related to antenna diversity functionality and the reception of the packet, such as RXDATA, PREAMBLE_VALID (PRE_DET), or the SYNC_OK signal. Figure 22 illustrates the reception of the RX_DATA and PRE_DET (PREAMBLE_VALID) signals, overlaid with the antenna diversity switch control signals (AntDivSw #1 & #2).

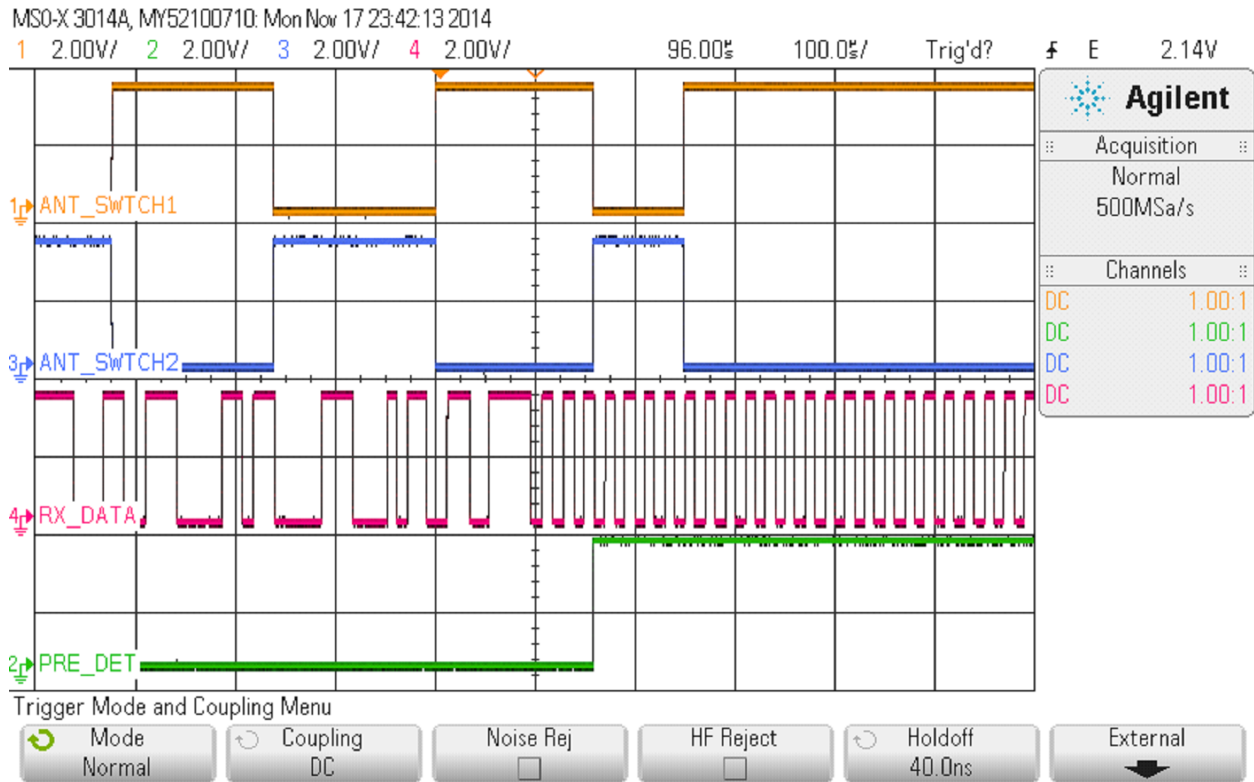

Figure 22. RX_DATA, PRE_DET, and Antenna Diversity Control Signals in Diversity Mode

The traces in Figure 22 clearly demonstrate the periodic toggling between selection of antennas in the time period prior to the arrival of the transmit packet, as indicated by detection of a valid preamble (i.e., demodulation of the consecutive number of 1010 bits specified by the RX_THRESH[6:0] field in API property PREAMBLE_CONFIG_STD_1). At this point in time, the chip issues a PREAMBLE_VALID (PRE_DET) signal, as illustrated in Figure 22. The PREAMBLE_VALID signal remains high until the packet has been received. After arrival of the transmit packet, the antenna diversity algorithm dwells on one antenna for a sufficient period of time to allow detection of the preamble and evaluation of RSSI, followed by switching to the alternate antenna for quick evaluation of the RSSI value on the other antenna. The antenna selection is then switched back to re-select the first antenna, as the RF attenuators had been configured to provide a stronger signal to Antenna #1 than to Antenna #2 (in this example).

The user should clearly understand that unless the system is designed for time synchronization between the transmitter and receiver, the receiver generally has no prior knowledge of when the transmit packet will arrive. Thus the state of the AntDivSw #1 & #2 control signals (and the antenna selection) is arbitrary at the instant the packet arrives, due to the periodic toggling between antennas. Figure 22 illustrates a case where the stronger antenna was arbitrarily selected at the arrival time of the packet; while the alternate antenna was subsequently evaluated for signal strength, the final decision was to switch back to the original (stronger) antenna for the remainder of the packet. However, there is an equal probability that the weaker antenna may be arbitrarily selected at the arrival time of the packet. In such a case, the algorithm proceeds to evaluate the signal strength of the alternate antenna,

and remains on the alternate antenna for the remainder of the packet due to its greater signal strength. This is illustrated in Figure 23.

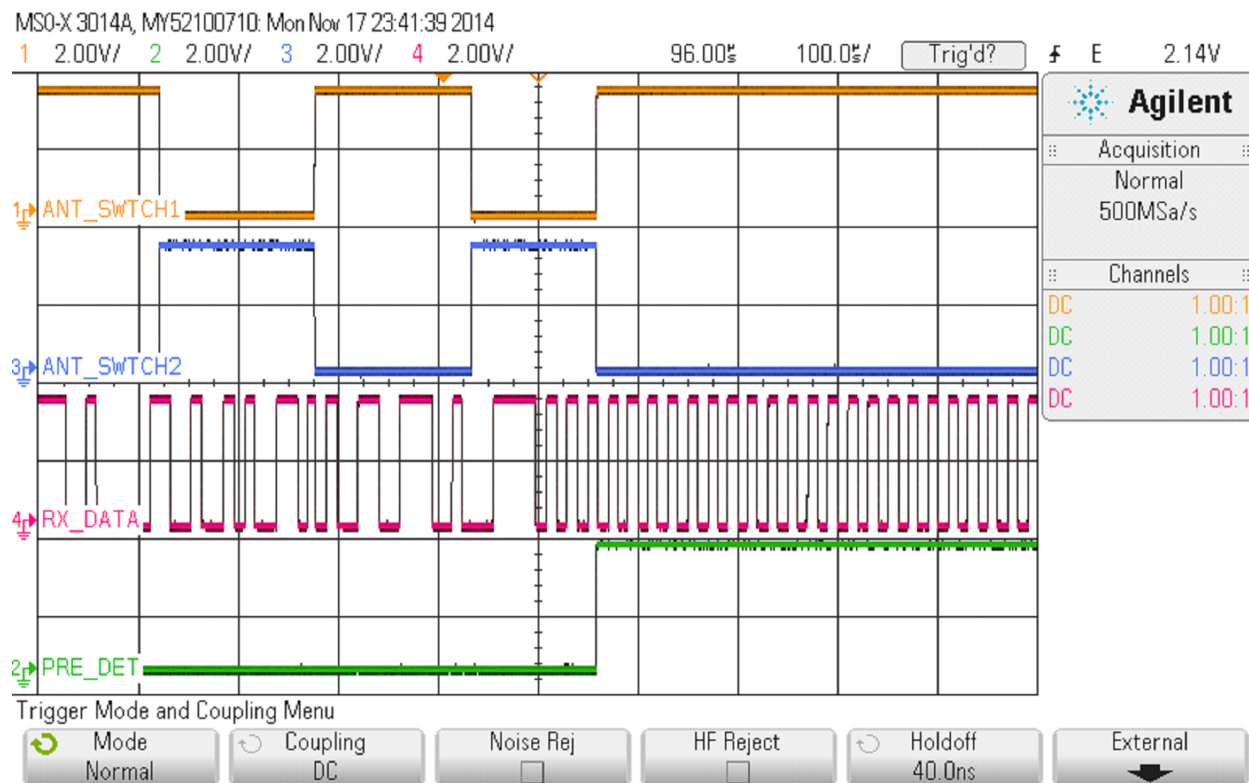

Figure 23. RX_DATA, PRE_DET, and Antenna Diversity Control Signals in Diversity Mode (Alternate Timing)

The important point to be gained from these two plots is that, regardless of the initial state of antenna selection at the arrival of the packet, the stronger antenna was always reliably selected by the algorithm. In this example, the RF attenuator(s) were adjusted to provide a 6 dB stronger signal on Antenna #1 than on Antenna #2, and thus Antenna #1 was always selected.

Figure 24 demonstrates the case where the RF attenuators are adjusted such that the signal on Antenna #1 is 6 dB weaker than on Antenna #2. The result is that the final state of the AntDivSw #1 and #2 control signals now switch to indicate that Antenna #2 is selected to receive the remainder of the packet.

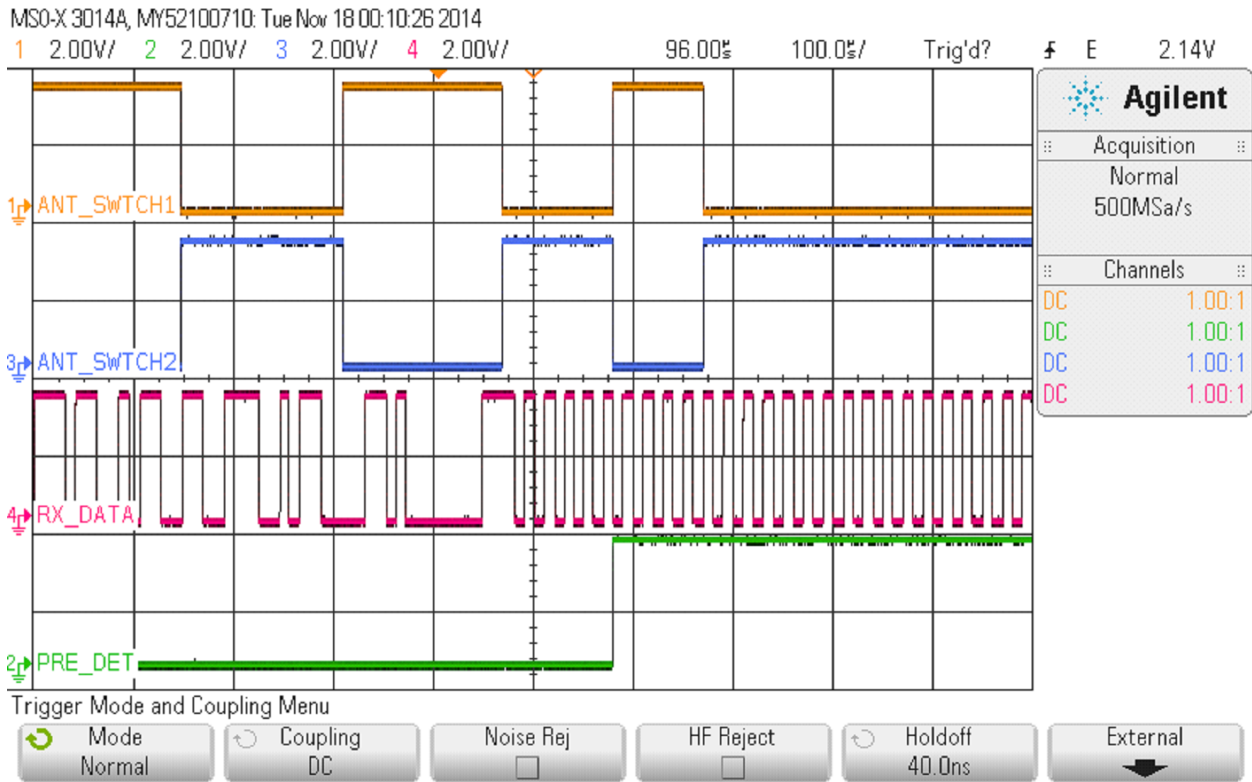

Figure 24. RX_DATA, PRE_DET, and Antenna Diversity Control Signals in Diversity Mode (Alternate RF Levels)

It is self-evident that if equal signal levels are applied to both antenna inputs, the antenna diversity algorithm has no basis for selecting one antenna over the other. Under such conditions, the algorithm should select one or the other antenna as the "optimal" antenna with roughly equal probability. The window of uncertainty in the RSSI measurement and antenna signal strength evaluation process is only about 2 dB wide; at relative signal levels exceeding this value, the antenna selection is essentially error-free.

5.3. Faster Evaluation by Skipping Alternate Antenna Evaluation

As discussed in section "2.3. Implementation of Antenna Diversity Algorithm", under certain conditions the RSSI evaluation on the alternate antenna may be skipped, thus reducing the overall amount of time required to complete the antenna selection process. This may be advantageous in systems that need to scan a large number of channels in the shortest possible amount of time. This functionality is enabled by setting the SKIP2PH bit in API property MODEM_ANT_DIV_MODE. The following script modification may be used to configure the chip to demonstrate this mode of operation. (The initial value of this register was 0x01).

```
'SET_PROPERTY' 'MODEM_ANT_DIV_MODE' 11
```

In this mode, the RSSI value for the antenna that first obtained a PREAMBLE_VALID (PRE_DET) indication (RSSI1 in Figure 25) is compared with the previous RSSI value, obtained on the alternate antenna. As no PREAMBLE_VALID (PRE_DET) signal was previously obtained on this alternate antenna, it is self-evident that the RSSI_prev value must reflect measurement of noise, prior to the arrival of the packet. Thus the difference in RSSI value between the current RSSI measurement and the previous RSSI measurement is indicative of how far the desired signal is above the noise floor of the receiver. If this difference in RSSI level exceeds a certain threshold (i.e., the desired signal is above the noise floor by a sufficient amount), the signal on that antenna is deemed strong enough to receive without bit errors, and thus there is no need to also evaluate the signal strength on the alternate antenna. That is to say, if zero bit errors may be obtained on one antenna, there is no point in switching to (or even

evaluating) an alternate antenna that may potentially provide a stronger signal.

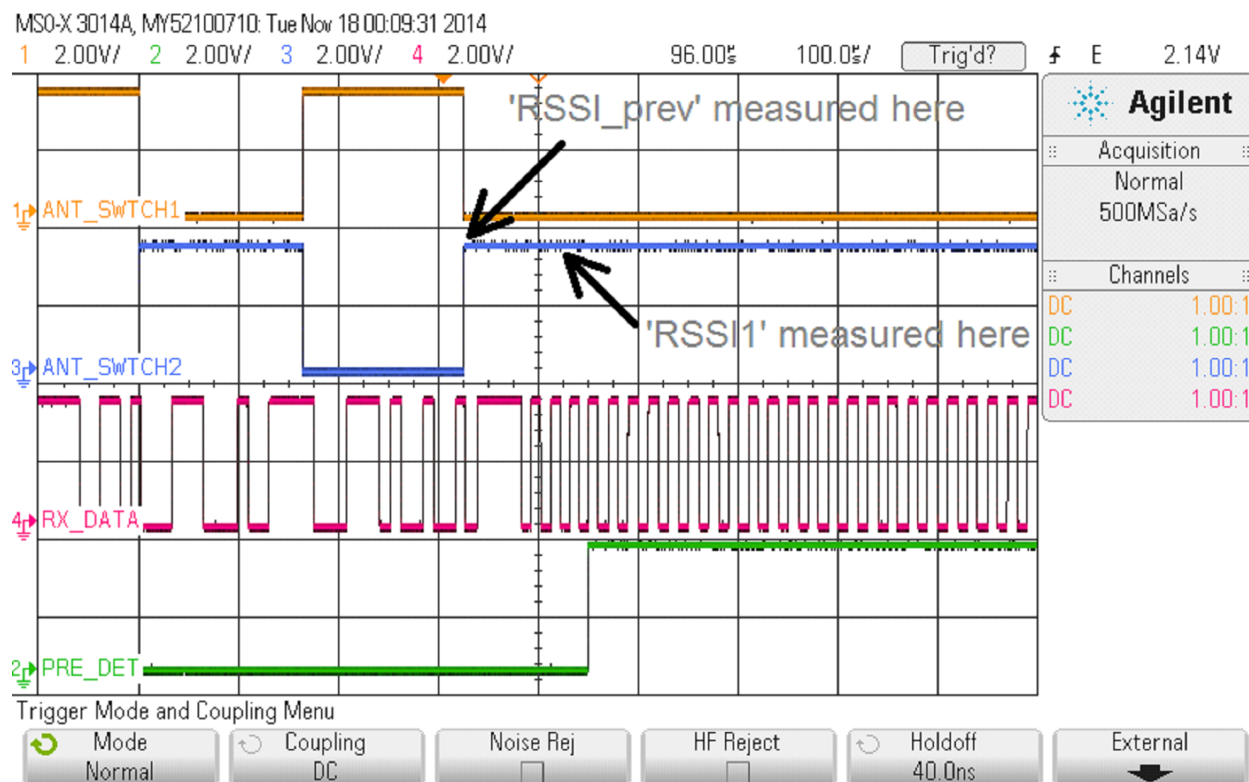

Figure 25. Skipping Alternate Antenna Evaluation

Figure 25 illustrates this mode of operation. For this test scenario, the RF attenuators were set so that the signal level on the alternate antenna was greatly reduced below the noise floor of the receiver. The PREAMBLE_VALID (PRE_DET) signal is developed on the stronger antenna; however, no attempt is now made to switch to the alternate antenna, as the RSSI value of the current antenna (RSSI1) is judged to be sufficiently above the previous RSSI value (RSSI_prev).

The signal threshold that must be exceeded in order to skip evaluation of the alternate antenna is controlled by the SKIP2PHTH bit in API property MODEM_ANT_DIV_MODE, and is 16 dB for the default value of SKIP2PHTH = 0. Setting SKIP2PHTH = 1 results in a threshold value of 11 dB.

6. Recommended Preamble Lengths

The recommended minimal preamble lengths for Antenna Diversity operation can be found in Table 3:

Table 3. Recommended Minimal Preamble Lengths

Mode	Chip Revision	PLL AFC	Antenna Diversity	Preamble Type	Recommend Min Preamble Length
OOK	B1	disabled	enabled	standard	80 bits
OOK	C2	disabled	enabled	standard	80 bits
(G)FSK	B1	disabled	enabled	standard	80 bits
(G)FSK	B1	enabled	enabled	standard	88 bits
(G)FSK	C2	disabled	enabled	standard	64 bits
(G)FSK	C2	enabled	enabled	standard	64 bits
4(G)FSK	B1	disabled	enabled	standard	80 symbols
4(G)FSK	B1	enabled	enabled	standard	88 symbols
4(G)FSK	C2	disabled	enabled	standard	64 symbols
4(G)FSK	C2	enabled	enabled	standard	64 symbols

7. Conclusion

The Silicon Labs Antenna Diversity RF Pico Board (4463CPCE20A915) operated in a dynamic multi-path fading environment with the antenna diversity algorithm enabled provides nearly 5-6 dB improvement in link performance, when compared with operation with antenna diversity disabled (i.e., fixed antenna selection). It is possible that this amount of link range improvement can be increased further, as the small physical dimensions of the RF Pico Boards (i.e., small spatial separation between antennas) may currently be limiting the performance. Boards with greater spatial separation between antennas, or with larger ground plane, might add to this improvement even more.

Antenna diversity provides the greatest benefit when signal conditions are near end-of-range sensitivity levels. In this scenario, antenna diversity will provide a robust link while operation with antenna diversity disabled may provide no-link performance. Under stronger signal conditions, selection of either antenna provides good link performance; in this scenario, antenna diversity performance is as good as non-antenna diversity performance.

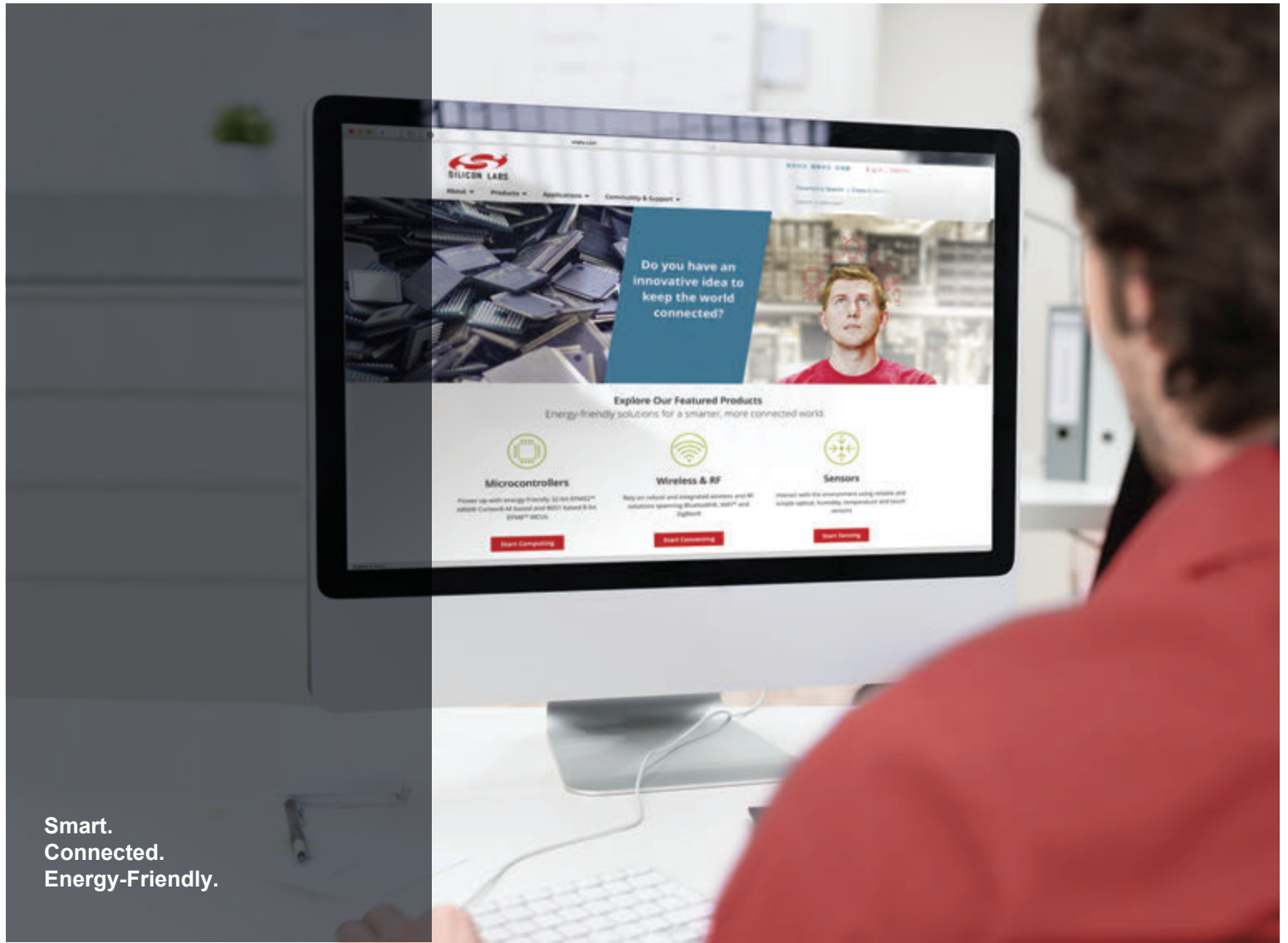

Smart.
Connected.
Energy-Friendly.



Products
www.silabs.com/products

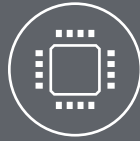

Quality
www.silabs.com/quality



Support and Community
community.silabs.com

Disclaimer
Silicon Labs intends to provide customers with the latest, accurate, and in-depth documentation of all peripherals and modules available for system and software implementers using or intending to use the Silicon Labs products. Characterization data, available modules and peripherals, memory sizes and memory addresses refer to each specific device, and "Typical" parameters provided can and do vary in different applications. Application examples described herein are for illustrative purposes only. Silicon Labs reserves the right to make changes without further notice and limitation to product information, specifications, and descriptions herein, and does not give warranties as to the accuracy or completeness of the included information. Silicon Labs shall have no liability for the consequences of use of the information supplied herein. This document does not imply or express copyright licenses granted hereunder to design or fabricate any integrated circuits. The products are not designed or authorized to be used within any Life Support System without the specific written consent of Silicon Labs. A "Life Support System" is any product or system intended to support or sustain life and/or health, which, if it fails, can be reasonably expected to result in significant personal injury or death. Silicon Labs products are not designed or authorized for military applications. Silicon Labs products shall under no circumstances be used in weapons of mass destruction including (but not limited to) nuclear, biological or chemical weapons, or missiles capable of delivering such weapons.

Trademark Information

Silicon Laboratories Inc.®, Silicon Laboratories®, Silicon Labs®, SiLabs® and the Silicon Labs logo®, Bluegiga®, Bluegiga Logo®, Clockbuilder®, CMEMS®, DSPLL®, EFM®, EFM32®, EFR, Ember®, Energy Micro, Energy Micro logo and combinations thereof, "the world's most energy friendly microcontrollers", Ember®, EZLink®, EZRadio®, EZRadioPRO®, Gecko®, ISOModem®, Precision32®, ProSLIC®, Simplicity Studio®, SiPHY®, Telegesis, the Telegesis Logo®, USBXpress® and others are trademarks or registered trademarks of Silicon Labs. ARM, CORTEX, Cortex-M3 and THUMB are trademarks or registered trademarks of ARM Holdings. Keil is a registered trademark of ARM Limited. All other products or brand names mentioned herein are trademarks of their respective holders.



SILICON LABS

Silicon Laboratories Inc.
400 West Cesar Chavez
Austin, TX 78701
USA

<http://www.silabs.com>