

# OPAx314 3MHz、低功耗、低噪声、RRIO、1.8V CMOS 运算放大器

## 1 特性

- 低  $I_Q$ : 150 $\mu$ A/通道
- 宽电源电压: 1.8V 至 5.5V
- 低噪声: 1kHz 下为 14nV/ $\sqrt{\text{Hz}}$
- 增益带宽: 3MHz
- 低输入偏置电流: 0.2pA
- 低偏移电压: 0.5mV
- 单位增益稳定
- 内部射频/电磁干扰 (RF/EMI) 滤波器
- 扩展温度范围:  
-40°C 至 125°C

## 2 应用范围

- 电池供电仪器:
  - 消费类应用、工业应用、医疗应用
  - 笔记本电脑、便携式媒体播放器
- 光电二极管放大器
- 有源滤波器
- 远程感测
- 无线计量
- 手持测试设备

电磁干扰抑制比 (EMIRR) 与频率间的关系

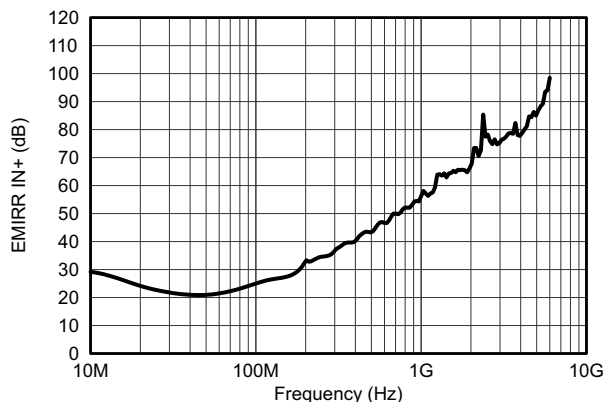

## 3 说明

OPA314 系列单通道、双通道和四通道运算放大器是新一代低功耗、通用互补金属氧化物半导体 (CMOS) 放大器的典型代表。该器件系列将轨到轨输入和输出摆幅、低静态电流 (5  $V_S$  时的典型值为 150 $\mu$ A) 与 3MHz 高带宽和极低噪声 (1kHz 时为 14nV/ $\sqrt{\text{Hz}}$ ) 相结合, 广泛应用于 要求在成本和性能间达到良好平衡的 电池供电应用。低输入偏置电流支持 源阻抗高达兆欧级的 应用。

OPA314 器件采用稳健耐用的设计, 方便电路设计人员使用。该器件具有单位增益稳定的集成 RF/EMI 抑制滤波器, 在过驱条件下不会出现反相并且具有高静电放电 (ESD) 保护 (4kV 人体模型 (HBM))。

此类器件经过优化, 适合在 1.8V ( $\pm 0.9V$ ) 至 5.5V ( $\pm 2.75V$ ) 的低电压状态下工作并可在 -40°C 至 125°C 的完全扩展温度范围内额定运行。

OPA314 (单通道) 采用 SC70-5 和小外形尺寸晶体管 (SOT)23-5 封装。OPA2314 (双通道) 采用小外形尺寸 (SO)-8, 微型小外形尺寸 (MSOP)-8 和四方扁平无引线 (DFN)-8 封装。四通道 OPA4314 采用薄型小外形尺寸 (TSSOP)-14 封装。

器件信息<sup>(1)</sup>

器件型号	封装	封装尺寸 (标称值)
OPA314	SOT-23 (5)	2.90mm x 1.60mm
	SC70 (5)	2.00mm x 1.25mm
OPA2314	VSSOP (8)	3.00mm x 3.00mm
	SOIC (8)	4.90mm x 3.91mm
	VSON (8)	3.00mm x 3.00mm
OPA4314	薄型小外形尺寸封装 (TSSOP) (14)	5.00mm x 4.40mm

(1) 要了解所有可用封装, 请见数据表末尾的可订购产品附录。



## 目录

1 特性 .....	1	7.3 Feature Description .....	16
2 应用范围 .....	1	7.4 Device Functional Modes .....	19
3 说明 .....	1	<b>8 Application and Implementation</b> .....	<b>20</b>
4 修订历史记录 .....	2	8.1 Application Information .....	20
<b>5 Pin Configuration and Functions</b> .....	<b>4</b>	8.2 Typical Application .....	22
<b>6 Specifications</b> .....	<b>6</b>	<b>9 Power Supply Recommendations</b> .....	<b>24</b>
6.1 Absolute Maximum Ratings .....	6	<b>10 Layout</b> .....	<b>25</b>
6.2 ESD Ratings .....	6	10.1 Layout Guidelines .....	25
6.3 Recommended Operating Conditions .....	6	10.2 Layout Example .....	25
6.4 Thermal Information: OPA314 .....	6	<b>11 器件和文档支持</b> .....	<b>26</b>
6.5 Thermal Information: OPA2314 .....	7	11.1 器件支持 .....	26
6.6 Thermal Information: OPA4314 .....	7	11.2 相关链接 .....	26
6.7 Electrical Characteristics .....	7	11.3 社区资源 .....	26
6.8 Typical Characteristics .....	9	11.4 商标 .....	26
<b>7 Detailed Description</b> .....	<b>16</b>	11.5 静电放电警告 .....	26
7.1 Overview .....	16	11.6 Glossary .....	26
7.2 Functional Block Diagram .....	16	<b>12 机械、封装和可订购信息</b> .....	<b>27</b>

## 4 修订历史记录

注：之前版本的页码可能与当前版本有所不同。

<b>Changes from Revision F (April 2013) to Revision G</b>	<b>Page</b>
• 已添加 ESD 额定值表，特性描述部分，器件功能模式，应用和实施部分，电源相关建议部分，布局部分，器件和文档支持部分以及机械、封装和可订购信息部分 .....	1
• 已将修订历史记录移至第二页 .....	1
<hr/>	
<b>Changes from Revision E (September 2012) to Revision F</b>	<b>Page</b>
• 已更改 文档标题（删除了“超值系列”） .....	1
<hr/>	
<b>Changes from Revision D (March 2012) to Revision E</b>	<b>Page</b>
• 已将“超值系列”添加至标题 .....	1
<hr/>	
<b>Changes from Revision C (February 2012) to Revision D</b>	<b>Page</b>
• 已更改 将产品状态从混合状态改为生产数据 .....	1
• 已删除 封装信息表中的底纹和脚注 2 .....	1
<hr/>	
<b>Changes from Revision B (December 2011) to Revision C</b>	<b>Page</b>
• 已更改 第一项 特性 要点 .....	1
• 已删除 封装信息表 OPA314 SOT23-5 行（DBV 封装）的底纹 .....	1
• Added OPA2314, OPA4314 to first two Power Supply, <i>Quiescent current per amplifier</i> parameter rows in Electrical Characteristics table .....	8
• Added OPA314 Power Supply, <i>Quiescent current per amplifier</i> parameter row to Electrical Characteristics table .....	8

**Changes from Revision A (August 2011) to Revision B****Page**

- 
- 已删除 封装信息表 OPA2314 MSOP-8 行的底纹 ..... 1
-

## 5 Pin Configuration and Functions

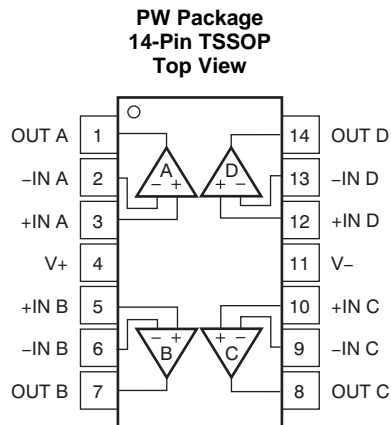
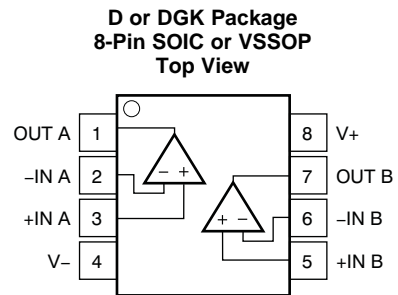
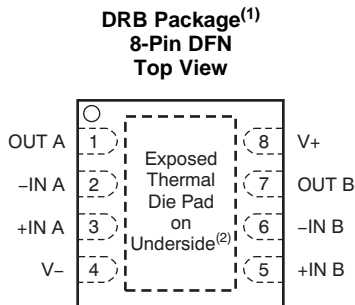
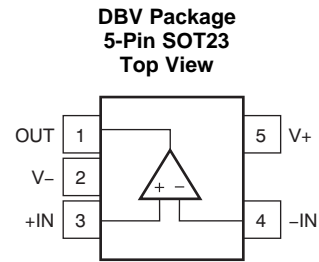
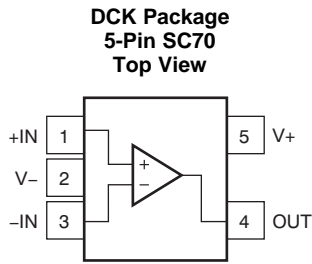

(1) Pitch: 0.65 mm.

(2) Connect thermal pad to V-. Pad size: 1.8 mm × 1.5 mm.

### Pin Functions: OPA314

NAME	PIN		I/O	DESCRIPTION
	DBV	DCK		
+IN	3	1	I	Noninverting input
-IN	4	3	I	Inverting input
OUT	1	4	O	Output
V+	5	5	—	Positive (highest) supply
V-	2	2	—	Negative (lowest) supply

**Pin Functions: OPA2314**

NAME	PIN			I/O	DESCRIPTION
	DRB	DGK	D		
+IN A	3	3	3	I	Noninverting input
+IN B	5	5	5	I	Noninverting input
–IN A	2	2	2	I	Inverting input
–IN B	6	6	6	I	Inverting input
OUT A	1	1	1	O	Output
OUT B	7	7	7	O	Output
V+	8	8	8	—	Positive (highest) supply
V–	4	4	4	—	Negative (lowest) supply

**Pin Functions: OPA4314**

NAME	PIN		I/O	DESCRIPTION
	NO.			
+IN A	3		I	Noninverting input
+IN B	5		I	Noninverting input
+IN C	10		I	Noninverting input
+IN D	12		I	Noninverting input
–IN A	2		I	Inverting input
–IN B	6		I	Inverting input
–IN C	9		I	Inverting input
–IN D	13		I	Inverting input
OUT A	1		O	Output
OUT B	7		O	Output
OUT C	8		O	Output
OUT D	14		O	Output
V+	4		—	Positive (highest) supply
V–	11		—	Negative (lowest) supply

## 6 Specifications

### 6.1 Absolute Maximum Ratings

Over operating free-air temperature range, unless otherwise noted.<sup>(1)</sup>

		MIN	MAX	UNIT
Supply voltage		7		V
Signal input terminals	Voltage <sup>(2)</sup>	(V–) – 0.5	(V+) + 0.5	V
	Current <sup>(2)</sup>	–10	10	mA
Output short-circuit <sup>(3)</sup>		Continuous		mA
Operating temperature, T <sub>A</sub>		–40	150	°C
Junction temperature, T <sub>J</sub>				°C
Storage temperature, T <sub>stg</sub>		–65	150	°C

- Stresses above these ratings may cause permanent damage. Exposure to absolute maximum conditions for extended periods may degrade device reliability. These are stress ratings only, and functional operation of the device at these or any other conditions beyond those specified is not supported.
- Input terminals are diode-clamped to the power-supply rails. Input signals that can swing more than 0.5 V beyond the supply rails should be current limited to 10 mA or less.
- Short-circuit to ground, one amplifier per package.

### 6.2 ESD Ratings

		VALUE	UNIT
V <sub>(ESD)</sub> Electrostatic discharge	Human-body model (HBM), per ANSI/ESDA/JEDEC JS-001 <sup>(1)</sup>	±4000	V
	Charged-device model (CDM), per JEDEC specification JESD22-C101 <sup>(2)</sup>	±1000	
	Machine model (MM)	±200	

- JEDEC document JEP155 states that 500-V HBM allows safe manufacturing with a standard ESD control process.
- JEDEC document JEP157 states that 250-V CDM allows safe manufacturing with a standard ESD control process.

### 6.3 Recommended Operating Conditions

over operating free-air temperature range (unless otherwise noted)

		MIN	NOM	MAX	UNIT
V <sub>S</sub>	Supply voltage	1.8 (±0.9)		5.5 (±2.75)	V
T <sub>A</sub>	Ambient operating temperature	–40		125	°C

### 6.4 Thermal Information: OPA314

THERMAL METRIC <sup>(1)</sup>	OPA314			UNIT	
	DBV (SOT23)	DCK (SC70)	DRL (SOT553)		
	5 PINS	5 PINS	5 PINS		
R <sub>θJA</sub>	Junction-to-ambient thermal resistance	228.5	281.4	208.1	°C/W
R <sub>θJC(top)</sub>	Junction-to-case(top) thermal resistance	99.1	91.6	0.1	°C/W
R <sub>θJB</sub>	Junction-to-board thermal resistance	54.6	59.6	42.4	°C/W
Ψ <sub>JT</sub>	Junction-to-top characterization parameter	7.7	1.5	0.5	°C/W
Ψ <sub>JB</sub>	Junction-to-board characterization parameter	53.8	58.8	42.2	°C/W

- For more information about traditional and new thermal metrics, see the *Semiconductor and IC Package Thermal Metrics* application report, [SPRA953](#).

## 6.5 Thermal Information: OPA2314

THERMAL METRIC <sup>(1)</sup>		OPA2314			UNIT
		D (SO)	DGK (MSOP)	DRB (DFN)	
		8 PINS	8 PINS	8 PINS	
R <sub>θJA</sub>	Junction-to-ambient thermal resistance	138.4	191.2	53.8	°C/W
R <sub>θJC(top)</sub>	Junction-to-case(top) thermal resistance	89.5	61.9	69.2	°C/W
R <sub>θJB</sub>	Junction-to-board thermal resistance	78.6	111.9	20.1	°C/W
Ψ <sub>JT</sub>	Junction-to-top characterization parameter	29.9	5.1	3.8	°C/W
Ψ <sub>JB</sub>	Junction-to-board characterization parameter	78.1	110.2	11.6	°C/W

(1) For more information about traditional and new thermal metrics, see the *Semiconductor and IC Package Thermal Metrics* application report, [SPRA953](#).

## 6.6 Thermal Information: OPA4314

THERMAL METRIC <sup>(1)</sup>		OPA4314		UNIT
		D (SOIC)	PW (TSSOP)	
		14 PINS	14 PINS	
R <sub>θJA</sub>	Junction-to-ambient thermal resistance	93.2	121	°C/W
R <sub>θJC(top)</sub>	Junction-to-case(top) thermal resistance	51.8	49.4	°C/W
R <sub>θJB</sub>	Junction-to-board thermal resistance	49.4	62.8	°C/W
Ψ <sub>JT</sub>	Junction-to-top characterization parameter	13.5	5.9	°C/W
Ψ <sub>JB</sub>	Junction-to-board characterization parameter	42.2	62.2	°C/W

(1) For more information about traditional and new thermal metrics, see the *Semiconductor and IC Package Thermal Metrics* application report, [SPRA953](#).

## 6.7 Electrical Characteristics

V<sub>S</sub> = 1.8 V to 5.5 V; At T<sub>A</sub> = 25 °C, R<sub>L</sub> = 10 kΩ connected to V<sub>S</sub>/2, V<sub>CM</sub> = V<sub>S</sub>/2, and V<sub>OUT</sub> = V<sub>S</sub>/2, unless otherwise noted.<sup>(1)</sup>

PARAMETER	TEST CONDITIONS	T <sub>A</sub> = 25 °C			T <sub>A</sub> = -40°C to 125°C			UNIT
		MIN	TYP	MAX	MIN	TYP	MAX	
<b>OFFSET VOLTAGE</b>								
V <sub>OS</sub>	Input offset voltage	V <sub>CM</sub> = (V <sub>S+</sub> ) - 1.3 V		0.5	2.5			mV
dV <sub>OS</sub> /dT	vs Temperature					1		μV/°C
PSRR	vs power supply	V <sub>CM</sub> = (V <sub>S+</sub> ) - 1.3 V		78	92			dB
	Over temperature					74		dB
	Channel separation, DC	At DC		10				μV/V
<b>INPUT VOLTAGE RANGE</b>								
V <sub>CM</sub>	Common-mode voltage range			(V <sub>-</sub> ) - 0.2	(V <sub>+</sub> ) + 0.2			V
CMRR	Common-mode rejection ratio	V <sub>S</sub> = 1.8 V to 5.5 V, (V <sub>S-</sub> ) - 0.2 V < V <sub>CM</sub> < (V <sub>S+</sub> ) - 1.3 V		75	96			dB
		V <sub>S</sub> = 5.5 V, V <sub>CM</sub> = -0.2 V to 5.7 V <sup>(2)</sup>		66	80			dB
	Over temperature	V <sub>S</sub> = 1.8 V, (V <sub>S-</sub> ) - 0.2 V < V <sub>CM</sub> < (V <sub>S+</sub> ) - 1.3 V				70	86	dB
		V <sub>S</sub> = 5.5 V, (V <sub>S-</sub> ) - 0.2 V < V <sub>CM</sub> < (V <sub>S+</sub> ) - 1.3 V				73	90	dB
		V <sub>S</sub> = 5.5 V, V <sub>CM</sub> = -0.2 V to 5.7 V <sup>(2)</sup>				60		dB
<b>INPUT BIAS CURRENT</b>								
I <sub>B</sub>	Input bias current			±0.2	±10			pA
	Over temperature						±600	pA
I <sub>OS</sub>	Input offset current			±0.2	±10			pA
	Over temperature						±600	pA
<b>NOISE</b>								
	Input voltage noise (peak-to-peak)	f = 0.1 Hz to 10 Hz		5				μV <sub>PP</sub>

(1) Parameters with minimum or maximum specification limits are 100% production tested at +25°C, unless otherwise noted. Over temperature limits are based on characterization and statistical analysis.

(2) Specified by design and characterization; not production tested.

**Electrical Characteristics (continued)**
 $V_S = 1.8\text{ V to }5.5\text{ V}$ ; At  $T_A = 25\text{ }^\circ\text{C}$ ,  $R_L = 10\text{ k}\Omega$  connected to  $V_S/2$ ,  $V_{CM} = V_S/2$ , and  $V_{OUT} = V_S/2$ , unless otherwise noted.<sup>(1)</sup>

PARAMETER		TEST CONDITIONS	$T_A = 25\text{ }^\circ\text{C}$			$T_A = -40\text{ }^\circ\text{C to }125\text{ }^\circ\text{C}$			UNIT
			MIN	TYP	MAX	MIN	TYP	MAX	
$e_n$	Input voltage noise density	$f = 10\text{ kHz}$		13					nV/ $\sqrt{\text{Hz}}$
		$f = 1\text{ kHz}$		14					nV/ $\sqrt{\text{Hz}}$
$i_n$	Input current noise density	$f = 1\text{ kHz}$		5					fA/ $\sqrt{\text{Hz}}$
<b>INPUT CAPACITANCE</b>									
$C_{IN}$	Differential	$V_S = 5\text{ V}$		1					pF
	Common-mode	$V_S = 5\text{ V}$		5					pF
<b>OPEN-LOOP GAIN</b>									
$A_{OL}$	Open-loop voltage gain	$V_S = 1.8\text{ V}, 0.2\text{ V} < V_O < (V+) - 0.2\text{ V}, R_L = 10\text{ k}\Omega$	90	115					dB
		$V_S = 5.5\text{ V}, 0.2\text{ V} < V_O < (V+) - 0.2\text{ V}, R_L = 10\text{ k}\Omega$	100	128					dB
		$V_S = 1.8\text{ V}, 0.5\text{ V} < V_O < (V+) - 0.5\text{ V}, R_L = 2\text{ k}\Omega^{(2)}$	90	100					dB
		$V_S = 5.5\text{ V}, 0.5\text{ V} < V_O < (V+) - 0.5\text{ V}, R_L = 2\text{ k}\Omega^{(2)}$	94	110					dB
Over temperature		$V_S = 5.5\text{ V}, 0.2\text{ V} < V_O < (V+) - 0.2\text{ V}, R_L = 10\text{ k}\Omega$				90	110		dB
		$V_S = 5.5\text{ V}, 0.5\text{ V} < V_O < (V+) - 0.2\text{ V}, R_L = 2\text{ k}\Omega$					100		dB
Phase margin		$V_S = 5\text{ V}, G = 1, R_L = 10\text{ k}\Omega$		65					°
<b>FREQUENCY RESPONSE</b>									
GBW	Gain-bandwidth product	$V_S = 1.8\text{ V}, R_L = 10\text{ k}\Omega, C_L = 10\text{ pF}$		2.7					MHz
		$V_S = 5\text{ V}, R_L = 10\text{ k}\Omega, C_L = 10\text{ pF}$		3					MHz
SR	Slew rate <sup>(3)</sup>	$V_S = 5\text{ V}, G = 1$		1.5					V/ $\mu\text{s}$
$t_s$	Settling time	To 0.1%, $V_S = 5\text{ V}, 2\text{-V step}, G = 1$		2.3					$\mu\text{s}$
		To 0.01%, $V_S = 5\text{ V}, 2\text{-V step}, G = 1$		3.1					$\mu\text{s}$
Overload recovery time		$V_S = 5\text{ V}, V_{IN} \times \text{Gain} > V_S$		5.2					$\mu\text{s}$
THD+N	Total harmonic distortion + noise <sup>(4)</sup>	$V_S = 5\text{ V}, V_O = 1\text{ V}_{RMS}, G = +1, f = 1\text{ kHz}, R_L = 10\text{ k}\Omega$		0.001%					
<b>OUTPUT</b>									
$V_O$	Voltage output swing from supply rails	$V_S = 1.8\text{ V}, R_L = 10\text{ k}\Omega$		5	15				mV
		$V_S = 5.5\text{ V}, R_L = 10\text{ k}\Omega$		5	20				mV
		$V_S = 1.8\text{ V}, R_L = 2\text{ k}\Omega$		15	30				mV
		$V_S = 5.5\text{ V}, R_L = 2\text{ k}\Omega$		22	40				mV
Over temperature		$V_S = 5.5\text{ V}, R_L = 10\text{ k}\Omega$						30	mV
		$V_S = 5.5\text{ V}, R_L = 2\text{ k}\Omega$					60		mV
$I_{SC}$	Short-circuit current	$V_S = 5\text{ V}$		$\pm 20$					mA
$R_O$	Open-loop output impedance	$V_S = 5.5\text{ V}, f = 100\text{ Hz}$		570					$\Omega$
<b>POWER SUPPLY</b>									
$V_S$	Specified voltage range		1.8		5.5				V
$I_Q$	Quiescent current per amplifier	OPA314, OPA2314, OPA4314, $V_S = 1.8\text{ V}, I_O = 0\text{ mA}$		130	180				$\mu\text{A}$
		OPA2314, OPA4314, $V_S = 5\text{ V}, I_O = 0\text{ mA}$		150	190				$\mu\text{A}$
		OPA314, $V_S = 5\text{ V}, I_O = 0\text{ mA}$		150	210				$\mu\text{A}$
Over temperature		$V_S = 5\text{ V}, I_O = 0\text{ mA}$					220		$\mu\text{A}$
Power-on time		$V_S = 0\text{ V to }5\text{ V}, \text{ to }90\% I_Q \text{ level}$		44					$\mu\text{s}$
<b>TEMPERATURE</b>									
Specified range			-40		125				$^\circ\text{C}$
Operating range			-40		150				$^\circ\text{C}$

(3) Signifies the slower value of the positive or negative slew rate.

(4) Third-order filter; bandwidth = 80 kHz at -3 dB.



## Electrical Characteristics (continued)

$V_S = 1.8\text{ V to }5.5\text{ V}$ ; At  $T_A = 25\text{ }^\circ\text{C}$ ,  $R_L = 10\text{ k}\Omega$  connected to  $V_S/2$ ,  $V_{CM} = V_S/2$ , and  $V_{OUT} = V_S/2$ , unless otherwise noted.<sup>(1)</sup>

PARAMETER	TEST CONDITIONS	$T_A = 25\text{ }^\circ\text{C}$			$T_A = -40\text{ }^\circ\text{C to }125\text{ }^\circ\text{C}$			UNIT
		MIN	TYP	MAX	MIN	TYP	MAX	
Storage range		-65		150				$^\circ\text{C}$

## 6.8 Typical Characteristics

**Table 1. Characteristic Performance Measurements**

TITLE	FIGURE
Open-Loop Gain and Phase vs Frequency	<a href="#">Figure 1</a>
Open-Loop Gain vs Temperature	<a href="#">Figure 2</a>
Quiescent Current vs Supply Voltage	<a href="#">Figure 3</a>
Quiescent Current vs Temperature	<a href="#">Figure 4</a>
Offset Voltage Production Distribution	<a href="#">Figure 5</a>
Offset Voltage Drift Distribution	<a href="#">Figure 6</a>
Offset Voltage vs Common-Mode Voltage (Maximum Supply)	<a href="#">Figure 7</a>
Offset Voltage vs Temperature	<a href="#">Figure 8</a>
CMRR and PSRR vs Frequency (RTI)	<a href="#">Figure 9</a>
CMRR and PSRR vs Temperature	<a href="#">Figure 10</a>
0.1-Hz to 10-Hz Input Voltage Noise (5.5 V)	<a href="#">Figure 11</a>
Input Voltage Noise Spectral Density vs Frequency (1.8 V, 5.5 V)	<a href="#">Figure 12</a>
Input Voltage Noise vs Common-Mode Voltage (5.5 V)	<a href="#">Figure 13</a>
Input Bias and Offset Current vs Temperature	<a href="#">Figure 14</a>
Open-Loop Output Impedance vs Frequency	<a href="#">Figure 15</a>
Maximum Output Voltage vs Frequency and Supply Voltage	<a href="#">Figure 16</a>
Output Voltage Swing vs Output Current (over Temperature)	<a href="#">Figure 17</a>
Closed-Loop Gain vs Frequency, $G = 1, -1, 10$ (1.8 V)	<a href="#">Figure 18</a>
Closed-Loop Gain vs Frequency, $G = 1, -1, 10$ (5.5 V)	<a href="#">Figure 19</a>
Small-Signal Overshoot vs Load Capacitance	<a href="#">Figure 20</a>
Small-Signal Step Response, Noninverting (1.8 V)	<a href="#">Figure 21</a>
Small-Signal Step Response, Noninverting ( 5.5 V)	<a href="#">Figure 22</a>
Large-Signal Step Response, Noninverting (1.8 V)	<a href="#">Figure 23</a>
Large-Signal Step Response, Noninverting ( 5.5 V)	<a href="#">Figure 24</a>
Positive Overload Recovery	<a href="#">Figure 25</a>
Negative Overload Recovery	<a href="#">Figure 26</a>
No Phase Reversal	<a href="#">Figure 27</a>
Channel Separation vs Frequency (Dual)	<a href="#">Figure 28</a>
THD+N vs Amplitude ( $G = 1, 2\text{ k}\Omega, 10\text{ k}\Omega$ )	<a href="#">Figure 29</a>
THD+N vs Amplitude ( $G = -1, 2\text{ k}\Omega, 10\text{ k}\Omega$ )	<a href="#">Figure 30</a>
THD+N vs Frequency ( $0.5\text{ V}_{RMS}, G = +1, 2\text{ k}\Omega, 10\text{ k}\Omega$ )	<a href="#">Figure 31</a>
EMIRR	<a href="#">Figure 32</a>

OPA314, OPA2314, OPA4314

ZHCS183G –MAY 2011–REVISED JUNE 2015

www.ti.com.cn

At  $T_A = 25^\circ\text{C}$ ,  $R_L = 10\text{ k}\Omega$  connected to  $V_{S/2}$ ,  $V_{CM} = V_{S/2}$ , and  $V_{OUT} = V_{S/2}$ , unless otherwise noted.

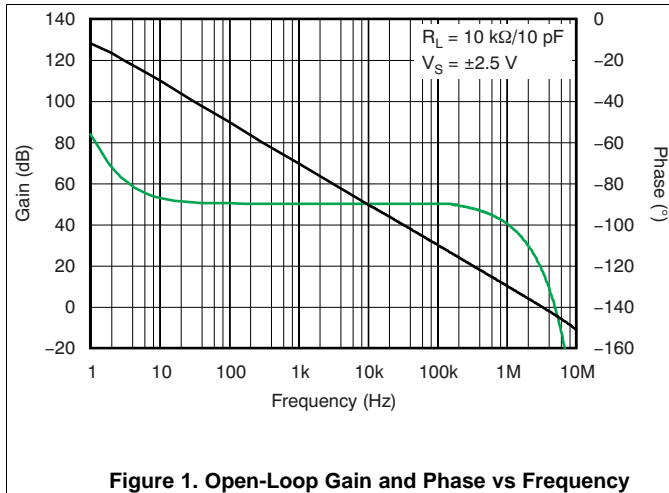

Figure 1. Open-Loop Gain and Phase vs Frequency

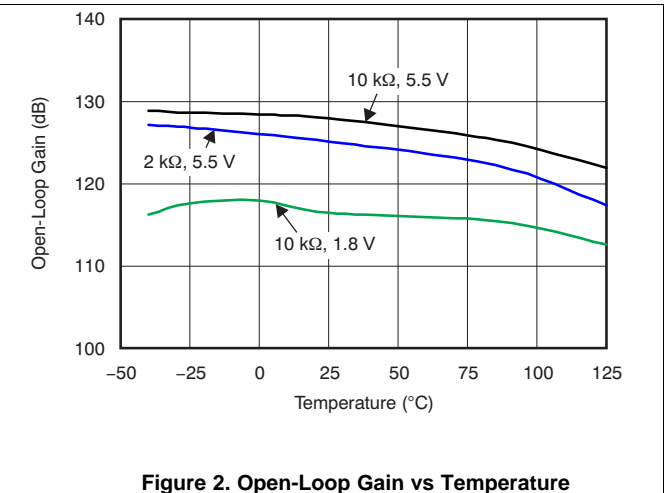

Figure 2. Open-Loop Gain vs Temperature

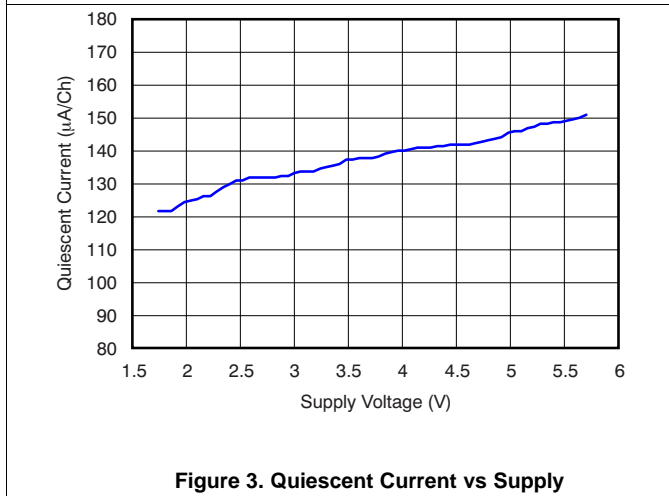

Figure 3. Quiescent Current vs Supply

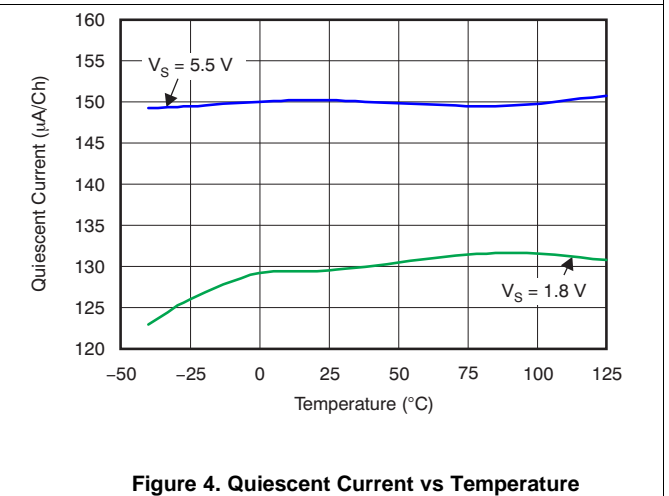

Figure 4. Quiescent Current vs Temperature

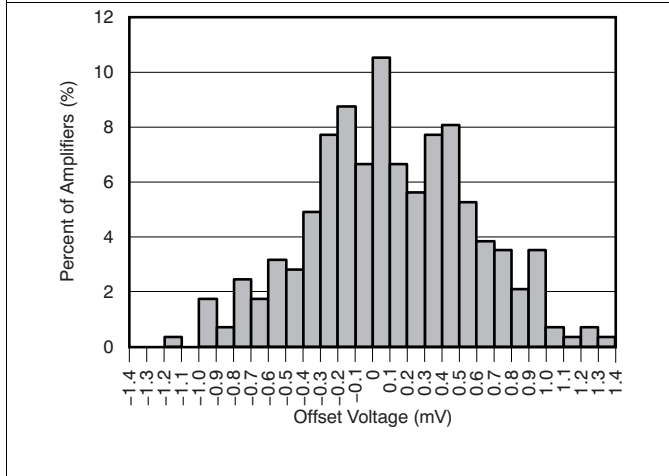

Figure 5. Offset Voltage Production Distribution

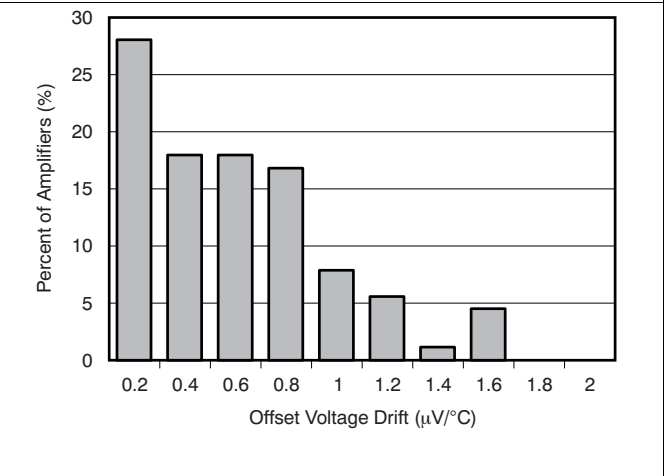

Figure 6. Offset Voltage Drift Distribution

At  $T_A = 25^\circ\text{C}$ ,  $R_L = 10\text{ k}\Omega$  connected to  $V_S/2$ ,  $V_{CM} = V_S/2$ , and  $V_{OUT} = V_S/2$ , unless otherwise noted.

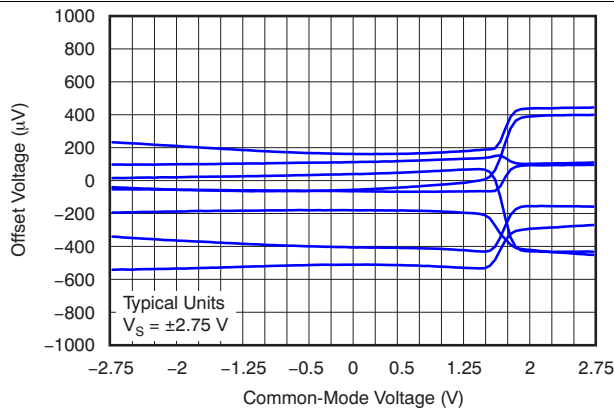

Figure 7. Offset Voltage vs Common-Mode Voltage

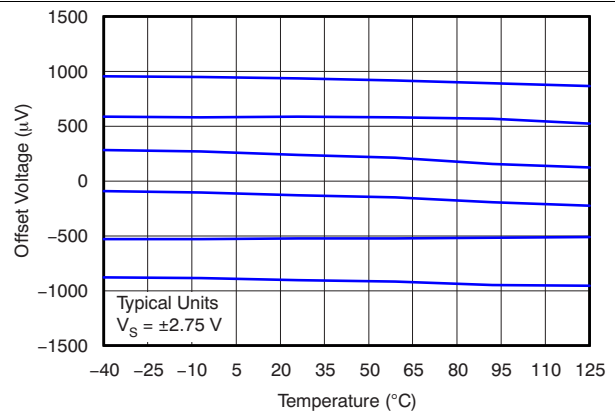

Figure 8. Offset Voltage vs Temperature

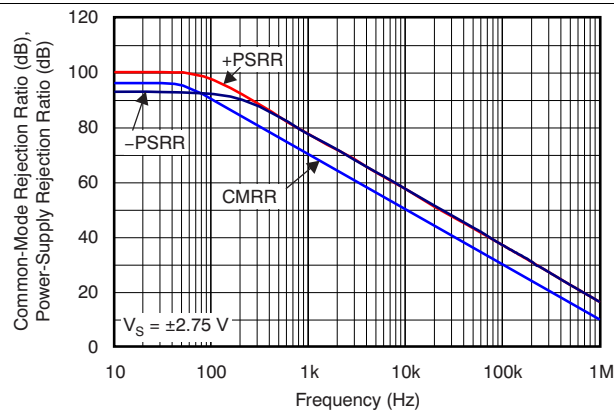

Figure 9. CMRR and PSRR vs Frequency (Referred-to-Input)

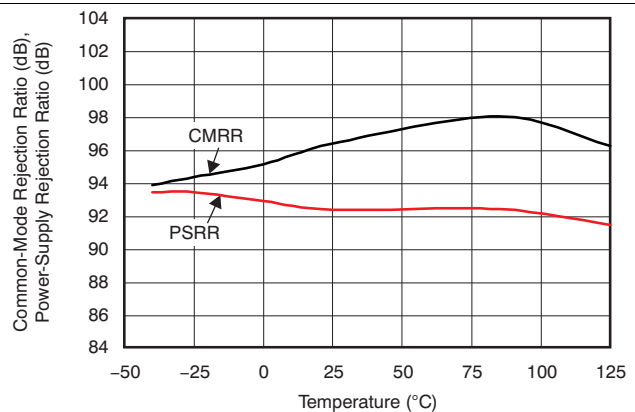

Figure 10. CMRR and PSRR vs Temperature

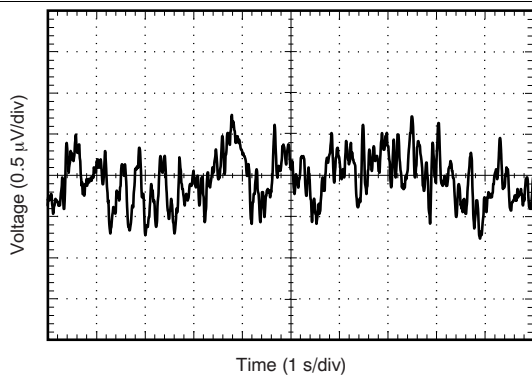

Figure 11. 0.1-Hz to 10-Hz Input Voltage Noise

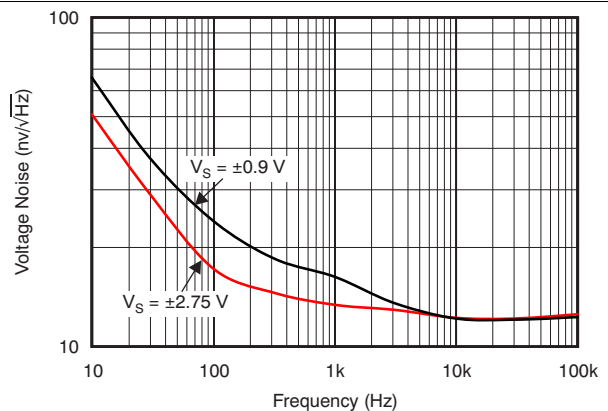

Figure 12. Input Voltage Noise Spectral Density vs Frequency

At  $T_A = 25^\circ\text{C}$ ,  $R_L = 10\text{ k}\Omega$  connected to  $V_S/2$ ,  $V_{CM} = V_S/2$ , and  $V_{OUT} = V_S/2$ , unless otherwise noted.

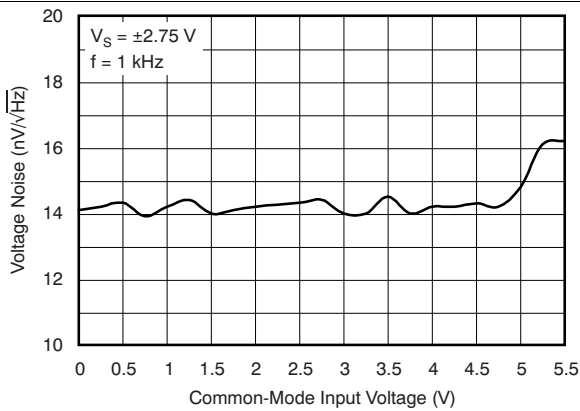

Figure 13. Voltage Noise vs Common-Mode Voltage

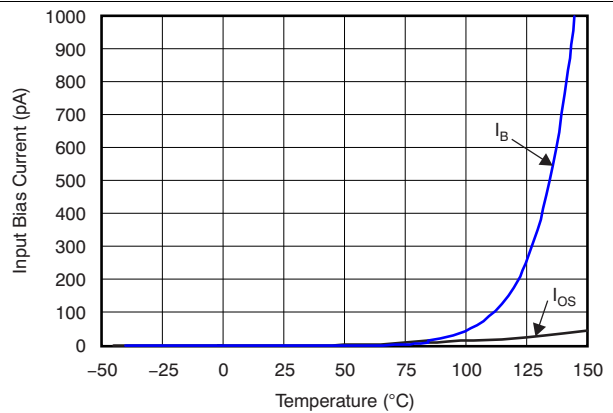

Figure 14. Input Bias and Offset Current vs Temperature

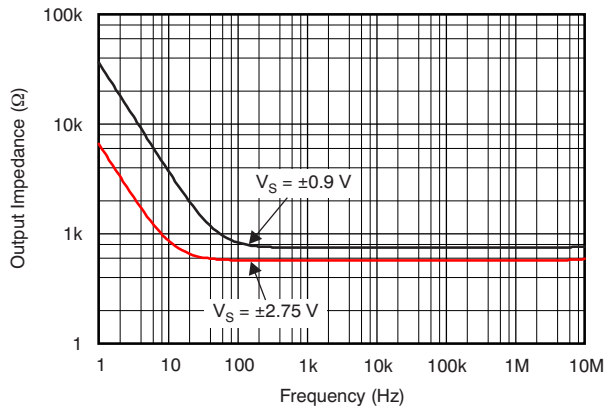

Figure 15. Open-Loop Output Impedance vs Frequency

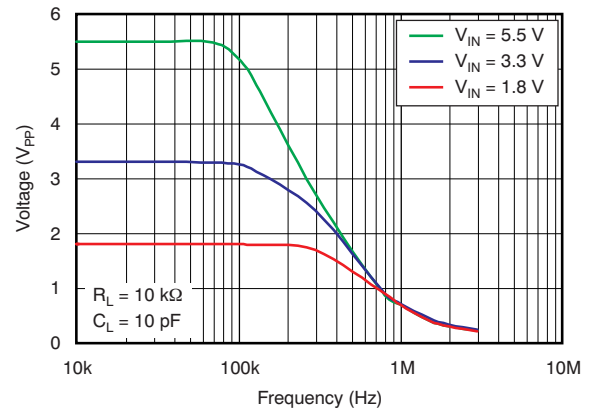

Figure 16. Maximum Output Voltage vs Frequency and Supply Voltage

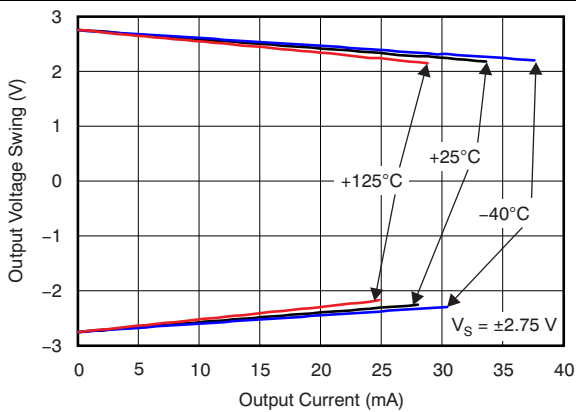

Figure 17. Output Voltage Swing vs Output Current (Over Temperature)

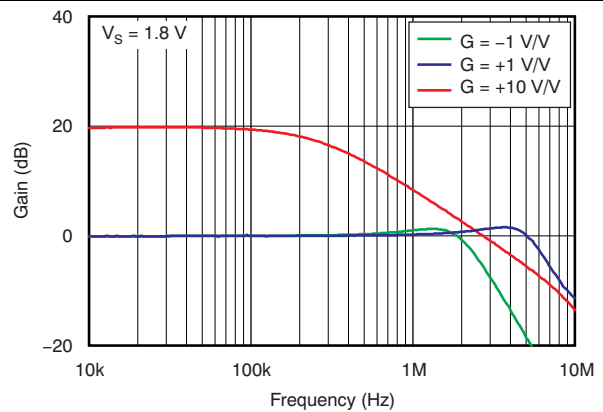

Figure 18. Closed-Loop Gain vs Frequency

At  $T_A = 25^\circ\text{C}$ ,  $R_L = 10\text{ k}\Omega$  connected to  $V_S/2$ ,  $V_{CM} = V_S/2$ , and  $V_{OUT} = V_S/2$ , unless otherwise noted.

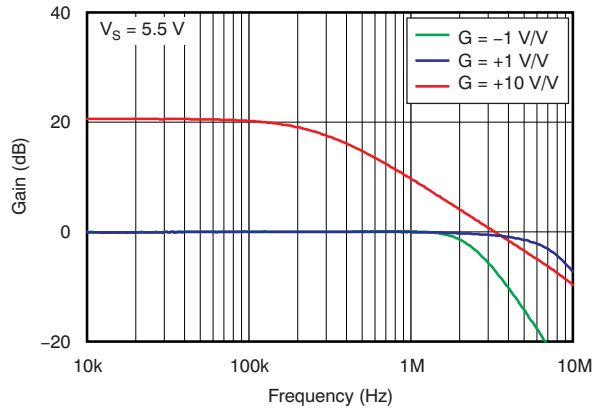

Figure 19. Closed-Loop Gain vs Frequency

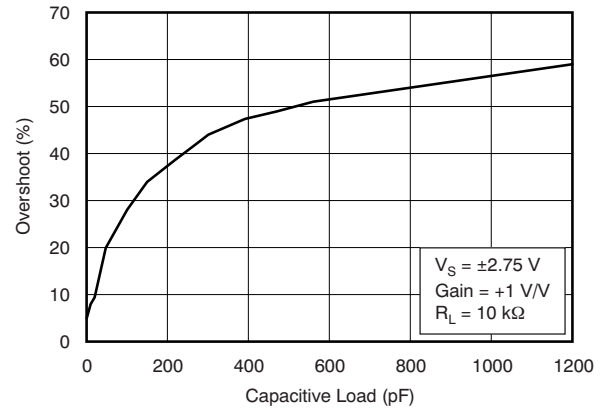

Figure 20. Small-Signal Overshoot vs Load Capacitance

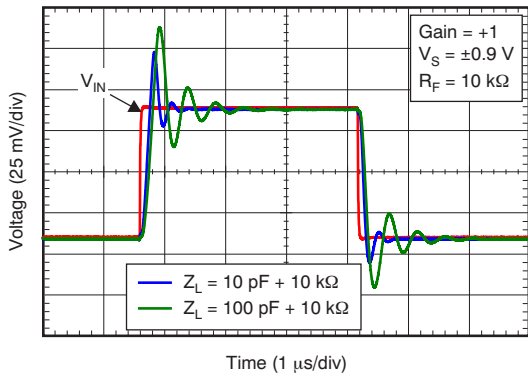

Figure 21. Small-Signal Pulse Response (Noninverting)

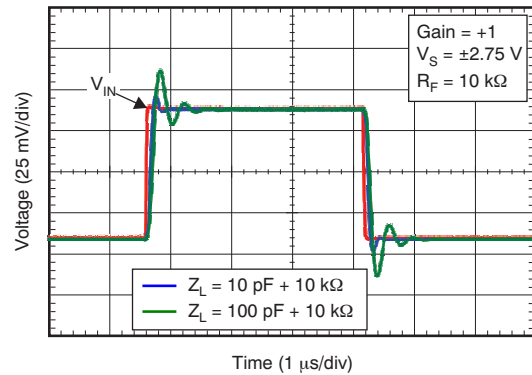

Figure 22. Small-Signal Pulse Response (Inverting)

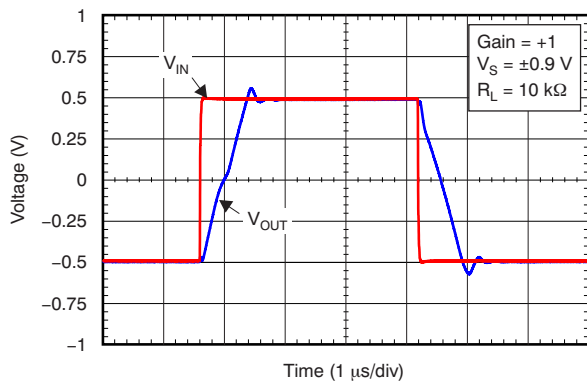

Figure 23. Large-Signal Pulse Response (Noninverting)

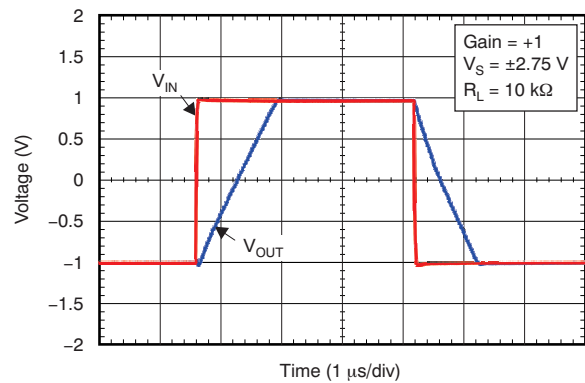
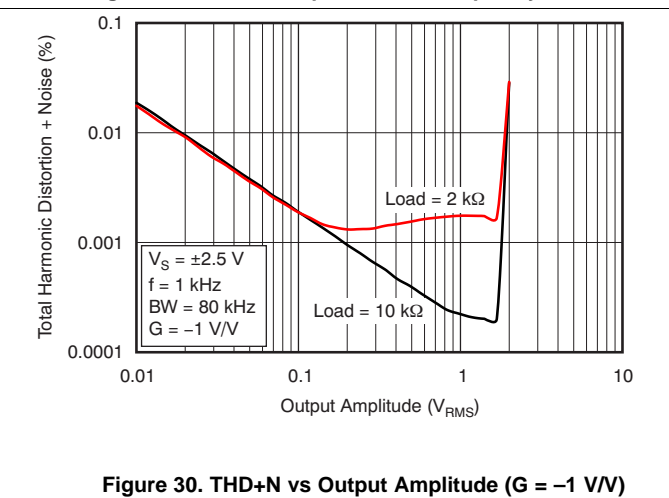
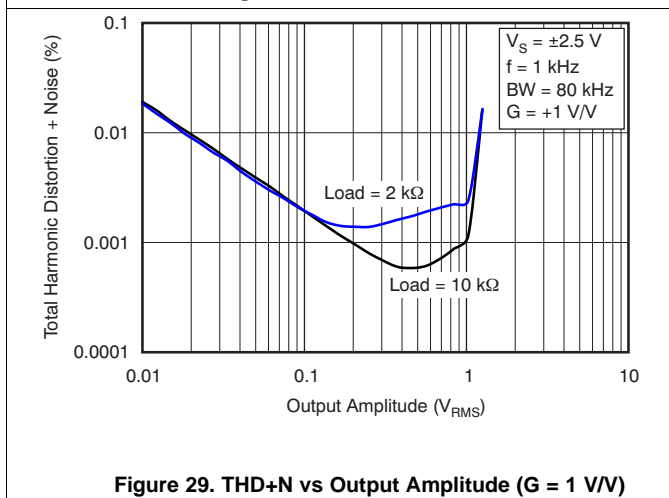
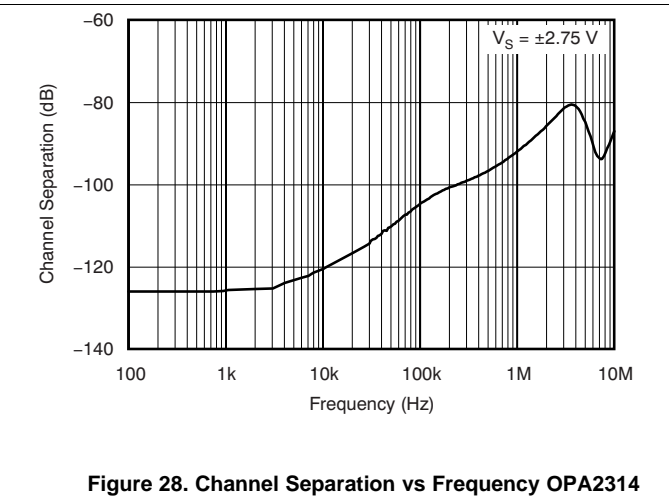
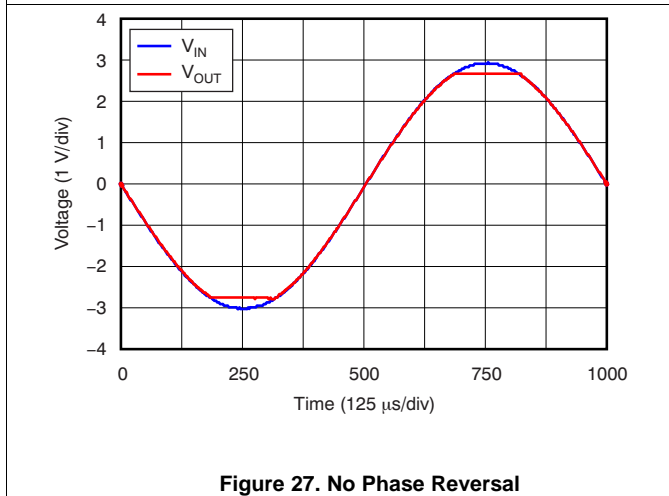
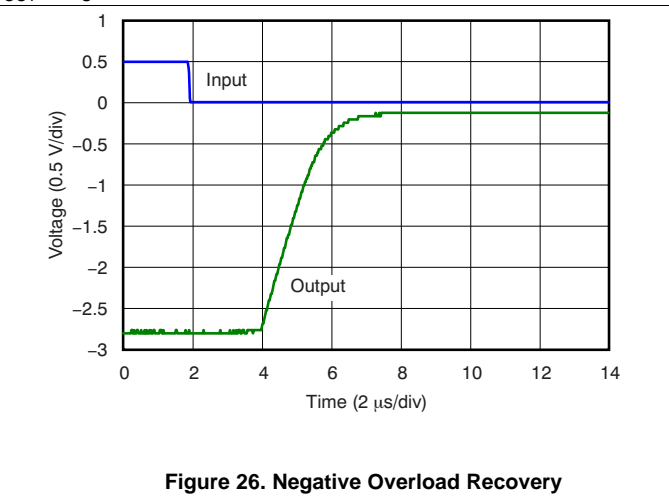
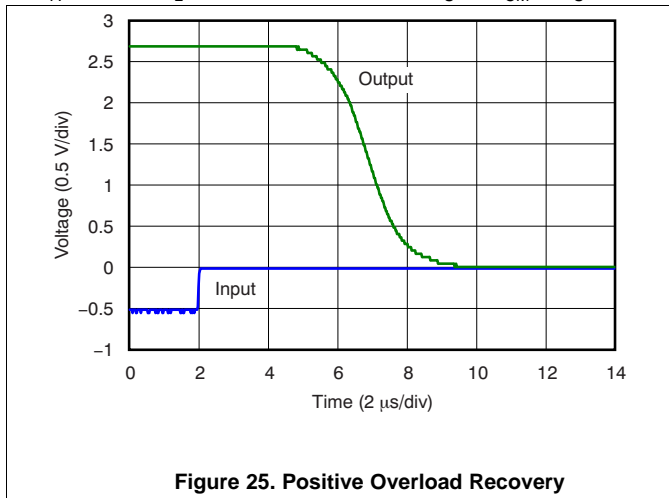
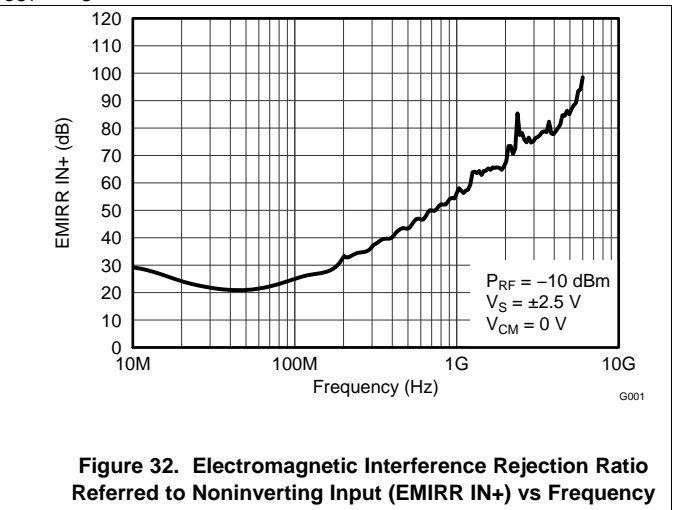
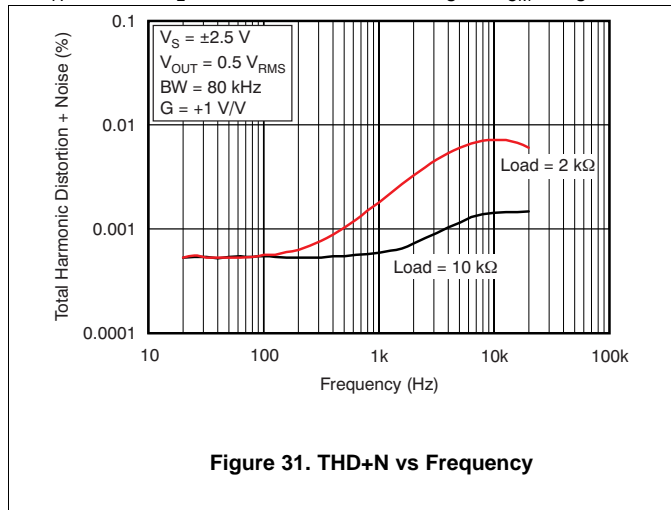

Figure 24. Large-Signal Pulse Response (Inverting)

At  $T_A = 25^\circ\text{C}$ ,  $R_L = 10\text{ k}\Omega$  connected to  $V_S/2$ ,  $V_{CM} = V_S/2$ , and  $V_{OUT} = V_S/2$ , unless otherwise noted.



At  $T_A = 25^\circ\text{C}$ ,  $R_L = 10\text{ k}\Omega$  connected to  $V_S/2$ ,  $V_{CM} = V_S/2$ , and  $V_{OUT} = V_S/2$ , unless otherwise noted.



## 7 Detailed Description

### 7.1 Overview

The OPA314 is a family of low-power, rail-to-rail input and output operational amplifiers specifically designed for portable applications. These devices operate from 1.8 V to 5.5 V, are unity-gain stable, and suitable for a wide range of general-purpose applications. The class AB output stage is capable of driving  $\leq 10\text{-k}\Omega$  loads connected to any point between  $V+$  and ground. The input common-mode voltage range includes both rails, and allows the OPA314 series to be used in virtually any single-supply application. Rail-to-rail input and output swing significantly increases dynamic range, especially in low-supply applications, and makes them ideal for driving sampling analog-to-digital converters (ADCs).

The OPA314 features 3-MHz bandwidth and  $1.5\text{-V}/\mu\text{s}$  slew rate with only  $150\text{-}\mu\text{A}$  supply current per channel, providing good AC performance at very low power consumption. DC applications are also well served with a very low input noise voltage of  $14\text{ nV}/\sqrt{\text{Hz}}$  at 1 kHz, low input bias current ( $0.2\text{ pA}$ ), and an input offset voltage of  $0.5\text{ mV}$  (typical).

### 7.2 Functional Block Diagram

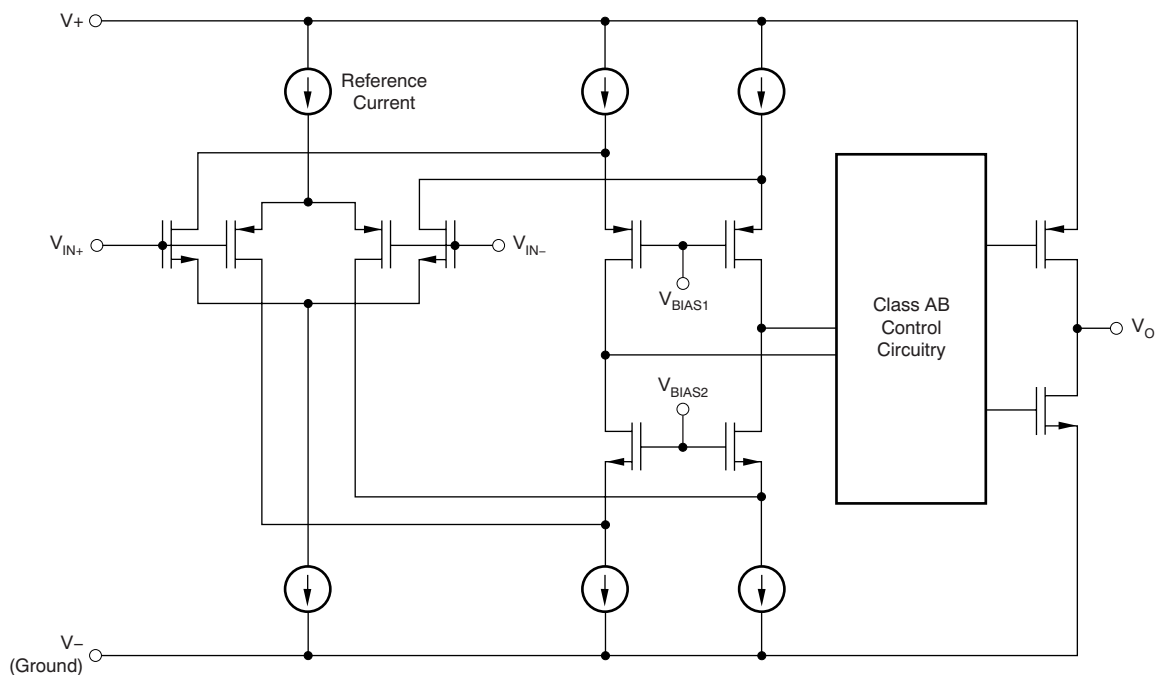

### 7.3 Feature Description

#### 7.3.1 Operating Voltage

The OPA314 series operational amplifiers are fully specified and ensured for operation from 1.8 V to 5.5 V. In addition, many specifications apply from  $-40^{\circ}\text{C}$  to  $125^{\circ}\text{C}$ . Parameters that vary significantly with operating voltages or temperature are shown in the *Typical Characteristics* graphs. Power-supply pins should be bypassed with  $0.01\text{-}\mu\text{F}$  ceramic capacitors.



## Feature Description (continued)

### 7.3.2 Rail-to-Rail Input

The input common-mode voltage range of the OPA314 series extends 200 mV beyond the supply rails. This performance is achieved with a complementary input stage: an N-channel input differential pair in parallel with a P-channel differential pair, as shown in Figure 33. The N-channel pair is active for input voltages close to the positive rail, typically  $(V+) - 1.3\text{ V}$  to 200 mV above the positive supply, while the P-channel pair is on for inputs from 200 mV below the negative supply to approximately  $(V+) - 1.3\text{ V}$ . There is a small transition region, typically  $(V+) - 1.4\text{ V}$  to  $(V+) - 1.2\text{ V}$ , in which both pairs are on. This 200-mV transition region can vary up to 300 mV with process variation. Thus, the transition region (both stages on) can range from  $(V+) - 1.7\text{ V}$  to  $(V+) - 1.5\text{ V}$  on the low end, up to  $(V+) - 1.1\text{ V}$  to  $(V+) - 0.9\text{ V}$  on the high end. Within this transition region, PSRR, CMRR, offset voltage, offset drift, and THD may be degraded compared to device operation outside this region.

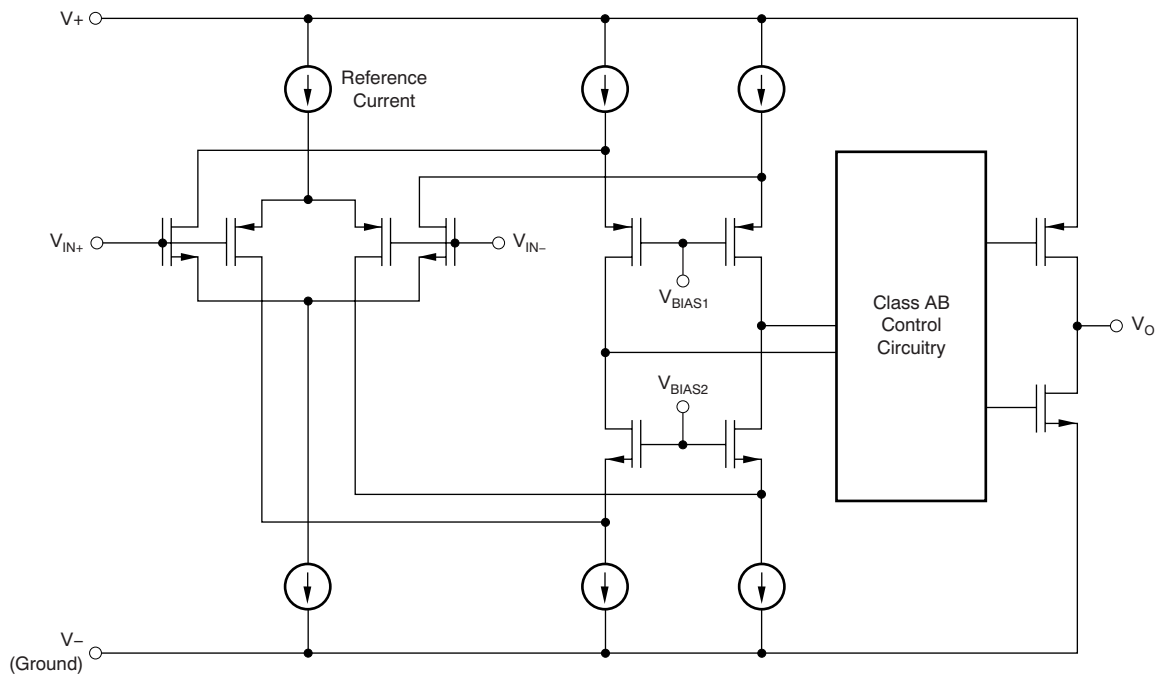

Figure 33. Simplified Schematic

### 7.3.3 Input and ESD Protection

The OPA314 family incorporates internal electrostatic discharge (ESD) protection circuits on all pins. In the case of input and output pins, this protection primarily consists of current-steering diodes connected between the input and power-supply pins. These ESD protection diodes also provide in-circuit, input overdrive protection, as long as the current is limited to 10 mA as stated in the [Absolute Maximum Ratings](#). Figure 34 shows how a series input resistor may be added to the driven input to limit the input current. The added resistor contributes thermal noise at the amplifier input and its value should be kept to a minimum in noise-sensitive applications.

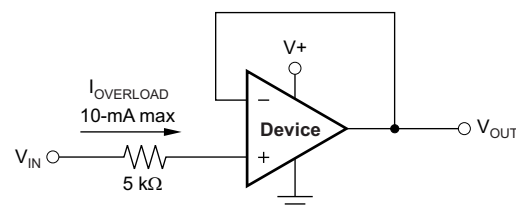

Figure 34. Input Current Protection

## Feature Description (continued)

### 7.3.4 Common-Mode Rejection Ratio (CMRR)

CMRR for the OPA314 is specified in several ways so the best match for a given application may be used; see the [Electrical Characteristics](#). First, the CMRR of the device in the common-mode range below the transition region [ $V_{CM} < (V+) - 1.3 \text{ V}$ ] is given. This specification is the best indicator of the capability of the device when the application requires use of one of the differential input pairs. Second, the CMRR over the entire common-mode range is specified at ( $V_{CM} = -0.2 \text{ V}$  to  $5.7 \text{ V}$ ). This last value includes the variations seen through the transition region (see [Figure 7](#)).

### 7.3.5 EMI Susceptibility and Input Filtering

Operational amplifiers vary with regard to the susceptibility of the device to electromagnetic interference (EMI). If conducted EMI enters the operational amplifier, the DC offset observed at the amplifier output may shift from its nominal value while EMI is present. This shift is a result of signal rectification associated with the internal semiconductor junctions. While all operational amplifier pin functions can be affected by EMI, the signal input pins are likely to be the most susceptible. The OPA314 operational amplifier family incorporate an internal input low-pass filter that reduces the amplifiers response to EMI. Both common-mode and differential mode filtering are provided by this filter. The filter is designed for a cutoff frequency of approximately 80 MHz ( $-3 \text{ dB}$ ), with a roll-off of 20 dB per decade.

Texas Instruments has developed the ability to accurately measure and quantify the immunity of an operational amplifier over a broad frequency spectrum extending from 10 MHz to 6 GHz. The EMI rejection ratio (EMIRR) metric allows operational amplifiers to be directly compared by the EMI immunity. [Figure 32](#) illustrates the results of this testing on the OPAX314. Detailed information can also be found in the application report, *EMI Rejection Ratio of Operational Amplifiers* ([SBOA128](#)), available for download from [www.ti.com](http://www.ti.com).

### 7.3.6 Rail-to-Rail Output

Designed as a micro-power, low-noise operational amplifier, the OPA314 delivers a robust output drive capability. A class AB output stage with common-source transistors is used to achieve full rail-to-rail output swing capability. For resistive loads up to 10 k $\Omega$ , the output swings typically to within 5 mV of either supply rail regardless of the power-supply voltage applied. Different load conditions change the ability of the amplifier to swing close to the rails; refer to [Figure 17](#).

### 7.3.7 Capacitive Load and Stability

The OPA314 is designed to be used in applications where driving a capacitive load is required. As with all operational amplifiers, there may be specific instances where the OPA314 can become unstable. The particular operational amplifiers circuit configuration, layout, gain, and output loading are some of the factors to consider when establishing whether or not an amplifier is stable in operation. An operational amplifier in the unity-gain ( $+1\text{-V/V}$ ) buffer configuration that drives a capacitive load exhibits a greater tendency to be unstable than an amplifier operated at a higher noise gain. The capacitive load, in conjunction with the operational amplifier output resistance, creates a pole within the feedback loop that degrades the phase margin. The degradation of the phase margin increases as the capacitive loading increases. When operating in the unity-gain configuration, the OPA314 remains stable with a pure capacitive load up to approximately 1 nF. The equivalent series resistance (ESR) of some very large capacitors ( $C_L$  greater than 1  $\mu\text{F}$ ) is sufficient to alter the phase characteristics in the feedback loop such that the amplifier remains stable. Increasing the amplifier closed-loop gain allows the amplifier to drive increasingly larger capacitance. This increased capability is evident when observing the overshoot response of the amplifier at higher voltage gains. See [Figure 20](#).

One technique for increasing the capacitive load drive capability of the amplifier operating in a unity-gain configuration is to insert a small resistor, typically 10  $\Omega$  to 20  $\Omega$ , in series with the output, as shown in [Figure 35](#). This resistor significantly reduces the overshoot and ringing associated with large capacitive loads. One possible problem with this technique, however, is that a voltage divider is created with the added series resistor and any resistor connected in parallel with the capacitive load. The voltage divider introduces a gain error at the output that reduces the output swing.

**Feature Description (continued)**

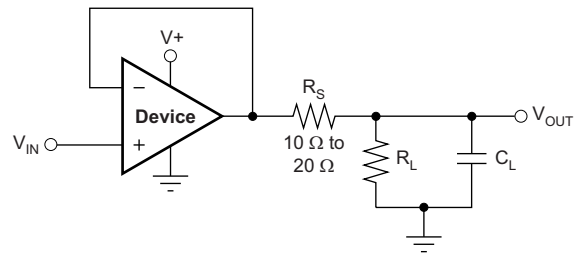

**Figure 35. Improving Capacitive Load Drive**

**7.4 Device Functional Modes**

The OPA2314 device is powered on when the supply is connected. The device can be operated as a single-supply operational amplifier or a dual-supply amplifier, depending on the application.

## 8 Application and Implementation

### NOTE

Information in the following applications sections is not part of the TI component specification, and TI does not warrant its accuracy or completeness. TI's customers are responsible for determining suitability of components for their purposes. Customers should validate and test their design implementation to confirm system functionality.

### 8.1 Application Information

The OPA2314 device is a low-power, rail-to-rail input and output operational amplifier specifically designed for portable applications. The device operates from 1.8 V to 5.5 V, is unity-gain stable, and suitable for a wide range of general-purpose applications. The class AB output stage is capable of driving  $\leq 10\text{-k}\Omega$  loads connected to any point between  $V+$  and ground. The input common-mode voltage range includes both rails, and allows the OPA2314 device to be used in virtually any single-supply application. Rail-to-rail input and output swing significantly increases dynamic range, especially in low-supply applications, and makes the device ideal for driving sampling analog-to-digital converters (ADCs).

The OPA2314 device features a 3-MHz bandwidth and 1.5-V/ $\mu\text{s}$  slew rate with only 150- $\mu\text{A}$  supply current per channel, providing good AC performance at very low power consumption. DC applications are also well served with a very-low input noise voltage of 14 nV/ $\sqrt{\text{Hz}}$  at 1 kHz, low-input bias current (0.2 pA), and an input offset voltage of 0.5 mV (typical).

#### 8.1.1 General Configurations

When receiving low-level signals, limiting the bandwidth of the incoming signals into the system is often required. The simplest way to establish this limited bandwidth is to place an RC filter at the noninverting terminal of the amplifier, as Figure 36 shows.

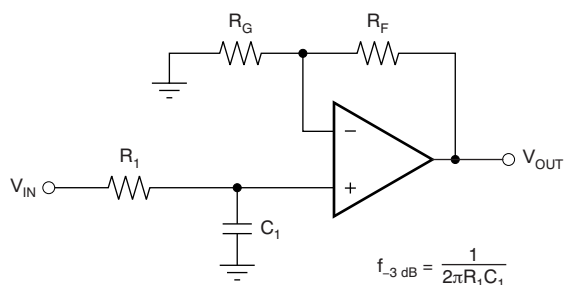

$$\frac{V_{\text{OUT}}}{V_{\text{IN}}} = \left(1 + \frac{R_F}{R_G}\right) \left(\frac{1}{1 + sR_1 C_1}\right)$$

**Figure 36. Single-Pole Low-Pass Filter**

If even more attenuation is needed, a multiple pole filter is required. The Sallen-Key filter can be used for this task, as Figure 37 shows. For best results, the amplifier should have a bandwidth that is eight to 10 times the filter frequency bandwidth. Failure to follow this guideline can result in phase shift of the amplifier.

Application Information (continued)

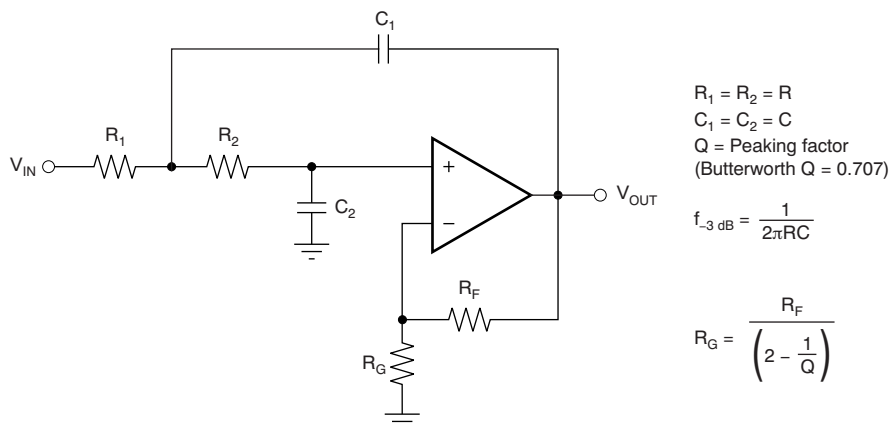

Figure 37. Two-Pole Low-Pass Sallen-Key Filter

8.1.2 Capacitive Load and Stability

The OPA2314 device is designed to be used in applications where driving a capacitive load is required. As with all op-amps, specific instances can occur where the OPA2314 device can become unstable. The particular op-amp circuit configuration, layout, gain, and output loading are some of the factors to consider when establishing whether or not an amplifier is stable in operation. An op-amp in the unity-gain (1 V/V) buffer configuration that drives a capacitive load exhibits a greater tendency to be unstable than an amplifier operated at a higher noise gain. The capacitive load, in conjunction with the op-amp output resistance, creates a pole within the feedback loop that degrades the phase margin. The degradation of the phase margin increases as the capacitive loading increases. When operating in the unity-gain configuration, the OPA2314 device remains stable with a pure capacitive load up to approximately 1 nF. The equivalent series resistance (ESR) of some very large capacitors ( $C_L$  greater than 1  $\mu\text{F}$ ) is sufficient to alter the phase characteristics in the feedback loop such that the amplifier remains stable. Increasing the amplifier closed-loop gain allows the amplifier to drive increasingly larger capacitance. This increased capability is evident when observing the overshoot response of the amplifier at higher voltage gains. See the graph, [Figure 20](#).

One technique for increasing the capacitive load drive capability of the amplifier operating in a unity-gain configuration is to insert a small resistor, typically 10  $\Omega$  to 20  $\Omega$ , in series with the output, as shown in [Figure 38](#). This resistor significantly reduces the overshoot and ringing associated with large capacitive loads. One possible problem with this technique, however, is that a voltage divider is created with the added series resistor and any resistor connected in parallel with the capacitive load. The voltage divider introduces a gain error at the output that reduces the output swing.

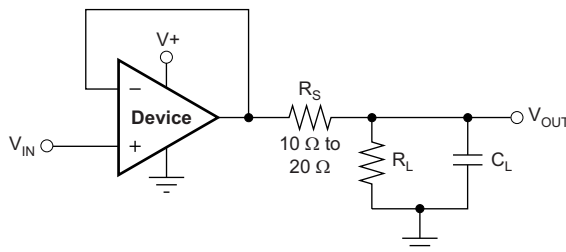
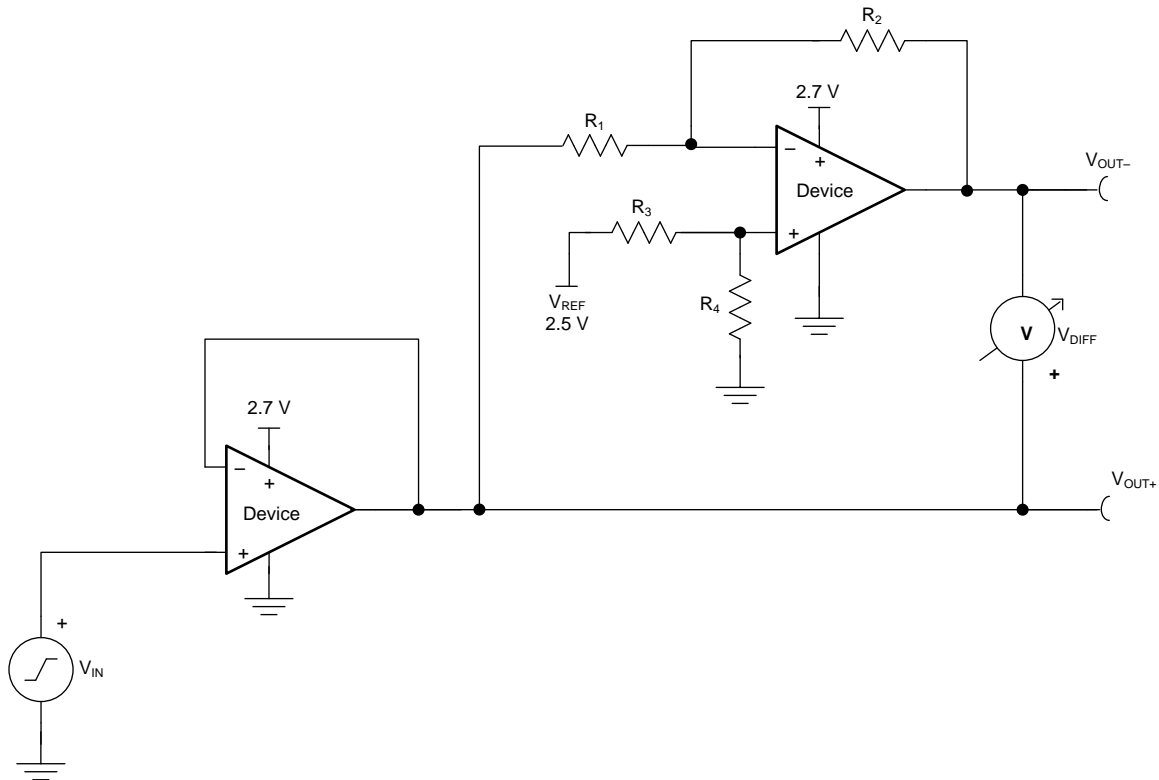

Figure 38. Improving Capacitive Load Drive

## 8.2 Typical Application

Some applications require differential signals. [Figure 39](#) shows a simple circuit to convert a single-ended input of 0.1 V to 2.4 V into a differential output of  $\pm 2.3$  V on a single 2.7-V supply. The output range is intentionally limited to maximize linearity. The circuit is composed of two amplifiers. One amplifier functions as a buffer and creates a voltage,  $V_{OUT+}$ . The second amplifier inverts the input and adds a reference voltage to generate  $V_{OUT-}$ . Both  $V_{OUT+}$  and  $V_{OUT-}$  range from 0.1 V to 2.4 V. The difference,  $V_{DIFF}$ , is the difference between  $V_{OUT+}$  and  $V_{OUT-}$ . This makes the differential output voltage range 2.3 V.



**Figure 39. Schematic for a Single-Ended Input to Differential Output Conversion**

### 8.2.1 Design Requirements

The design requirements are as follows:

- Supply voltage: 2.7 V
- Reference voltage: 2.5 V
- Input: 0.1 V to 2.4 V
- Output differential:  $\pm 2.3$  V
- Output common-mode voltage: 1.25 V
- Small-signal bandwidth: 1 MHz

### 8.2.2 Detailed Design Procedure

The circuit in [Figure 39](#) takes a single-ended input signal,  $V_{IN}$ , and generates two output signals,  $V_{OUT+}$  and  $V_{OUT-}$  using two amplifiers and a reference voltage,  $V_{REF}$ .  $V_{OUT+}$  is the output of the first amplifier and is a buffered version of the input signal,  $V_{IN}$  (as shown in [Equation 1](#)).  $V_{OUT-}$  is the output of the second amplifier which uses  $V_{REF}$  to add an offset voltage to  $V_{IN}$  and feedback to add inverting gain. The transfer function for  $V_{OUT-}$  is given in [Equation 2](#).

$$V_{OUT+} = V_{IN} \quad (1)$$

$$V_{OUT-} = V_{REF} \times \left( \frac{R_4}{R_3 + R_4} \right) \times \left( 1 + \frac{R_2}{R_1} \right) - V_{IN} \times \frac{R_2}{R_1} \quad (2)$$

### Typical Application (continued)

The differential output signal,  $V_{DIFF}$ , is the difference between the two single-ended output signals,  $V_{OUT+}$  and  $V_{OUT-}$ . Equation 3 shows the transfer function for  $V_{DIFF}$ . By applying the conditions that  $R_1 = R_2$  and  $R_3 = R_4$ , the transfer function is simplified into Equation 6. Using this configuration, the maximum input signal is equal to the reference voltage and the maximum output of each amplifier is equal to  $V_{REF}$ . The differential output range is  $2 \times V_{REF}$ . Furthermore, the common-mode voltage is one half of  $V_{REF}$  (see Equation 7).

$$V_{DIFF} = V_{OUT+} - V_{OUT-} = V_{IN} \times \left(1 + \frac{R_2}{R_1}\right) - V_{REF} \times \left(\frac{R_4}{R_3 + R_4}\right) \times \left(1 + \frac{R_2}{R_1}\right) \quad (3)$$

$$V_{OUT+} = V_{IN} \quad (4)$$

$$V_{OUT-} = V_{REF} - V_{IN} \quad (5)$$

$$V_{DIFF} = 2 \times V_{IN} - V_{REF} \quad (6)$$

$$V_{CM} = \left(\frac{V_{OUT+} + V_{OUT-}}{2}\right) = \frac{1}{2} V_{REF} \quad (7)$$

#### 8.2.2.1 Amplifier Selection

Linearity over the input range is key for good dc accuracy. The common-mode input range and output swing limitations determine the linearity. In general, an amplifier with rail-to-rail input and output swing is required. Bandwidth is a key concern for this design, so the OPA2314-Q1 device is selected because its bandwidth is greater than the target of 1 MHz. The bandwidth and power ratio makes this device power efficient and the low offset and drift ensure good accuracy for moderate precision applications.

#### 8.2.2.2 Passive Component Selection

Because the transfer function of  $V_{out-}$  is heavily reliant on resistors ( $R_1$ ,  $R_2$ ,  $R_3$ , and  $R_4$ ), use resistors with low tolerances to maximize performance and minimize error. This design uses resistors with resistance values of 49.9 k $\Omega$  and tolerances of 0.1%. However, if the noise of the system is a key parameter, smaller resistance values (6 k $\Omega$  or lower) can be selected to keep the overall system noise low. This ensures that the noise from the resistors is lower than the amplifier noise.

#### 8.2.3 Application Curves

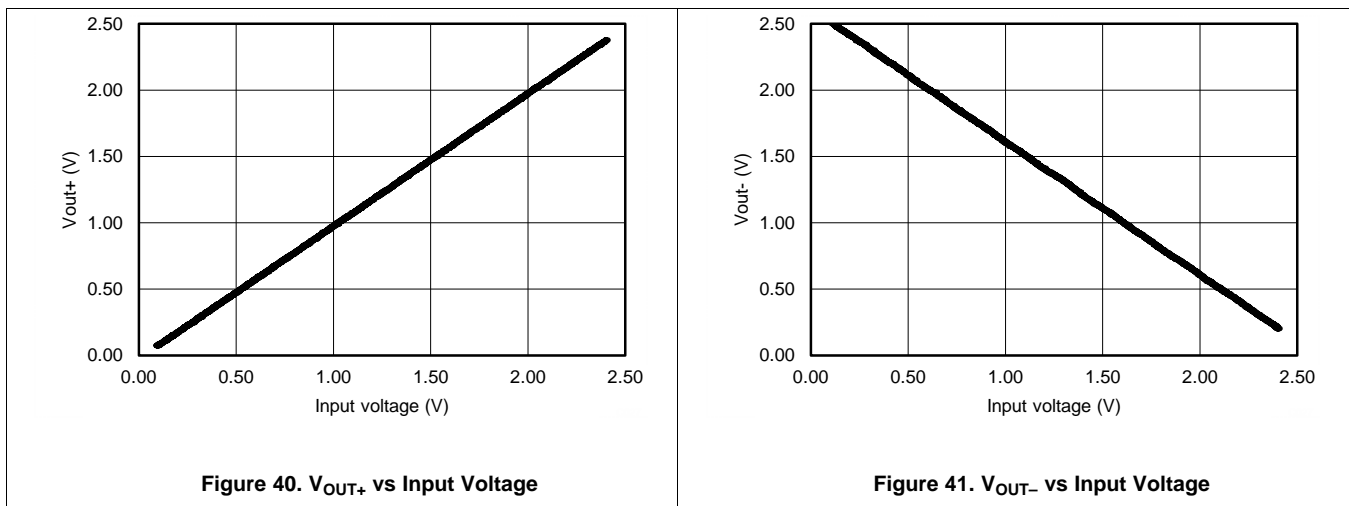

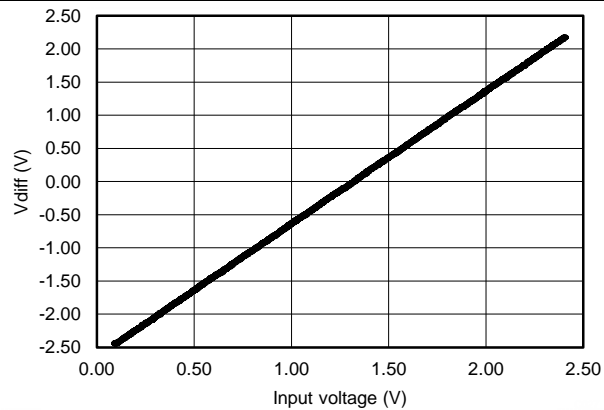
**Typical Application (continued)**

**Figure 42. V<sub>DIFF</sub> vs Input Voltage**
**9 Power Supply Recommendations**

The OPA2314-Q1 device is specified for operation from 1.8 V to 5.5 V ( $\pm 0.9$  V to  $\pm 2.75$  V); many specifications apply from  $-40^{\circ}\text{C}$  to  $125^{\circ}\text{C}$ . The [Typical Characteristics](#) presents parameters that can exhibit significant variance with regard to operating voltage or temperature.

**CAUTION**

Supply voltages larger than 7 V can permanently damage the device (see the [Absolute Maximum Ratings](#)).

Place 0.1- $\mu\text{F}$  bypass capacitors close to the power-supply pins to reduce errors coupling in from noisy or high-impedance power supplies. For more detailed information on bypass capacitor placement, refer to the [Layout Guidelines](#) section.



## 10 Layout

### 10.1 Layout Guidelines

For best operational performance of the device, use good PCB layout practices, including:

- Noise can propagate into analog circuitry through the power pins of the circuit as a whole and the operational amplifier. Bypass capacitors are used to reduce the coupled noise by providing low-impedance power sources local to the analog circuitry.
  - Connect low-ESR, 0.1- $\mu$ F ceramic bypass capacitors between each supply pin and ground, placed as close to the device as possible. A single bypass capacitor from V+ to ground is applicable for single-supply applications.
- Separate grounding for analog and digital portions of the circuitry is one of the simplest and most effective methods of noise suppression. One or more layers on multilayer PCBs are usually devoted to ground planes. A ground plane helps distribute heat and reduces EMI noise pickup. Make sure to physically separate digital and analog grounds, paying attention to the flow of the ground current. For more detailed information, refer to *Circuit Board Layout Techniques*, [SLOA089](#).
- To reduce parasitic coupling, run the input traces as far away from the supply or output traces as possible. If these traces cannot be kept separate, crossing the sensitive trace perpendicularly is much better than crossing in parallel with the noisy trace.
- Place the external components as close to the device as possible. Keeping RF and RG close to the inverting input minimizes parasitic capacitance, as shown in [Figure 43](#).
- Keep the length of input traces as short as possible. Always remember that the input traces are the most sensitive part of the circuit.
- Consider a driven, low-impedance guard ring around the critical traces. A guard ring can significantly reduce leakage currents from nearby traces that are at different potentials.

### 10.2 Layout Example

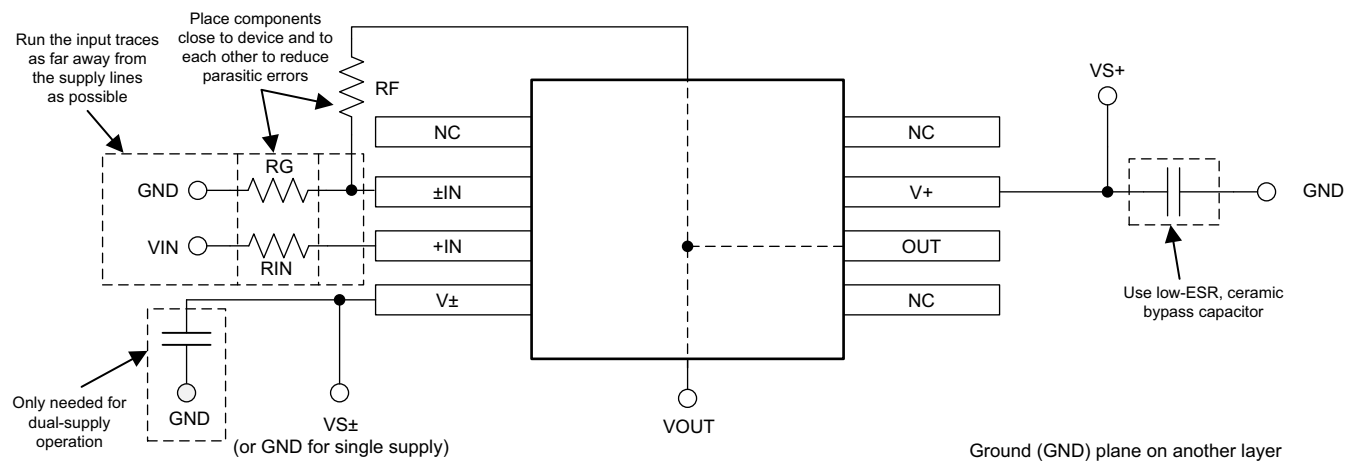
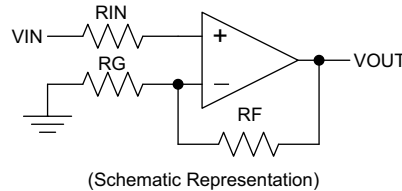

**Figure 43. Operational Amplifier Board Layout for Noninverting Configuration**

## 11 器件和文档支持

### 11.1 器件支持

#### 11.1.1 器件命名规则

##### 11.1.1.1 双边扁平无引线 (DFN) 封装

OPA2314 (双通道版本) 使用 DFN 类型封装 (也称为小外形尺寸无引线 (SON) 封装); 这个封装是只在封装底部两侧有接触点的四方扁平无引线 (QFN) 封装。这个无引线封装大大增加了印刷电路板 (PCB) 尺寸并且通过一个外露散热垫来提高散热和电气特性。DFN 封装的一个主要优势是其 0.9mm 的低高度。DFN 封装物理尺寸小, 具有更小的走线面积、改进的散热性能、减少的电气寄生, 并且使用一个与其它诸如小外形尺寸 (SO) 和微型小外形尺寸 (MSOP) 等常见封装一致的引脚分配机制。此外, 无外部引线也消除了引线弯曲问题的出现。

DFN 封装可使用标准 PCB 组装技巧轻松安装。请参见应用手册《QFN/SON PCB 附件》(文献编号: [SLUA271](#)) 和应用报告《四方扁平无引线逻辑封装》(文献编号: [SCBA017](#))。以上文献均可从 [www.ti.com](http://www.ti.com) 下载。

#### 注

DFN 封装底部的外露引线框下垫板应该被连接至最低负电压 (V-).

### 11.2 相关链接

以下表格列出了快速访问链接。范围包括技术文档、支持与社区资源、工具和软件, 并且可以快速访问样片或购买链接。

表 2. 相关链接

器件	产品文件夹	样片与购买	技术文章	工具与软件	支持与社区
OPA314	<a href="#">请单击此处</a>	<a href="#">请单击此处</a>	<a href="#">请单击此处</a>	<a href="#">请单击此处</a>	<a href="#">请单击此处</a>
OPA2314	<a href="#">请单击此处</a>	<a href="#">请单击此处</a>	<a href="#">请单击此处</a>	<a href="#">请单击此处</a>	<a href="#">请单击此处</a>
OPA4314	<a href="#">请单击此处</a>	<a href="#">请单击此处</a>	<a href="#">请单击此处</a>	<a href="#">请单击此处</a>	<a href="#">请单击此处</a>

### 11.3 社区资源

The following links connect to TI community resources. Linked contents are provided "AS IS" by the respective contributors. They do not constitute TI specifications and do not necessarily reflect TI's views; see TI's [Terms of Use](#).

**TI E2E™ Online Community** *TI's Engineer-to-Engineer (E2E) Community*. Created to foster collaboration among engineers. At [e2e.ti.com](http://e2e.ti.com), you can ask questions, share knowledge, explore ideas and help solve problems with fellow engineers.

**Design Support** *TI's Design Support* Quickly find helpful E2E forums along with design support tools and contact information for technical support.

### 11.4 商标

E2E is a trademark of Texas Instruments.

All other trademarks are the property of their respective owners.

### 11.5 静电放电警告



这些装置包含有限的内置 ESD 保护。存储或装卸时, 应将导线一起截短或将装置放置于导电泡棉中, 以防止 MOS 门极遭受静电损伤。

### 11.6 Glossary

[SLYZ022](#) — *TI Glossary*.

This glossary lists and explains terms, acronyms, and definitions.

## 12 机械、封装和可订购信息

以下页中包括机械、封装和可订购信息。这些信息是针对指定器件可提供的最新数据。这些数据会在无通知且不对本文档进行修订的情况下发生改变。欲获得该数据表的浏览器版本，请查阅左侧的导航栏。

## 重要声明

德州仪器(TI)及其下属子公司有权根据 JESD46 最新标准,对所提供的产品和服务进行更正、修改、增强、改进或其它更改,并有权根据 JESD48 最新标准中止提供任何产品和服务。客户在下订单前应获取最新的相关信息,并验证这些信息是否完整且是最新的。所有产品的销售都遵循在订单确认时所提供的TI 销售条款与条件。

TI 保证其所销售的组件的性能符合产品销售时 TI 半导体产品销售条件与条款的适用规范。仅在 TI 保证的范围内,且 TI 认为有必要时才会使用测试或其它质量控制技术。除非适用法律做出了硬性规定,否则没有必要对每种组件的所有参数进行测试。

TI 对应用帮助或客户产品设计不承担任何义务。客户应对其使用 TI 组件的产品和应用自行负责。为尽量减小与客户产品和应用相关的风险,客户应提供充分的设计与操作安全措施。

TI 不对任何 TI 专利权、版权、屏蔽作品权或其它与使用了 TI 组件或服务的组合设备、机器或流程相关的 TI 知识产权中授予的直接或隐含权限作出任何保证或解释。TI 所发布的与第三方产品或服务有关的信息,不能构成从 TI 获得使用这些产品或服务的许可、授权、或认可。使用此类信息可能需要获得第三方的专利权或其它知识产权方面的许可,或是 TI 的专利权或其它知识产权方面的许可。

对于 TI 的产品手册或数据表中 TI 信息的重要部分,仅在没有对内容进行任何篡改且带有相关授权、条件、限制和声明的情况下才允许进行复制。TI 对此类篡改过的文件不承担任何责任或义务。复制第三方的信息可能需要服从额外的限制条件。

在转售 TI 组件或服务时,如果对该组件或服务参数的陈述与 TI 标明的参数相比存在差异或虚假成分,则会失去相关 TI 组件或服务的所有明示或暗示授权,且这是不正当的、欺诈性商业行为。TI 对任何此类虚假陈述均不承担任何责任或义务。

客户认可并同意,尽管任何应用相关信息或支持仍可能由 TI 提供,但他们将独立负责满足与其产品及其在应用中使用的 TI 产品相关的所有法律、法规和安全相关要求。客户声明并同意,他们具备制定与实施安全措施所需的全部专业技术和知识,可预见故障的危险后果、监测故障及其后果、降低有可能造成人身伤害的故障的发生机率并采取适当的补救措施。客户将全额赔偿因在此类安全关键应用中使用任何 TI 组件而对 TI 及其代理造成的任何损失。

在某些场合中,为了推进安全相关应用有可能对 TI 组件进行特别的促销。TI 的目标是利用此类组件帮助客户设计和创立其特有的可满足适用的功能安全性标准和要求的终端产品解决方案。尽管如此,此类组件仍然服从这些条款。

TI 组件未获得用于 FDA Class III (或类似的生命攸关医疗设备)的授权许可,除非各方授权官员已经达成了专门管控此类使用的特别协议。

只有那些 TI 特别注明属于军用等级或“增强型塑料”的 TI 组件才是设计或专门用于军事/航空应用或环境的。购买者认可并同意,对并非指定面向军事或航空航天用途的 TI 组件进行军事或航空航天方面的应用,其风险由客户单独承担,并且由客户独立负责满足与此类使用相关的所有法律和法规要求。

TI 已明确指定符合 ISO/TS16949 要求的产品,这些产品主要用于汽车。在任何情况下,因使用非指定产品而无法达到 ISO/TS16949 要求, TI 不承担任何责任。

	产品		应用
数字音频	<a href="http://www.ti.com.cn/audio">www.ti.com.cn/audio</a>	通信与电信	<a href="http://www.ti.com.cn/telecom">www.ti.com.cn/telecom</a>
放大器和线性器件	<a href="http://www.ti.com.cn/amplifiers">www.ti.com.cn/amplifiers</a>	计算机及周边	<a href="http://www.ti.com.cn/computer">www.ti.com.cn/computer</a>
数据转换器	<a href="http://www.ti.com.cn/dataconverters">www.ti.com.cn/dataconverters</a>	消费电子	<a href="http://www.ti.com.cn/consumer-apps">www.ti.com.cn/consumer-apps</a>
DLP® 产品	<a href="http://www.dlp.com">www.dlp.com</a>	能源	<a href="http://www.ti.com.cn/energy">www.ti.com.cn/energy</a>
DSP - 数字信号处理器	<a href="http://www.ti.com.cn/dsp">www.ti.com.cn/dsp</a>	工业应用	<a href="http://www.ti.com.cn/industrial">www.ti.com.cn/industrial</a>
时钟和计时器	<a href="http://www.ti.com.cn/clockandtimers">www.ti.com.cn/clockandtimers</a>	医疗电子	<a href="http://www.ti.com.cn/medical">www.ti.com.cn/medical</a>
接口	<a href="http://www.ti.com.cn/interface">www.ti.com.cn/interface</a>	安防应用	<a href="http://www.ti.com.cn/security">www.ti.com.cn/security</a>
逻辑	<a href="http://www.ti.com.cn/logic">www.ti.com.cn/logic</a>	汽车电子	<a href="http://www.ti.com.cn/automotive">www.ti.com.cn/automotive</a>
电源管理	<a href="http://www.ti.com.cn/power">www.ti.com.cn/power</a>	视频和影像	<a href="http://www.ti.com.cn/video">www.ti.com.cn/video</a>
微控制器 (MCU)	<a href="http://www.ti.com.cn/microcontrollers">www.ti.com.cn/microcontrollers</a>		
RFID 系统	<a href="http://www.ti.com.cn/rfidsys">www.ti.com.cn/rfidsys</a>		
OMAP应用处理器	<a href="http://www.ti.com/omap">www.ti.com/omap</a>		
无线连通性	<a href="http://www.ti.com.cn/wirelessconnectivity">www.ti.com.cn/wirelessconnectivity</a>	德州仪器在线技术支持社区	<a href="http://www.deyisupport.com">www.deyisupport.com</a>

邮寄地址: 上海市浦东新区世纪大道1568号, 中建大厦32楼邮政编码: 200122  
Copyright © 2016, 德州仪器半导体技术(上海)有限公司

**PACKAGING INFORMATION**

Orderable Device	Status (1)	Package Type	Package Drawing	Pins	Package Qty	Eco Plan (2)	Lead/Ball Finish (6)	MSL Peak Temp (3)	Op Temp (°C)	Device Marking (4/5)	Samples
OPA2314AID	ACTIVE	SOIC	D	8	75	Green (RoHS & no Sb/Br)	NIPDAU	Level-2-260C-1 YEAR	-40 to 125	O2314	<a href="#">Samples</a>
OPA2314AIDGK	ACTIVE	VSSOP	DGK	8	80	Green (RoHS & no Sb/Br)	NIPDAUAG	Level-2-260C-1 YEAR	-40 to 125	OCPQ	<a href="#">Samples</a>
OPA2314AIDGKR	ACTIVE	VSSOP	DGK	8	2500	Green (RoHS & no Sb/Br)	NIPDAUAG	Level-2-260C-1 YEAR	-40 to 125	OCPQ	<a href="#">Samples</a>
OPA2314AIDR	ACTIVE	SOIC	D	8	2500	Green (RoHS & no Sb/Br)	NIPDAU	Level-2-260C-1 YEAR	-40 to 125	O2314	<a href="#">Samples</a>
OPA2314AIDRBR	ACTIVE	SON	DRB	8	3000	Green (RoHS & no Sb/Br)	NIPDAU	Level-2-260C-1 YEAR	-40 to 125	QXY	<a href="#">Samples</a>
OPA2314AIDRBT	ACTIVE	SON	DRB	8	250	Green (RoHS & no Sb/Br)	NIPDAU	Level-2-260C-1 YEAR	-40 to 125	QXY	<a href="#">Samples</a>
OPA314AIDBVR	ACTIVE	SOT-23	DBV	5	3000	Green (RoHS & no Sb/Br)	NIPDAU	Level-2-260C-1 YEAR	-40 to 125	RAZ	<a href="#">Samples</a>
OPA314AIDBVT	ACTIVE	SOT-23	DBV	5	250	Green (RoHS & no Sb/Br)	NIPDAU	Level-2-260C-1 YEAR	-40 to 125	RAZ	<a href="#">Samples</a>
OPA314AIDCKR	ACTIVE	SC70	DCK	5	3000	Green (RoHS & no Sb/Br)	NIPDAU	Level-1-260C-UNLIM	-40 to 125	SAA	<a href="#">Samples</a>
OPA314AIDCKT	ACTIVE	SC70	DCK	5	250	Green (RoHS & no Sb/Br)	NIPDAU	Level-1-260C-UNLIM	-40 to 125	SAA	<a href="#">Samples</a>
OPA4314AIPW	ACTIVE	TSSOP	PW	14	90	Green (RoHS & no Sb/Br)	NIPDAU	Level-2-260C-1 YEAR	-40 to 125	OPA4314	<a href="#">Samples</a>
OPA4314AIPWR	ACTIVE	TSSOP	PW	14	2000	Green (RoHS & no Sb/Br)	NIPDAU	Level-2-260C-1 YEAR	-40 to 125	OPA4314	<a href="#">Samples</a>

(1) The marketing status values are defined as follows:

**ACTIVE:** Product device recommended for new designs.

**LIFEBUY:** TI has announced that the device will be discontinued, and a lifetime-buy period is in effect.

**NRND:** Not recommended for new designs. Device is in production to support existing customers, but TI does not recommend using this part in a new design.

**PREVIEW:** Device has been announced but is not in production. Samples may or may not be available.

**OBSELETE:** TI has discontinued the production of the device.

(2) **RoHS:** TI defines "RoHS" to mean semiconductor products that are compliant with the current EU RoHS requirements for all 10 RoHS substances, including the requirement that RoHS substance do not exceed 0.1% by weight in homogeneous materials. Where designed to be soldered at high temperatures, "RoHS" products are suitable for use in specified lead-free processes. TI may reference these types of products as "Pb-Free".

**RoHS Exempt:** TI defines "RoHS Exempt" to mean products that contain lead but are compliant with EU RoHS pursuant to a specific EU RoHS exemption.

**Green:** TI defines "Green" to mean the content of Chlorine (Cl) and Bromine (Br) based flame retardants meet JS709B low halogen requirements of  $\leq 1000$ ppm threshold. Antimony trioxide based flame retardants must also meet the  $\leq 1000$ ppm threshold requirement.

(3) MSL, Peak Temp. - The Moisture Sensitivity Level rating according to the JEDEC industry standard classifications, and peak solder temperature.

(4) There may be additional marking, which relates to the logo, the lot trace code information, or the environmental category on the device.

(5) Multiple Device Markings will be inside parentheses. Only one Device Marking contained in parentheses and separated by a "~" will appear on a device. If a line is indented then it is a continuation of the previous line and the two combined represent the entire Device Marking for that device.

(6) Lead/Ball Finish - Orderable Devices may have multiple material finish options. Finish options are separated by a vertical ruled line. Lead/Ball Finish values may wrap to two lines if the finish value exceeds the maximum column width.

**Important Information and Disclaimer:** The information provided on this page represents TI's knowledge and belief as of the date that it is provided. TI bases its knowledge and belief on information provided by third parties, and makes no representation or warranty as to the accuracy of such information. Efforts are underway to better integrate information from third parties. TI has taken and continues to take reasonable steps to provide representative and accurate information but may not have conducted destructive testing or chemical analysis on incoming materials and chemicals. TI and TI suppliers consider certain information to be proprietary, and thus CAS numbers and other limited information may not be available for release.

In no event shall TI's liability arising out of such information exceed the total purchase price of the TI part(s) at issue in this document sold by TI to Customer on an annual basis.

## TAPE AND REEL INFORMATION



### QUADRANT ASSIGNMENTS FOR PIN 1 ORIENTATION IN TAPE



\*All dimensions are nominal

Device	Package Type	Package Drawing	Pins	SPQ	Reel Diameter (mm)	Reel Width W1 (mm)	A0 (mm)	B0 (mm)	K0 (mm)	P1 (mm)	W (mm)	Pin1 Quadrant
OPA2314AIDGKR	VSSOP	DGK	8	2500	330.0	12.4	5.3	3.4	1.4	8.0	12.0	Q1
OPA2314AIDR	SOIC	D	8	2500	330.0	12.4	6.4	5.2	2.1	8.0	12.0	Q1
OPA2314AIDRBR	SON	DRB	8	3000	330.0	12.4	3.3	3.3	1.1	8.0	12.0	Q2
OPA2314AIDRBT	SON	DRB	8	250	180.0	12.4	3.3	3.3	1.1	8.0	12.0	Q2
OPA314AIDBVR	SOT-23	DBV	5	3000	178.0	9.0	3.3	3.2	1.4	4.0	8.0	Q3
OPA314AIDBVT	SOT-23	DBV	5	250	178.0	9.0	3.23	3.17	1.37	4.0	8.0	Q3
OPA314AIDCKR	SC70	DCK	5	3000	178.0	9.0	2.4	2.5	1.2	4.0	8.0	Q3
OPA4314AIPWR	TSSOP	PW	14	2000	330.0	12.4	6.9	5.6	1.6	8.0	12.0	Q1

**TAPE AND REEL BOX DIMENSIONS**

\*All dimensions are nominal

Device	Package Type	Package Drawing	Pins	SPQ	Length (mm)	Width (mm)	Height (mm)
OPA2314AIDGKR	VSSOP	DGK	8	2500	366.0	364.0	50.0
OPA2314AIDR	SOIC	D	8	2500	367.0	367.0	35.0
OPA2314AIDRBR	SON	DRB	8	3000	367.0	367.0	35.0
OPA2314AIDRBT	SON	DRB	8	250	210.0	185.0	35.0
OPA314AIDBVR	SOT-23	DBV	5	3000	180.0	180.0	18.0
OPA314AIDBVT	SOT-23	DBV	5	250	180.0	180.0	18.0
OPA314AIDCKR	SC70	DCK	5	3000	180.0	180.0	18.0
OPA4314AIPWR	TSSOP	PW	14	2000	367.0	367.0	35.0



DCK (R-PDSO-G5)

PLASTIC SMALL-OUTLINE PACKAGE



- NOTES:
- A. All linear dimensions are in millimeters.
  - B. This drawing is subject to change without notice.
  - C. Body dimensions do not include mold flash or protrusion. Mold flash and protrusion shall not exceed 0.15 per side.
  - D. Falls within JEDEC MO-203 variation AA.

DCK (R-PDSO-G5)

PLASTIC SMALL OUTLINE



- NOTES:
- A. All linear dimensions are in millimeters.
  - B. This drawing is subject to change without notice.
  - C. Customers should place a note on the circuit board fabrication drawing not to alter the center solder mask defined pad.
  - D. Publication IPC-7351 is recommended for alternate designs.
  - E. Laser cutting apertures with trapezoidal walls and also rounding corners will offer better paste release. Customers should contact their board assembly site for stencil design recommendations. Example stencil design based on a 50% volumetric metal load solder paste. Refer to IPC-7525 for other stencil recommendations.

**DRB 8**

**GENERIC PACKAGE VIEW**

**VSON - 1 mm max height**

PLASTIC SMALL OUTLINE - NO LEAD



Images above are just a representation of the package family, actual package may vary.  
Refer to the product data sheet for package details.

4203482/L

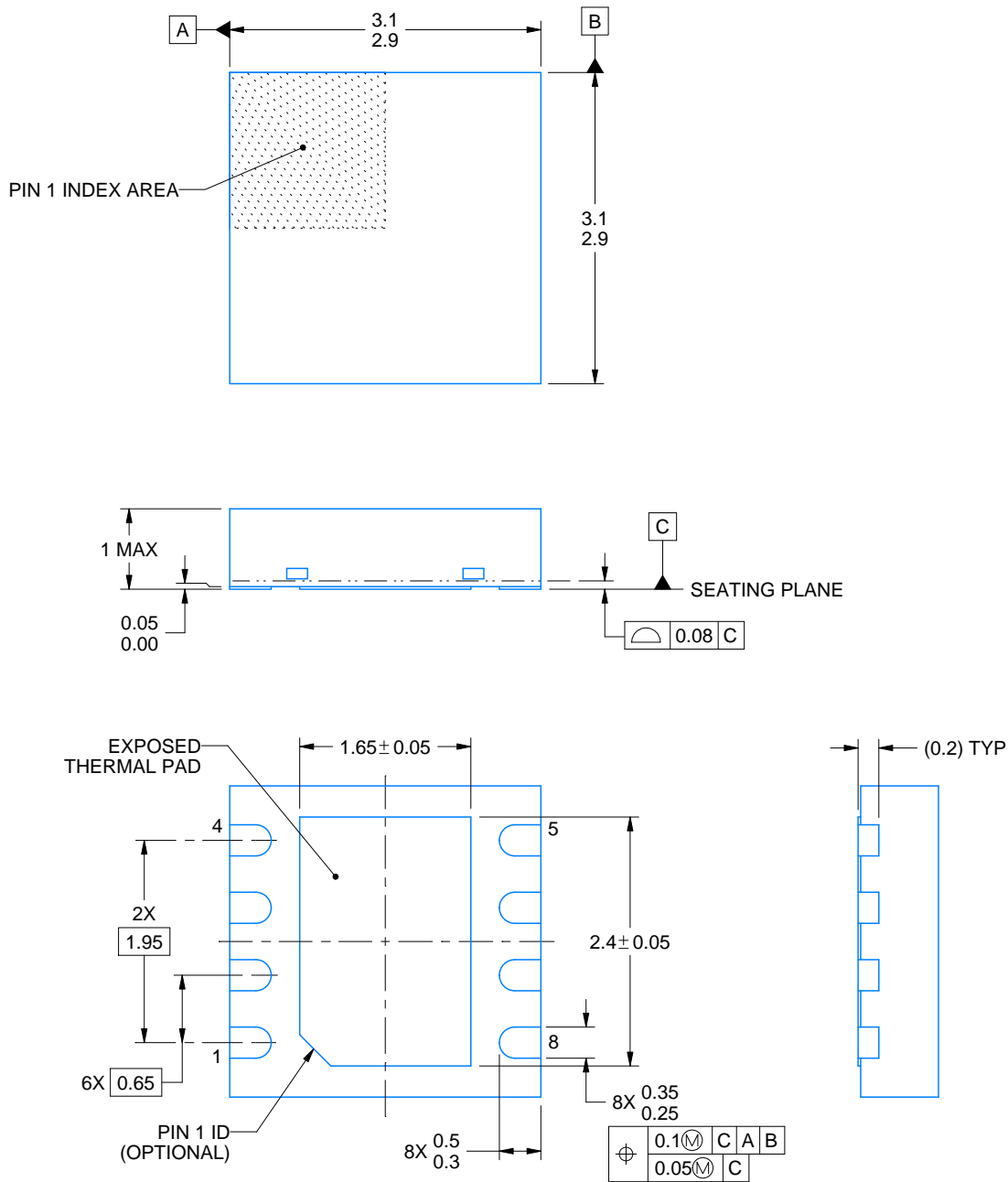

4218876/A 12/2017

NOTES:

1. All linear dimensions are in millimeters. Any dimensions in parenthesis are for reference only. Dimensioning and tolerancing per ASME Y14.5M.
2. This drawing is subject to change without notice.
3. The package thermal pad must be soldered to the printed circuit board for thermal and mechanical performance.

# EXAMPLE BOARD LAYOUT

DRB0008B

VSON - 1 mm max height

PLASTIC SMALL OUTLINE - NO LEAD



LAND PATTERN EXAMPLE  
SCALE:20X



SOLDER MASK DETAILS

4218876/A 12/2017

NOTES: (continued)

4. This package is designed to be soldered to a thermal pad on the board. For more information, see Texas Instruments literature number SLUA271 ([www.ti.com/lit/sluea271](http://www.ti.com/lit/sluea271)).
5. Vias are optional depending on application, refer to device data sheet. If any vias are implemented, refer to their locations shown on this view. It is recommended that vias under paste be filled, plugged or tented.

# EXAMPLE STENCIL DESIGN

DRB0008B

VSON - 1 mm max height

PLASTIC SMALL OUTLINE - NO LEAD



SOLDER PASTE EXAMPLE  
BASED ON 0.125 mm THICK STENCIL

EXPOSED PAD  
81% PRINTED SOLDER COVERAGE BY AREA  
SCALE:25X

4218876/A 12/2017

NOTES: (continued)

6. Laser cutting apertures with trapezoidal walls and rounded corners may offer better paste release. IPC-7525 may have alternate design recommendations.

DBV0005A



# PACKAGE OUTLINE

SOT-23 - 1.45 mm max height

SMALL OUTLINE TRANSISTOR

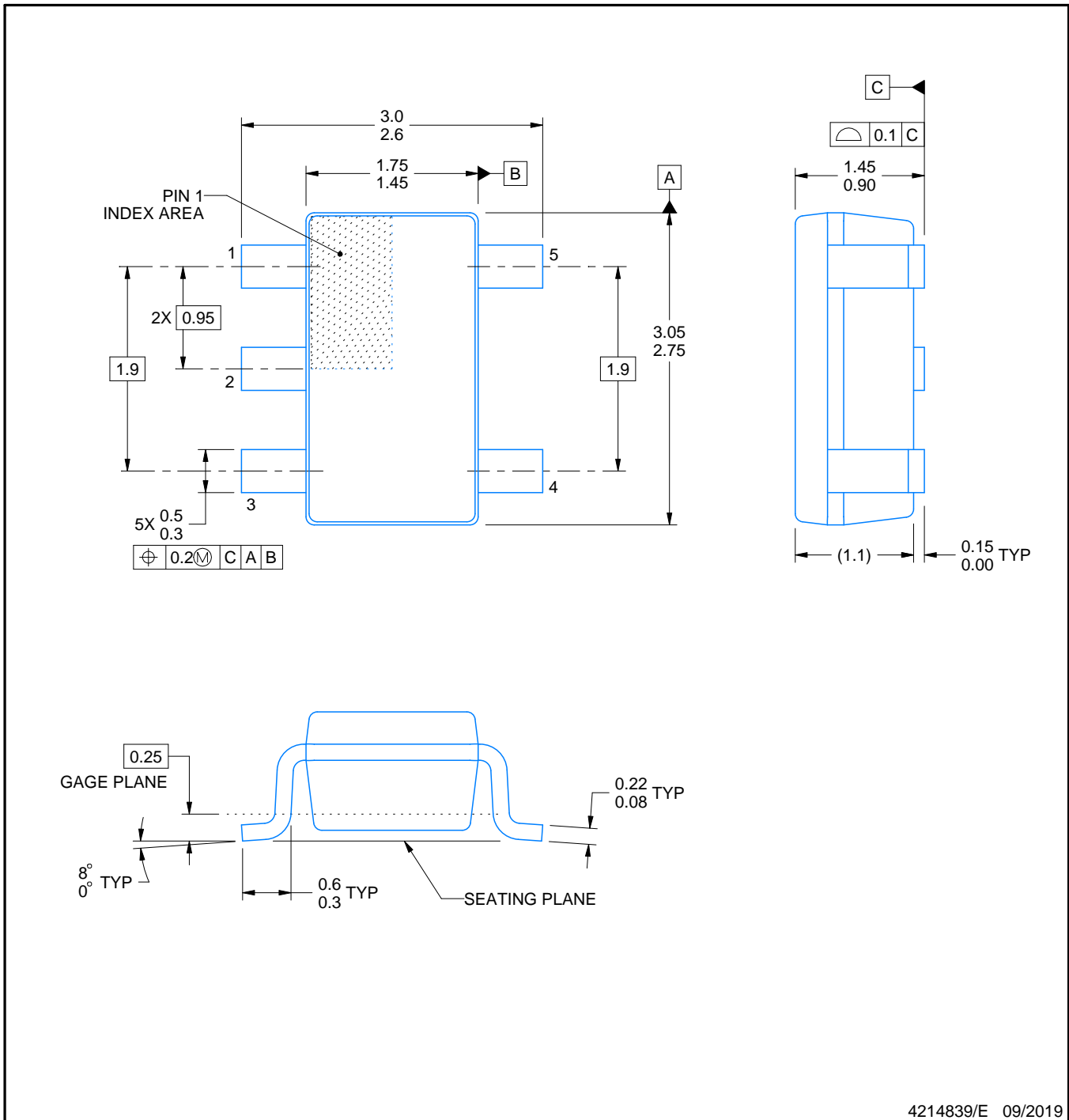

4214839/E 09/2019

## NOTES:

1. All linear dimensions are in millimeters. Any dimensions in parenthesis are for reference only. Dimensioning and tolerancing per ASME Y14.5M.
2. This drawing is subject to change without notice.
3. Reference JEDEC MO-178.
4. Body dimensions do not include mold flash, protrusions, or gate burrs. Mold flash, protrusions, or gate burrs shall not exceed 0.15 mm per side.

# EXAMPLE BOARD LAYOUT

DBV0005A

SOT-23 - 1.45 mm max height

SMALL OUTLINE TRANSISTOR



LAND PATTERN EXAMPLE  
EXPOSED METAL SHOWN  
SCALE:15X



SOLDER MASK DETAILS

4214839/E 09/2019

NOTES: (continued)

- 5. Publication IPC-7351 may have alternate designs.
- 6. Solder mask tolerances between and around signal pads can vary based on board fabrication site.



# EXAMPLE STENCIL DESIGN

DBV0005A

SOT-23 - 1.45 mm max height

SMALL OUTLINE TRANSISTOR



SOLDER PASTE EXAMPLE  
BASED ON 0.125 mm THICK STENCIL  
SCALE:15X

4214839/E 09/2019

NOTES: (continued)

7. Laser cutting apertures with trapezoidal walls and rounded corners may offer better paste release. IPC-7525 may have alternate design recommendations.
8. Board assembly site may have different recommendations for stencil design.

DGK (S-PDSO-G8)

PLASTIC SMALL-OUTLINE PACKAGE



- NOTES:
- A. All linear dimensions are in millimeters.
  - B. This drawing is subject to change without notice.
  - $\nabla$  C Body length does not include mold flash, protrusions, or gate burrs. Mold flash, protrusions, or gate burrs shall not exceed 0.15 per end.
  - $\nabla$  D Body width does not include interlead flash. Interlead flash shall not exceed 0.50 per side.
  - E. Falls within JEDEC MO-187 variation AA, except interlead flash.





- NOTES:
- A. All linear dimensions are in millimeters.
  - B. This drawing is subject to change without notice.
  - C. Publication IPC-7351 is recommended for alternate designs.
  - D. Laser cutting apertures with trapezoidal walls and also rounding corners will offer better paste release. Customers should contact their board assembly site for stencil design recommendations. Refer to IPC-7525 for other stencil recommendations.
  - E. Customers should contact their board fabrication site for solder mask tolerances between and around signal pads.

PW (R-PDSO-G14)

PLASTIC SMALL OUTLINE



- NOTES:
- A. All linear dimensions are in millimeters. Dimensioning and tolerancing per ASME Y14.5M-1994.
  - B. This drawing is subject to change without notice.
  -  Body length does not include mold flash, protrusions, or gate burrs. Mold flash, protrusions, or gate burrs shall not exceed 0,15 each side.
  -  Body width does not include interlead flash. Interlead flash shall not exceed 0,25 each side.
  - E. Falls within JEDEC MO-153

PW (R-PDSO-G14)

PLASTIC SMALL OUTLINE



4211284-2/G 08/15

- NOTES:
- All linear dimensions are in millimeters.
  - This drawing is subject to change without notice.
  - Publication IPC-7351 is recommended for alternate designs.
  - Laser cutting apertures with trapezoidal walls and also rounding corners will offer better paste release. Customers should contact their board assembly site for stencil design recommendations. Refer to IPC-7525 for other stencil recommendations.
  - Customers should contact their board fabrication site for solder mask tolerances between and around signal pads.



D0008A

# PACKAGE OUTLINE

SOIC - 1.75 mm max height

SMALL OUTLINE INTEGRATED CIRCUIT



4214825/C 02/2019

### NOTES:

1. Linear dimensions are in inches [millimeters]. Dimensions in parenthesis are for reference only. Controlling dimensions are in inches. Dimensioning and tolerancing per ASME Y14.5M.
2. This drawing is subject to change without notice.
3. This dimension does not include mold flash, protrusions, or gate burrs. Mold flash, protrusions, or gate burrs shall not exceed  $.006$  [0.15] per side.
4. This dimension does not include interlead flash.
5. Reference JEDEC registration MS-012, variation AA.

# EXAMPLE BOARD LAYOUT

D0008A

SOIC - 1.75 mm max height

SMALL OUTLINE INTEGRATED CIRCUIT



LAND PATTERN EXAMPLE  
EXPOSED METAL SHOWN  
SCALE:8X



SOLDER MASK DETAILS

4214825/C 02/2019

NOTES: (continued)

6. Publication IPC-7351 may have alternate designs.

7. Solder mask tolerances between and around signal pads can vary based on board fabrication site.

# EXAMPLE STENCIL DESIGN

D0008A

SOIC - 1.75 mm max height

SMALL OUTLINE INTEGRATED CIRCUIT



SOLDER PASTE EXAMPLE  
BASED ON .005 INCH [0.125 MM] THICK STENCIL  
SCALE:8X

4214825/C 02/2019

NOTES: (continued)

8. Laser cutting apertures with trapezoidal walls and rounded corners may offer better paste release. IPC-7525 may have alternate design recommendations.
9. Board assembly site may have different recommendations for stencil design.



## 重要声明和免责声明

TI 均以“原样”提供技术性及其可靠性数据（包括数据表）、设计资源（包括参考设计）、应用或其他设计建议、网络工具、安全信息和其他资源，不保证其中不含任何瑕疵，且不做任何明示或暗示的担保，包括但不限于对适销性、适合某特定用途或不侵犯任何第三方知识产权的暗示担保。

所述资源可供专业开发人员应用TI 产品进行设计使用。您将对以下行为独自承担全部责任：(1) 针对您的应用选择合适的TI 产品；(2) 设计、验证并测试您的应用；(3) 确保您的应用满足相应标准以及任何其他安全、安保或其他要求。所述资源如有变更，恕不另行通知。TI 对您使用所述资源的授权仅限于开发资源所涉及TI 产品的相关应用。除此之外不得复制或展示所述资源，也不提供其它TI 或任何第三方的知识产权授权许可。如因使用所述资源而产生任何索赔、赔偿、成本、损失及债务等，TI 对此概不负责，并且您须赔偿由此对TI 及其代表造成的损害。

TI 所提供产品均受TI 的销售条款 (<http://www.ti.com.cn/zh-cn/legal/termsofsale.html>) 以及ti.com.cn 上或随附TI 产品提供的其他可适用条款的约束。TI 提供所述资源并不扩展或以其他方式更改TI 针对TI 产品所发布的可适用的担保范围或担保免责声明。

邮寄地址：上海市浦东新区世纪大道 1568 号中建大厦 32 楼，邮政编码：200122

Copyright © 2020 德州仪器半导体技术（上海）有限公司