

Power TVS in DO-201AD

Features

- 1500Watts peak pulse power (10/1000 μ s)
- Class passivated junction
- High accuracy, 5% tolerance
- Uni and Bidirectional unit
- Low clamping voltage
- Low Leakage current
- Very fast response time

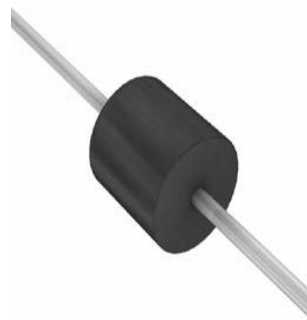

Mechanical Data

- **Case:** DO-201AD (plastic package).
Lead free; RoHS compliant
- **Molding Compound Flammability Rating:**
UL 94 V-0
- **Terminals:** High temperature soldering guaranteed:
260 °C/10 sec. at terminals

Applications

- Computers
- Telecom systems
- Industrial equipments
- Consumer electronic applications
- Other VCC bus and I/O interfaces

Absolute Maximum Ratings

Ratings at 25 °C, ambient temperature unless otherwise specified

Parameter	Symbols	Value	Unit
Peak power dissipation with a 10/1000us waveform ⁽¹⁾ (Fig. 1)	P _{PPM}	1500	W
Peak pulse current with a 10/1000us waveform ⁽¹⁾	I _{PPM}	See Next Table	A
Steady state power dissipation at T _L =75°C, lead lengths 0.375" (9.5mm) ⁽²⁾	P _{M(AV)}	6.5	W
Peak forward surge current 8.3ms single half sine-wave ⁽³⁾	I _{FSM}	200	A
Maximum instantaneous forward voltage @ 50A for unidirectional only ⁽⁴⁾	V _F	3.5/5.0	V
Typical thermal resistance junction-to-lead	R _{θJL}	20	°C/W
Typical thermal resistance junction-to-ambient	R _{θJA}	75	°C/W
Operating junction and storage temperature range	T _J , T _{STG}	-55 to +150	°C

Notes:1.Non-repetitive current pulse, per Fig.3 and derated above T_A=25°C per Fig. 2

2. Mounted on copper pad area of 1.6 x 1.6" (40 x 40mm) per Fig. 5

3. Meas ed on 8.3ms single half sine-wave or equivalent square wave, duty cycle = 4 pulses per minute maximum

4. V_F=3.5 V for devices of V_(BR) < 220V, and V_F=5.0 Volt max. for devices of V_(BR)>220V

Electrical Characteristics

(T_A=25°C, Unless otherwise specified.)

Device type		Breakdown voltage V _(BR) (Volts) ⁽¹⁾		Test current at I _T (mA)	Stand-off voltage V _{WM} (Volts)	Maximum reverse leakage at V _{WM} I _D ⁽⁴⁾ (μA)	Maximum peak pulse current I _{PPM} ⁽²⁾ (A)	Maximum clamping voltage at I _{PPM} V _C (Volts)	Maximum temperature coefficient of V _{BR} (% /°C)
		Min.	Max.						
1.5KE6.8A	1.5KE6.8CA	6.45	7.14	10	5.80	1000	143	10.5	0.057
1.5KE7.5A	1.5KE7.5CA	7.13	7.88	10	6.40	500	133	11.3	0.061
1.5KE8.2A	1.5KE8.2CA	7.79	8.61	10	7.02	200	124	12.1	0.065
1.5KE9.1A	1.5KE9.1CA	8.65	9.55	1.0	7.78	50	112	13.4	0.068
1.5KE10A	1.5KE10CA	9.50	10.5	1.0	8.55	10	103	14.5	0.073
1.5KE11A	1.5KE11CA	10.5	11.6	1.0	9.40	5.0	96.2	15.6	0.075
1.5KE12A	1.5KE12CA	11.4	12.6	1.0	10.2	5.0	89.8	16.7	0.078
1.5KE13A	1.5KE13CA	12.4	13.7	1.0	11.1	5.0	82.4	18.2	0.081
1.5KE15A	1.5KE15CA	14.3	15.8	1.0	12.8	1.0	70.8	21.2	0.084
1.5KE16A	1.5KE16CA	15.2	16.8	1.0	13.6	1.0	66.7	22.5	0.086
1.5KE18A	1.5KE18CA	17.1	18.9	1.0	15.3	1.0	59.5	25.2	0.088
1.5KE20A	1.5KE20CA	19.0	21.0	1.0	17.1	1.0	54.2	27.7	0.090
1.5KE22A	1.5KE22CA	20.9	23.1	1.0	18.8	1.0	49.0	30.6	0.092
1.5KE24A	1.5KE24CA	22.8	25.2	1.0	20.5	1.0	45.2	33.2	0.094
1.5KE27A	1.5KE27CA	25.7	28.4	1.0	23.1	1.0	40.0	37.5	0.096
1.5KE30A	1.5KE30CA	28.5	31.5	1.0	25.6	1.0	36.2	41.4	0.097
1.5KE33A	1.5KE33CA	31.4	34.7	1.0	28.2	1.0	32.8	45.7	0.098
1.5KE36A	1.5KE36CA	34.2	37.8	1.0	30.8	1.0	30.1	49.9	0.099
1.5KE39A	1.5KE39CA	37.1	41.0	1.0	33.3	1.0	27.8	53.9	0.100
1.5KE43A	1.5KE43CA	40.9	45.2	1.0	36.8	1.0	25.3	59.3	0.101
1.5KE47A	1.5KE47CA	44.7	49.4	1.0	40.2	1.0	23.1	64.8	0.101
1.5KE51A	1.5KE51CA	48.5	53.6	1.0	43.6	1.0	21.4	70.1	0.102
1.5KE56A	1.5KE56CA	53.2	58.8	1.0	47.8	1.0	19.5	77.0	0.103
1.5KE62A	1.5KE62CA	58.9	65.1	1.0	53.0	1.0	17.6	85.0	0.104
1.5KE68A	1.5KE68CA	64.6	71.4	1.0	58.1	1.0	16.3	92.0	0.104
1.5KE75A	1.5KE75CA	71.3	78.8	1.0	64.1	1.0	14.6	104	0.105
1.5KE82A	1.5KE82CA	77.9	86.1	1.0	70.1	1.0	13.3	113	0.105
1.5KE91A	1.5KE91CA	86.5	95.5	1.0	77.8	1.0	12.0	125	0.106
1.5KE100A	1.5KE100CA	95.0	105	1.0	85.5	1.0	10.9	137	0.106
1.5KE110A	1.5KE110CA	105	116	1.0	94.0	1.0	9.9	152	0.107
1.5KE120A	1.5KE120CA	114	126	1.0	102	1.0	9.1	165	0.107
1.5KE130A	1.5KE130CA	124	137	1.0	111	1.0	8.4	179	0.107
1.5KE150A	1.5KE150CA	143	158	1.0	128	1.0	7.2	207	0.106
1.5KE160A	1.5KE160CA	152	168	1.0	136	1.0	6.8	219	0.108
1.5KE170A	1.5KE170CA	162	179	1.0	145	1.0	6.4	234	0.108
1.5KE180A	1.5KE180CA	171	189	1.0	154	1.0	6.1	246	0.108

Device type		Breakdown voltage $V_{(BR)}$ (Volts) ⁽¹⁾		Test current at I_T (mA)	Stand-off voltage V_{WM} (Volts)	Maximum reverse leakage at V_{WM} I_D ⁽⁴⁾ (μA)	Maximum peak pulse current I_{PPM} ⁽²⁾ (A)	Maximum clamping voltage at I_{PPM} V_C (Volts)	Maximum temperature coefficient of V_{BR} (% / $^{\circ}C$)
		Min.	Max.						
1.5KE200A	1.5KE200CA	190	210	1.0	171	1.0	5.5	274	0.108
1.5KE220A	1.5KE220CA	209	231	1.0	185	1.0	4.6	328	0.108
1.5KE250A	1.5KE250CA	237	263	1.0	214	1.0	4.4	344	0.110
1.5KE300A	1.5KE300CA	285	315	1.0	256	1.0	3.6	414	0.110
1.5KE350A	1.5KE350CA	333	368	1.0	300	1.0	3.1	482	0.110
1.5KE400A	1.5KE400CA	380	420	1.0	342	1.0	2.7	548	0.110
1.5KE440A	1.5KE440CA	418	462	1.0	376	1.0	2.5	602	0.110
1.5KE480A	1.5KE480CA	456	504	1.0	408	1.0	2.3	658	0.110
1.5KE510A	1.5KE510CA	485	535	1.0	434	1.0	2.1	698	0.110
1.5KE530A	1.5KE530CA	503.5	556.5	1.0	450	1.0	2.1	725	0.110
1.5KE540A	1.5KE540CA	513	567	1.0	459	1.0	2.0	740	0.110
1.5KE550A	1.5KE550CA	522.5	577.5	1.0	467	1.0	2.0	760	0.110

- Notes: 1. $V_{(BR)}$ measured after I_T applied for 300 μs , I_T =square wave pulse or equivalent
 2. Surge current waveform per Fig. 3 and derate per Fig. 2
 3. For bidirectional types with V_R of 10 volts and less, the I_D limit is doubled
 4. All terms and symbols are consistent with ANSI/IEEE CA62.35
 5. For parts without A, the V_{BR} is $\pm 10\%$

Typical Characteristics ($T_{amb} = 25^{\circ}C$ unless otherwise specified)

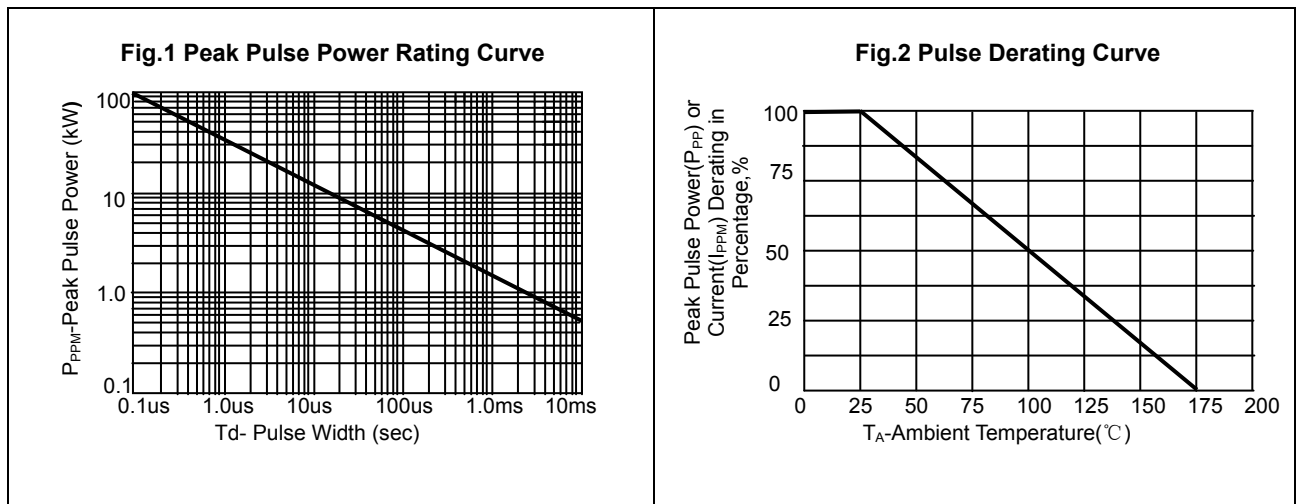

Fig.3 Pulse Waveform

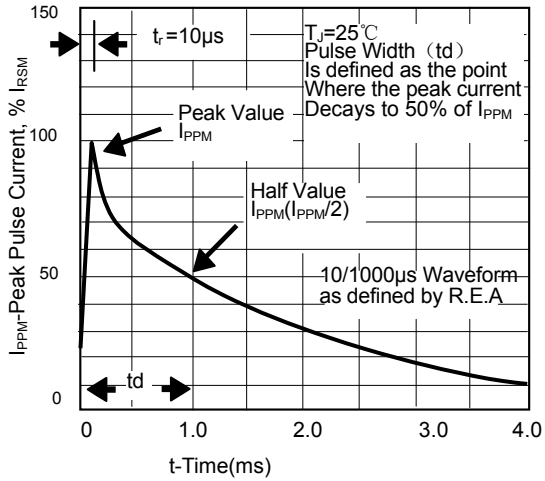

Fig.4 Typical Junction Capacitance

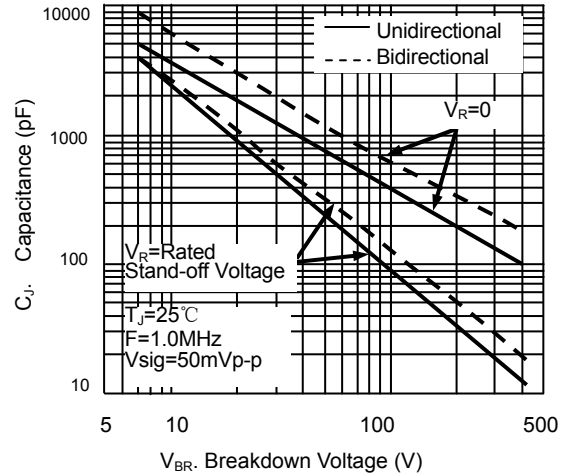

Fig.5 Steady State Power Derating Curve

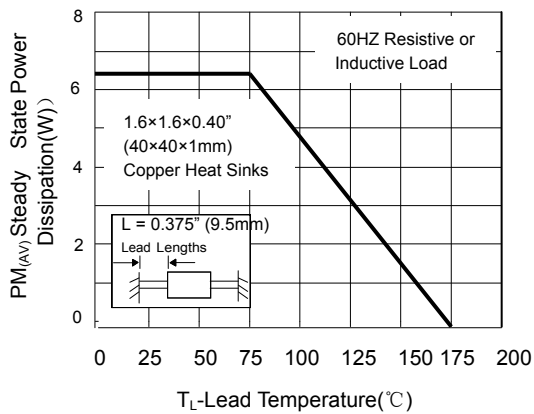

Fig.6 Max. Non-Repetitive Peak Forward Surge Current Unidirectional Only

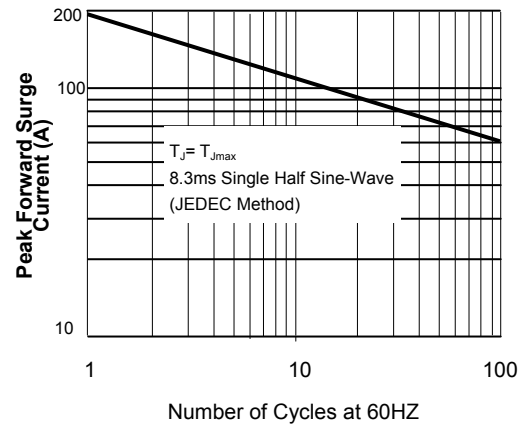

Fig.7 Incremental Clamping Voltage Curve (Unidirectional)

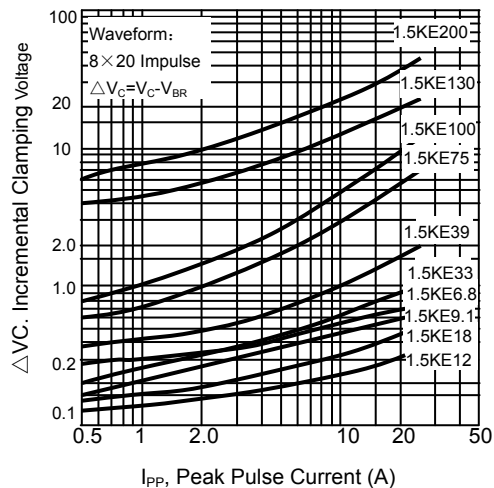

Fig.8 Incremental Clamping Voltage Curve (Bidirectional)

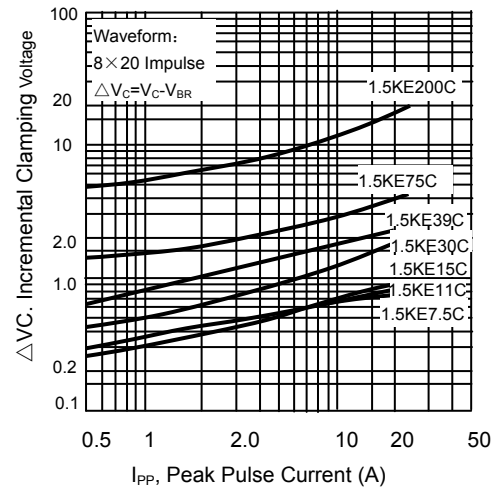

Fig.9 Instantaneous Forward Voltage Characteristics Curve

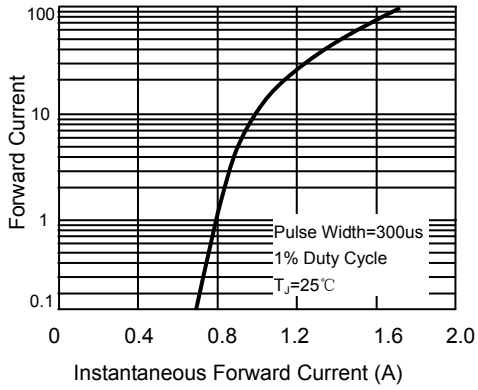

Fig.10 Breakdown Voltage Temperature Coefficient Curve

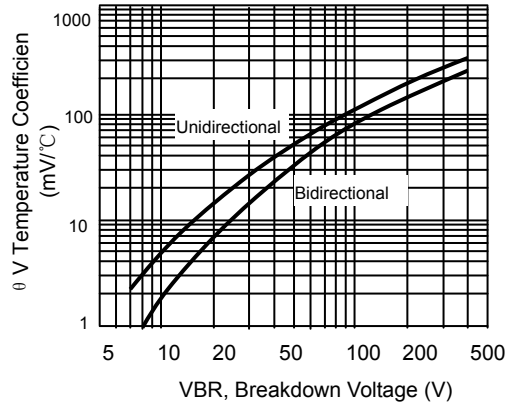
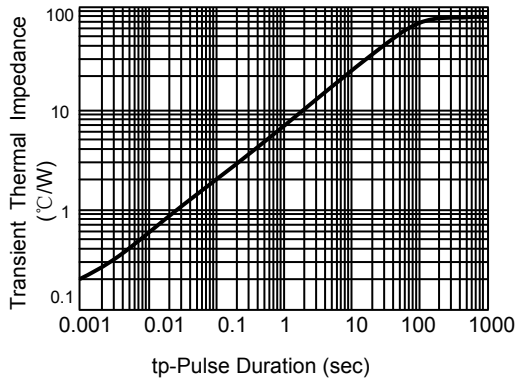
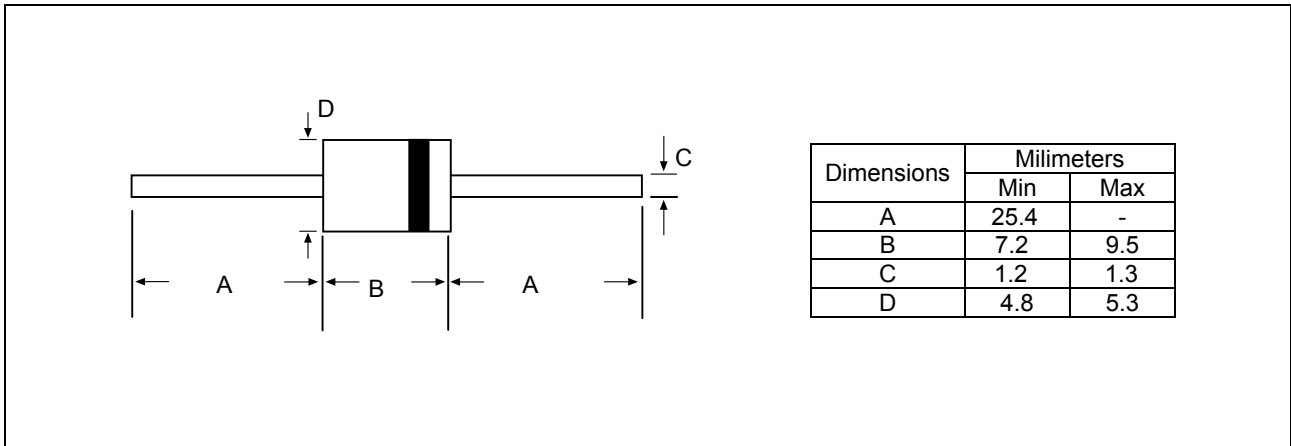

Fig.11 Typical Transient Thermal Impedance Thermal Impedance



Package Dimensions



Part number system

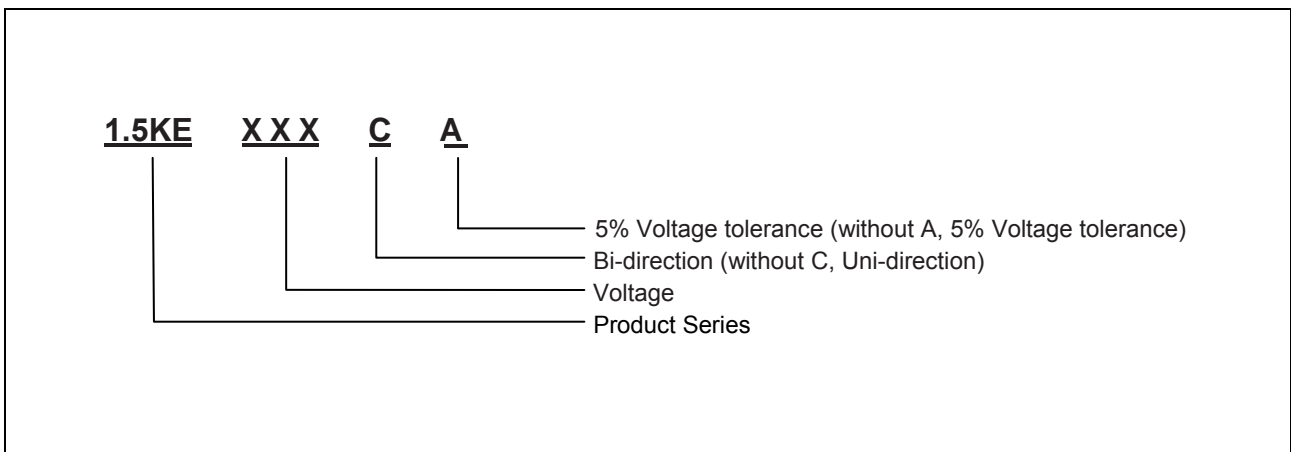

Ordering information

Order code	Package	Packaging option	Base quantity	Packaging specification
1.5KExxA(CA)	DO-201AD	Tape and BOX	1000pcs	EIA STD RS-481

Reision history

Date	Revision	Changes
23-May-2012	1.0	Initial release

CAUTION / WARNING

Information in this document is believed to be accurate and reliable. However, CREATEK does not give any representations or warranties, expressed or implied, as to the accuracy or completeness of such information and shall have no liability for the consequences of use of such information.

Users should independently evaluate the suitability of and test each product selected for their own applications, and CREATEK assumes no liability whatsoever relating to the choice, selection or use of the CREATEK products and services described herein.

CREATEK reserves the right to change or update, without notice, any information contained in this publication; to change, without notice, the design, construction, processing, or specification of any product; and to discontinue or limit production or distribution of any product.

Information in this document supersedes and replaces all information previously supplied.

Products are not designed, authorized or warranted to be suitable for use in medical, military, aircraft, space or life support equipment, nor in applications where failure or malfunction of an CREATEK product can reasonably be expected to result in personal injury, death or severe property or environmental damage. CREATEK accepts no liability for inclusion and/or use of CREATEK products in such equipment or applications and therefore such inclusion and/or use is at the customer's own risk.

This document as well as the item(s) described herein may be subject to export control regulations. Export might require a prior authorization from national authorities.

Resale of CREATEK products with provisions different from the statements and/or technical features set forth in this document shall immediately void any warranty granted by CREATEK for the CREATEK product or service described herein and shall not create or extend in any manner whatsoever, any liability of CREATEK.

CREATEK expressly disclaims all implied warranties regarding the information contained herein, including, but not limited to, any implied warranties of merchantability or fitness for a particular purpose. CREATEK only obligations are those in the CREATEK Standard Terms and Conditions of Sale and in no case will CREATEK be liable for any incidental, indirect, or consequential damages arising from the sale, resale, use, or misuse of its products.

Specifications are subject to change without notice

© Copyright 2009, CREATEK Microelectronics

 CREATEK® is a registered trademark of CREATEK Microelectronics

All rights reserved