

为提高组合部件设计的自由度做出了贡献的本体高度7.5mm的薄型



检测

滑动

按动

旋转

电源

切换式

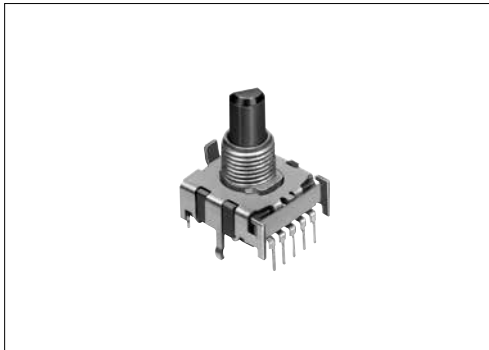

■主要规格

项目		规格
最大额定/最小额定(电阻负载)		0.3A 16V DC / 50 μ A 3V DC
接触电阻(初期/寿命后)		50m Ω max. / 150m Ω max.
旋转扭矩		30 \pm 15mN.m
操作寿命	无负载	10,000 cycles
	负载	10,000 cycles (0.3A 16V DC)

■产品一览

电路数	接点数	切换角度	切换时限	操作部形状	操作部长度 (mm)	最小订货单位 (pcs.)		产品编号
						日本	出口	
1	3	30 \pm 3°	Non shorting	Flat	L=15	165	330	SRBV131803
					L=20			SRBV131502
	4				L=15			SRBV141404
					L=20			SRBV141201
	5				L=15			SRBV151102
					L=20			SRBV150901
	6				L=15			SRBV160803
								SRBV170701
	7				L=20			SRBV170501
								L=15

■包装规格

托盘

包装数 (pcs.)		出口包装箱尺寸 (mm)
1箱/日本	1箱/出口包装	
165	330	400 \times 270 \times 185

外形图

Unit:mm

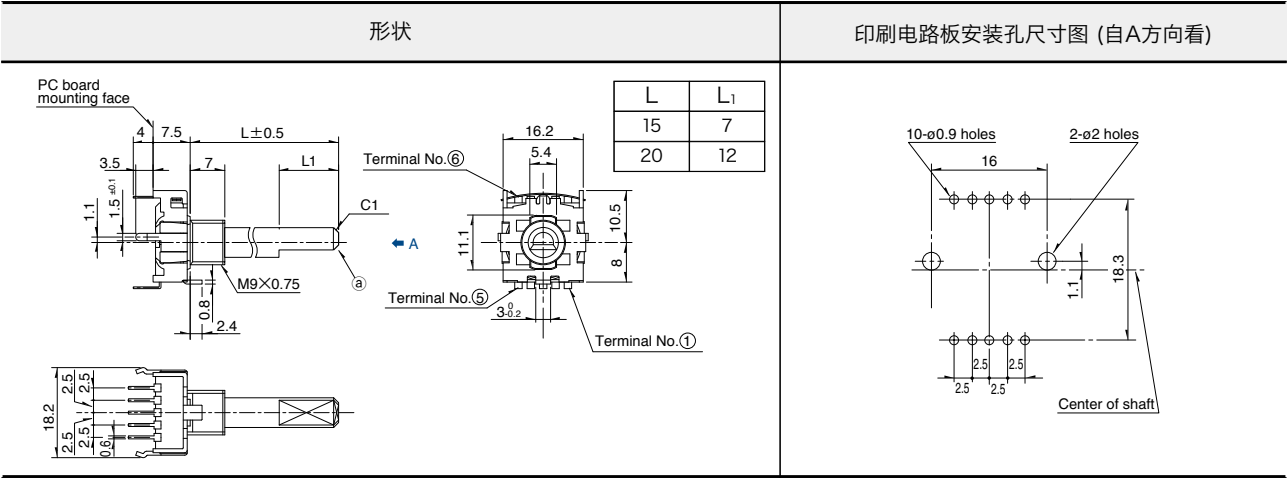

操作部详图(a)

Unit:mm

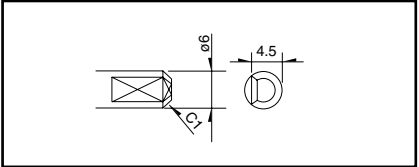

标准电路图 (自A方向看)

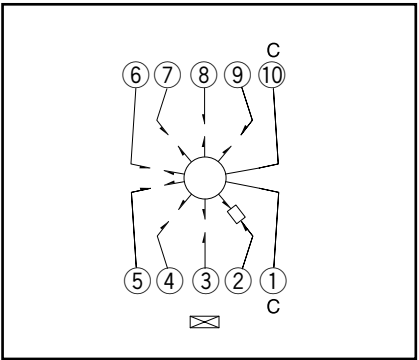

虚拟端子

3-position	⑤ ⑥ ⑦ ⑧ ⑨
4-position	⑥ ⑦ ⑧ ⑨
5-position	⑦ ⑧ ⑨
6-position	⑧ ⑨
7-position	⑨
8-position	—

附属零部件



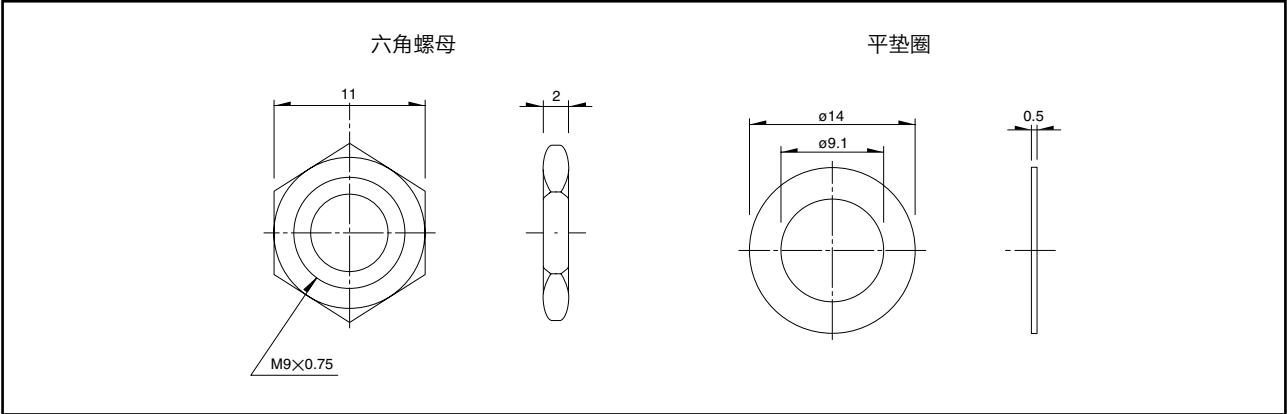





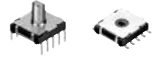

Unit:mm



检测
滑动
按动
旋转
电源
切换式

旋转开关

产品系列一览

系列		SRBD	SRBQ		SRBM		SRBV	SRRM	SRRN																																						
			Insertion	Reflow type	Rotary	Pulse																																									
照片																																															
切换角度		36°	40±3°		30±3°	18±3°	30±3°																																								
电路数		1		1, 2		1	1, 2, 3, 4	2, 3, 4																																							
旋转扭矩		13±5mN·m	6±3mN·m 13±5mN·m		40±20mN·m 15±7mN·m		30±15mN·m	80±30mN·m (Shoting) 70±30mN·m (Non shorting)	70±30mN·m																																						
外形尺寸 (mm)		W	10		10		16.2	—	—																																						
		D	11.4		12.5		18.5																																								
		H	12.4		11		7.5																																								
使用温度范围		-25°C to +85°C	-10°C to +60°C		-30°C to +85°C		-10°C to +85°C	-10°C to +60°C	-30°C to +65°C																																						
车用产品		—	—		—		—	—	—																																						
生命周期																																															
最大额定 最小额定 (电阻负载)		1mA 5V DC 50μA 3V DC	0.1A 16V DC 50μA 3V DC		0.3A 16V DC 50μA 3V DC		0.25A 30V DC 50μA 3V DC	0.15A 12V DC 50μA 3V DC																																							
耐久性	无负载寿命	10,000 cycles 250mΩ max.	10,000 cycles 100mΩ max.		30,000 cycles 100mΩ max.	10,000 cycles 100mΩ max.		10,000 cycles 40mΩ max.	10,000 cycles 70mΩ max.																																						
	负载寿命 最大额定负载	10,000 cycles 250mΩ max.	10,000 cycles 100mΩ max.		10,000 cycles 150mΩ max.		10,000 cycles 60mΩ max.	10,000 cycles 100mΩ max.																																							
电性能	接触电阻	200mΩ max.	50mΩ max.				20mΩ max.	50mΩ max.																																							
	绝缘电阻	100MΩ min. 100V DC					100MΩ min. 500V DC																																								
	耐电压	100V AC for 1minute					500V AC for 1minute																																								
机械性能	端子强度	3N for 1minute	5N for 1minute				10N for 1minute	5N for 1minute																																							
	操作部 强度	旋转 方向	—	—	0.5N·m	—	0.6N·m	1N·m																																							
		推进 方向	50N	20N		100N																																									
操作部的 摆动		轴尖端的负载 SRRM, SRBM, SRRN: 5N、SRBQ, SRBV: 1N SRRM, SRBM, SRRN 如下表所示 <table border="1" data-bbox="422 1512 742 1736"> <thead> <tr> <th>自安装面的 测量位置</th> <th>轴的振动幅度 (最大值)</th> <th>适用安 装尺寸</th> </tr> </thead> <tbody> <tr><td>10</td><td>0.17</td><td>15</td></tr> <tr><td>15</td><td>0.25</td><td>20</td></tr> <tr><td>20</td><td>0.35</td><td>25</td></tr> <tr><td>25</td><td>0.42</td><td>30</td></tr> <tr><td>30</td><td>0.5</td><td>above 35</td></tr> </tbody> </table> SRBQ 如下表所示 <table border="1" data-bbox="774 1512 1029 1668"> <thead> <tr> <th>自安装面的 轴尖端高度</th> <th>轴的振动幅度 (最大值)</th> </tr> </thead> <tbody> <tr><td>below 5</td><td>0.5</td></tr> <tr><td>above 5 and below 10</td><td>0.9</td></tr> <tr><td>above 10 and below 15</td><td>1.2</td></tr> </tbody> </table> SRBV 如下表所示 <table border="1" data-bbox="1061 1512 1380 1668"> <thead> <tr> <th>自安装面的 测量位置</th> <th>轴的振动幅度 (最大值)</th> <th>适用安 装尺寸</th> </tr> </thead> <tbody> <tr><td>10</td><td>0.2</td><td>15</td></tr> <tr><td>15</td><td>0.3</td><td>20</td></tr> <tr><td>20</td><td>0.4</td><td>25</td></tr> </tbody> </table> Unit:mm								自安装面的 测量位置	轴的振动幅度 (最大值)	适用安 装尺寸	10	0.17	15	15	0.25	20	20	0.35	25	25	0.42	30	30	0.5	above 35	自安装面的 轴尖端高度	轴的振动幅度 (最大值)	below 5	0.5	above 5 and below 10	0.9	above 10 and below 15	1.2	自安装面的 测量位置	轴的振动幅度 (最大值)	适用安 装尺寸	10	0.2	15	15	0.3	20	20	0.4	25
自安装面的 测量位置	轴的振动幅度 (最大值)	适用安 装尺寸																																													
10	0.17	15																																													
15	0.25	20																																													
20	0.35	25																																													
25	0.42	30																																													
30	0.5	above 35																																													
自安装面的 轴尖端高度	轴的振动幅度 (最大值)																																														
below 5	0.5																																														
above 5 and below 10	0.9																																														
above 10 and below 15	1.2																																														
自安装面的 测量位置	轴的振动幅度 (最大值)	适用安 装尺寸																																													
10	0.2	15																																													
15	0.3	20																																													
20	0.4	25																																													
耐环境 性能	耐寒性能	-40°C 500h	-20°C 96h	-40°C 96h	-20°C 96h		-40°C 96h																																								
	耐热性能	85°C 500h	85°C 96h																																												
	耐湿性能	60°C, 90 to 95%RH 500h	40°C, 90 to 95%RH 96h																																												
页		133	135	137	140	142	145																																								

旋转开关焊接条件 148
 旋转开关使用时的注意事项 149

回流方式的参考举例

1. 加热方式 以远红外线加热的上下加热方式。
2. 温度测量方式用 $\phi 0.1\sim\phi 0.2$ 的 CA (K) 或 CC (T) 测量。位置在焊接连接部 (铜箔面) 测量。固定方式采用耐热胶带。
3. 温度分布

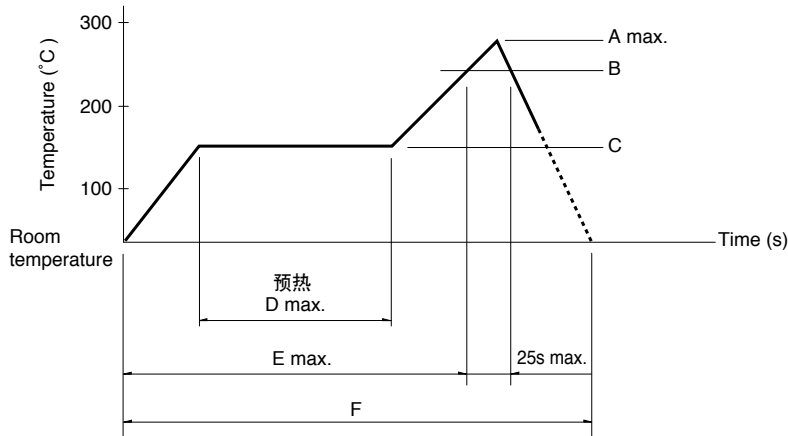

系列 (回流型)	A (°C) 3s max.	B (°C)	C (°C)	D (s)	E (s)	F (s)
SRBQ	250	200	150±5	80 to 100	—	—

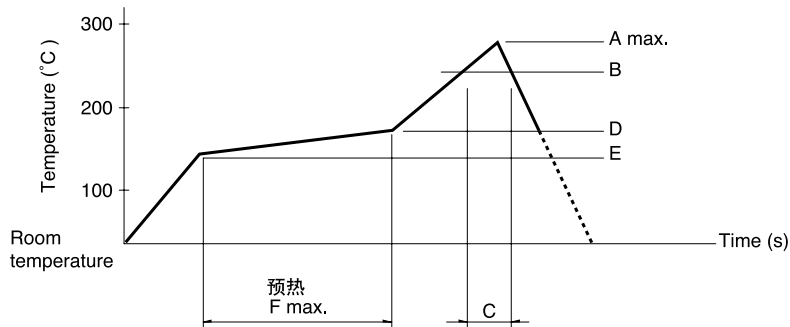

系列 (回流型)	A (°C) 3s max.	B (°C)	C (s)	D (°C)	E (°C)	F (s)
SRBD	260	230	40	180	150	120

- 注**
1. 上述条件, 为印刷电路板的零部件贴装面上的温度, 根据电路板的材质, 大小, 厚度等, 电路板温度和开关表面温度会有很大的不同, 关于开关表面温度, 也请在上述条件内使用。
 2. 根据回流槽的种类, 条件稍有不同, 请事先充分进行确认之后使用。

手工焊接方式的参考举例

系列	焊接温度	焊接时间
SRBQ, SRBM, SRBV, SRRM, SRRN	350±10°C	3+1 / 0s
SRBQ (回流型)	350±5°C	3s max.

浸焊方式的参考举例

适用于 For PC board 端子型

系列	项目		浸焊	
	预热温度	预热温度时间	焊接温度	焊接浸渍时间
SRBM	100°C max.	60s max.	260±5°C	5s max.
SRBV, SRRM, SRRN	—	—	260±5°C	10±1s
SRBQ	—	—	260±5°C	5±1s