

SPECIFICATION FOR APPROVAL

CUSTOMER : _____

PRODUCT TYPE : SMD SEAM SEALING X'TAL 2.5 × 2.0

NOMINAL FREQ. : 50.000000MHz

TXC P/N : 8Z50000002

REVISION : A2

CUSTOMER P/N : _____

PM / SALES : _____

DATE : _____

CUSTOMER SIGNATURE & Date _____

- (1) TXC requires one copy returned with signature and title of authorized individual that signifies acceptance of the attached specifications.
- (2) Orders received and accepted by TXC after return of signed copy of specification will be produced per these specifications.
- (3) Any changes to these specifications must be agreed upon by both parties and new revision of the Product Specification Sheet will be issued.
- (4) Any issuance of purchase order prior to consigning back the Approval page of "Specification Sheets" from customers will be regarded as the agreement on the contents of these specifications.

Attachment: Product Specification Sheet

- 1
- 2
- 3
- 4
- 5

RoHS Compliant



PRODUCT SPECIFICATION SHEET

PRODUCT TYPE : SMD SEAM SEALING X'TAL 2.5 × 2.0

NOMINAL FREQ. : 50.000000MHz

TXC P/N : 8Z50000002

REVISION : A2

PE/RD	QA	MFG
<i>Robin Huang</i> Robin Huang	<i>Samson Xiong</i> Samson Xiong	<i>Jake Liu</i> Jake Liu
<i>4-Aug-14</i>	<i>4-Aug-14</i>	<i>4-Aug-14</i>

NOTE:

- (1)Lead Free Products are "Directive 2002/95/EC of The European Parliament of 27 January 2003 on the restriction of the use of certain hazardous substances (RoHS) in electrical and electronic equipment" Compliant (Attachment: SGS Test Report).
- (2)Revision "Sx" is for engineering samples only. PE/RD's approval required.
- (3)Revision "Ax" is production ready. PE, QA and MFG's approval required

RoHS Compliant

Spec Sheet Contents

No.	Content	Page
1	ELECTRICAL SPECIFICATIONS	P.3
2	FACTORY LOCATION	P.3
3	DIMENSIONS	P.4
4	MARKING	P.4
5	SUGGESTED REFLOW PROFILE& MANUAL SOLDER CONDITION	P.4
6	STRUCTURE ILLUSTRATION	P.5
7	EMBOSS CARRIER TAPE & REEL	P.6
8	PACKING	P.7
9	RELIABILITY SPECIFICATIONS&HANDING CAUTIONS	P.8~9

■ ELECTRICAL SPECIFICATIONS

Standard atmospheric conditions

Unless otherwise specified, the standard range of atmospheric conditions for making measurement and tests are as follow:

Ambient temperature : $25 \pm 10^{\circ}\text{C}$
 Relative humidity : 40%~70%

If there is any doubt about the results, measurement shall be made within the following limits:

Ambient temperature : $25 \pm 3^{\circ}\text{C}$
 Relative humidity : 40%~70%

Measure equipment

Electrical characteristics measured by S&A250B or equivalent.

Crystal cutting type

The crystal is using AT CUT (thickness shear mode).

Unit Weight:

0.009±0.001 g/pcs

	Parameters	Symbol	Electrical Spec.				Notes
			Min.	Typ.	Max.	Units	
1	Nominal Frequency	FL	50.000000			MHz	-
2	Oscillation Mode	-	Fundamental			-	-
3	Load Capacitance	CL	16			pF	-
4	Frequency Tolerance	-	±15			ppm	at 25 °C ± 3 °C
5	Frequency Stability	-	±15			ppm	Over Operating Temp. Range (Reference 25°C)
6	Operating Temperature	-	-40	~	85	°C	-
7	Aging	-	±2			ppm	1st Year
8	Drive Level	DL	-	100	300	uW	-
9	Equivalent Series Resistance	Rr	-	-	50	Ω	-
10	Shunt Capacitance C0	C0	-	-	3	pF	-
11	Insulation Resistance	-	500	-	-	MΩ	at DC 100V
12	Storage Temperature Range	-	-55	~	125	°C	-

■ FACTORY LOCATION

TXC (NINGBO) CORPORATION
 NO.189 Huang Shan West Road, Beilun District,
 Ningbo Zhejiang China

■ DIMENSIONS

(Unit:mm)

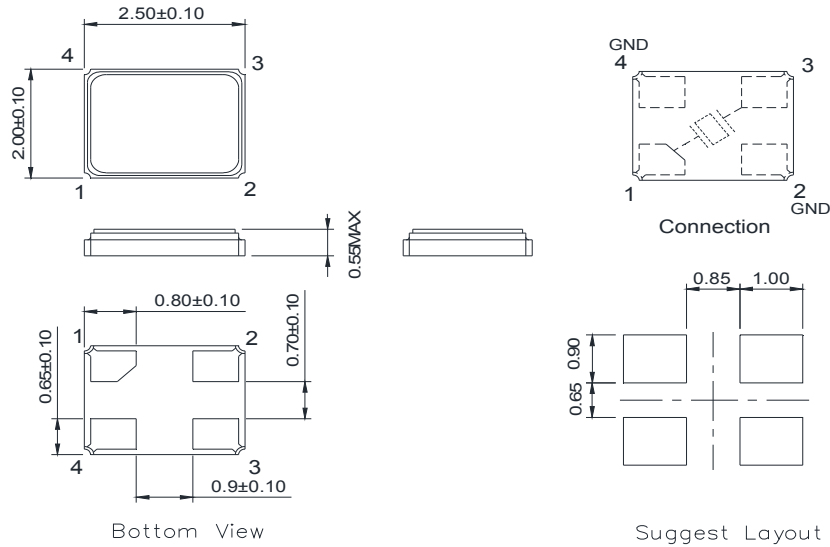

■ MARKING

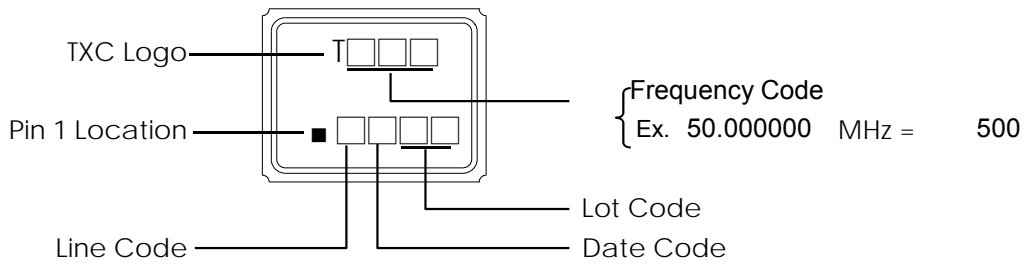

Date Code:

YEAR		MONTH				JAN	FEB	MAR	APR	MAY	JUN	JUL	AUG	SEP	OCT	NOV	DEC
2005	2009	2013	2017	A	B	C	D	E	F	G	H	J	K	L	M		
2006	2010	2014	2018	N	P	Q	R	S	T	U	V	W	X	Y	Z		
2007	2011	2015	2019	a	b	c	d	e	f	g	h	j	k	l	m		
2008	2012	2016	2020	n	p	q	r	s	t	u	v	w	x	y	z		

*This date code will be cycled every four years

Production location: Taiwan&Ningbo

■ SUGGESTED REFLOW PROFILE

Total time : 200 sec. Max.

Solder melting point :220 °C

■ SUGGESTED MANUAL SOLDER CONDITION

Temperature: 350 ± 10 °C

Time: 3 sec.

Re-solder times: twice

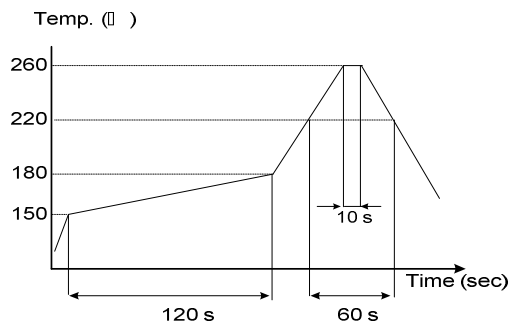

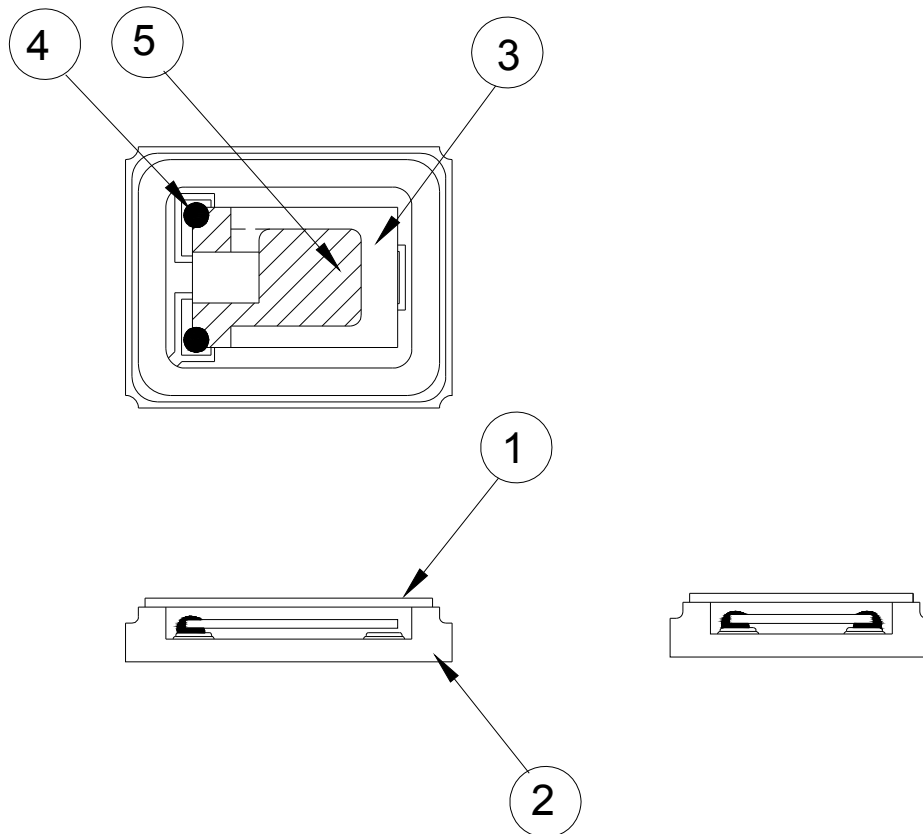
■ STRUCTURE ILLUSTRATION

NO	COMPONENTS	MATERIALS	FINISH/SPECIFICATIONS
1	Lid	Kovar (Fe/Co/Ni)	-
2	Base(Package)	Ceramic (Al ₂ O ₃) + Kovar (Fe/Co/Ni)+Pad(Au)	Tungsten metalize + Ni plating + Au plating
3	Crystal blank	SiO ₂	-
4	Conductive adhesive	Resin+Ag	-
5	Electrode	Noble Metal	-

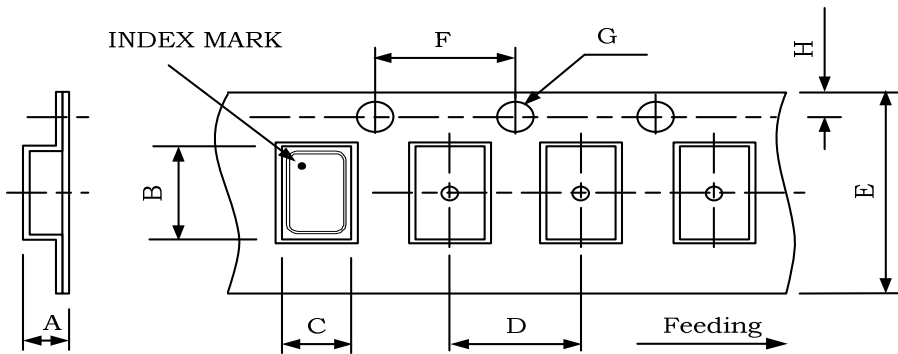
PACKING

DIMENSIONS	A	B	C	D	E	F	G	H	(UNIT : mm)
	1.05	2.70	2.25	4.00	8.00	4.00	1.55	1.75	

REMARK :

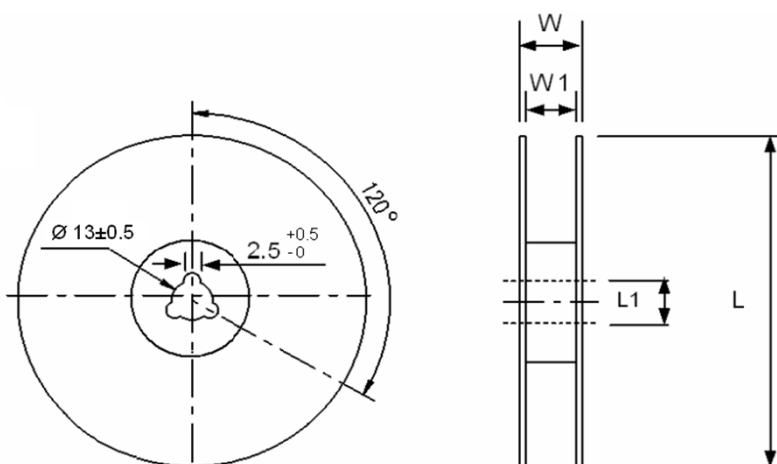
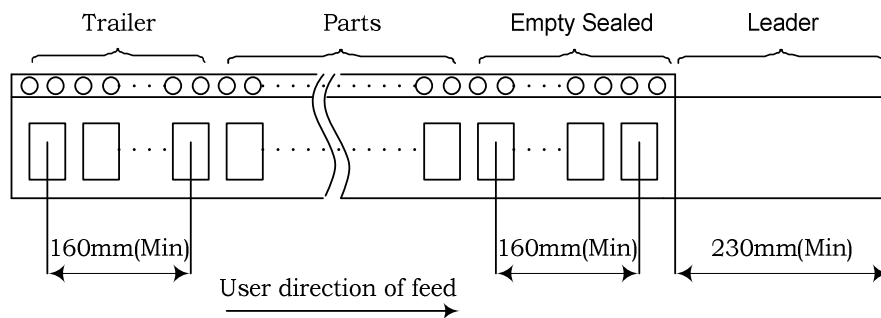

DIMENSIONS	L	L1	W	W1	pcs / Reel (UNIT : mm)
	178	13	11.5	8	Standard Reel Quantity is 3,000 pcs per reel

PACKING

Reel Quantity :

- 1. Reel X 6 (6 Reels)
- 2. Reel X 12 (12 Reels)
- 3. Reel X 25 (12 Reels + 13 Reels)
- 4. Reel X 50 (12 Reelsx2 + 13 Reelsx2)

Box Size:

- 1. L200 X W200 X H140mm
- 2. L200 X W200 X H250mm
- 3. L400 X W200 X H250mm
- 4. L400 X W400 X H280mm

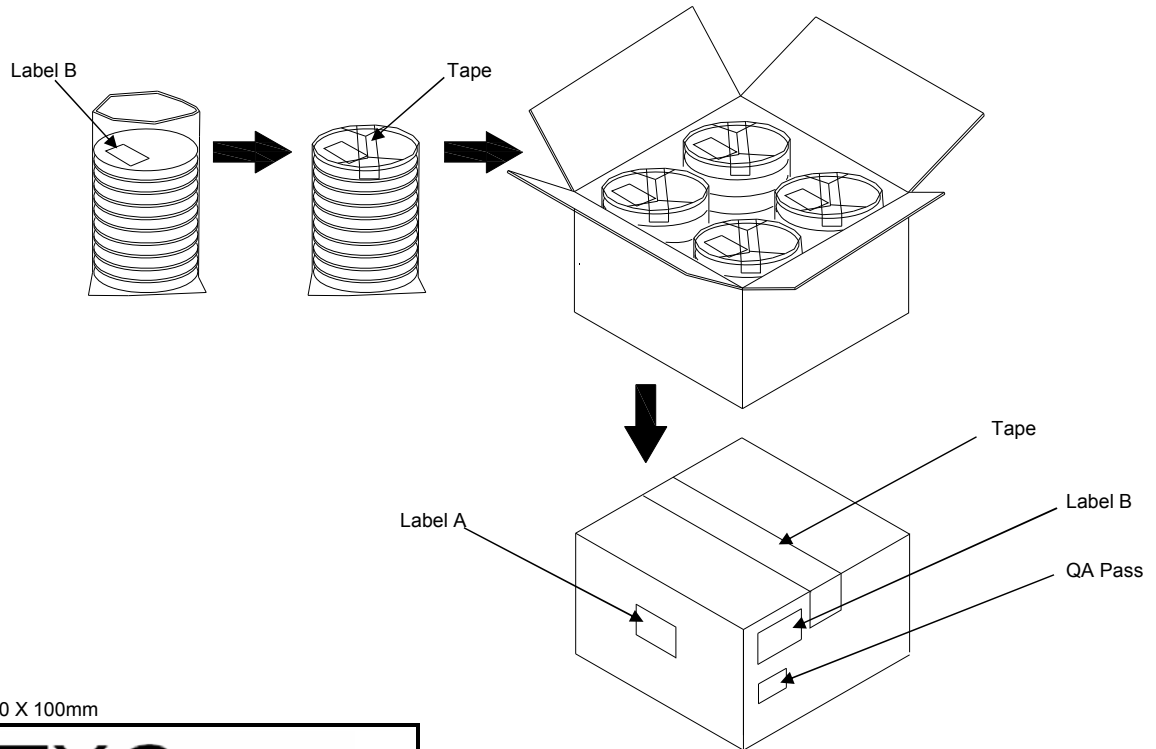

(Label A) Size:100 X 100mm

<h1 style="margin: 0;">TXC</h1>	
Inv No:	□□□□□□□□
Po No:	□□□□□□□□
Part No:	□□□□□□□□
Qty:	□□□□ PCS
C/No:	□□□□

(Label B) Size:80 X 40mm

TXC CORPORATION		QA PASS
DATE CODE:		QTY:
LOT NO:		
PART NO:		
FREQ:	□□□□□□□□	

[STORAGE]

- 1.The storage time to be 1 year maximum.
- 2.Don't be caught in the rain.
- 3.The storage environment shall be 5°C ~40°C temperature and 30% ~ 75%RH humidity and free from the sun shine.
- 4.If customers have special requirements, we can paste labels according to it.

■ RELIABILITY SPECIFICATIONS

1. Mechanical Endurance

No.	Test Item	Test Methods	Test Criteria
1	Drop Test	150 cm height, 3 times on concrete floor.	A . C
1	Mechanical Shock	Device are shocked to half sine wave (1000 G) three mutually perpendicular axes each 3 times. 0.5m sec. duration time	A . C
1	Vibration	Frequency range 10 ~ 2000 Hz Amplitude 1.52 mm/20G Sweep time 20 minutes perpendicular axes each test time 4 Hrs (Total test time 12 Hrs)	A . C
1	Solder ability	Temperature 240 °C ± 5°C Immersing depth 0.5 mm minimum Immersion time 5 ± 1 seconds Flux Rosin resin methyl alcohol solvent (1 : 4)	E

2. Environmental Endurance

No.	Test Item	Test Methods	Test Criteria
2	Resistance To Soldering Heat	Pre-heat temperature 125 °C Pre-heat time 60 ~ 120 sec. Test temperature 260 ± 5 °C Test time 10 ± 1 sec.	B . C . D
2	High Temp. Storage	+ 125 °C ± 3 °C for 500 ± 12 Hrs	B . C . D
2	Low Temp. Storage	- 40 °C ± 3 °C for 500 ± 12 Hrs	
2	Temperature cycle	Total 100 cycles of the following temperature cycle 	B . C . D
3	High Temp & Humidity	85°C ± 3°C, RH 85% , 500Hrs	B . C . D

RELIABILITY SPECIFICATIONS

Specifications	
A	Frequency change: Within ± 5 ppm or in customer's specification.
B	Frequency change: Within ± 10 ppm or in customer's specification.
C	Equivalent series resistance(E.S.R) change: Within $\pm 15\%$ or 10Ω (larger value).
D	After conditioning , quartz crystal units shall be subjected to standard atmospheric conditions for 2 hour, and measured.
E	Minimum 95% of immersed terminal shall be covered with new uniform solder.

Measurement condition

Electrical characteristics measured by S&A250B or equivalent.