

Green-Mode PWM Controller with Integrated Protections

Features

- Current mode control
- Very low startup current
- Under-voltage lockout (UVLO)
- Non-audible-noise green-mode control
- Programmable switching frequency
- Cycle-by-cycle peak current limiting
- Internal leading-edge blanking
- Internal slope compensation
- Internal soft start
- Gate output voltage clamp
- Over-voltage protection (OVP) on VCC pin
- Over-load protection (OLP)
- Over-current protection (OCP) on CS pin
- Over-temperature protection (OTP) on chip
- 300mA driving capability

Description

The GR8836 is a highly-integrated, low startup current, current mode PWM controller with green-mode function. This function enables the power supply to easily meet even the strictest power conservation requirements. The integrated functions also include the leading-edge blanking of the current sensing, internal slope compensation, cycle-by-cycle peak current limiting, and soft start. OLP, OCP and OVP provide protection performance for fault conditions. To protect the external power MOSFET from being damaged by supply over voltage, the GR8836 OUT pin voltage is clamped to about 18V. The GR8836 improves the performance and reduces the cost of power supplies. It is with 8-pin DIP and 6-pin SOT-26 package.

Applications

- Switching AC/DC power adapter
- Battery charger
- Open-frame SMPS

Ordering and Marking Information

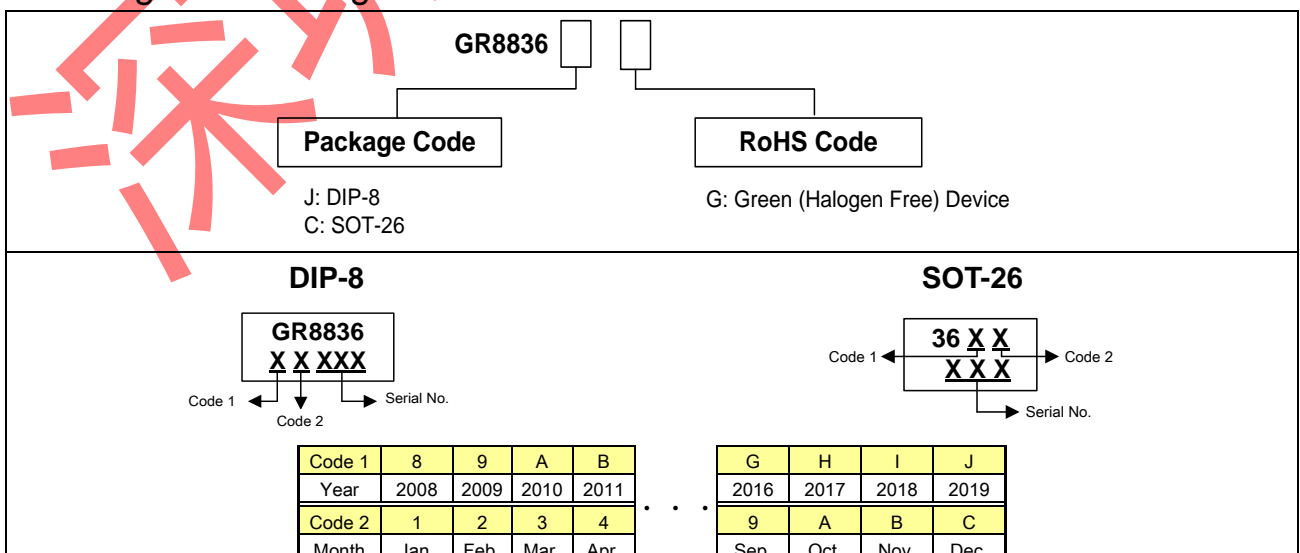

Greenergy OPTO Inc. reserves the right to make changes to improve reliability or manufacture ability without notice, and advise customers to obtain the latest version of relevant information to verify before placing orders.

Pin Configuration

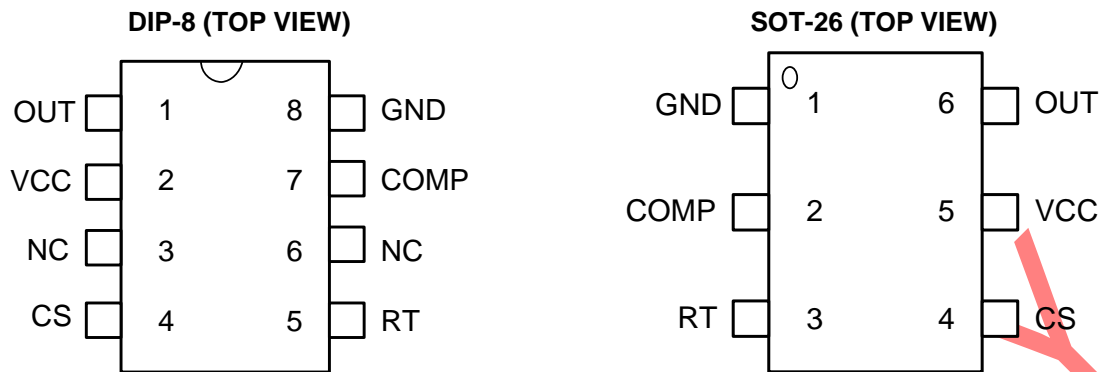

Pin Description

Pin No.	Name	Function
1	GND	Ground
2	COMP	Voltage feedback pin, by connecting a photo-coupler to control the duty cycle
3	RT	Connecting a resistor to ground, this resistor determine the switching frequency
4	CS	Current sense pin, connect to sense the MOSFET current
5	VCC	Power supply pin
6	OUT	The output driver for driving the external MOSFET

Note: Pin No. is only for SOT-26 package.

Absolute Maximum Ratings

Supply voltage VCC	30V
COMP, RT, CS	-0.3 ~ 7V
OUT	-0.3 ~ VCC + 0.3V
Junction temperature	150°C
Operating ambient temperature	-20°C ~ 85°C
Storage temperature range	-65°C ~ 150 °C
SOT-26 package thermal resistance	250°C/W
Power dissipation (SOT-26, at ambient temperature = 85°C)	250mW
Power dissipation (DIP-8, at ambient temperature = 85°C)	650mW
Lead temperature (All Pb free packages, soldering, 10 sec)	260°C
ESD voltage protection, human body model	3KV
ESD voltage protection, machine model	200V

Recommended Operating Conditions

Item	Min.	Max.	Unit
Supply voltage VCC	12	25	V
Switching frequency	50	130	KHz

Block Diagram

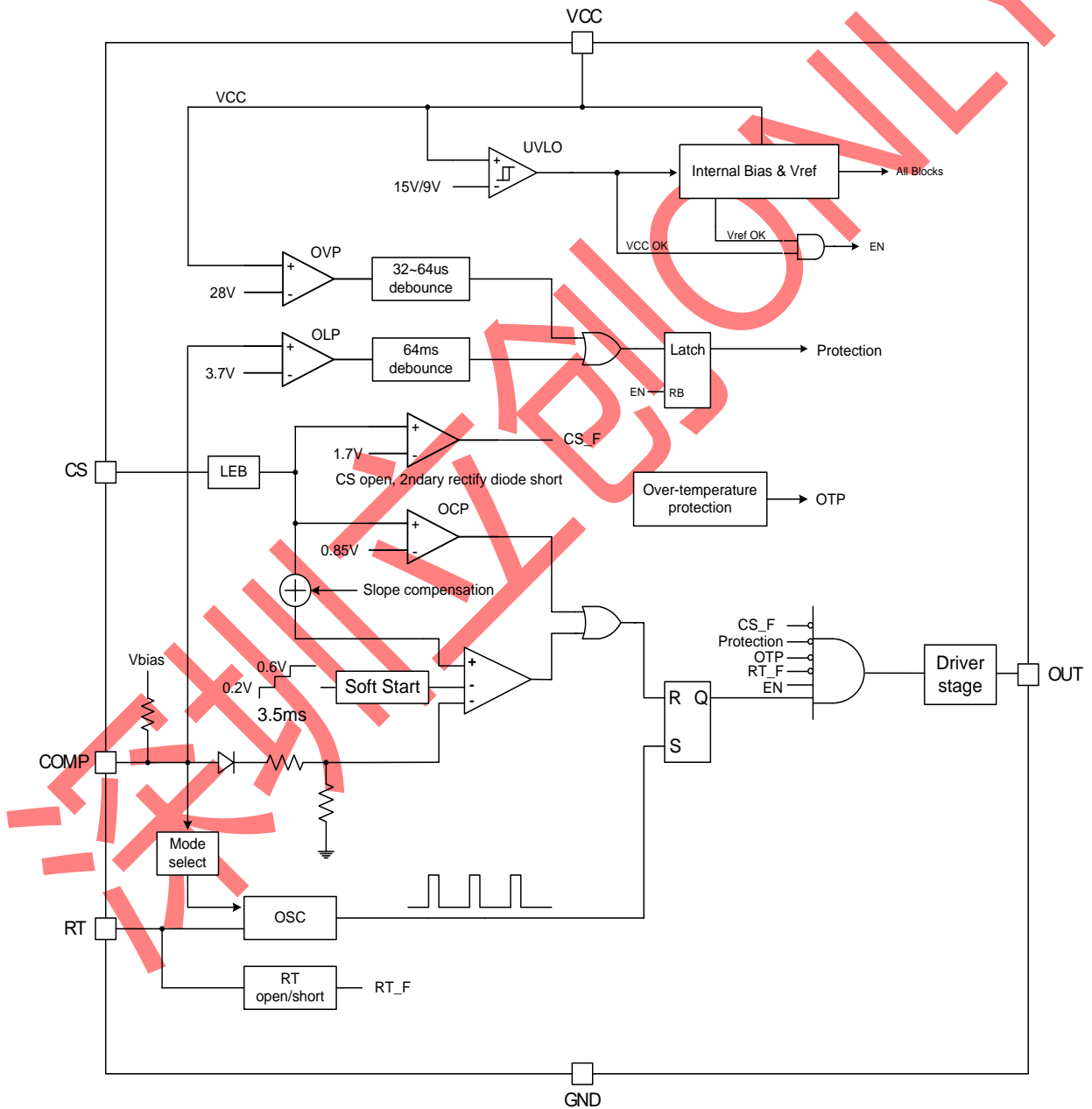

Electrical Characteristics ($T_A = +25^{\circ}\text{C}$ unless otherwise stated, $V_{CC} = 15.0\text{V}$)

Parameter	Pin	Min.	Typ.	Max.	Unit
-----------	-----	------	------	------	------

SUPPLY VOLTAGE

Startup current	5		8	20	μA
Operating current (with 1nF load on OUT pin), $V_{\text{comp}} = 0\text{V}$	5		2.0		mA
Operating current (with 1nF load on OUT pin), $V_{\text{comp}} = 2.5\text{V}$	5		2.5		mA
Operating current (with 1nF load on OUT pin), protection tripped (OLP, OVP)	5		0.5		mA
UVLO(off)	5	8.0	9.0	10.0	V
UVLO(on)	5	13.3	15.0	17	V
OVP level on VCC pin	5	26.5	28	29.5	V

VOLTAGE FEEDBACK

Short circuit current, $V_{\text{comp}} = 0\text{V}$	2		1		mA
Open loop voltage, COMP pin open	2		4.5		V
Green-mode threshold voltage	2		1.8		V

CURRENT SENSING

Maximum input voltage, V_{cs} (off)	4	0.85	0.90	0.95	V
Leading-edge blanking time	4		350		nS
Input impedance	4	1			M Ω
Delay to Output	4		100		nS

OSCILLATOR

Frequency ($R_T = 100\text{K}\Omega$)	3	60	65	70	KHz
Jitter frequency	3		± 3		%
Green mode frequency ($R_T = 100\text{K}\Omega$)	3	18	22	30	KHz
Temp. stability ($-40^{\circ}\text{C} \sim 110^{\circ}\text{C}$)	3			3	%
Voltage stability ($V_{CC} = 11\text{V} \sim 25\text{V}$)	3			1	%

GATE DRIVER OUTPUT

Output low level, $V_{CC} = 15\text{V}$, $I_o = 20\text{mA}$	6			1	V
Output high level, $V_{CC} = 15\text{V}$, $I_o = 20\text{mA}$	6	8			V
Rising time, load capacitance = 1000pF	6		250		nS
Falling time, load capacitance = 1000pF	6		70		nS
VGATE-clamp ($V_{CC} = 25\text{V}$)	6		18		V

OLP

OLP trip level, V_{comp} (OLP)	-		3.7		V
OLP delay time, $F_s = 65\text{KHz}$	-		60		mS

PWM SECTION

Maximum duty cycle	-	70	75	80	%
Soft start time, $F_s = 65\text{KHz}$	-		3.5		mS



OTP

OTP trip level	-		160		°C
OTP recovery level	-		135		°C

Note: Pin No. is only for SOT-26 package.

深圳立包ONLY

Typical Performance Characteristics

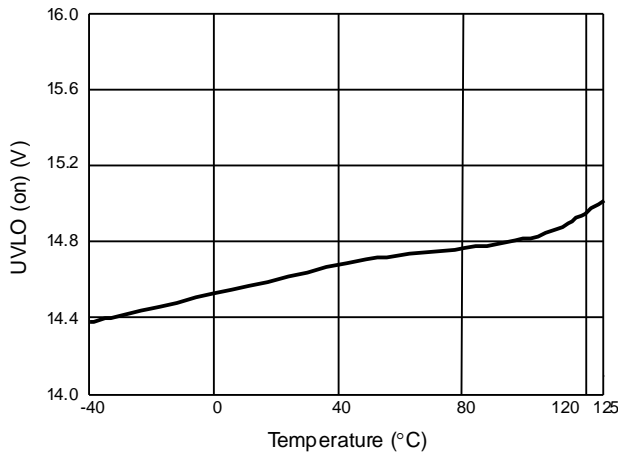

Fig. 1 UVLO (on) vs. Temperature

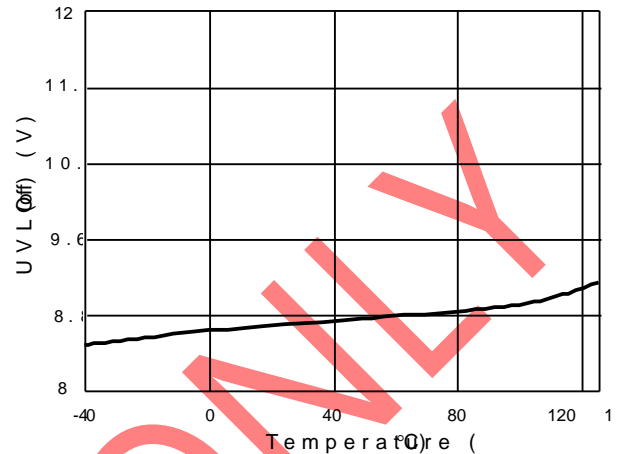

Fig. 2 UVLO (off) vs. Temperature

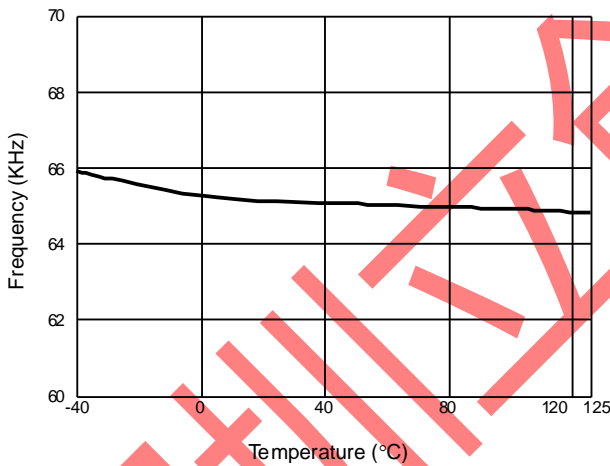

Fig. 3 Frequency vs. Temperature

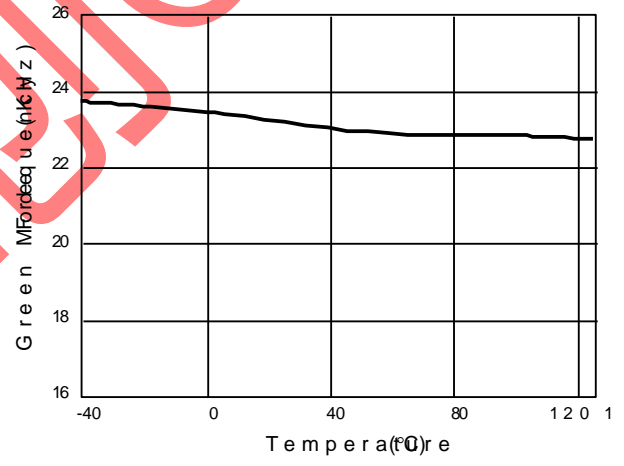

Fig. 4 Green Mode Frequency vs. Temperature

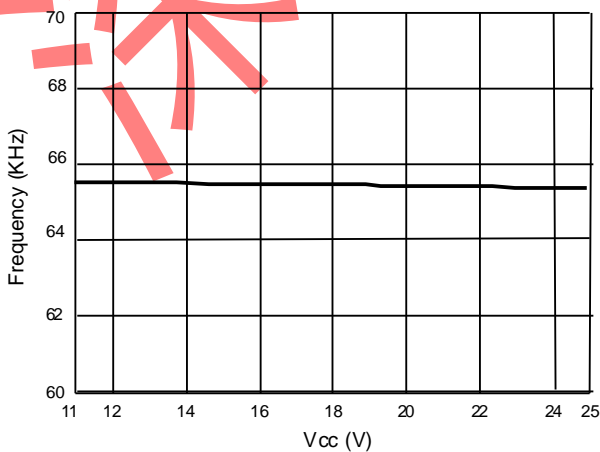

Fig. 5 Frequency vs. Vcc

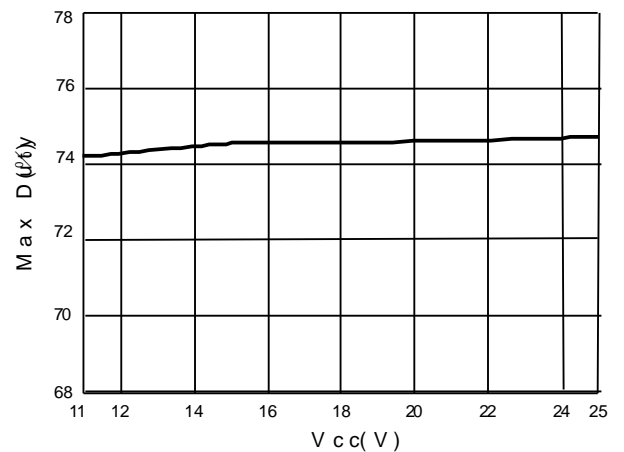

Fig. 6 Max D vs. Vcc

Typical Performance Characteristics (Cont.)

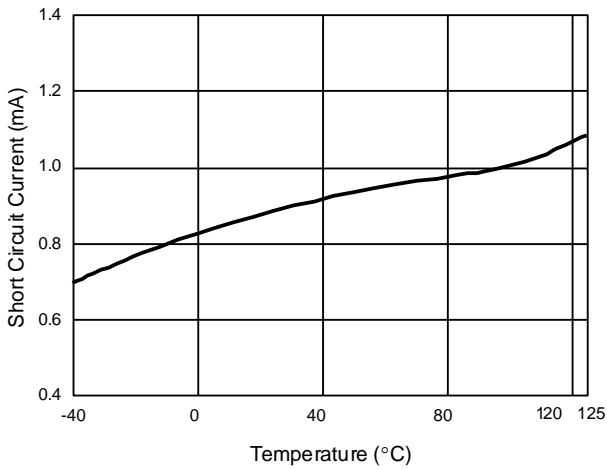

Fig. 7 Short Circuit Current (mA) vs. Temperature

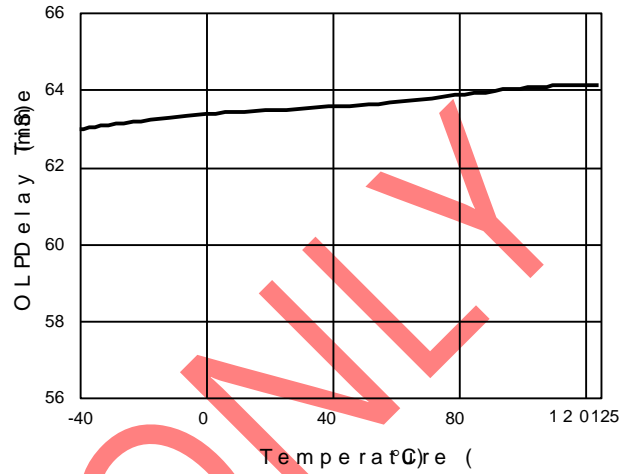

Fig. 8 OLP Delay Time (ms) vs. Temperature

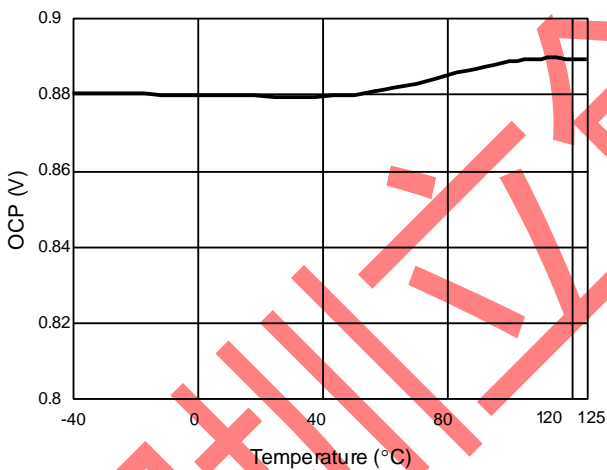

Fig. 9 OCP (V) vs. Temperature

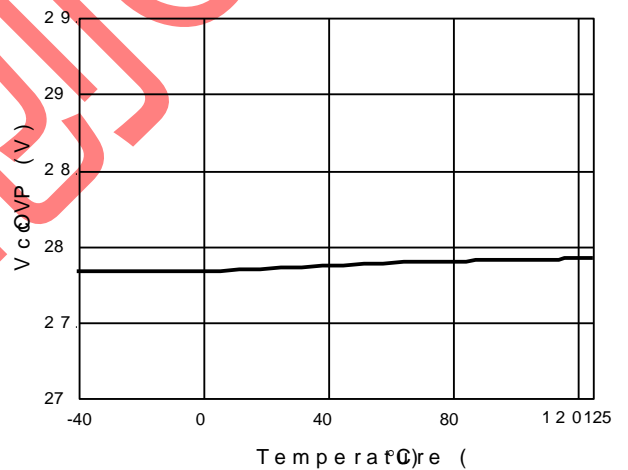

Fig. 10 VcOVP (V) vs. Temperature

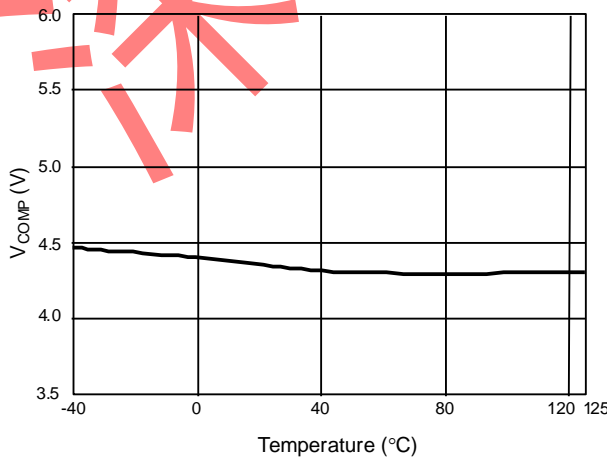

Fig. 11 VCOMP open loop voltage vs. Temperature

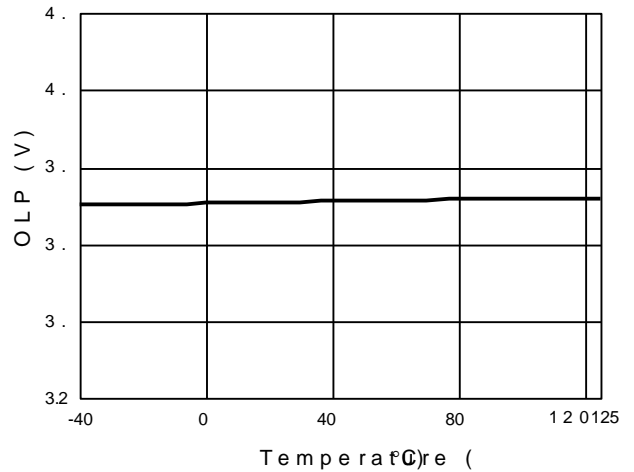

Fig. 12 OLP Trip Level vs. Temperature

Application Information

Start-up Current

The typical start-up current is 8uA. Very low start-up current allows the PWM controller to increase the value of start-up resistor and then reduce the power dissipation on it.

Under-voltage Lockout (UVLO)

A hysteresis UVLO comparator is implemented in GR8836, then the turn-on and turn-off thresholds level are fixed at 15V and 9V respectively. This hysteresis shown in Fig.13 ensures that the start-up capacitor will be adequate to supply the chip during start-up.

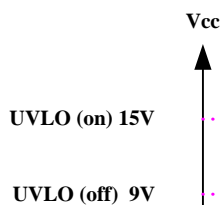

Fig.13

Soft Start

During initial power on, the GR8836 provides soft start function. It effectively suppresses the start up peak current to reduce the power MOSFET drain voltage especially at high line.

Oscillator

The maximum duty-cycle of internal oscillator is limited about 75% to avoid the transformer saturation. The frequency of the oscillator is decided by an external resistor connected from RT pin to ground.

$$f_{osc} = 6500\text{KHz}/R \text{ (Kohm)}$$

Where R is the resistor connected at RT pin. A 100Kohm resistor results in 65KHz switching frequency. The recommended range of oscillation

frequency is 50 KHz~130 KHz.

Green-Mode Operation

When the load decreases to an extent, the frequency of the controller will decrease so as to reduce the system power consumption. The minimum frequency is about 20 KHz, which is outside the audio range.

Leading-edge Blanking (LEB)

Each time the power MOSFET is switched on, a turn-on spike will inevitably occur at the sense resistor. To avoid fault trigger, a 350ns leading-edge blanking time is built in. Conventional RC filtering can therefore be omitted. During this blanking period, the current-limit comparator is disabled and can not switch off the gate driver.

Internal Slope Compensation

A built-in slope compensation circuit is constructed in GR8836. When the switch is on, a ramp voltage is added to the sensed voltage across the CS pin, which helps to stabilize the system and prevent sub-harmonic oscillations.

Over-load Protection (OLP)

The controller has over load protection function. An internal circuit detects the load level, when the load is larger than a threshold and the condition lasts more than 60ms, the gate output will keep low level. Then VCC decreases below UVLO off level, the controller resets again. Fig.14 shows the waveform of the OLP operation.

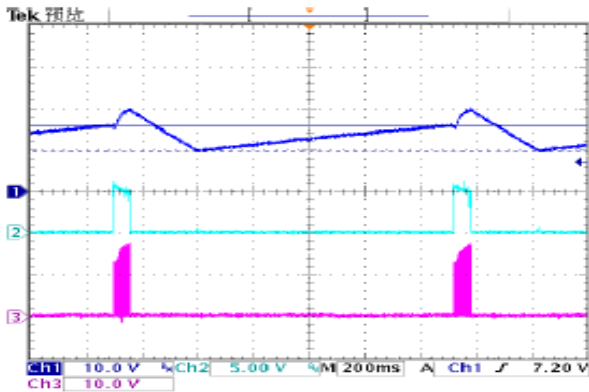

Fig.14

Over-voltage Protection (OVP) on VCC

To prevent power MOSFET from being damaged, the GR8836 is implemented an OVP function on VCC. When the VCC voltage is higher than the OVP threshold voltage, the output gate driver circuit will be shut down immediately to stop the switching of power MOSFET.

The VCC OVP function is an auto-recovery type protection. If OVP happens, the pulses will be stopped and recover at the next UVLO on. The GR8836 is working in a hiccup mode.

Improve EOS Immunity on VCC Pin

If the auxiliary power supplies the GR8836 is too high above 20V, to prevent the GR8836 from being damaged due to over stress of unexpected environmental energy such as ESD or surge, the user could add a resistor on VCC pin to improve the immunity. The value is around few tens of Ohms. A 51 Ohm is recommended.

Gate Clamp

Driver output is clamped by an internal 18V clamping circuit to prevent from undesired over-voltage gate signals. And under the conditions listed below, the gate output will turn off immediately to protect the power circuit.

Fault Protection

There are several critical protections integrated in the

- . CS pin floating

- . RT pin floating
- . RT pin short to ground
- . Secondary rectify diode short protection
- . Comp pin floating

VCC Mode Operation

In order to avoid the output voltage shut down by load changing from full to no load, the GR8836 is built-in the VCC mode function. When the load from full changes to no load, the output voltage will overshoot and pull low the COMP pin by feedback loop. Thus the duty will disappear and no power delivers to the secondary. If there is without any mechanism to prevent this situation, the VCC pin voltage will down to UVLO off and the IC will re-start again. In the GR8836, before the VCC is down to UVLO off, it will force the OUT pin outputs the specified duty to pull the VCC higher than UVLO off. The operation is shown in Fig.15.

The VCC mode function is used to prevent the output re-start again when load changes. So never let the system operate on the VCC mode at no load. The system should operate on burst mode, otherwise the input power maybe become larger.

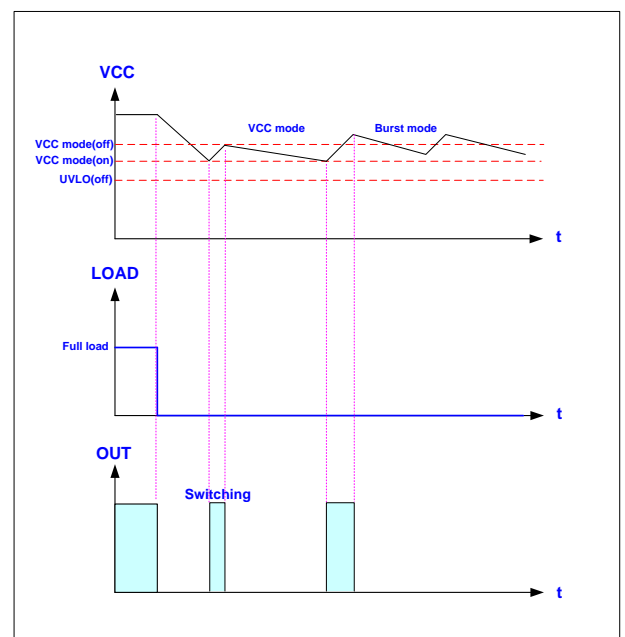
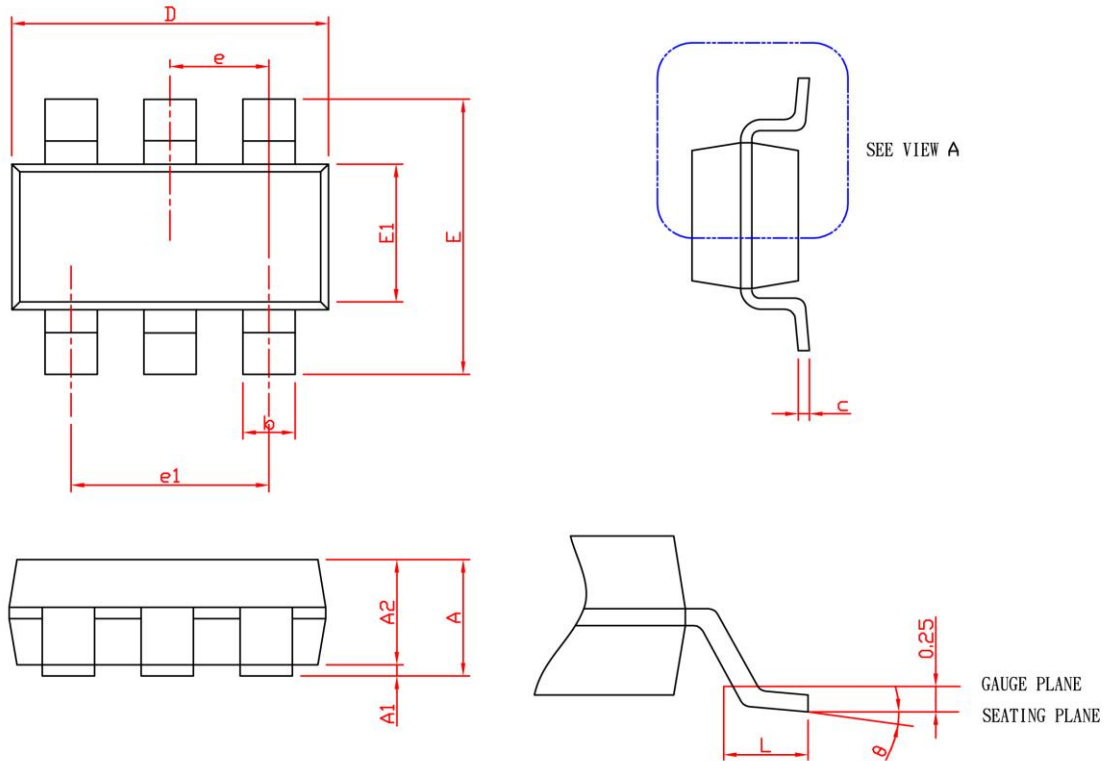

Fig.15

Package Information

SYMBOL	SOT-26			
	MILLIMETERS		INCHES	
	MIN.	MAX.	MIN.	MAX.
A		1.45		0.057
A1	0.00	0.15	0.000	0.006
A2	0.90	1.30	0.035	0.051
b	0.30	0.50	0.012	0.020
c	0.08	0.22	0.003	0.009
D	2.70	3.10	0.106	0.122
E	2.60	3.00	0.102	0.118
E1	1.40	1.80	0.055	0.071
e	0.95 BSC		0.037 BSC	
e1	1.90 BSC		0.075 BSC	
L	0.30	0.60	0.012	0.024
θ	0°	8°	0°	8°

Note : 1. Followed from JEDEC TO-178 AB.

2. Dimension D and E1 do not include mold flash, protrusions or gate burrs. Mold flash, protrusions or gate burrs shall not exceed 10 mil per side.

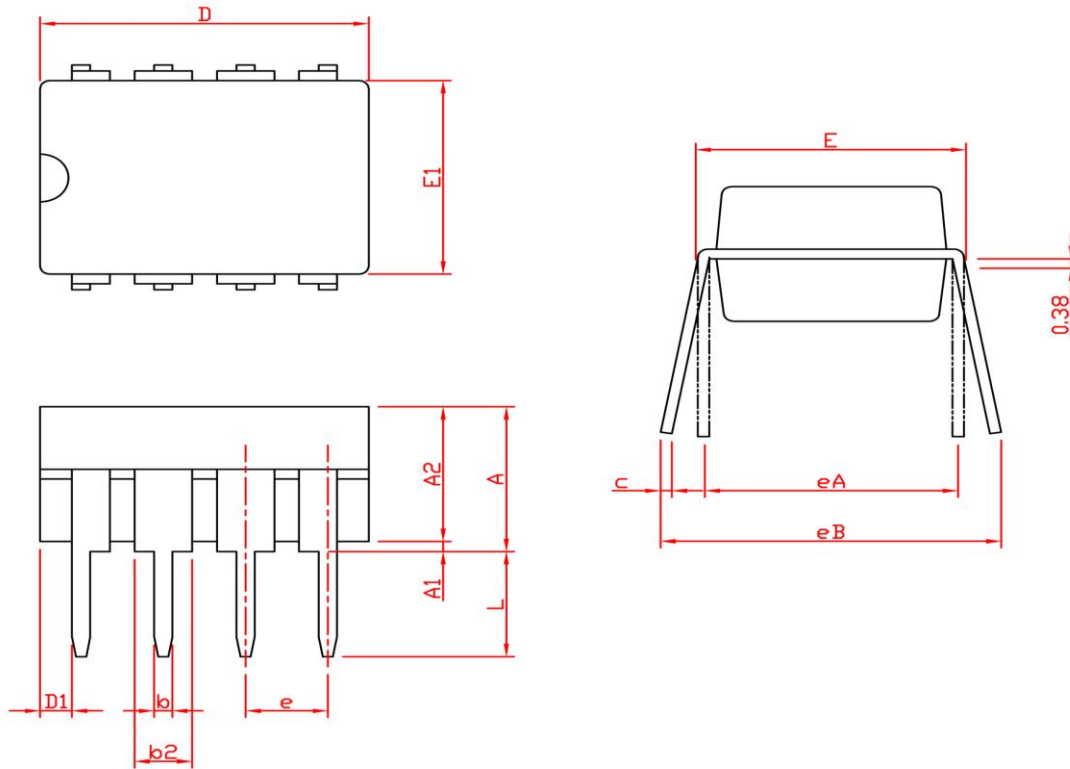
Package Information

SYMBOL	DIP-8			
	MILLIMETERS		INCHES	
	MIN.	MAX.	MIN.	MAX.
A		5.33		0.210
A1	0.38		0.015	
A2	2.92	4.95	0.115	0.195
b	0.36	0.56	0.014	0.022
b2	1.14	1.78	0.045	0.070
c	0.20	0.35	0.008	0.014
D	9.01	10.16	0.355	0.400
D1	0.13		0.005	
E	7.62	8.26	0.300	0.325
E1	6.10	7.11	0.240	0.280
e	2.54 BSC		0.100 BSC	
eA	7.62 BSC		0.300 BSC	
eB		10.92		0.430
L	2.92	3.81	0.115	0.150

Note : 1. Followed from JEDEC MS-001 BA

2. Dimension D, D1 and E1 do not include mold flash or protrusions. Mold flash or protrusions shall not exceed 10

mil.

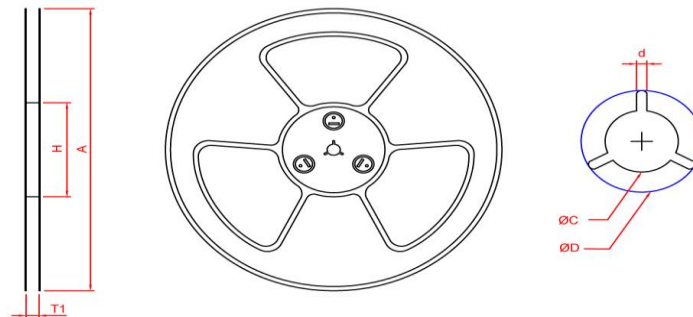
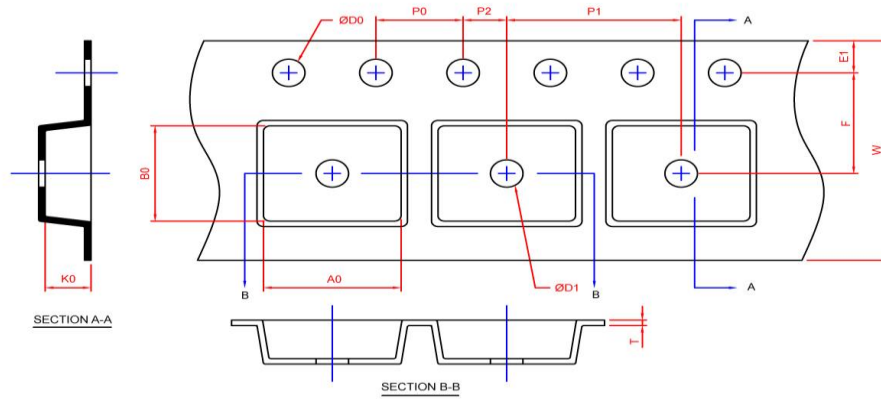
Carrier Tape & Reel Dimensions
SOT-26

Application	A	H	T1	C	d	D	W	E1	F
SOT-26	178.0±2.00	50 MIN.	8.4+2.00 -0.00	13.0+0.50 -0.20	1.5 MIN.	20.2 MIN.	8.0±0.30	1.75±0.10	3.5±0.05
	P0	P1	P2	D0	D1	T	A0	B0	K0
	4.0±0.10	4.0±0.10	2.0±0.05	1.5+0.10 -0.00	1.0 MIN.	0.6+0.00 -0.40	3.20±0.20	3.10±0.20	1.50±0.20

(mm)

Application	Carrier Width	Cover Tape Width	Devices Per Reel
SOT -26	8	5.3	3000

Greenergy OPTO, Inc. reserves the right to make corrections, modifications, enhancements, improvements, and other changes