

4	3	2	1
CATEGORY	DESCRIPTION	P/N #	
CONNECTOR	RJ45 180度DIP全塑 H13(鱼叉版)	MJ886-BX11-HPPDN1A-X	

REV.	ECN NO	DESCRIPTION	REVISED	DATE
A01		New Release	YST	2019.11.16

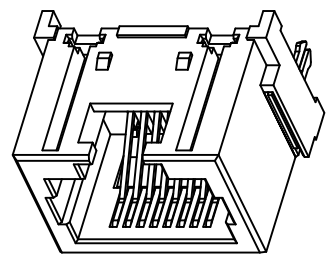
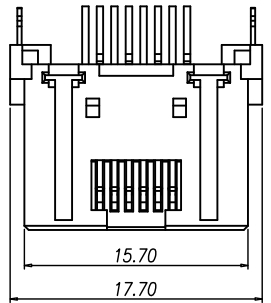

SPECIFICATIONS:

1. Voltage: 125V AC RMS
2. Current Rating: 500mA
3. Contact Resistance: 40mΩ MAX.
4. Insulation Resistance: 100MΩ MIN.
5. Dielectric Withstang Voltage :1000V AC
6. Operature Temperature: -40°C~80°C
7. Durability: 750 Mating Cycles MIN.

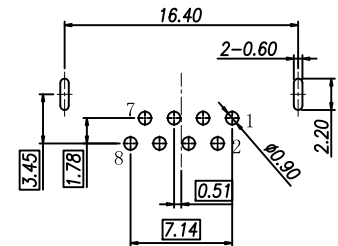
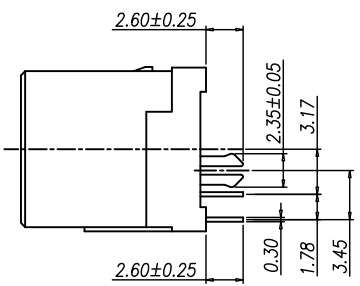
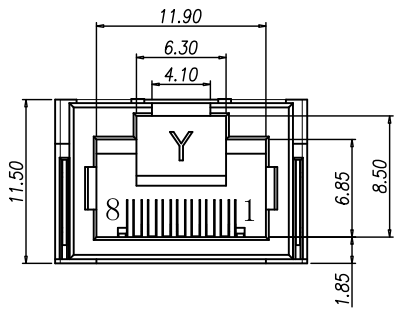

Recommend PCB Layout  
(Jack Top View)  
Tolerance: ±0.05mm  
Recommend PCB Thickness: 1.6mm

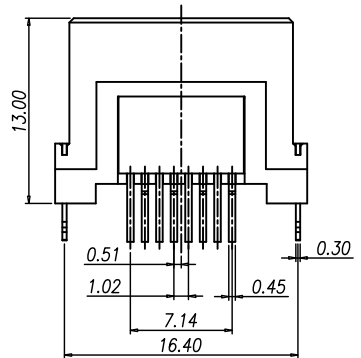

MJ886-BX11-HPPDN1A-X

X	Terminal Plating	X	包装方式
0	Au 1u" Plating	C	卷带包装
1	Au 3u" Plating	P	吸塑盒包装
2	Au 6u" Plating		
3	Au 15u" Plating		

d	ME	2	COPPER ALLOY T=0.3mm	Matte-Tin Plating	
c	Insert	1	LCP UL94V-0	BLACK	
b	Terminal	8	COPPER ALLOY T=0.3mm	Au/Matte-Tin Plating	
a	Housing	1	PBT UL94V-0	BLACK	
NO.	PART NAME	Q'TY	MATERIAL	PLATING & COLOR	Remark

UNLESS OTHERWISE SPECIFIED TOLERANCES

DECIMALS: X :±0.5, X.X :±0.3, X.XX :±0.2

ANGLES: X :±2°, X.X :±1°

**東莞市合陵電子有限公司**  
**DongGuan HeLing Electronic Co.,LTD**

SCALE:1/1 UNIT: mm DWG.NO:

SIZE: A3 PAGE:1 OF 1 REV:A01

APPROVED BY	CHECKED BY	PREPARED BY
DICK	XSY	YST

**CUSTOMER COPY**