

AMC1311x-Q1 High-Impedance, 2-V Input, Reinforced Isolated Amplifiers

1 Features

- Qualified for Automotive Applications
- AEC-Q100 Qualified With the Following Results:
 - Device Temperature Grade 1: -40°C to 125°C Ambient Operating Temperature Range
 - Device HBM ESD Classification Level 2
 - Device CDM ESD Classification Level C6
- 2-V, High-Impedance Input Voltage Range Optimized for Isolated Voltage Measurement
- Low Offset Error and Drift:
 - AMC1311B-Q1: $\pm 1.5\text{ mV}$ (max), $\pm 15\ \mu\text{V}/^{\circ}\text{C}$ (max)
 - AMC1311-Q1: $\pm 9.9\text{ mV}$ (max), $\pm 20\ \mu\text{V}/^{\circ}\text{C}$ (typ)
- Fixed Gain: 1
- Very Low Gain Error and Drift:
 - AMC1311B-Q1: $\pm 0.3\%$ (max), $\pm 45\text{ ppm}/^{\circ}\text{C}$ (max)
 - AMC1311-Q1: $\pm 1\%$ (max), $\pm 30\text{ ppm}/^{\circ}\text{C}$ (typ)
- Low Nonlinearity and Drift: 0.01%, 1 ppm/ $^{\circ}\text{C}$ (typ)
- 3.3-V Operation on High-Side (AMC1311B-Q1)
- Missing High-Side Supply Indication
- Safety-Related Certifications:
 - 7000- V_{PK} Reinforced Isolation per DIN V VDE V 0884-11 (VDE V 0884-11): 2017-01
 - 5000- V_{RMS} Isolation for 1 Minute per UL1577
 - CAN/CSA No. 5A-Component Acceptance Service Notice

2 Applications

- Isolated Voltage Sensing In:
 - Traction Inverters
 - Onboard Chargers
 - DC/DC Converters

3 Description

The AMC1311-Q1 is a precision, isolated amplifier with an output separated from the input circuitry by an isolation barrier that is highly resistant to magnetic interference. This barrier is certified to provide reinforced galvanic isolation of up to 7 kV_{PEAK} according to VDE V 0884-11 and UL1577. Used in conjunction with isolated power supplies, this isolated amplifier separates parts of the system that operate on different common-mode voltage levels and protects lower-voltage parts from damage.

The high-impedance input of the AMC1311-Q1 is optimized for connection to high-voltage resistive dividers or other voltage signal sources with high output resistance. The excellent performance of the device supports accurate, low temperature drift voltage or temperature sensing and control in closed-loop systems. The integrated missing high-side supply voltage detection feature simplifies system-level design and diagnostics.

The AMC1311-Q1 is offered with two performance grade options: AMC1311-Q1 and AMC1311B-Q1.

Device Information⁽¹⁾

PART NUMBER	PACKAGE	BODY SIZE (NOM)
AMC1311x-Q1	SOIC (8)	5.85 mm x 7.50 mm

(1) For all available packages, see the orderable addendum at the end of the data sheet.

Simplified Schematic

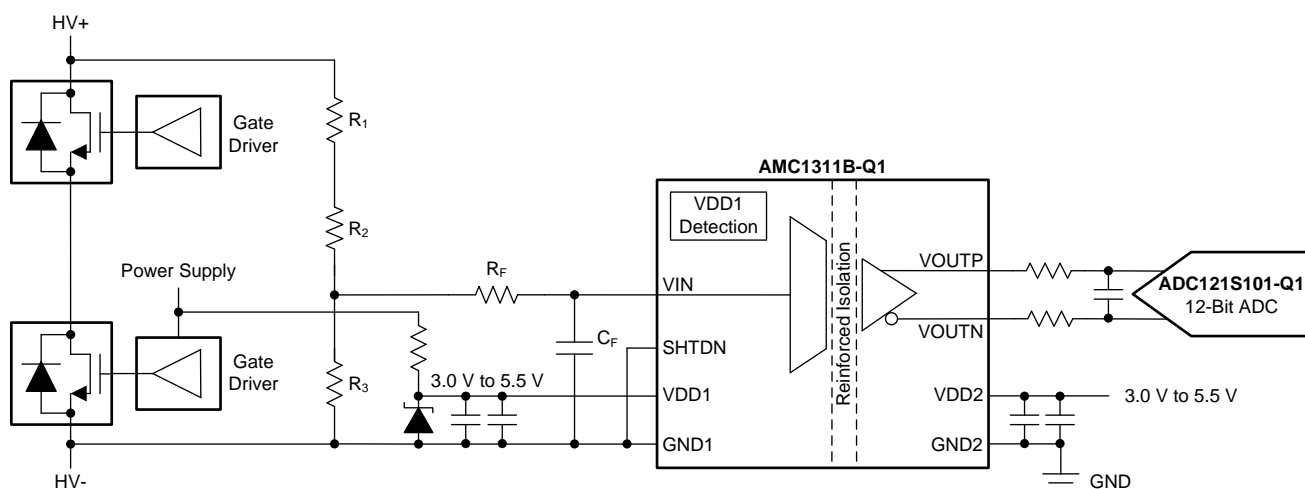

Table of Contents

1 Features	1	8.1 Overview	19
2 Applications	1	8.2 Functional Block Diagram	19
3 Description	1	8.3 Feature Description	19
4 Revision History	2	8.4 Device Functional Modes	21
5 Device Comparison Table	3	9 Application and Implementation	22
6 Pin Configuration and Functions	3	9.1 Application Information	22
7 Specifications	4	9.2 Typical Application	22
7.1 Absolute Maximum Ratings	4	9.3 Do's and Don'ts	24
7.2 ESD Ratings	4	10 Power Supply Recommendations	25
7.3 Recommended Operating Conditions	4	11 Layout	26
7.4 Thermal Information	5	11.1 Layout Guidelines	26
7.5 Power Ratings	5	11.2 Layout Example	26
7.6 Insulation Specifications	6	12 Device and Documentation Support	27
7.7 Safety-Related Certifications	7	12.1 Documentation Support	27
7.8 Safety Limiting Values	7	12.2 Receiving Notification of Documentation Updates	27
7.9 Electrical Characteristics	8	12.3 Community Resources	27
7.10 Switching Characteristics	10	12.4 Trademarks	27
7.11 Insulation Characteristics Curves	11	12.5 Electrostatic Discharge Caution	27
7.12 Typical Characteristics	12	12.6 Glossary	27
8 Detailed Description	19	13 Mechanical, Packaging, and Orderable Information	28

4 Revision History

NOTE: Page numbers for previous revisions may differ from page numbers in the current version.

Changes from Original (March 2018) to Revision A	Page
• Released to production	1

5 Device Comparison Table

PARAMETER	AMC1311B-Q1	AMC1311-Q1
High-side supply voltage, VDD1	3.0 V to 5.5 V	4.5 V to 5.5 V
Specified ambient temperature, T _A	–40°C to +125°C	–40°C to +125°C
Input offset voltage, V _{OS}	4.5 V ≤ VDD1 ≤ 5.5 V	±1.5 mV
	3.0 V ≤ VDD1 ≤ 5.5 V	±2.5 mV
		Not applicable
Input offset drift, TC _{V_{OS}}	±3 μV/°C (typ), ±15 μV/°C (max)	±20 μV/°C (typ)
Gain error, E _G	±0.3%	±1%
Gain error drift, TC _{E_G}	±5 ppm/°C (typ), ±45 ppm/°C (max)	±30 ppm/°C (typ)
Common-mode transient immunity, CMTI	75 kV/μs (min)	15 kV/μs (min)

6 Pin Configuration and Functions

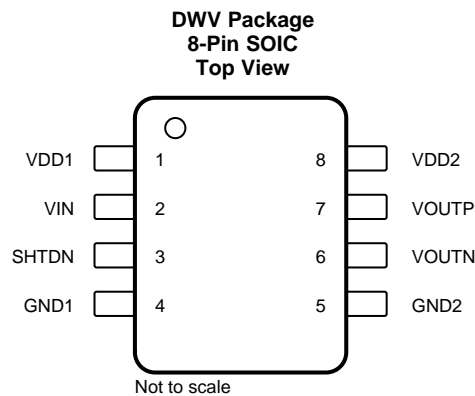

Pin Functions

PIN		TYPE	DESCRIPTION
NO.	NAME		
1	VDD1	—	High-side power supply, 3.0 V to 5.5 V for the AMC1311B-Q1 (4.5 V to 5.5 V for the AMC1311-Q1), relative to GND1. See the Power Supply Recommendations section for power-supply decoupling recommendations.
2	VIN	I	Analog input
3	SHTDN	I	Shutdown input, active high, with internal pullup resistor (typical value: 100 kΩ)
4	GND1	—	High-side analog ground
5	GND2	—	Low-side analog ground
6	VOUTN	O	Inverting analog output
7	VOUTP	O	Noninverting analog output
8	VDD2	—	Low-side power supply, 3.0 V to 5.5 V, relative to GND2. See the Power Supply Recommendations section for power-supply decoupling recommendations.

7 Specifications

7.1 Absolute Maximum Ratings⁽¹⁾

		MIN	MAX	UNIT
Power-supply voltage	VDD1 to GND1	–0.3	6.5	V
	VDD2 to GND2	–0.3	6.5	
Input voltage	VIN	GND1 – 6	VDD1 + 0.5	V
	SHTDN	GND1 – 0.5	VDD1 + 0.5	
Output voltage	VOOTP, VOUTN	GND2 – 0.5	VDD2 + 0.5	V
Input current	Continuous, any pin except power-supply pins	–10	10	mA
Temperature	Junction, T _J		150	°C
	Storage, T _{stg}	–65	150	

(1) Stresses beyond those listed under *Absolute Maximum Ratings* may cause permanent damage to the device. These are stress ratings only, which do not imply functional operation of the device at these or any other conditions beyond those indicated under *Recommended Operating Conditions*. Exposure to absolute-maximum-rated conditions for extended periods may affect device reliability.

7.2 ESD Ratings

		VALUE	UNIT
V _(ESD) Electrostatic discharge	Human-body model (HBM), per AEC Q100-002 ⁽¹⁾	±2000	V
	Charged-device model (CDM), per AEC Q100-011	±1000	

(1) AEC Q100-002 indicates that HBM stressing shall be in accordance with the ANSI/ESDA/JEDEC JS-001 specification.

7.3 Recommended Operating Conditions

over operating ambient temperature range (unless otherwise noted)

		MIN	NOM	MAX	UNIT
POWER SUPPLY					
High-side power supply	VDD1 to GND1, AMC1311-Q1	4.5	5	5.5	V
	VDD1 to GND1, AMC1311B-Q1	3.0	5	5.5	
Low-side power supply	VDD2 to GND2	3.0	3.3	5.5	V
ANALOG INPUT					
Absolute input voltage	VIN to GND1	–2		VDD1	V
V _{FSR} Specified linear input full-scale voltage	VIN to GND1	–0.1		2	V
V _{Clipping} Input voltage before clipping output	VIN to GND1		2.516		V
DIGITAL INPUT					
Input voltage	SHTDN	GND1		VDD1	V
TEMPERATURE RANGE					
T _A Specified ambient temperature		–40		125	°C

7.4 Thermal Information

THERMAL METRIC ⁽¹⁾		AMC1311x-Q1	UNIT
		DWV (SOIC)	
		8 PINS	
$R_{\theta JA}$	Junction-to-ambient thermal resistance	84.6	°C/W
$R_{\theta JC(top)}$	Junction-to-case (top) thermal resistance	28.3	°C/W
$R_{\theta JB}$	Junction-to-board thermal resistance	41.1	°C/W
Ψ_{JT}	Junction-to-top characterization parameter	4.9	°C/W
Ψ_{JB}	Junction-to-board characterization parameter	39.1	°C/W
$R_{\theta JC(bot)}$	Junction-to-case (bottom) thermal resistance	N/A	°C/W

(1) For more information about traditional and new thermal metrics, see the [Semiconductor and IC Package Thermal Metrics](#) application report.

7.5 Power Ratings

PARAMETER		TEST CONDITIONS	VALUE	UNIT
P_D	Maximum power dissipation (both sides)	VDD1 = VDD2 = 5.5 V	97.9	mW
		VDD1 = VDD2 = 3.6 V, AMC1311B-Q1 only	56.16	
P_{D1}	Maximum power dissipation (high-side supply)	VDD1 = 5.5 V	53.35	mW
		VDD1 = 3.6 V, AMC1311B-Q1 only	30.24	
P_{D2}	Maximum power dissipation (low-side supply)	VDD2 = 5.5 V	44.55	mW
		VDD2 = 3.6 V	25.92	

7.6 Insulation Specifications

over operating ambient temperature range (unless otherwise noted)

PARAMETER		TEST CONDITIONS	VALUE	UNIT
GENERAL				
CLR	External clearance ⁽¹⁾	Shortest pin-to-pin distance through air	≥ 9	mm
CPG	External creepage ⁽¹⁾	Shortest pin-to-pin distance across the package surface	≥ 9	mm
DTI	Distance through insulation	Minimum internal gap (internal clearance) of the double insulation (2 × 0.0105 mm)	≥ 0.021	mm
CTI	Comparative tracking index	DIN EN 60112 (VDE 0303-11); IEC 60112	≥ 600	V
	Material group	According to IEC 60664-1	I	
	Overvoltage category per IEC 60664-1	Rated mains voltage ≤ 300 V _{RMS}	I-IV	
		Rated mains voltage ≤ 600 V _{RMS}	I-IV	
		Rated mains voltage ≤ 1000 V _{RMS}	I-III	
DIN V VDE V 0884-11 (VDE V 0884-11): 2017-01⁽²⁾				
V _{IORM}	Maximum repetitive peak isolation voltage	At ac voltage (bipolar)	2121	V _{PK}
V _{IOWM}	Maximum-rated isolation working voltage	At ac voltage (sine wave)	1500	V _{RMS}
		At dc voltage	2121	V _{DC}
V _{IOTM}	Maximum transient isolation voltage	V _{TEST} = V _{IOTM} , t = 60 s (qualification test)	7000	V _{PK}
		V _{TEST} = 1.2 × V _{IOTM} , t = 1 s (100% production test)	8400	
V _{IOSM}	Maximum surge isolation voltage ⁽³⁾	Test method per IEC 60065, 1.2/50-μs waveform, V _{TEST} = 1.6 × V _{IOSM} = 12800 V _{PK} (qualification)	8000	V _{PK}
q _{pd}	Apparent charge ⁽⁴⁾	Method a, after input/output safety test subgroup 2 / 3, V _{ini} = V _{IOTM} , t _{ini} = 60 s, V _{pd(m)} = 1.2 × V _{IORM} = 2545 V _{PK} , t _m = 10 s	≤ 5	pC
		Method a, after environmental tests subgroup 1, V _{ini} = V _{IOTM} , t _{ini} = 60 s, V _{pd(m)} = 1.6 × V _{IORM} = 3394 V _{PK} , t _m = 10 s	≤ 5	
		Method b1, at routine test (100% production) and preconditioning (type test), V _{ini} = V _{IOTM} , t _{ini} = 1 s, V _{pd(m)} = 1.875 × V _{IORM} = 3977 V _{PK} , t _m = 1 s	≤ 5	
C _{IO}	Barrier capacitance, input to output ⁽⁵⁾	V _{IO} = 0.5 V _{PP} at 1 MHz	~1	pF
R _{IO}	Insulation resistance, input to output ⁽⁵⁾	V _{IO} = 500 V at T _A = 25°C	> 10 ¹²	Ω
		V _{IO} = 500 V at 100°C ≤ T _A ≤ 125°C	> 10 ¹¹	
		V _{IO} = 500 V at T _S = 150°C	> 10 ⁹	
	Pollution degree		2	
	Climatic category		55/125/21	
UL1577				
V _{ISO}	Withstand isolation voltage	V _{TEST} = V _{ISO} = 5000 V _{RMS} or 7000 V _{DC} , t = 60 s (qualification), V _{TEST} = 1.2 × V _{ISO} = 6000 V _{RMS} , t = 1 s (100% production test)	5000	V _{RMS}

- (1) Apply creepage and clearance requirements according to the specific equipment isolation standards of an application. Care must be taken to maintain the creepage and clearance distance of a board design to ensure that the mounting pads of the isolator on the printed circuit board (PCB) do not reduce this distance. Creepage and clearance on a PCB become equal in certain cases. Techniques such as inserting grooves and ribs on the PCB are used to help increase these specifications.
- (2) This coupler is suitable for *safe electrical insulation* only within the safety ratings. Compliance with the safety ratings shall be ensured by means of suitable protective circuits.
- (3) Testing is carried out in air or oil to determine the intrinsic surge immunity of the isolation barrier.
- (4) Apparent charge is electrical discharge caused by a partial discharge (pd).
- (5) All pins on each side of the barrier are tied together, creating a two-pin device.

7.7 Safety-Related Certifications

VDE	UL
Certified according to DIN V VDE V 0884-11 (VDE V 0884-11): 2017-01, DIN EN 60950-1 (VDE 0805 Teil 1): 2014-08, and DIN EN 60065 (VDE 0860): 2005-11	Recognized under 1577 component recognition and CSA component acceptance NO 5 programs
Reinforced insulation	Single protection
Certificate number: 40040142	File number: E181974

7.8 Safety Limiting Values

Safety limiting intends to minimize potential damage to the isolation barrier upon failure of input or output (I/O) circuitry. A failure of the I/O may allow low resistance to ground or the supply and, without current limiting, dissipate sufficient power to overheat the die and damage the isolation barrier, potentially leading to secondary system failures.

PARAMETER	TEST CONDITIONS	MIN	TYP	MAX	UNIT
I _S Safety input, output, or supply current	R _{θJA} = 84.6°C/W, T _J = 150°C, T _A = 25°C, VDD1 = VDD2 = 5.5 V, see Figure 2			268	mA
	R _{θJA} = 84.6°C/W, T _J = 150°C, T _A = 25°C, VDD1 = VDD2 = 3.6 V, AMC1311B-Q1 only, see Figure 2			410	
P _S Safety input, output, or total power ⁽¹⁾	R _{θJA} = 84.6°C/W, T _J = 150°C, T _A = 25°C, see Figure 3			1477	mW
T _S Maximum safety temperature				150	°C

(1) Input, output, or the sum of input and output power must not exceed this value.

The maximum safety temperature is the maximum junction temperature specified for the device. The power dissipation and junction-to-air thermal impedance of the device installed in the application hardware determines the junction temperature. The assumed junction-to-air thermal resistance in the [Thermal Information](#) table is that of a device installed on a high-K test board for leaded surface-mount packages. The power is the recommended maximum input voltage times the current. The junction temperature is then the ambient temperature plus the power times the junction-to-air thermal resistance.

7.9 Electrical Characteristics

minimum and maximum specifications of the AMC1311-Q1 apply from $T_A = -40^{\circ}\text{C}$ to $+125^{\circ}\text{C}$, $V_{DD1} = 4.5\text{ V}$ to 5.5 V , $V_{DD2} = 3.0\text{ V}$ to 5.5 V , $V_{IN} = -0.1\text{ V}$ to 2 V , and $\text{SHTDN} = \text{GND1} = 0\text{ V}$; minimum and maximum specifications of the AMC1311B-Q1 apply from $T_A = -40^{\circ}\text{C}$ to $+125^{\circ}\text{C}$, $V_{DD1} = 3.0\text{ V}$ to 5.5 V , $V_{DD2} = 3.0\text{ V}$ to 5.5 V , $V_{IN} = -0.1\text{ V}$ to 2 V , and $\text{SHTDN} = \text{GND1} = 0\text{ V}$; typical specifications are at $T_A = 25^{\circ}\text{C}$, $V_{DD1} = 5\text{ V}$, and $V_{DD2} = 3.3\text{ V}$ (unless otherwise noted)

PARAMETER		TEST CONDITIONS	MIN	TYP	MAX	UNIT
ANALOG INPUT						
V_{OS}	Input offset voltage ⁽¹⁾	AMC1311-Q1, initial, at $T_A = 25^{\circ}\text{C}$, $V_{IN} = \text{GND1}$	-9.9	± 0.4	9.9	mV
		AMC1311B-Q1, initial, at $T_A = 25^{\circ}\text{C}$, $V_{IN} = \text{GND1}$, $4.5\text{ V} \leq V_{DD1} \leq 5.5\text{ V}$	-1.5	± 0.4	1.5	
		AMC1311B-Q1, initial, at $T_A = 25^{\circ}\text{C}$, $V_{IN} = \text{GND1}$, $3.0\text{ V} \leq V_{DD1} \leq 5.5\text{ V}$ ⁽²⁾	-2.5	-1.1	2.5	
TCV_{OS}	Input offset drift ⁽¹⁾	AMC1311-Q1		± 20		$\mu\text{V}/^{\circ}\text{C}$
		AMC1311B-Q1	-15	± 3	15	
C_{IN}	Input capacitance ⁽³⁾	$f_{IN} = 275\text{ kHz}$		7		pF
R_{IN}	Input resistance ⁽³⁾			1		G Ω
I_{IB}	Input bias current	$V_{IN} = \text{GND1}$	-15	3.5	15	nA
TCI_{IB}	Input bias current drift			± 10		$\text{pA}/^{\circ}\text{C}$
ANALOG OUTPUT						
	Nominal gain			1		
E_G	Gain error ⁽¹⁾	AMC1311-Q1, initial, at $T_A = 25^{\circ}\text{C}$	-1%	0.4%	1%	
		AMC1311B-Q1, initial, at $T_A = 25^{\circ}\text{C}$	-0.3%	$\pm 0.05\%$	0.3%	
TCE_G	Gain error drift ⁽¹⁾	AMC1311-Q1		± 30		$\text{ppm}/^{\circ}\text{C}$
		AMC1311B-Q1	-45	± 5	45	
	Nonlinearity ⁽¹⁾		-0.04%	$\pm 0.01\%$	0.04%	
	Nonlinearity drift			1		$\text{ppm}/^{\circ}\text{C}$
THD	Total harmonic distortion	$V_{IN} = 2\text{ V}$, $f_{IN} = 10\text{ kHz}$, $\text{BW} = 100\text{ kHz}$		-87		dB
	Output noise	$V_{IN} = \text{GND1}$, $\text{BW} = 100\text{ kHz}$		220		μV_{RMS}
SNR	Signal-to-noise ratio	$V_{IN} = 2\text{ V}$, $f_{IN} = 1\text{ kHz}$, $\text{BW} = 10\text{ kHz}$	79	82.6		dB
		$V_{IN} = 2\text{ V}$, $f_{IN} = 10\text{ kHz}$, $\text{BW} = 100\text{ kHz}$		70.9		
PSRR	Power-supply rejection ratio ⁽⁴⁾	PSRR vs V_{DD1} , at dc		-65		dB
		PSRR vs V_{DD1} , 100-mV and 10-kHz ripple		-65		
		PSRR vs V_{DD2} , at dc		-85		
		PSRR vs V_{DD2} , 100-mV and 10-kHz ripple		-70		
V_{CMout}	Common-mode output voltage		1.39	1.44	1.49	V
V_{FAILSAFE}	Failsafe differential output voltage	$V_{\text{OUTP}} - V_{\text{OUTN}}$, $\text{SHTDN} = \text{high}$, or $V_{DD1} \leq V_{DD1_{\text{UV}}}$, or V_{DD1} missing		-2.6	-2.5	V
BW	Output bandwidth	AMC1311-Q1	100	220		kHz
		AMC1311B-Q1	220	275		
R_{OUT}	Output resistance	On V_{OUTP} or V_{OUTN}		< 0.2		Ω
	Output short-circuit current			± 13		mA
CMTI	Common-mode transient immunity	$ \text{GND1} - \text{GND2} = 1\text{ kV}$, AMC1311-Q1	15	30		$\text{kV}/\mu\text{s}$
		$ \text{GND1} - \text{GND2} = 1\text{ kV}$, AMC1311B-Q1	75	140		

(1) The typical value includes one sigma statistical variation.

(2) The typical value is at $V_{DD1} = 3.3\text{ V}$.

(3) See the [Analog Input](#) section for more details.

(4) This parameter is output referred.

Electrical Characteristics (continued)

minimum and maximum specifications of the AMC1311-Q1 apply from $T_A = -40^\circ\text{C}$ to $+125^\circ\text{C}$, $V_{DD1} = 4.5\text{ V}$ to 5.5 V , $V_{DD2} = 3.0\text{ V}$ to 5.5 V , $V_{IN} = -0.1\text{ V}$ to 2 V , and $\text{SHTDN} = \text{GND1} = 0\text{ V}$; minimum and maximum specifications of the AMC1311B-Q1 apply from $T_A = -40^\circ\text{C}$ to $+125^\circ\text{C}$, $V_{DD1} = 3.0\text{ V}$ to 5.5 V , $V_{DD2} = 3.0\text{ V}$ to 5.5 V , $V_{IN} = -0.1\text{ V}$ to 2 V , and $\text{SHTDN} = \text{GND1} = 0\text{ V}$; typical specifications are at $T_A = 25^\circ\text{C}$, $V_{DD1} = 5\text{ V}$, and $V_{DD2} = 3.3\text{ V}$ (unless otherwise noted)

PARAMETER		TEST CONDITIONS	MIN	TYP	MAX	UNIT
DIGITAL INPUT (SHTDN Pin: CMOS Logic Family, CMOS With Schmitt-Trigger)						
I_{IN}	Input current	$\text{GND1} \leq V_{\text{SHTDN}} \leq V_{DD1}$	-70		1	μA
C_{IN}	Input capacitance			5		pF
V_{IH}	High-level input voltage		$0.7 \times V_{DD1}$		$V_{DD1} + 0.3$	V
V_{IL}	Low-level input voltage		-0.3		$0.3 \times V_{DD1}$	V
POWER SUPPLY						
V_{DD1UV}	V_{DD1} undervoltage detection threshold voltage	V_{DD1} falling	1.75	2.53	2.7	V
I_{DD1}	High-side supply current	AMC1311B-Q1 only, $3.0\text{ V} \leq V_{DD1} \leq 3.6\text{ V}$, SHTDN = low		6	8.4	mA
		$4.5\text{ V} \leq V_{DD1} \leq 5.5\text{ V}$, SHTDN = low		7.1	9.7	
		SHTDN = high		1.3		μA
I_{DD2}	Low-side supply current	$3.0\text{ V} \leq V_{DD2} \leq 3.6\text{ V}$		5.3	7.2	mA
		$4.5\text{ V} \leq V_{DD2} \leq 5.5\text{ V}$		5.9	8.1	

7.10 Switching Characteristics

over operating ambient temperature range (unless otherwise noted)

PARAMETER	TEST CONDITIONS	MIN	TYP	MAX	UNIT	
t_r	Rise time of VOUTP, VOUTN		1.3		μs	
t_f	Fall time of VOUTP, VOUTN		1.3		μs	
VIN to VOUTN, VOUTP signal delay (50% – 10%)	AMC1311-Q1, unfiltered output, see Figure 1		1.5	2.5	μs	
	AMC1311B-Q1, unfiltered output, see Figure 1		1.0	1.5		
VIN to VOUTN, VOUTP signal delay (50% – 50%)	AMC1311-Q1, unfiltered output, see Figure 1		2.1	3.1	μs	
	AMC1311B-Q1, unfiltered output, see Figure 1		1.6	2.1		
VIN to VOUTN, VOUTP signal delay (50% – 90%)	AMC1311-Q1, unfiltered output, see Figure 1		3.0	4.0	μs	
	AMC1311B-Q1, unfiltered output, see Figure 1		2.5	3.0		
t_{AS}	Analog settling time	VDD1 step to 3.0 V with VDD2 \geq 3.0 V, to VOUTP, VOUTN valid, 0.1% settling		50	100	μs
t_{EN}	Device enable time	SHTDN high to low		50	100	μs
t_{SHTDN}	Shutdown time	SHTDN low to high		3	10	μs

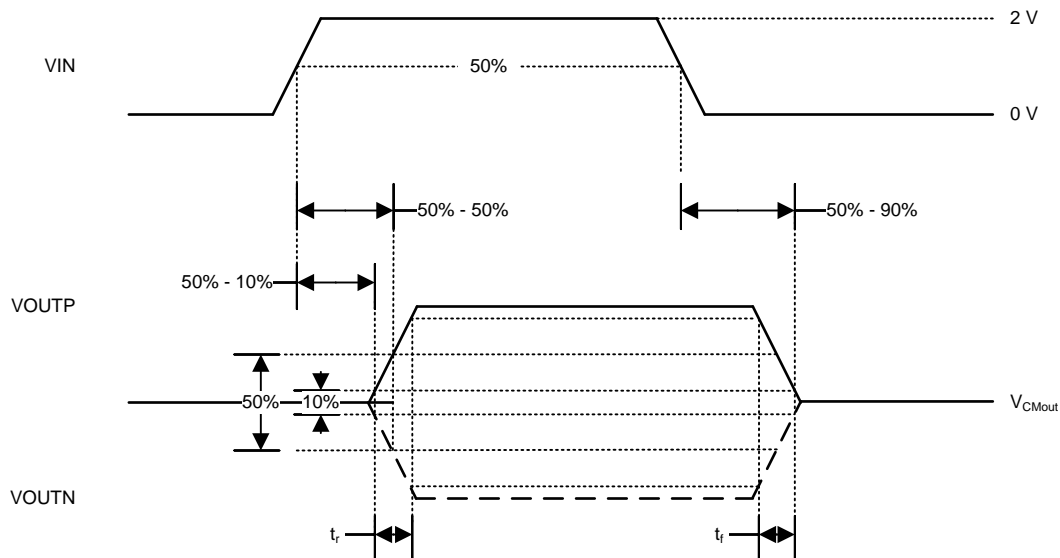
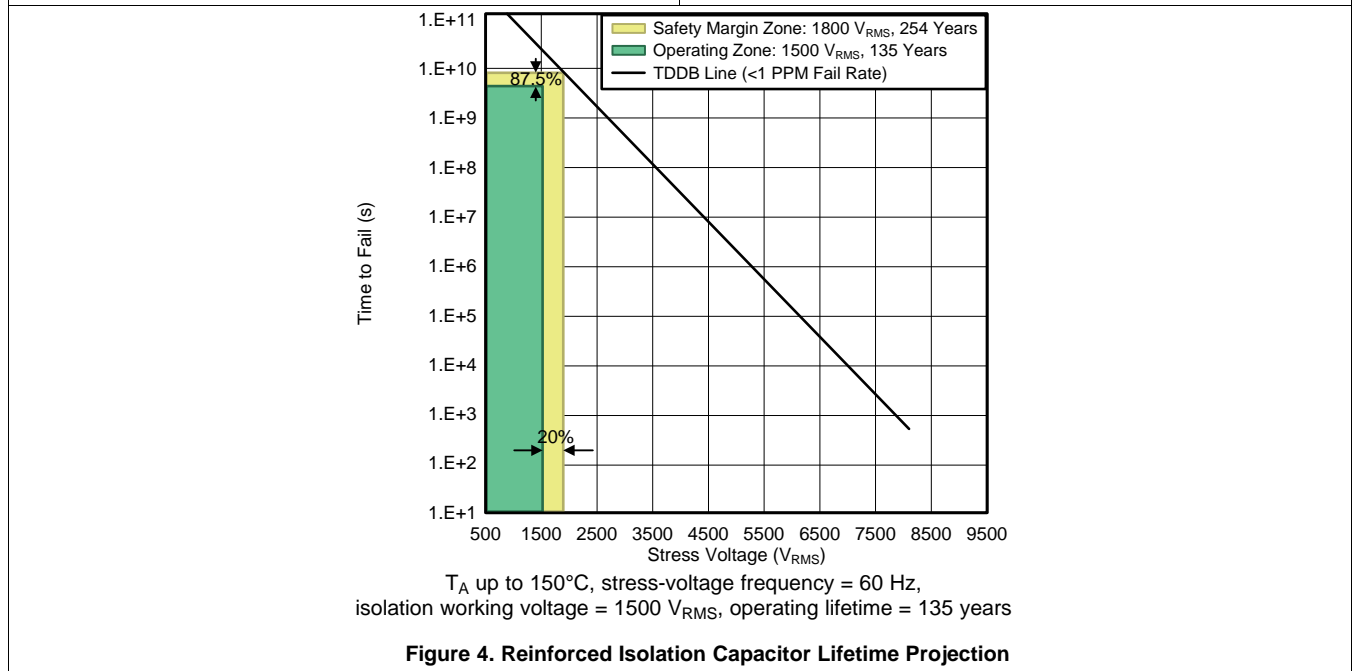
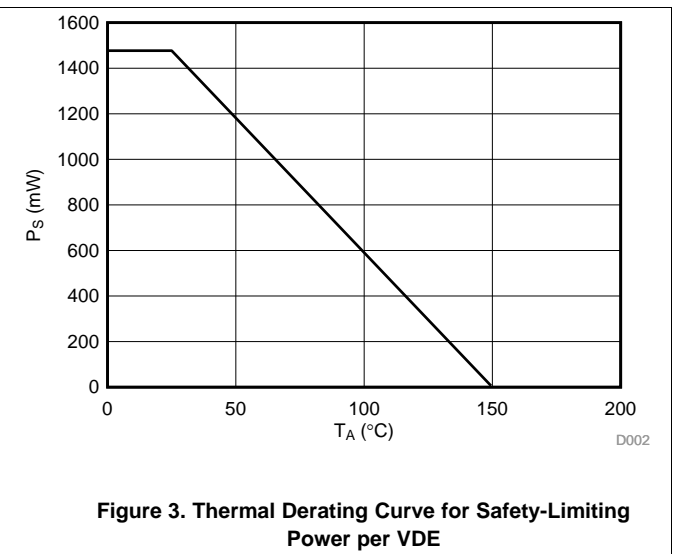
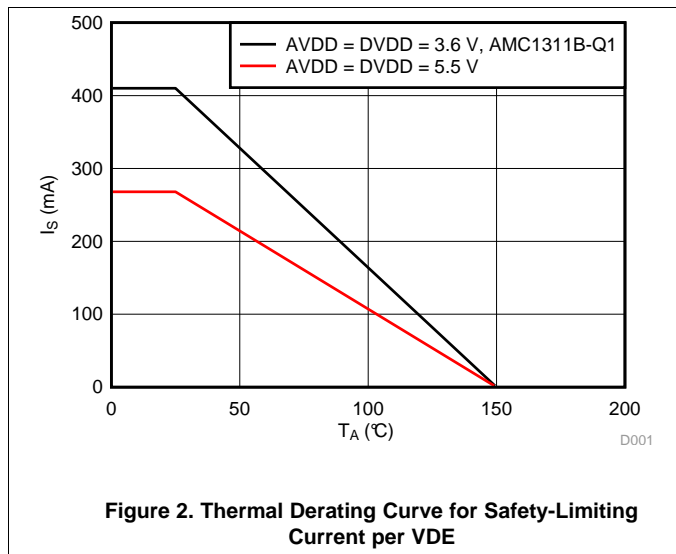

Figure 1. Rise, Fall, and Delay Time Waveforms

7.11 Insulation Characteristics Curves



7.12 Typical Characteristics

at VDD1 = 5 V, VDD2 = 3.3 V, SHTDN = 0 V, f_{IN} = 10 kHz, and BW = 100 kHz (unless otherwise noted)

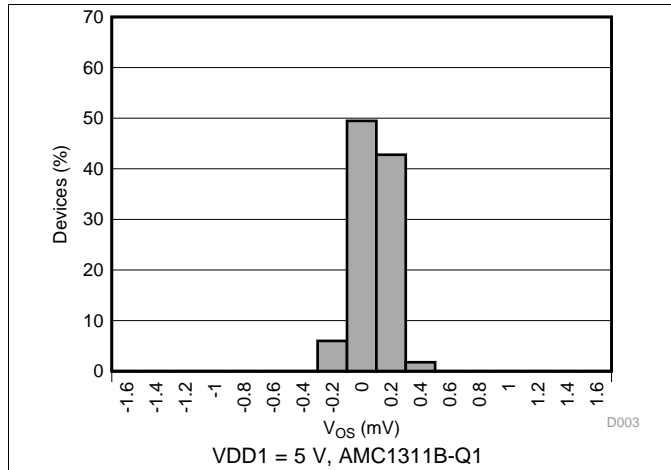

Figure 5. Input Offset Voltage Histogram

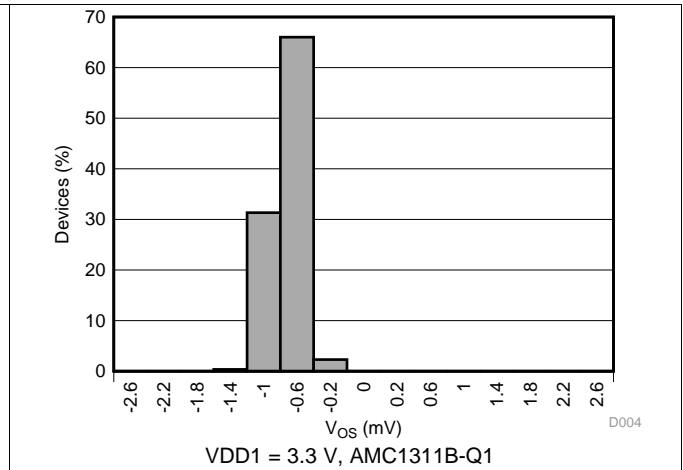

Figure 6. Input Offset Voltage Histogram

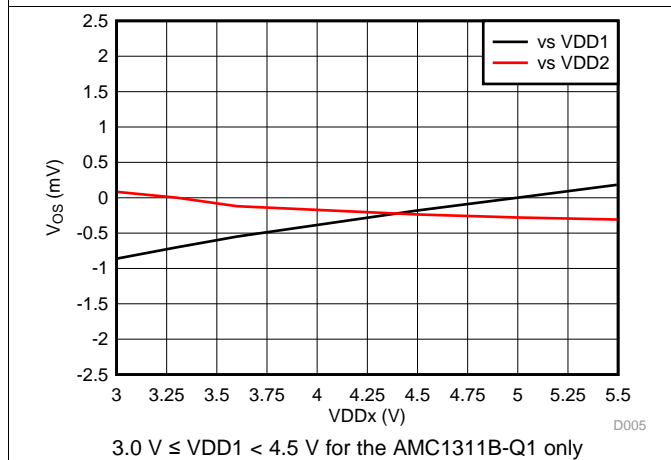

Figure 7. Input Offset Voltage vs Supply Voltage

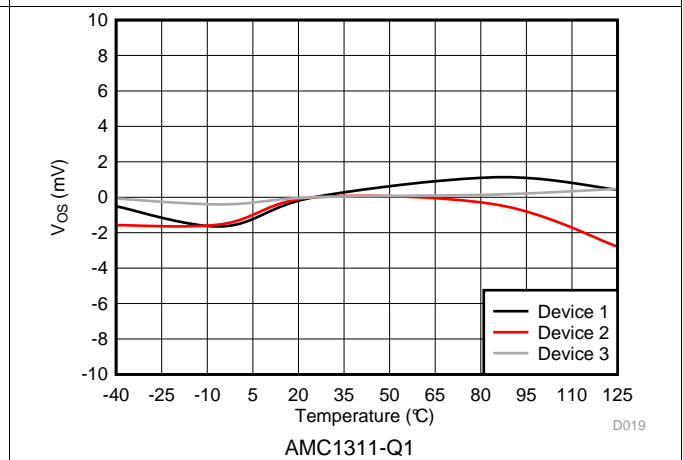

Figure 8. Input Offset Voltage vs Temperature

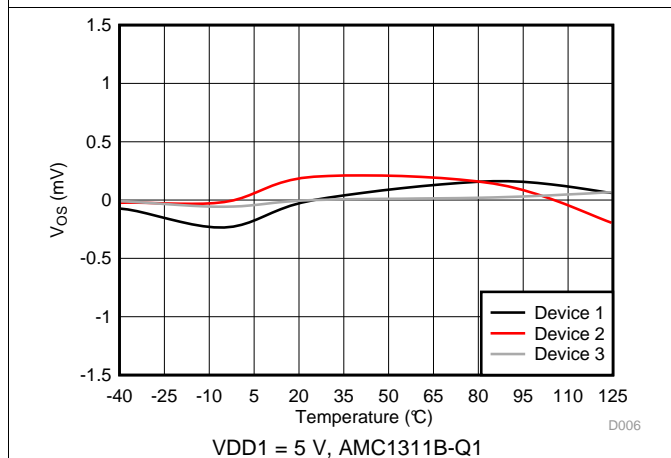

Figure 9. Input Offset Voltage vs Temperature

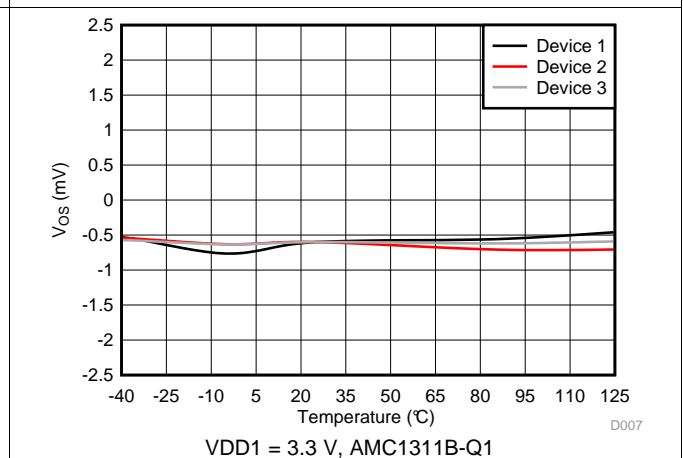

Figure 10. Input Offset Voltage vs Temperature

Typical Characteristics (continued)

at VDD1 = 5 V, VDD2 = 3.3 V, SHTDN = 0 V, $f_{IN} = 10$ kHz, and BW = 100 kHz (unless otherwise noted)

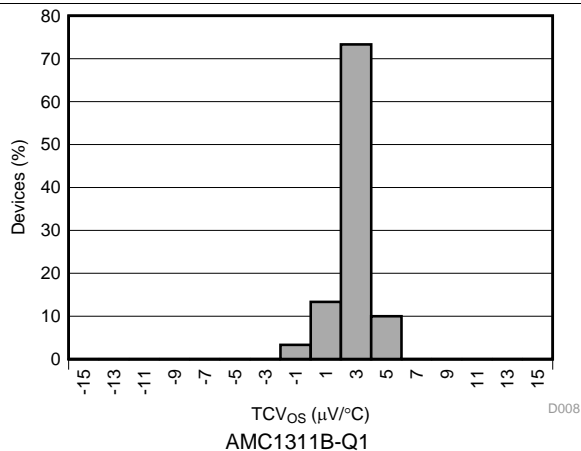

Figure 11. Input Offset Drift Histogram

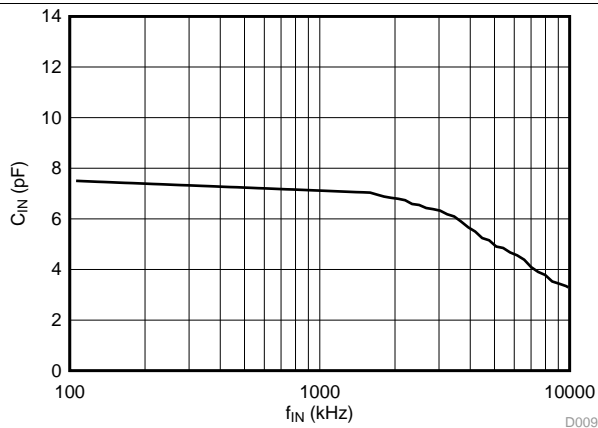
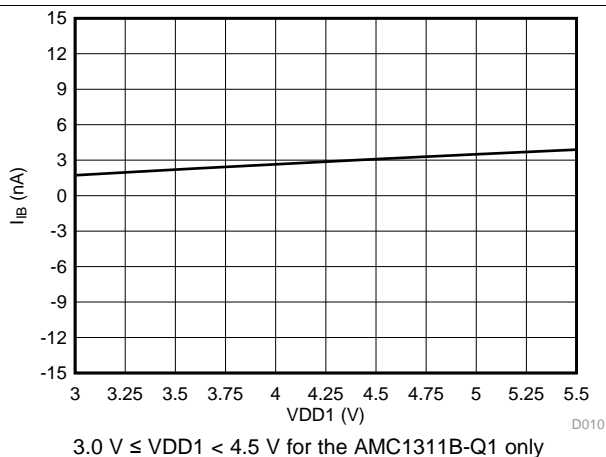

Figure 12. Input Capacitance vs Input Signal Frequency



3.0 V ≤ VDD1 < 4.5 V for the AMC1311B-Q1 only

Figure 13. Input Bias Current vs High-Side Supply Voltage

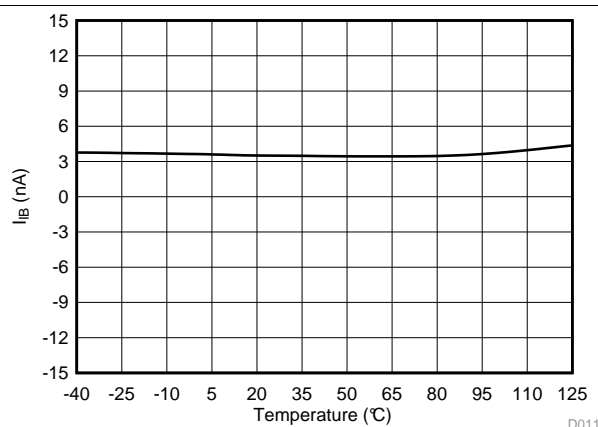

Figure 14. Input Bias Current vs Temperature

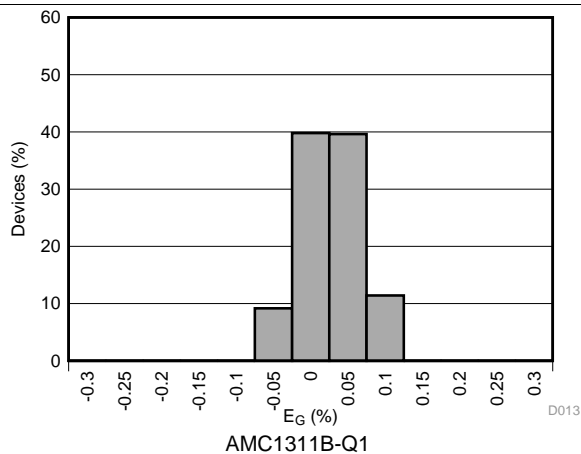
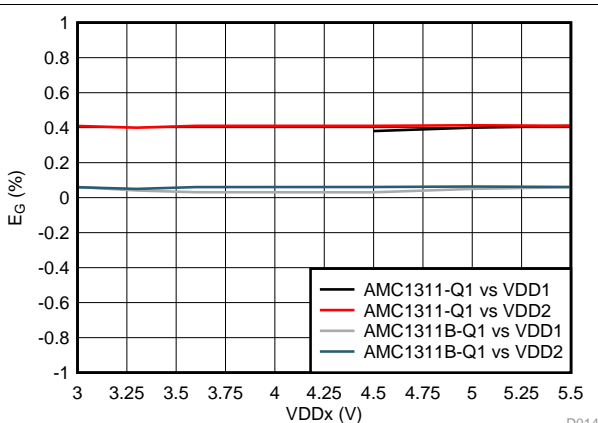

Figure 15. Gain Error Histogram



3.0 V ≤ VDD1 < 4.5 V for the AMC1311B-Q1 only

Figure 16. Gain Error vs Supply Voltage

AMC1311-Q1

SBAS897A – MARCH 2018 – REVISED JUNE 2018

www.ti.com

Typical Characteristics (continued)

at VDD1 = 5 V, VDD2 = 3.3 V, SHTDN = 0 V, $f_{IN} = 10$ kHz, and BW = 100 kHz (unless otherwise noted)

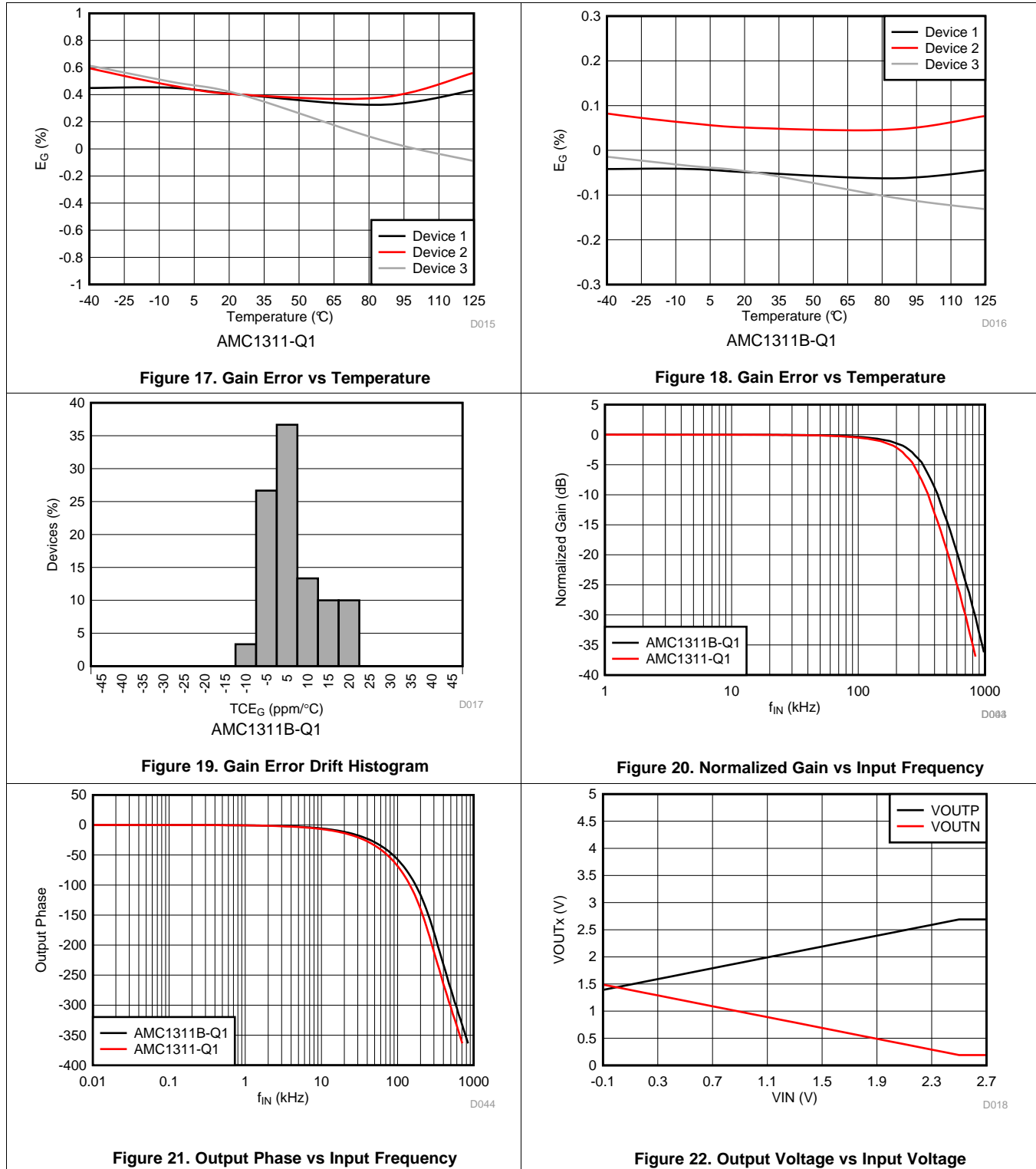

Typical Characteristics (continued)

at VDD1 = 5 V, VDD2 = 3.3 V, SHTDN = 0 V, $f_{IN} = 10$ kHz, and BW = 100 kHz (unless otherwise noted)

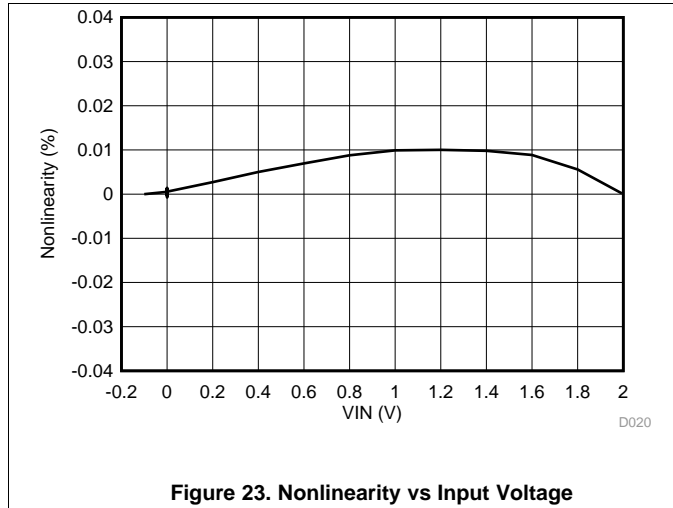

Figure 23. Nonlinearity vs Input Voltage

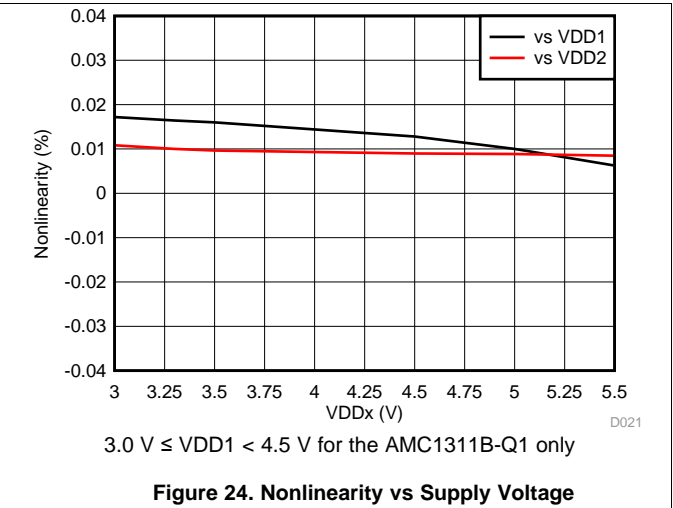

Figure 24. Nonlinearity vs Supply Voltage

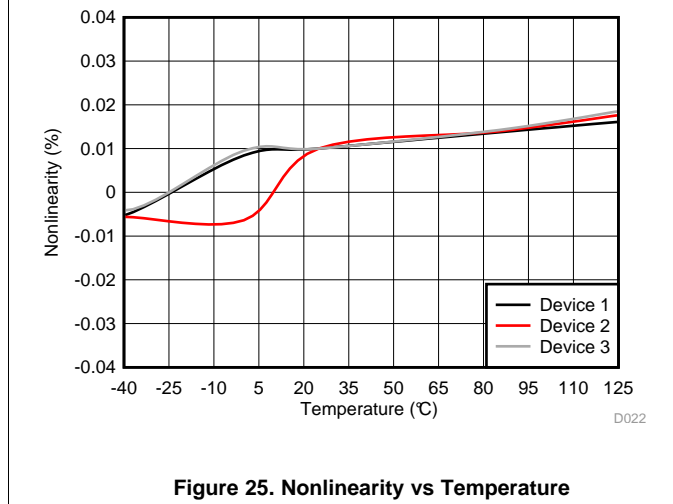

Figure 25. Nonlinearity vs Temperature

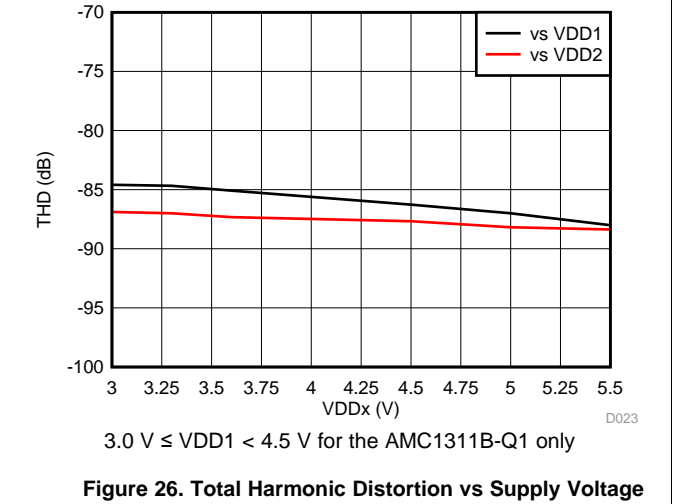

Figure 26. Total Harmonic Distortion vs Supply Voltage

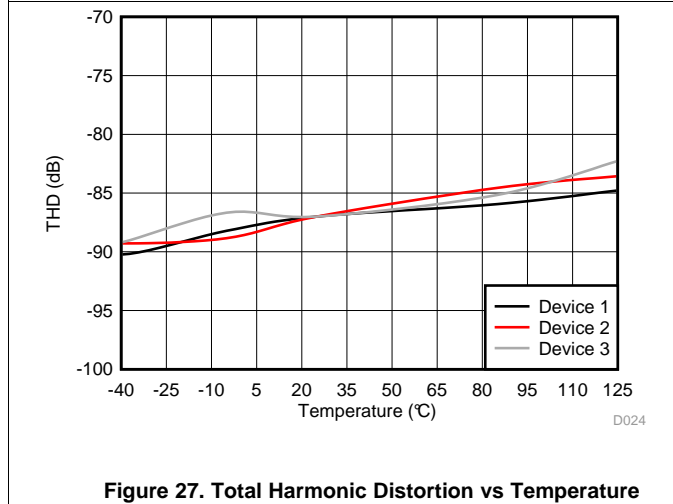

Figure 27. Total Harmonic Distortion vs Temperature

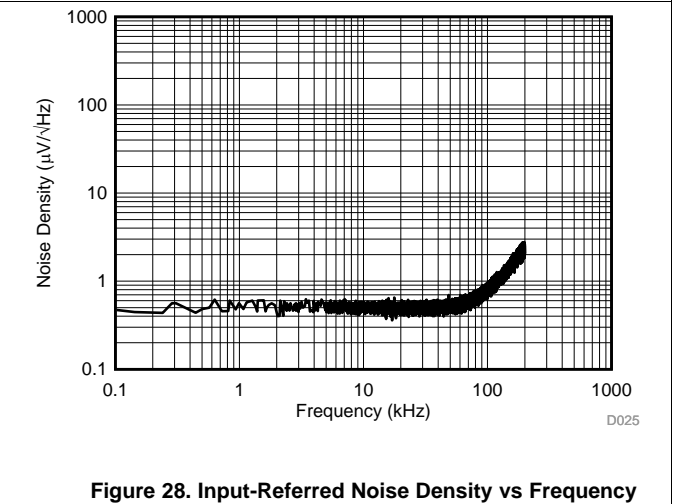

Figure 28. Input-Referred Noise Density vs Frequency

Typical Characteristics (continued)

at VDD1 = 5 V, VDD2 = 3.3 V, SHTDN = 0 V, $f_{IN} = 10$ kHz, and BW = 100 kHz (unless otherwise noted)

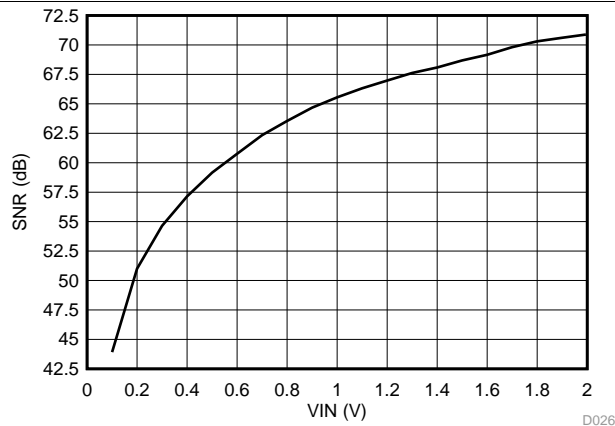
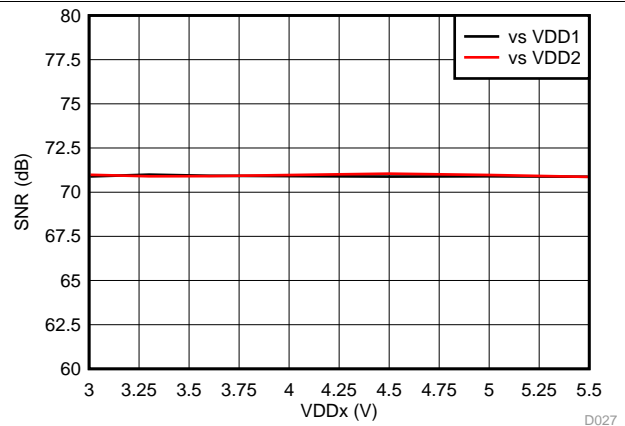

Figure 29. Signal-to-Noise Ratio vs Input Voltage



3.0 V ≤ VDD1 < 4.5 V for the AMC1311B-Q1 only

Figure 30. Signal-to-Noise Ratio vs Supply Voltage

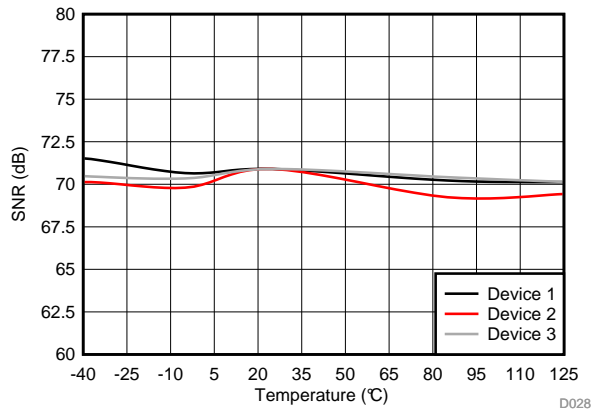

Figure 31. Signal-to-Noise Ratio vs Temperature

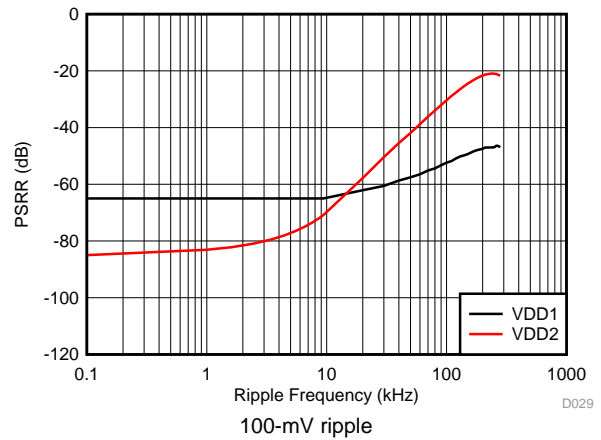

Figure 32. Power-Supply Rejection Ratio vs Ripple Frequency
100-mV ripple

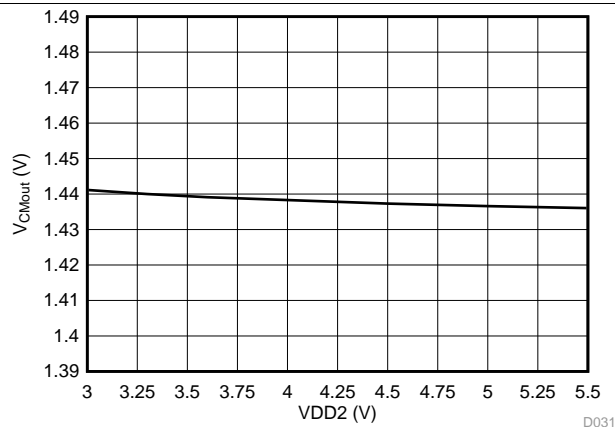

Figure 33. Output Common-Mode Voltage vs Low-Side Supply Voltage

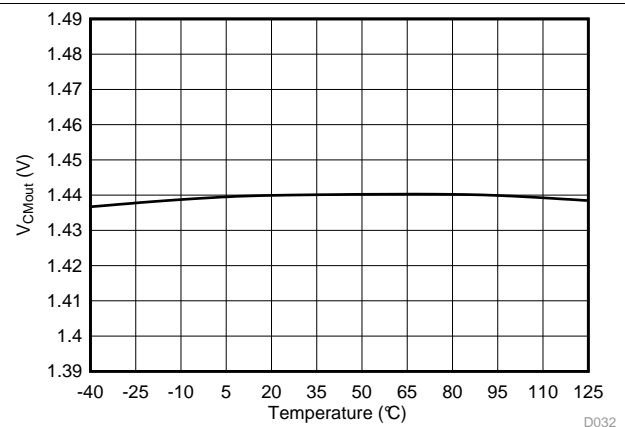

Figure 34. Output Common-Mode Voltage vs Temperature

Typical Characteristics (continued)

at VDD1 = 5 V, VDD2 = 3.3 V, SHTDN = 0 V, $f_{IN} = 10$ kHz, and BW = 100 kHz (unless otherwise noted)

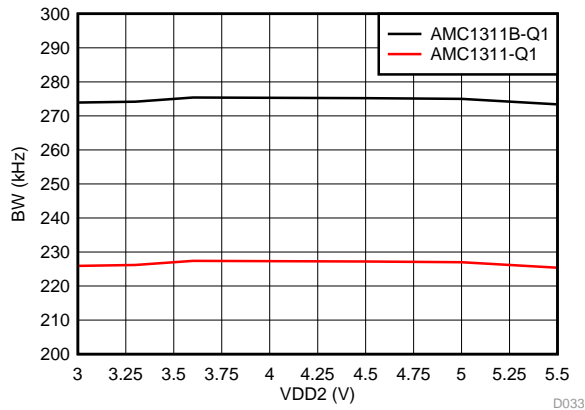

Figure 35. Output Bandwidth vs Low-Side Supply Voltage

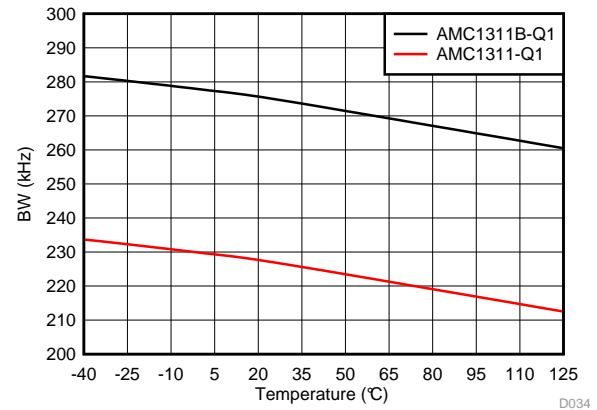
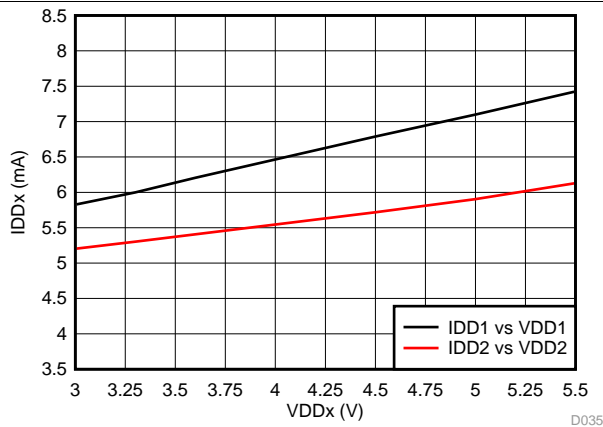

Figure 36. Output Bandwidth vs Temperature



3.0 V ≤ VDD1 < 4.5 V for the AMC1311B-Q1 only

Figure 37. Supply Current vs Supply Voltage

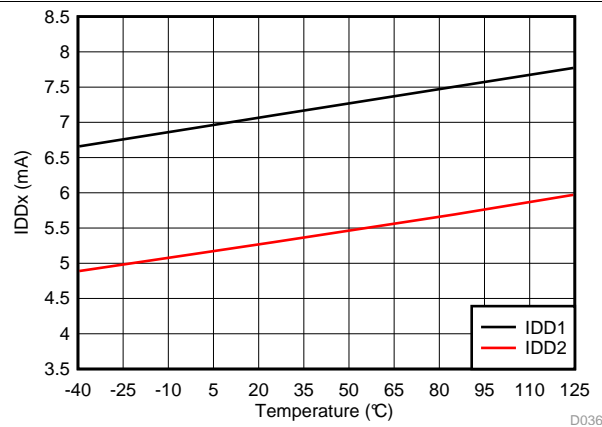

Figure 38. Supply Current vs Temperature

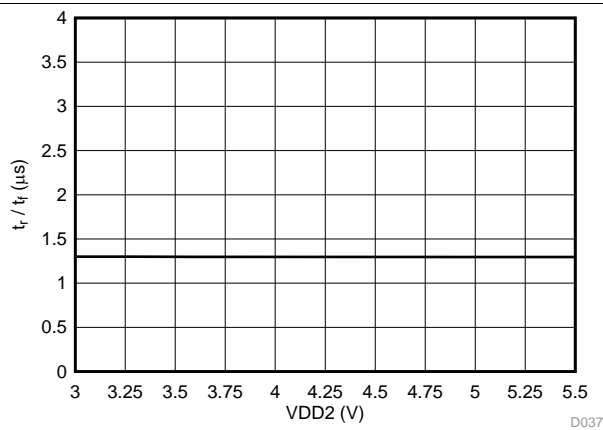

Figure 39. Output Rise and Fall Time vs Low-Side Supply Voltage

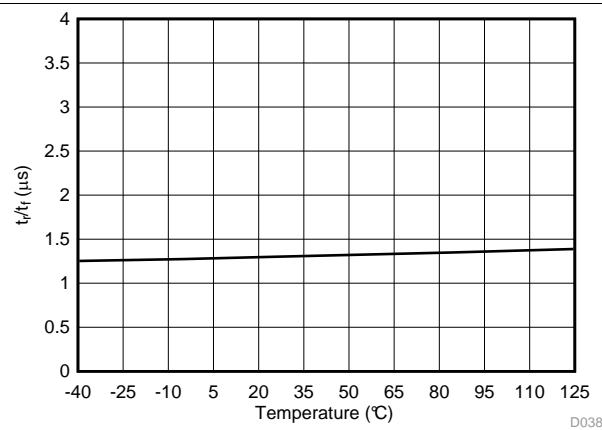
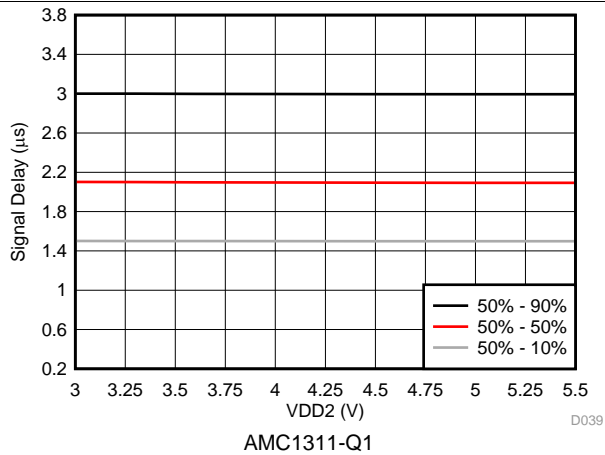
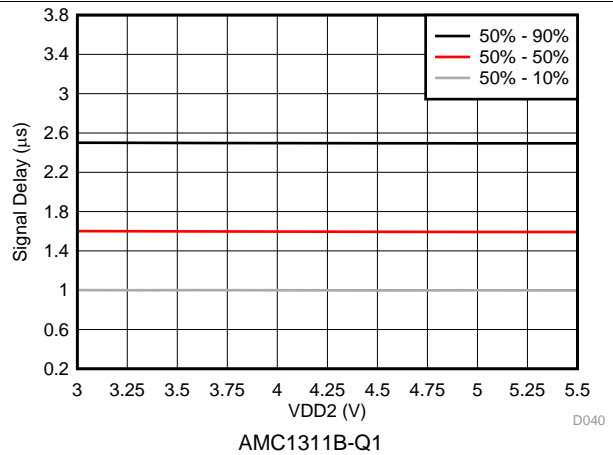
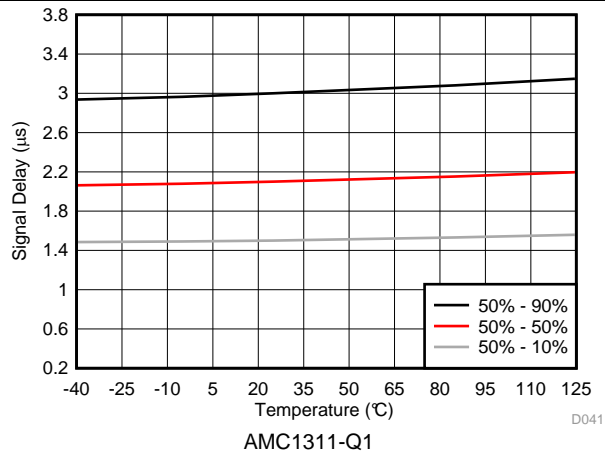
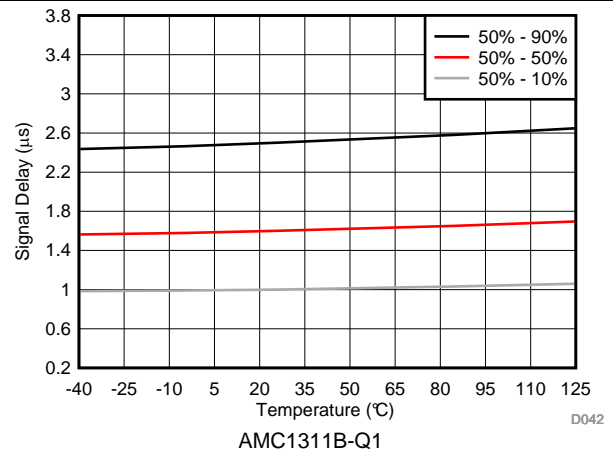

Figure 40. Output Rise and Fall Time vs Temperature

Typical Characteristics (continued)

 at VDD1 = 5 V, VDD2 = 3.3 V, SHTDN = 0 V, $f_{IN} = 10$ kHz, and BW = 100 kHz (unless otherwise noted)

Figure 41. VIN to VOUTP, VOUTN Signal Delay vs Low-Side Supply Voltage

Figure 42. VIN to VOUTP, VOUTN Signal Delay vs Low-Side Supply Voltage

Figure 43. VIN to VOUTP, VOUTN Signal Delay vs Temperature

Figure 44. VIN to VOUTP, VOUTN Signal Delay vs Temperature

8 Detailed Description

8.1 Overview

The AMC1311-Q1 is a precision, isolated amplifier with a high input-impedance and wide input-voltage range. The input stage of the device drives a second-order, delta-sigma ($\Delta\Sigma$) modulator. The modulator uses the internal voltage reference and clock generator to convert the analog input signal to a digital bitstream. The drivers (termed TX in the *Functional Block Diagram* section) transfer the output of the modulator across the isolation barrier that separates the high-side and low-side voltage domains. The received bitstream and clock are synchronized and processed by a fourth-order analog filter on the low-side and presented as a differential analog output.

The SiO₂-based, double-capacitive isolation barrier supports a high level of magnetic field immunity, as described in *ISO72x Digital Isolator Magnetic-Field Immunity*. The digital modulation used in the AMC1311-Q1 and the isolation barrier characteristics result in high reliability and common-mode transient immunity.

8.2 Functional Block Diagram

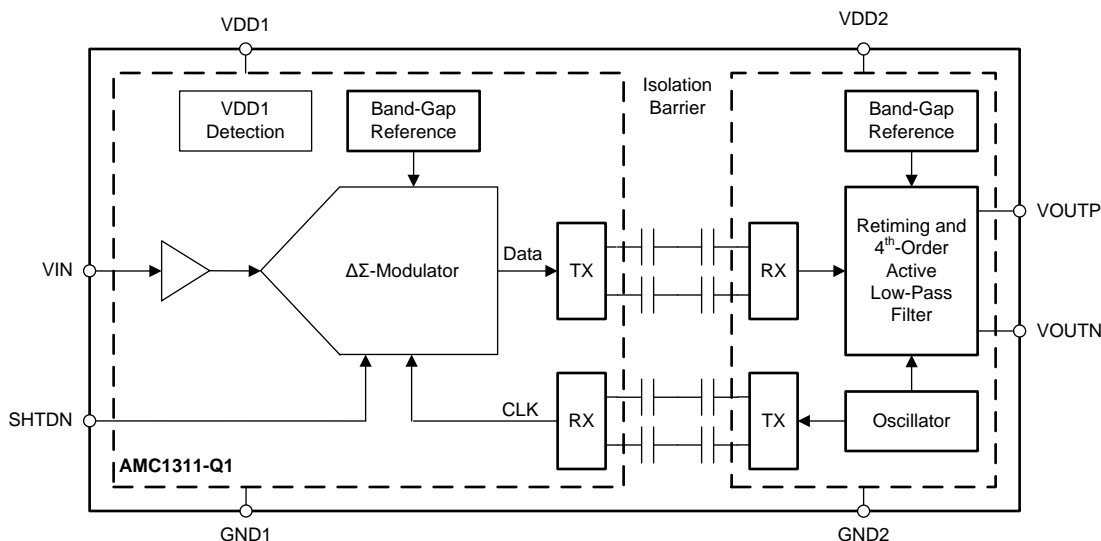

8.3 Feature Description

8.3.1 Analog Input

The input stage of the AMC1311-Q1 feeds a second-order, switched-capacitor, feed-forward $\Delta\Sigma$ modulator. The modulator converts the analog signal into a bitstream that is transferred over the isolation barrier, as described in the *Isolation Channel Signal Transmission* section. The high-impedance, and low bias-current input of the AMC1311-Q1 makes the device suitable for isolated voltage sensing applications. Figure 45 depicts the equivalent input structure of the AMC1311-Q1 with the relevant components.

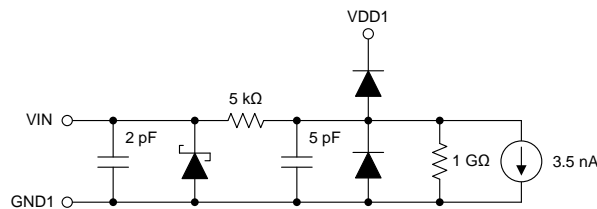

Figure 45. Equivalent Analog Input Circuit

Feature Description (continued)

There are two restrictions on the analog input signal, VIN. First, if the input voltage VIN exceeds the voltage of 6.5 V, the input current must be limited to 10 mA because the device input electrostatic discharge (ESD) protection turns on. In addition, the linearity and noise performance of the device are ensured only when the analog input voltage remains within the specified linear full-scale range (VFSR).

8.3.2 Isolation Channel Signal Transmission

The AMC1311-Q1 uses an on-off keying (OOK) modulation scheme to transmit the modulator output bitstream across the SiO₂-based isolation barrier. As shown in Figure 46, the transmitter modulates the bitstream at TX IN with an internally-generated, high-frequency carrier across the isolation barrier to represent a digital one and does not send a signal to represent the digital zero. The nominal frequency of the carrier used inside the AMC1311-Q1 is 480 MHz.

The receiver demodulates the signal after advanced signal conditioning and produces the output. The AMC1311-Q1 also incorporates advanced circuit techniques to maximize the CMTI performance and minimize the radiated emissions caused by the high-frequency carrier and IO buffer switching.

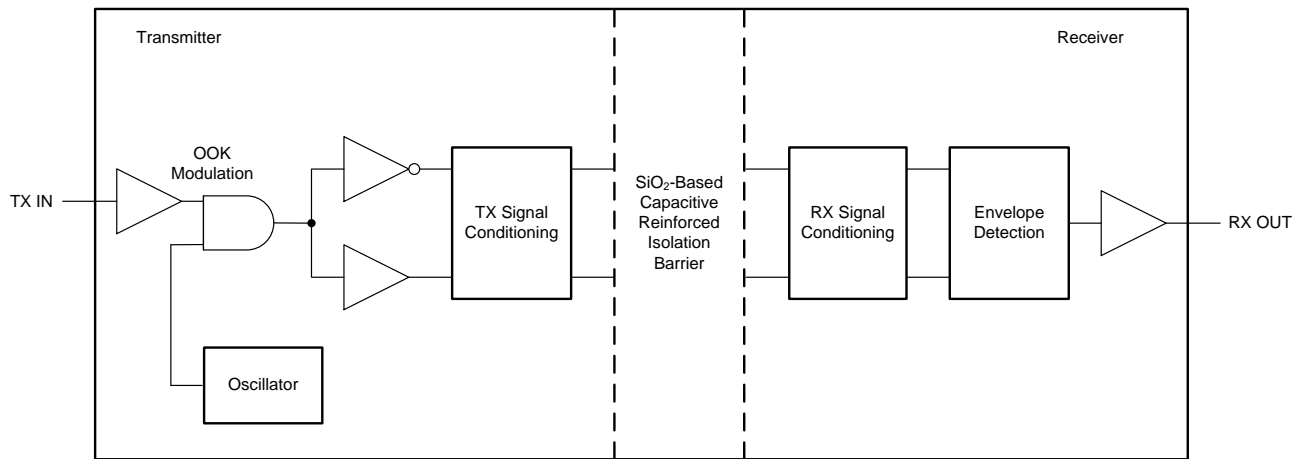

Figure 46. Block Diagram of an Isolation Channel

Figure 47 shows the concept of the OOK scheme.

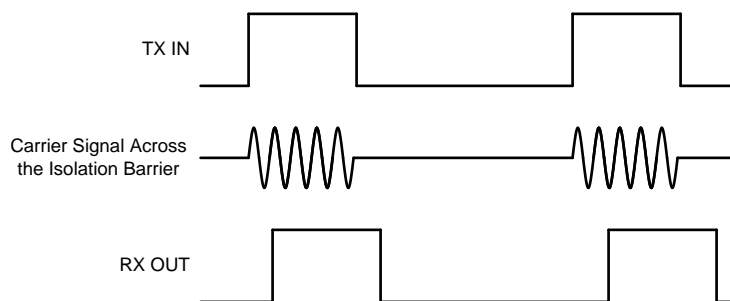

Figure 47. OOK-Based Modulation Scheme

Feature Description (continued)

8.3.3 Fail-Safe Output

The AMC1311-Q1 offers a fail-safe output that simplifies diagnostics on system level. The fail-safe output is active in three cases:

- When the high-side supply VDD1 of the AMC1311-Q1 device is missing
- When the high-side supply VDD1 falls under the $VDD1_{UV}$ undervoltage threshold level or
- When the SHTDN pin is pulled high

Figure 48 shows the fail-safe output of the AMC1311-Q1 that is a negative differential output voltage that does not occur under normal device operation. As a reference value for the fail-safe detection on a system level, use the $V_{FAILSAFE}$ voltage as specified in the *Electrical Characteristics* table.

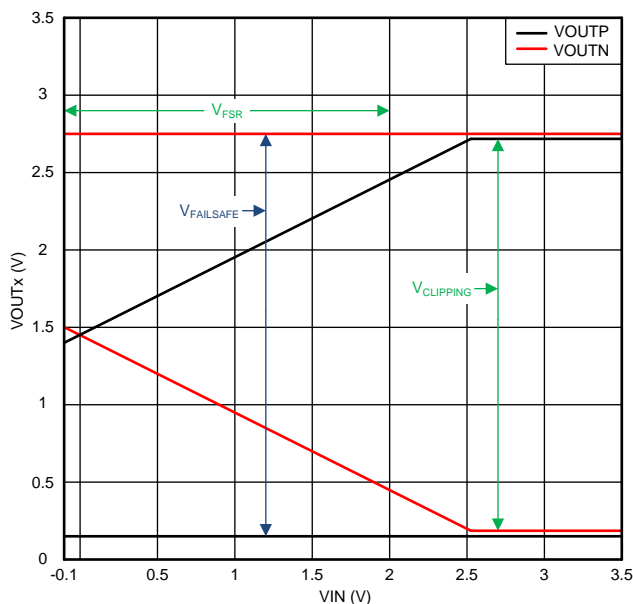

Figure 48. AMC1311-Q1 Output Behavior

8.4 Device Functional Modes

The AMC1311-Q1 is operational when the power supplies VDD1 and VDD2 are applied, as specified in the *Recommended Operating Conditions* table.

9 Application and Implementation

NOTE

Information in the following applications sections is not part of the TI component specification, and TI does not warrant its accuracy or completeness. TI's customers are responsible for determining suitability of components for their purposes. Customers should validate and test their design implementation to confirm system functionality.

9.1 Application Information

The very low input bias current, ac and dc errors, and temperature drift make the AMC1311-Q1 a high-performance solution for automotive applications where voltage measurement with high common-mode levels is required.

9.2 Typical Application

Isolated amplifiers are widely used in automotive applications such as traction inverters, on-board chargers, and dc/dc converters. The input structure of the AMC1311-Q1 is tailored for isolated voltage sensing using resistive dividers to reduce the high common-mode voltage.

Figure 49 depicts a typical use of the AMC1311-Q1 for dc bus voltage sensing in a traction inverter application. Phase current measurement is accomplished through the shunt resistors, R_{SHUNT} (in this case, two-pin shunts) and the AMC1301-Q1 isolated amplifiers that are optimized for isolated current sensing. The high-impedance input and the high common-mode transient immunity of the AMC1311-Q1 ensure reliable and accurate operation even in high-noise environments.

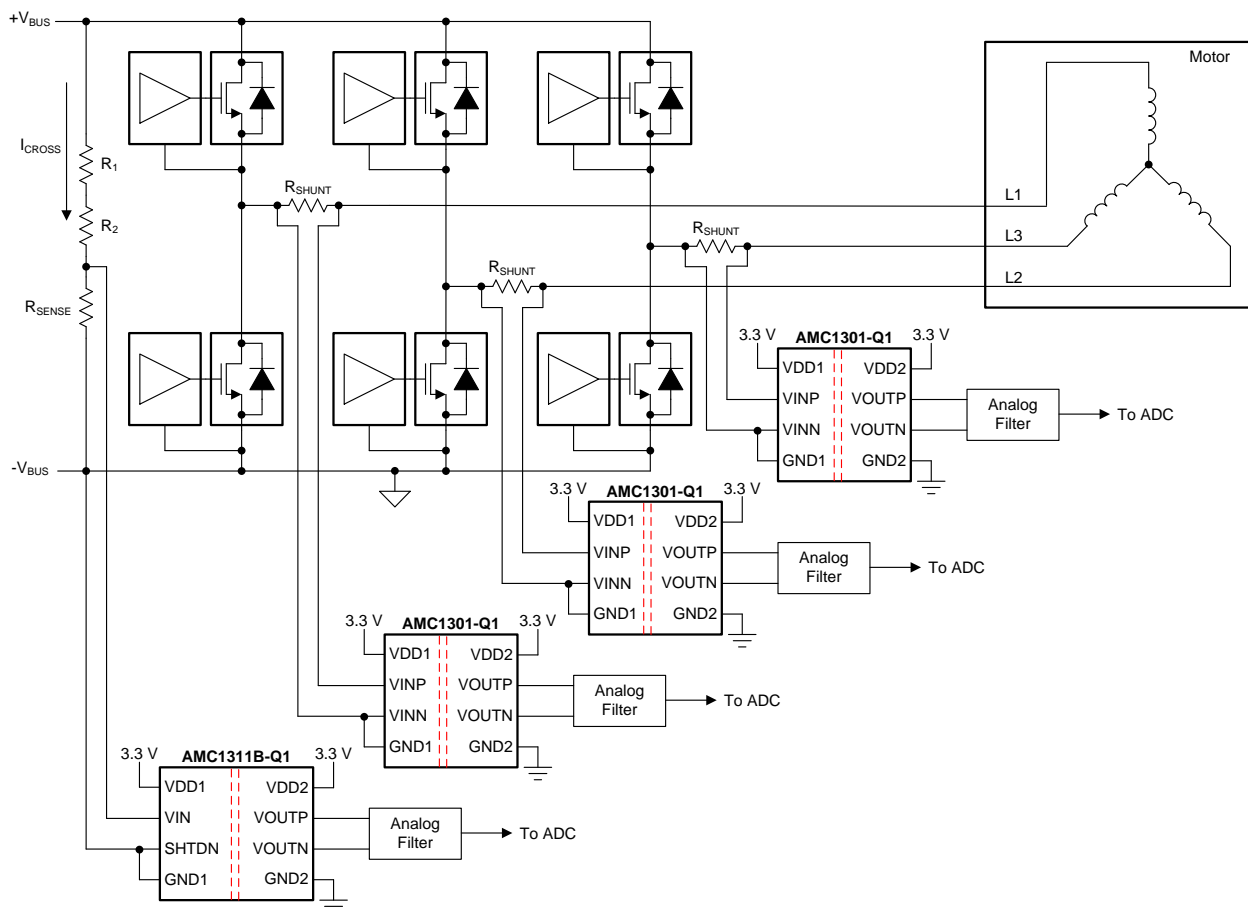

Figure 49. Using the AMC1311B-Q1 for DC Bus Voltage Sensing in Traction Inverters

Typical Application (continued)

9.2.1 Design Requirements

Table 1 lists the parameters for this typical application.

Table 1. Design Requirements

PARAMETER	VALUE
High-side supply voltage	3.3 V or 5 V
Low-side supply voltage	3.3 V or 5 V
Voltage drop across the sensing resistor for a linear response	2 V (maximum)
Current through the resistive divider, I _{CROSS}	0.1 mA (maximum)
Signal delay (50% VIN to 90% VOUTP, VOUTN)	3 μs (maximum)

9.2.2 Detailed Design Procedure

Use Ohm's Law to calculate the minimum total resistance of the resistive divider to limit the cross current to the desired value ($R_{TOTAL} = V_{BUS} / I_{CROSS}$) and the required sense resistor value to be connected to the AMC1311-Q1 input: $R_{SENSE} = V_{FSR} / I_{CROSS}$.

Consider the following two restrictions to choose the proper value of the shunt resistor R_{SENSE}:

- The voltage drop on R_{SENSE} caused by the nominal voltage range of the system must not exceed the recommended input voltage range: $V_{SENSE} \leq V_{FSR}$
- The voltage drop on R_{SENSE} caused by the maximum allowed system overvoltage must not exceed the input voltage that causes a clipping output: $V_{SENSE} \leq V_{Clipping}$

Table 2 lists examples of nominal E96-series (1% accuracy) resistor values for systems using 600 V and 800 V on the dc bus.

Table 2. Resistor Value Examples

PARAMETER	600-V DC BUS	800-V DC Bus
Resistive divider resistor R ₁	3.01 MΩ	4.22 MΩ
Resistive divider resistor R ₂	3.01 MΩ	4.22 MΩ
Sense resistor R _{SENSE}	20 kΩ	21 kΩ
Resulting current through resistive divider I _{CROSS}	99.3 μA	94.5 μA
Resulting voltage drop on sense resistor V _{SENSE}	1.987 V	1.986 V

For systems using single-ended input ADCs, Figure 50 shows an example of a TLV313-Q1-based signal conversion and filter circuit as used on the AMC1311EVM. Tailor the bandwidth of this filter stage to the bandwidth requirement of the system and use NP0-type capacitors for best performance.

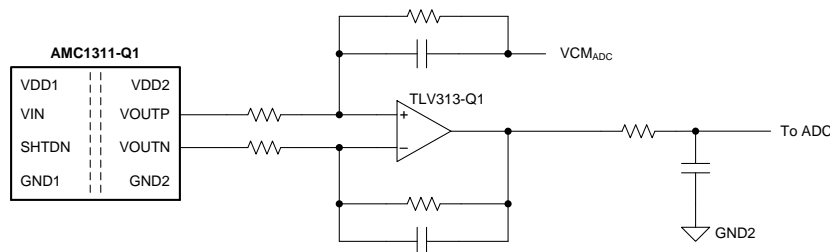

Figure 50. Connecting the AMC1311-Q1 Output to Single-Ended Input ADC

For more information on the general procedure to design the filtering and driving stages of SAR ADCs, see *18-Bit, 1MSPS Data Acquisition Block (DAQ) Optimized for Lowest Distortion and Noise* and *18-Bit Data Acquisition Block (DAQ) Optimized for Lowest Power*, available for download at www.ti.com.

9.2.3 Application Curve

In traction inverter applications, the power switches must be protected in case of an overvoltage condition. To allow for fast system power-off, a low delay caused by the isolated amplifier is required. Figure 51 shows the typical full-scale step response of the AMC1311-Q1. Consider the delay of the required window comparator and the MCU to calculate the overall response time of the system.

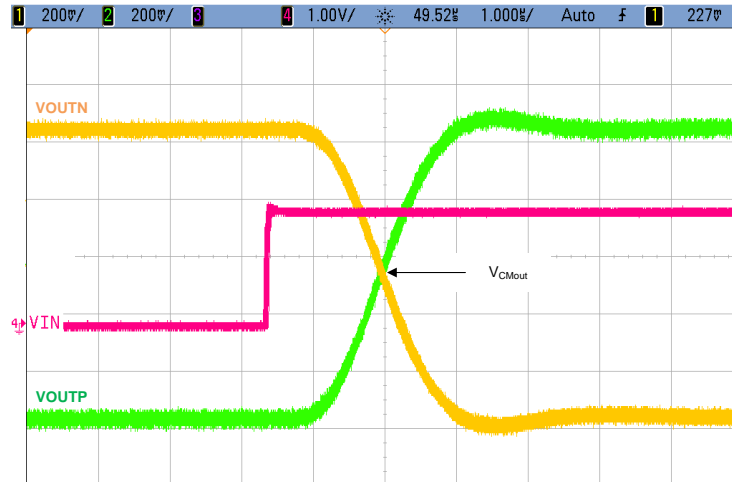

Figure 51. Step Response of the AMC1311B-Q1

9.3 Do's and Don'ts

Do not leave the analog input VIN of the AMC1311-Q1 unconnected (floating) when the device is powered up on the high-side. If the device input is left floating, the bias current may generate a negative input voltage that exceeds the specified input voltage range and the output of the device is invalid.

10 Power Supply Recommendations

In a typical traction inverter application, the high-side power supply (VDD1) for the AMC1311-Q1 is generated from the low-side supply (VDD2) of the device by an isolated dc/dc converter circuit. A low-cost solution is based on the push-pull driver [SN6501-Q1](#) and a transformer that supports the desired isolation voltage ratings. TI recommends using a low-ESR decoupling capacitor of 0.1 μF and an additional capacitor of minimum 1 μF for both supplies of the AMC1311-Q1. Place these decoupling capacitors as close as possible to the AMC1311-Q1 power-supply pins to minimize supply current loops and electromagnetic emissions.

The AMC1311-Q1 does not require any specific power up sequencing. Consider the analog settling time t_{AS} as specified in the [Switching Characteristics](#) table after ramp up of the VDD1 high-side supply.

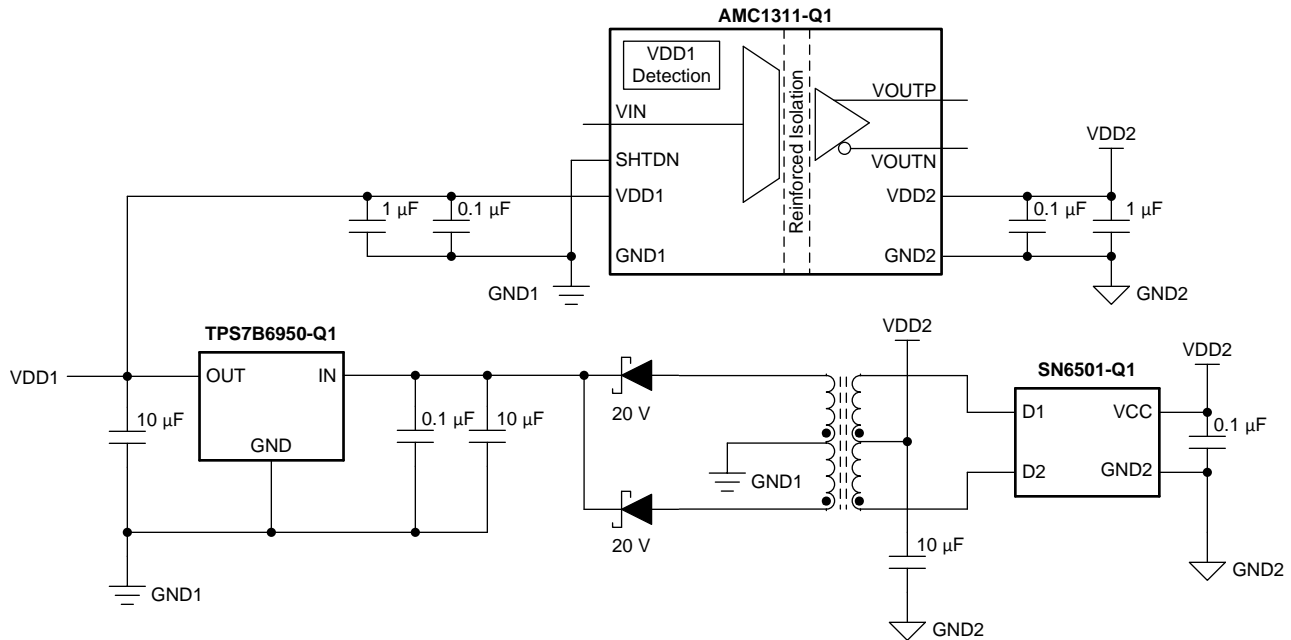

Figure 52. SN6501-Q1-Based, High-Side Power Supply

11 Layout

11.1 Layout Guidelines

For best performance, place the smaller 0.1- μ F decoupling capacitors (C1 and C6) as close as possible to the AMC1311-Q1 power-supply pins, followed by the additional C2 and C5 capacitors with a minimum value of 1 μ F. The resistors and capacitors used for the analog input (C3) and output filters (R5, R10, and C13) are placed next to the decoupling capacitors. Use 1206-size, SMD-type, ceramic decoupling capacitors and route the traces to the VIN and SHTDN pins underneath. Connect the supply voltage sources in a way that allows the supply current to flow through the pads of the decoupling capacitors before powering the AMC1311-Q1.

Figure 53 shows this approach as implemented on the AMC1311EVM. Capacitors C5 and C6 decouple the high-side supply VDD1 while capacitors C1 and C2 are used to support the low-side supply VDD2 of the AMC1311-Q1.

11.2 Layout Example

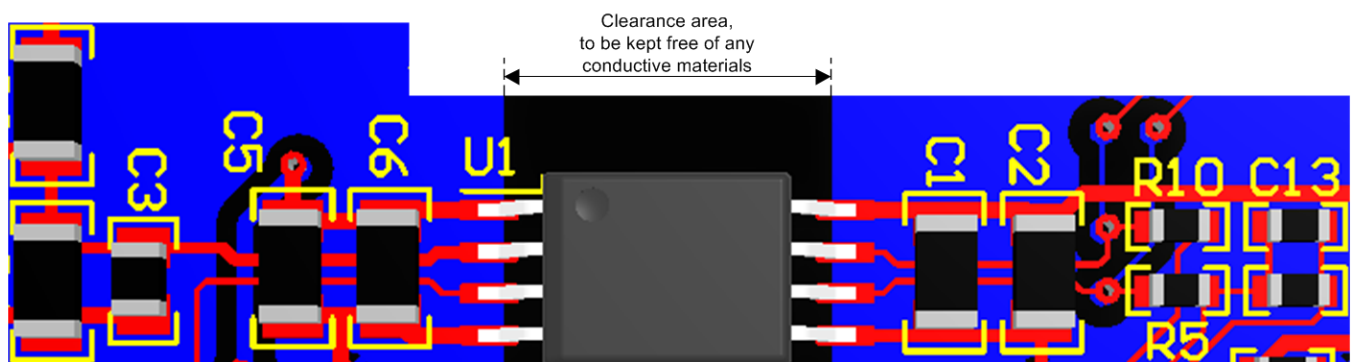

Figure 53. Recommended Layout of the AMC1311-Q1

12 Device and Documentation Support

12.1 Documentation Support

12.1.1 Receiving Notification of Documentation Updates

To receive notification of documentation updates, navigate to the device product folder on ti.com. In the upper right corner, click on *Alert me* to register and receive a weekly digest of any product information that has changed. For change details, review the revision history included in any revised document.

12.1.2 Related Documentation

For related documentation, see the following:

- [Isolation Glossary](#)
- [ADC121S101x-Q1 Single-Channel, 0.5 to 1-Msps, 12-Bit Analog-to-Digital Converter](#)
- [Semiconductor and IC Package Thermal Metrics](#)
- [ISO72x Digital Isolator Magnetic-Field Immunity](#)
- [AMC1301-Q1 Precision, \$\pm 250\$ -mV Input, 3- \$\mu\$ s Delay, Reinforced Isolated Amplifier](#)
- [TLV313-Q1 Low-Power, Rail-to-Rail In/Out, 750- \$\mu\$ V Typical Offset, 1-MHz Operational Amplifier for Cost-Sensitive Systems](#)
- [AMC1311EVM Users Guide](#)
- [18-Bit, 1-MSPS Data Acquisition Block \(DAQ\) Optimized for Lowest Distortion and Noise](#)
- [18-Bit, 1-MSPS Data Acquisition Block \(DAQ\) Optimized for Lowest Power](#)
- [SN6501-Q1 Transformer Driver for Isolated Power Supplies](#)

12.2 Receiving Notification of Documentation Updates

To receive notification of documentation updates, navigate to the device product folder on ti.com. In the upper right corner, click on *Alert me* to register and receive a weekly digest of any product information that has changed. For change details, review the revision history included in any revised document.

12.3 Community Resources

The following links connect to TI community resources. Linked contents are provided "AS IS" by the respective contributors. They do not constitute TI specifications and do not necessarily reflect TI's views; see TI's [Terms of Use](#).

TI E2E™ Online Community *TI's Engineer-to-Engineer (E2E) Community*. Created to foster collaboration among engineers. At e2e.ti.com, you can ask questions, share knowledge, explore ideas and help solve problems with fellow engineers.

Design Support *TI's Design Support* Quickly find helpful E2E forums along with design support tools and contact information for technical support.

12.4 Trademarks

E2E is a trademark of Texas Instruments.
All other trademarks are the property of their respective owners.

12.5 Electrostatic Discharge Caution



This integrated circuit can be damaged by ESD. Texas Instruments recommends that all integrated circuits be handled with appropriate precautions. Failure to observe proper handling and installation procedures can cause damage.

ESD damage can range from subtle performance degradation to complete device failure. Precision integrated circuits may be more susceptible to damage because very small parametric changes could cause the device not to meet its published specifications.

12.6 Glossary

SLYZ022 — *TI Glossary*.

This glossary lists and explains terms, acronyms, and definitions.

13 Mechanical, Packaging, and Orderable Information

The following pages include mechanical, packaging, and orderable information. This information is the most current data available for the designated devices. This data is subject to change without notice and revision of this document. For browser-based versions of this data sheet, refer to the left-hand navigation.

PACKAGING INFORMATION

Orderable Device	Status (1)	Package Type	Package Drawing	Pins	Package Qty	Eco Plan (2)	Lead/Ball Finish (6)	MSL Peak Temp (3)	Op Temp (°C)	Device Marking (4/5)	Samples
AMC1311BQDWVQ1	ACTIVE	SOIC	DWV	8	64	Green (RoHS & no Sb/Br)	NIPDAU	Level-3-260C-168 HR	-40 to 125	1311BQ1	Samples
AMC1311BQDWVRQ1	ACTIVE	SOIC	DWV	8	1000	Green (RoHS & no Sb/Br)	NIPDAU	Level-3-260C-168 HR	-40 to 125	1311BQ1	Samples
AMC1311QDWVQ1	ACTIVE	SOIC	DWV	8	64	Green (RoHS & no Sb/Br)	NIPDAU	Level-3-260C-168 HR	-40 to 125	1311Q1	Samples
AMC1311QDWVRQ1	ACTIVE	SOIC	DWV	8	1000	Green (RoHS & no Sb/Br)	NIPDAU	Level-3-260C-168 HR	-40 to 125	1311Q1	Samples

(1) The marketing status values are defined as follows:

ACTIVE: Product device recommended for new designs.

LIFEBUY: TI has announced that the device will be discontinued, and a lifetime-buy period is in effect.

NRND: Not recommended for new designs. Device is in production to support existing customers, but TI does not recommend using this part in a new design.

PREVIEW: Device has been announced but is not in production. Samples may or may not be available.

OBSELETE: TI has discontinued the production of the device.

(2) **RoHS:** TI defines "RoHS" to mean semiconductor products that are compliant with the current EU RoHS requirements for all 10 RoHS substances, including the requirement that RoHS substance do not exceed 0.1% by weight in homogeneous materials. Where designed to be soldered at high temperatures, "RoHS" products are suitable for use in specified lead-free processes. TI may reference these types of products as "Pb-Free".

RoHS Exempt: TI defines "RoHS Exempt" to mean products that contain lead but are compliant with EU RoHS pursuant to a specific EU RoHS exemption.

Green: TI defines "Green" to mean the content of Chlorine (Cl) and Bromine (Br) based flame retardants meet JS709B low halogen requirements of <=1000ppm threshold. Antimony trioxide based flame retardants must also meet the <=1000ppm threshold requirement.

(3) MSL, Peak Temp. - The Moisture Sensitivity Level rating according to the JEDEC industry standard classifications, and peak solder temperature.

(4) There may be additional marking, which relates to the logo, the lot trace code information, or the environmental category on the device.

(5) Multiple Device Markings will be inside parentheses. Only one Device Marking contained in parentheses and separated by a "-" will appear on a device. If a line is indented then it is a continuation of the previous line and the two combined represent the entire Device Marking for that device.

(6) Lead/Ball Finish - Orderable Devices may have multiple material finish options. Finish options are separated by a vertical ruled line. Lead/Ball Finish values may wrap to two lines if the finish value exceeds the maximum column width.

Important Information and Disclaimer:The information provided on this page represents TI's knowledge and belief as of the date that it is provided. TI bases its knowledge and belief on information provided by third parties, and makes no representation or warranty as to the accuracy of such information. Efforts are underway to better integrate information from third parties. TI has taken and

continues to take reasonable steps to provide representative and accurate information but may not have conducted destructive testing or chemical analysis on incoming materials and chemicals. TI and TI suppliers consider certain information to be proprietary, and thus CAS numbers and other limited information may not be available for release.

In no event shall TI's liability arising out of such information exceed the total purchase price of the TI part(s) at issue in this document sold by TI to Customer on an annual basis.

OTHER QUALIFIED VERSIONS OF AMC1311-Q1 :

- Catalog: [AMC1311](#)

NOTE: Qualified Version Definitions:

- Catalog - TI's standard catalog product

TAPE AND REEL INFORMATION

QUADRANT ASSIGNMENTS FOR PIN 1 ORIENTATION IN TAPE

*All dimensions are nominal

Device	Package Type	Package Drawing	Pins	SPQ	Reel Diameter (mm)	Reel Width W1 (mm)	A0 (mm)	B0 (mm)	K0 (mm)	P1 (mm)	W (mm)	Pin1 Quadrant
AMC1311BQDWVRQ1	SOIC	DWV	8	1000	330.0	16.4	12.05	6.15	3.3	16.0	16.0	Q1
AMC1311QDWVRQ1	SOIC	DWV	8	1000	330.0	16.4	12.05	6.15	3.3	16.0	16.0	Q1

TAPE AND REEL BOX DIMENSIONS

*All dimensions are nominal

Device	Package Type	Package Drawing	Pins	SPQ	Length (mm)	Width (mm)	Height (mm)
AMC1311BQDWVRQ1	SOIC	DWV	8	1000	350.0	350.0	43.0
AMC1311QDWVRQ1	SOIC	DWV	8	1000	350.0	350.0	43.0



DWV0008A

SOIC - 2.8 mm max height

SOIC

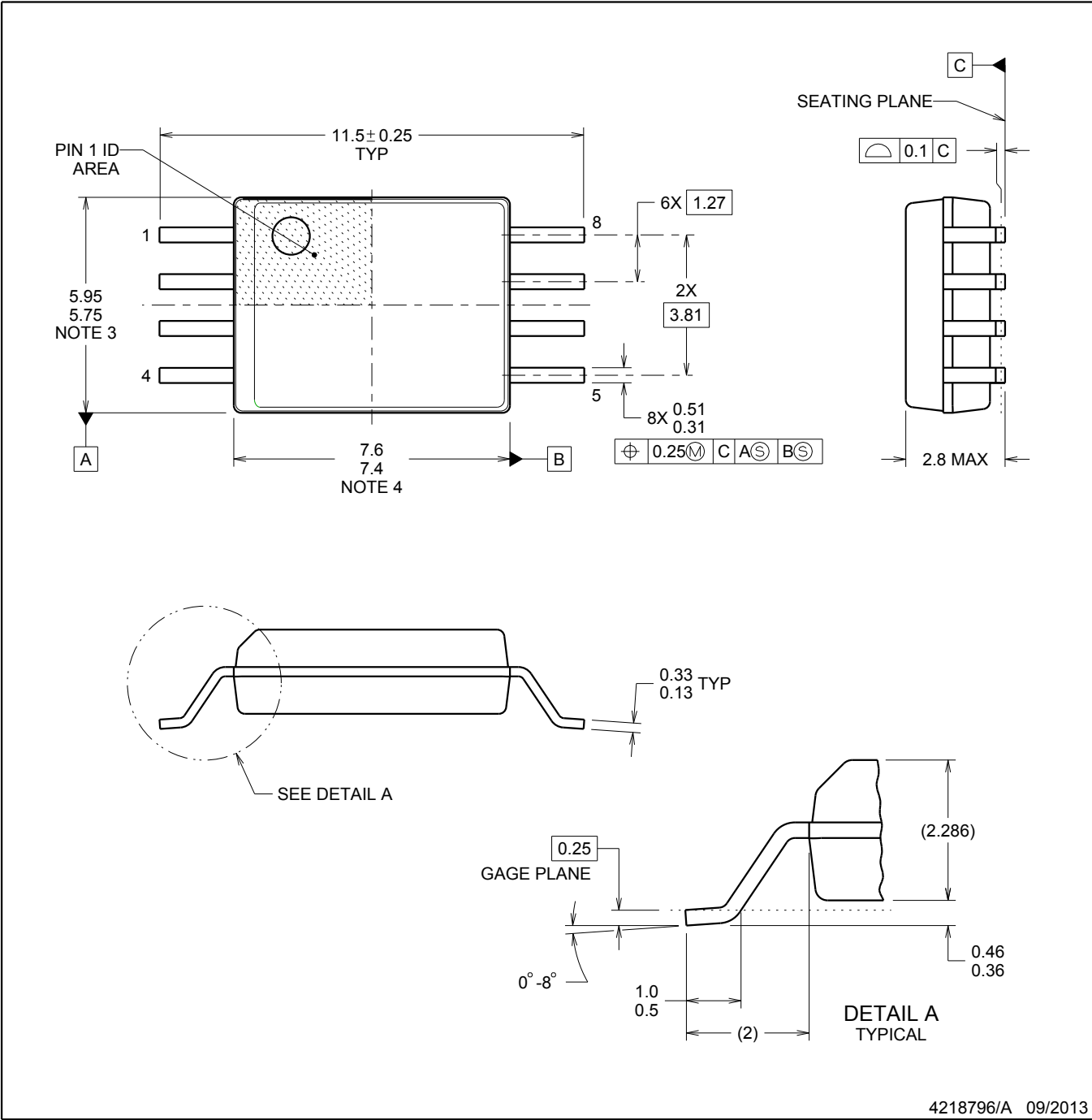

4218796/A 09/2013

NOTES:

1. All linear dimensions are in millimeters. Dimensions in parenthesis are for reference only. Dimensioning and tolerancing per ASME Y14.5M.
2. This drawing is subject to change without notice.
3. This dimension does not include mold flash, protrusions, or gate burrs. Mold flash, protrusions, or gate burrs shall not exceed 0.15 mm, per side.
4. This dimension does not include interlead flash. Interlead flash shall not exceed 0.25 mm, per side.



LAND PATTERN EXAMPLE
 9.1 mm NOMINAL CLEARANCE/CREEPAGE
 SCALE:6X

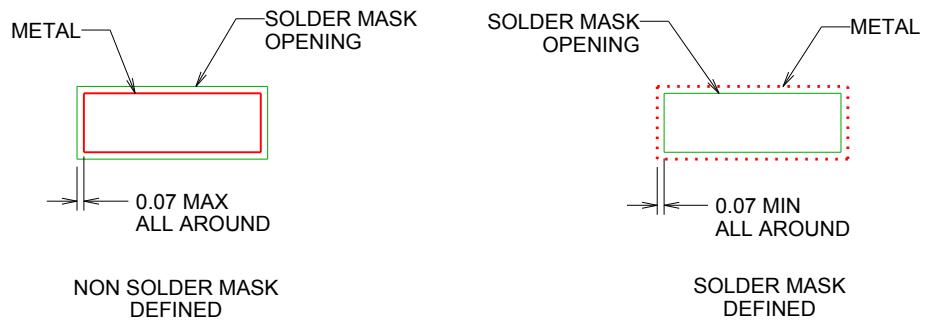

SOLDER MASK DETAILS

4218796/A 09/2013

NOTES: (continued)

- 5. Publication IPC-7351 may have alternate designs.
- 6. Solder mask tolerances between and around signal pads can vary based on board fabrication site.

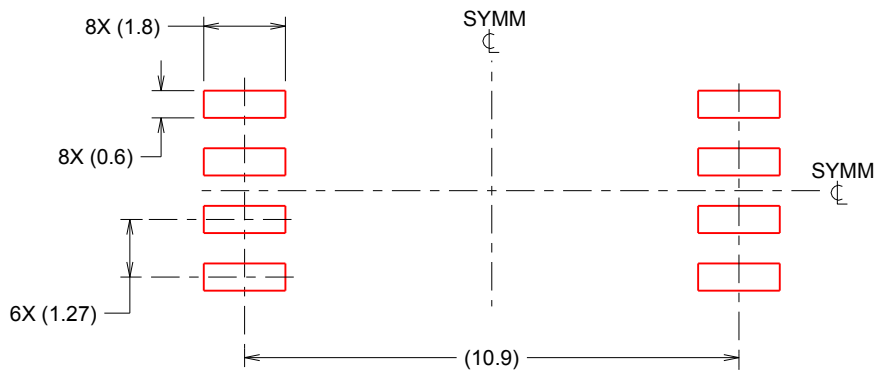

SOLDER PASTE EXAMPLE
 BASED ON 0.125 mm THICK STENCIL
 SCALE:6X

4218796/A 09/2013

NOTES: (continued)

- 7. Laser cutting apertures with trapezoidal walls and rounded corners may offer better paste release. IPC-7525 may have alternate design recommendations.
- 8. Board assembly site may have different recommendations for stencil design.

IMPORTANT NOTICE AND DISCLAIMER

TI PROVIDES TECHNICAL AND RELIABILITY DATA (INCLUDING DATASHEETS), DESIGN RESOURCES (INCLUDING REFERENCE DESIGNS), APPLICATION OR OTHER DESIGN ADVICE, WEB TOOLS, SAFETY INFORMATION, AND OTHER RESOURCES "AS IS" AND WITH ALL FAULTS, AND DISCLAIMS ALL WARRANTIES, EXPRESS AND IMPLIED, INCLUDING WITHOUT LIMITATION ANY IMPLIED WARRANTIES OF MERCHANTABILITY, FITNESS FOR A PARTICULAR PURPOSE OR NON-INFRINGEMENT OF THIRD PARTY INTELLECTUAL PROPERTY RIGHTS.

These resources are intended for skilled developers designing with TI products. You are solely responsible for (1) selecting the appropriate TI products for your application, (2) designing, validating and testing your application, and (3) ensuring your application meets applicable standards, and any other safety, security, or other requirements. These resources are subject to change without notice. TI grants you permission to use these resources only for development of an application that uses the TI products described in the resource. Other reproduction and display of these resources is prohibited. No license is granted to any other TI intellectual property right or to any third party intellectual property right. TI disclaims responsibility for, and you will fully indemnify TI and its representatives against, any claims, damages, costs, losses, and liabilities arising out of your use of these resources.

TI's products are provided subject to TI's Terms of Sale (www.ti.com/legal/termsofsale.html) or other applicable terms available either on ti.com or provided in conjunction with such TI products. TI's provision of these resources does not expand or otherwise alter TI's applicable warranties or warranty disclaimers for TI products.

Mailing Address: Texas Instruments, Post Office Box 655303, Dallas, Texas 75265
Copyright © 2020, Texas Instruments Incorporated