

## Features

- ◆ Operating voltage: 5.5V
- ◆ Low Input Capacitance: 35pF
- ◆ Complies with following standards:
  - IEC 61000-4-2 (ESD) immunity test
    - Air discharge: ±30kV
    - Contact discharge: ±30kV
  - IEC61000-4-4 (EFT) 40A (5/50ns)
- ◆ RoHS Compliant

## Mechanical Characteristics

- ◆ Package: SOT23-6
- ◆ Lead Finish: Matte Tin
- ◆ Case Material: “Green” Molding Compound.
- ◆ UL Flammability Classification Rating 94V-0
- ◆ Moisture Sensitivity: Level 3 per J-STD-020



## Applications

- ◆ Mobile phone handsets
- ◆ Personal Digital Assistants (PDA)
- ◆ Portable handheld equipment (Laptop, Palmtop computers)
- ◆ Computer port, keyboard (USB1.1)

## Ordering Information

Part Number	Qty per Reel	Reel Size
TPE05H5S6	3000	7"

## Dimensions and Pin Configuration

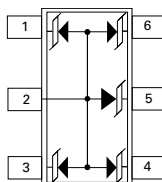

**Absolute Maximum Ratings** (Tamb=25°C unless otherwise specified)

Parameter	Symbol	Value	Unit
ESD per IEC 61000-4-2 (Air)	VESD	±30	kV
ESD per IEC 61000-4-2 (Contact)		±30	
Operating Temperature Range	TJ	-55 to +125	°C
Storage Temperature Range	Tstg	-55 to +150	°C

**Electrical Characteristics** (TA=25°C unless otherwise specified)

Symbol	Parameter
I <sub>PP</sub>	Maximum Reverse Peak Pulse Current
V <sub>C</sub>	Clamping Voltage @ I <sub>PP</sub>
V <sub>RWM</sub>	Working Peak Reverse Voltage
I <sub>R</sub>	Maximum Reverse Leakage Current @ V <sub>RWM</sub>
V <sub>BR</sub>	Breakdown Voltage @ I <sub>T</sub>
I <sub>T</sub>	Test Current
I <sub>F</sub>	Forward Current
V <sub>F</sub>	Forward Voltage @ I <sub>F</sub>
P <sub>pk</sub>	Peak Power Dissipation
C	Capacitance @ V <sub>R</sub> = 0 and f = 1.0 MHz

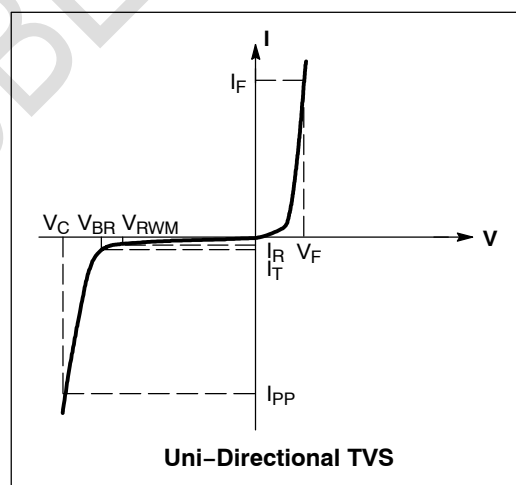

Parameter	Symbol	Min	Typ	Max	Unit	Test Condition
Reverse Working Voltage	V <sub>RWM</sub>			5.5	V	Any I/O pin to ground
Punch-Through Voltage	V <sub>BR</sub>	6			V	I <sub>T</sub> = 1mA, any I/O pin to ground
Reverse Leakage Current	I <sub>R</sub>			1	μA	V <sub>RWM</sub> = 5V, any I/O pin to ground
Clamping Voltage	V <sub>C</sub>			15	V	I <sub>PP</sub> = 1A (8 x 20μs pulse), any I/O pin to ground
Junction Capacitance	C <sub>J</sub>			35	pF	V <sub>R</sub> =0, f=1MHz, between I/O pins

**PROTECTION PRODUCTS**  
Typical characteristics

**Fig1. 8/20μs Pulse Waveform**

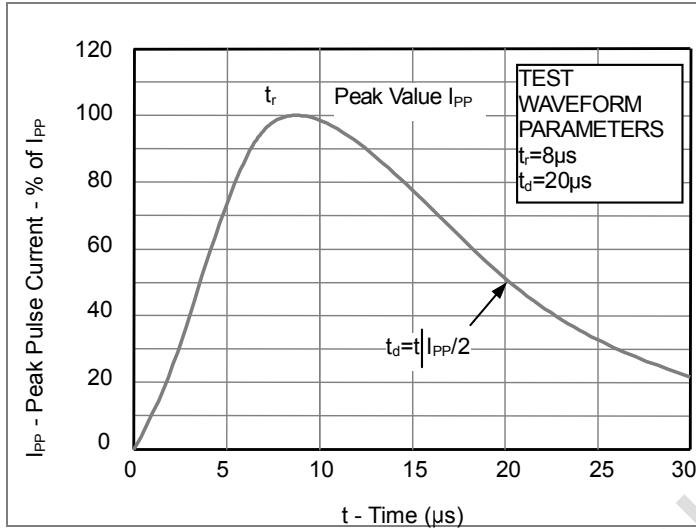

**Fig2. ESD Pulse Waveform (according to IEC 61000-4-2)**

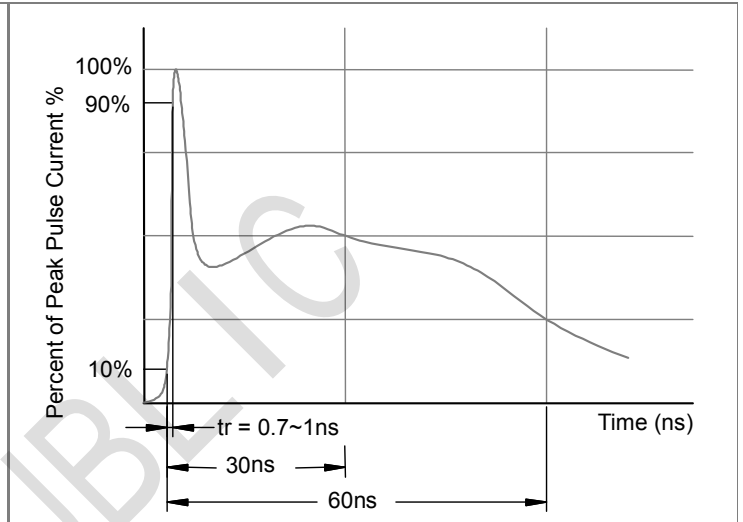

**Fig3. Power Derating Curve**

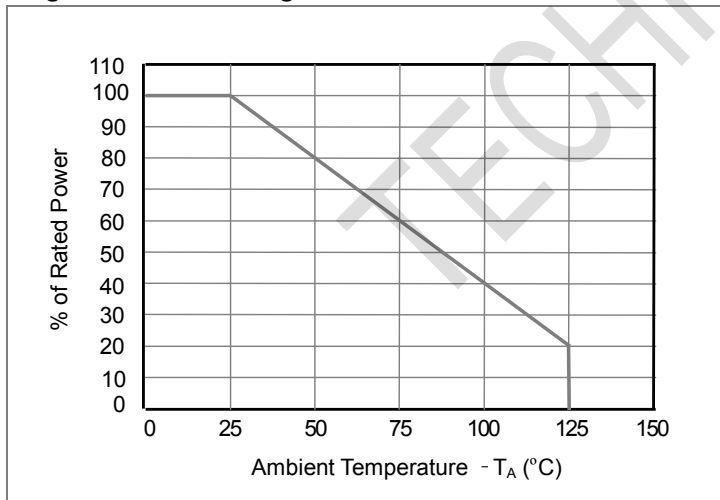

**Outline Drawing - SOT23-6**

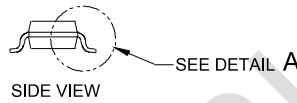
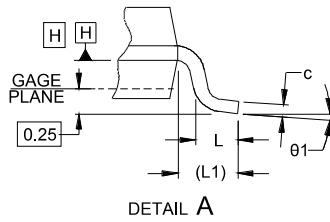
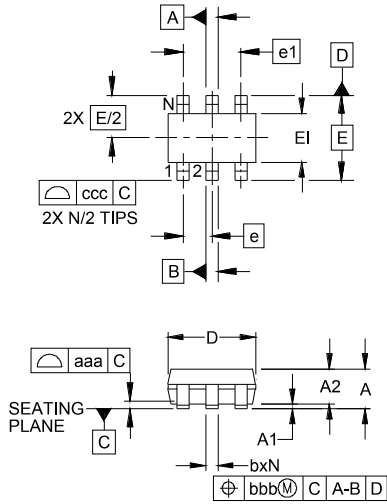

DIM	INCHES			MILLIMETERS		
	MIN	NOM	MAX	MIN	NOM	MAX
A	.035	-	.057	0.90	-	1.45
A1	.000	-	.006	0.00	-	0.15
A2	.035	.045	.051	.90	1.15	1.30
b	.010	-	.020	0.25	-	0.50
c	.003	-	.009	0.08	-	0.22
D	.110	.114	.118	2.80	2.90	3.00
E1	.060	.063	.069	1.50	1.60	1.75
E	.110 BSC			2.80 BSC		
e	.037 BSC			0.95 BSC		
e1	.075 BSC			1.90 BSC		
L	.012	.018	.024	0.30	0.45	0.60
L1	(0.024)			(0.60)		
N	6			6		
theta1	0°	-	10°	0°	-	10°
aaa	.004			0.10		
bbb	.008			0.20		
ccc	.008			0.20		

**Land Pattern - SOT23-6**

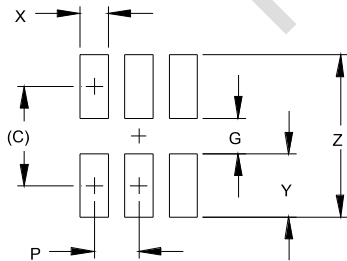

DIMENSIONS		
DIM	INCHES	MILLIMETERS
C	(.098)	(2.50)
G	.055	1.40
P	.037	0.95
X	.024	0.60
Y	.043	1.10
Z	.141	3.60