

Features

- Low forward voltage
- Reverse voltage $V_R \leq 100$ V
- Low capacitance
- High-speed switching
- Very small and flat lead SMD plastic package

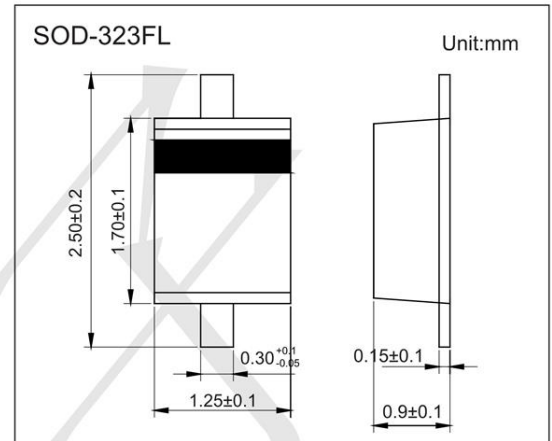

■ Absolute Maximum Ratings $T_a = 25^\circ\text{C}$

Parameter	Symbol	Rating	Unit
Reverse Voltage	V_{RM}	100	V
Forward Current	I_F	250	mA
Non-Repetitive Peak Forward Current	I_{FSM}	2.5	A
Power Dissipation (Note.1)	P_d	400	mW
(Note.2)		715	
Thermal Resistance Junction to Ambient (Note.1)	$R_{\theta JA}$	310	$^\circ\text{C}/\text{W}$
(Note.2)		175	
Thermal Resistance Junction to Solder Point	$R_{\theta JSP}$	35	
Junction Temperature	T_J	150	$^\circ\text{C}$
Storage Temperature range	T_{stg}	-65 to 150	

Note.1: Device mounted on an FR4 Printed-Circuit Board (PCB), single-sided copper, tin-plated and standard footprint.

Note.2: Device mounted on an FR4 PCB, single-sided copper, tin-plated, mounting pad for cathode 1 cm^3

■ Electrical Characteristics Ta = 25°C

Parameter	Symbol	Test Conditions	Min	Typ	Max	Unit
Reverse breakdown voltage	V _R	I _R = 100 uA	100			V
Forward voltage	V _F	I _F = 0.1 mA			200	mV
		I _F = 10 mA			350	
		I _F = 10 mA , T _J = -40°C			470	
		I _F = 50 mA			475	
		I _F = 50 mA , T _J = -40°C			560	
		I _F = 250 mA			850	
Reverse voltage leakage current	I _R	V _R = 1.5 V			0.5	uA
		V _R = 1.5 V , T _J = 60°C			12	
		V _R = 10 V			0.8	
		V _R = 10 V , T _J = 60°C			20	
		V _R = 50 V			2	
		V _R = 50 V , T _J = 60°C			44	
		V _R = 75 V			4	
		V _R = 75 V , T _J = 60°C			80	
		V _R = 100 V			9	
		V _R = 100 V , T _J = 60°C			120	
		V _R = 100 V , T _J = 85°C			600	
Junction capacitance	C _j	V _R = 0 V, f= 1 MHz			39	pF
		V _R = 1 V, f= 1 MHz			21	
Reverse recovery time	t _{rr}	I _F =I _R =10mA, I _{rr} =0.1xI _R , R _L =100Ω			5.9	ns

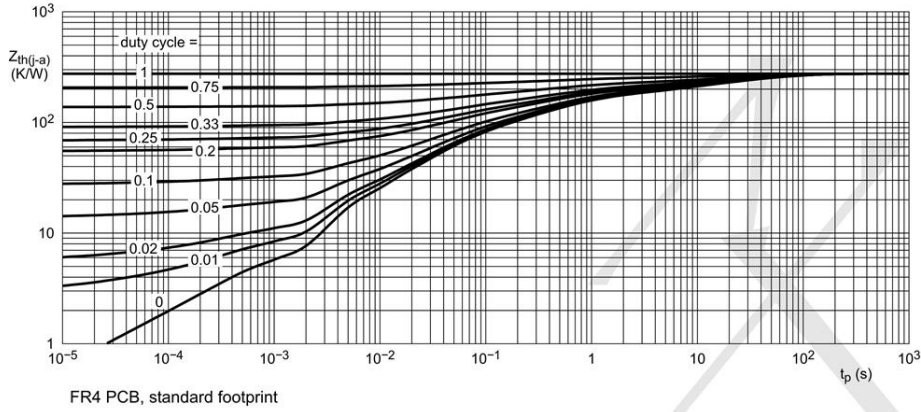

Fig 1. Transient thermal impedance from junction to ambient as a function of pulse duration; typical values

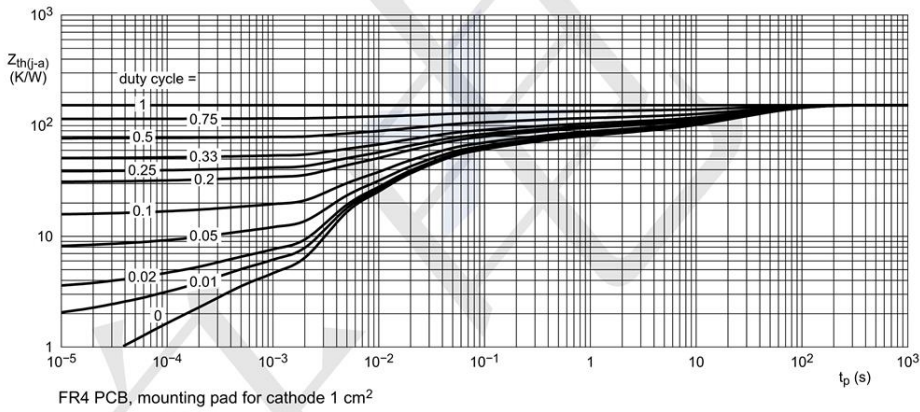
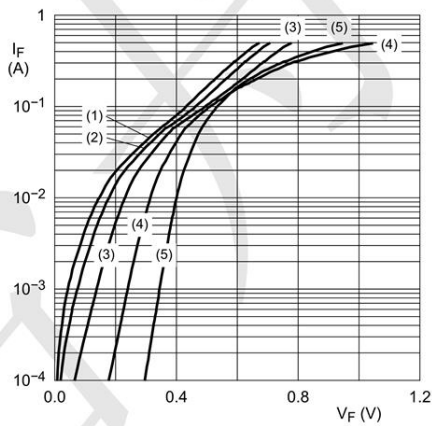
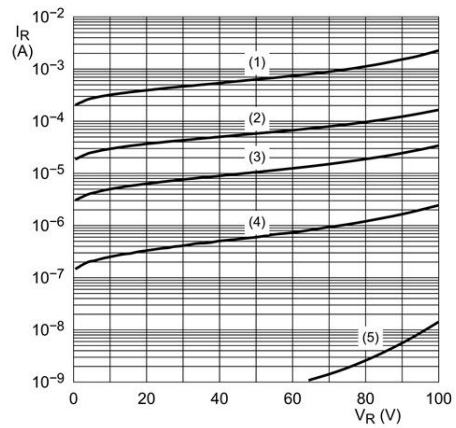

Fig 2. Transient thermal impedance from junction to ambient as a function of pulse duration; typical values



- (1) $T_{amb} = 150\text{ }^{\circ}\text{C}$ (4) $T_{amb} = 25\text{ }^{\circ}\text{C}$
- (2) $T_{amb} = 125\text{ }^{\circ}\text{C}$ (5) $T_{amb} = -40\text{ }^{\circ}\text{C}$
- (3) $T_{amb} = 85\text{ }^{\circ}\text{C}$

Fig 3. Forward current as a function of forward voltage; typical values



- (1) $T_{amb} = 125\text{ }^{\circ}\text{C}$ (4) $T_{amb} = 25\text{ }^{\circ}\text{C}$
- (2) $T_{amb} = 85\text{ }^{\circ}\text{C}$ (5) $T_{amb} = -40\text{ }^{\circ}\text{C}$
- (3) $T_{amb} = 60\text{ }^{\circ}\text{C}$

Fig 4. Reverse current as a function of reverse voltage; typical values

■ Typical Characteristics

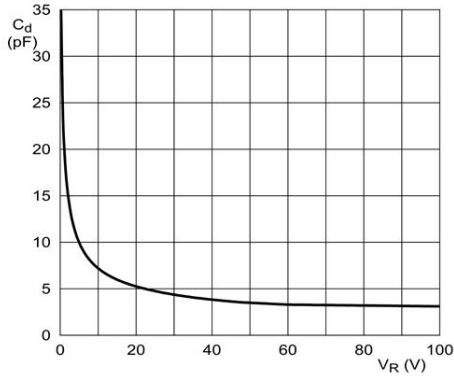

f = 1 MHz; T_{amb} = 25 °C

Fig 5. Diode capacitance as a function of reverse voltage; typical values

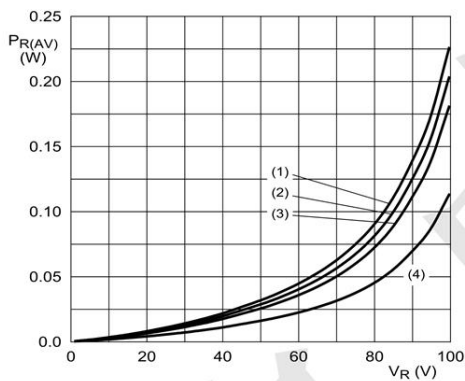

T_j = 125 °C

(1) δ = 1 (3) δ = 0.8
(2) δ = 0.9 (4) δ = 0.5

Fig 6. Average reverse power dissipation as a function of reverse voltage; typical values

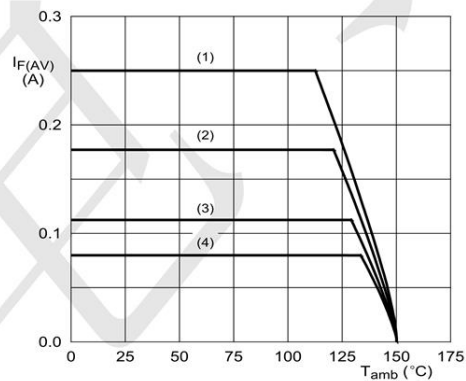

FR4 PCB, standard footprint

T_j = 150 °C

(1) δ = 1; DC (3) δ = 0.2; f = 20 kHz
(2) δ = 0.5; f = 20 kHz (4) δ = 0.1; f = 20 kHz

Fig 7. Average forward current as a function of ambient temperature; typical values

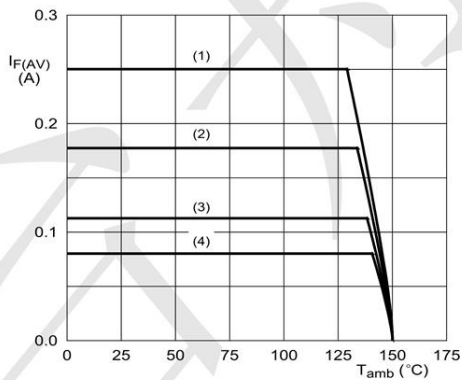

FR4 PCB, mounting pad for cathode 1 cm²

T_j = 150 °C

(1) δ = 1; DC (3) δ = 0.2; f = 20 kHz
(2) δ = 0.5; f = 20 kHz (4) δ = 0.1; f = 20 kHz

Fig 8. Average forward current as a function of ambient temperature; typical values

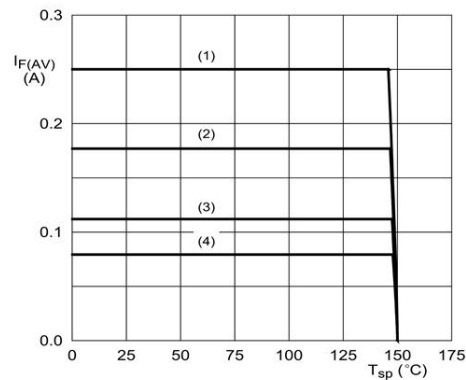

T_j = 150 °C

(1) δ = 1; DC (3) δ = 0.2; f = 20 kHz
(2) δ = 0.5; f = 20 kHz (4) δ = 0.1; f = 20 kHz

Fig 9. Average forward current as a function of solder point temperature; typical values

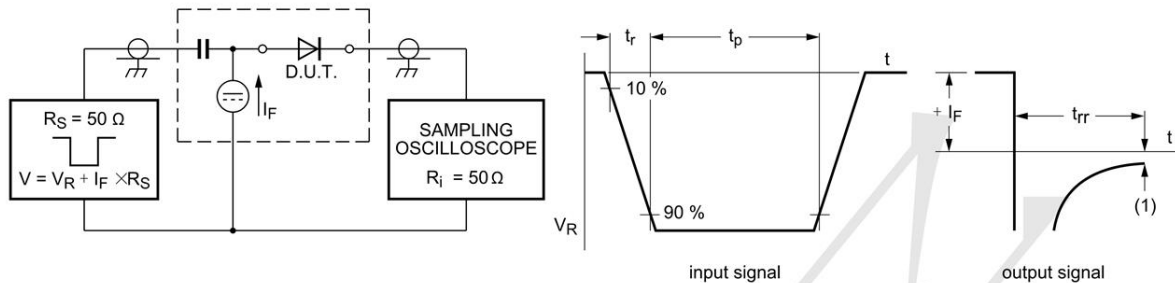

(1) $I_R = 1 \text{ mA}$

Input signal: reverse pulse rise time $t_r = 0.6 \text{ ns}$; reverse voltage pulse duration $t_p = 100 \text{ ns}$; duty cycle $\delta = 0.05$

Oscilloscope: rise time $t_r = 0.35 \text{ ns}$

Fig 10. Reverse recovery time test circuit and waveforms

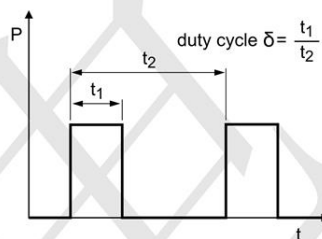
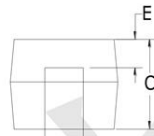
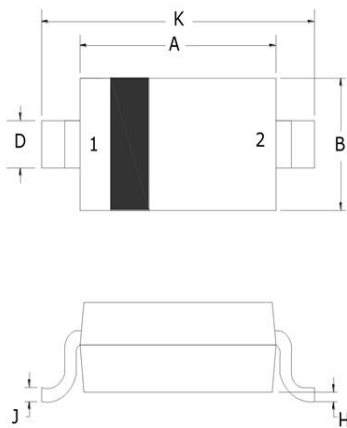

Fig 11. Duty cycle definition

The current ratings for the typical waveforms as shown in Figure 7, 8 and 9 are calculated according to the equations: $I_{FAV} = I_M \times \delta$ with I_M defined as peak current,

$I_{RMS} = I_{F(AV)}$ at DC, and $I_{RMS} = I_M \times \sqrt{\delta}$ with I_{RMS} defined as RMS current.

Outline Drawing - SOD-323



Dim	Millimeters		Inches	
	Min	Max	Min	Max
A	1.60	1.80	0.063	0.071
B	1.2	1.40	0.047	0.055
C	0.80	0.90	0.031	0.035
D	0.25	0.35	0.010	0.014
E	0.15REF		0.006REF	
H	0	0.10	0	0.004
J	0.08	0.15	0.003	0.006
K	2.50	2.70	0.098	0.106

Land Pattern - SOD-323

