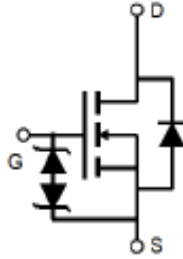
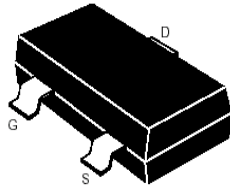

SOT-23

Features

- Low $R_{DS(on)}$ @ $V_{GS}=4.5V$
- 3.3V Logic Level Control
- N Channel SOT23 Package
- HMB ESD Protection 2KV
- Pb-Free, RoHS Compliant

Applications

- DC-to-DC converters
- Power management in battery-driven portables
- Low-side load switch and charging switch for portable devices
- Switching circuits
- High-speed line driver

$V_{(BR)DSS}$	$R_{DS(ON)}$ Typ	I_D Max
20V	16.2m Ω @ 4.5V	6.5A
	17.3m Ω @ 3.3V	

Order Information

Product	Package	Marking	Packing	Min Unit Quantity
BM3416E	SOT23	A6EF3	3000PCS/Reel	3000PCS

Absolute Maximum Ratings

Stresses exceeding Maximum Ratings may damage the device. Maximum Ratings are stress ratings only. Functional operation above the Recommended Operating Conditions is not implied. Extended exposure to stresses above the Recommended Operating Conditions may affect device reliability.

Symbol	Parameter	Rating	Unit
Common Ratings ($T_A=25^\circ\text{C}$ Unless Otherwise Noted)			
V_{GS}	Gate-Source Voltage	± 8	V
$V_{(BR)DSS}$	Drain-Source Breakdown Voltage	20	V
T_J	Maximum Junction Temperature	150	$^\circ\text{C}$
T_{STG}	Storage Temperature Range	-50 to 150	$^\circ\text{C}$
Mounted on Large Heat Sink			
I_{DM}	Pulse Drain Current Tested ^①	$T_A=25^\circ\text{C}$	26 A
I_D	Continuous Drain Current	$T_A=25^\circ\text{C}$	6.5 A
		$T_A=70^\circ\text{C}$	4.8 A
P_D	Maximum Power Dissipation	$T_A=25^\circ\text{C}$	1.56 W
		$T_A=70^\circ\text{C}$	1 W
$R_{\theta JA}$	Thermal Resistance Junction-Ambient	80	$^\circ\text{C/W}$

Symbol	Parameter	Condition	Min	Typ	Max	Unit
Static Electrical Characteristics @ T_J = 25°C (unless otherwise stated)						
V _{(BR)DSS}	Drain-Source Breakdown Voltage	V _{GS} =0V I _D =250μA	20	--	--	V
I _{DSS}	Zero Gate Voltage Drain Current(T _A =25°C)	V _{DS} =20V, V _{GS} =0V	--	--	1	μA
	Zero Gate Voltage Drain Current(T _A =125°C)	V _{DS} =16V, V _{GS} =0V	--	--	100	uA
I _{GSS}	Gate-Body Leakage Current	V _{GS} =±8V, V _{DS} =0V	--	--	±10	uA
V _{GS(TH)}	Gate Threshold Voltage	V _{DS} =V _{GS} , I _D =250μA	0.4	0.7	1.0	V
R _{DS(ON)}	Drain-Source On-State Resistance②	V _{GS} =4.5V, I _D =5A	--	16.2	20	mΩ
R _{DS(ON)}	Drain-Source On-State Resistance②	V _{GS} =3.3V, I _D =3A	--	17.3	22	mΩ
R _{DS(ON)}	Drain-Source On-State Resistance②	V _{GS} =2.5V, I _D =2A	--	20	25	mΩ
Dynamic Electrical Characteristics @ T_J = 25°C (unless otherwise stated)						
C _{iss}	Input Capacitance	V _{DS} =10V, V _{GS} =0V, f=1MHz	--	450	--	pF
C _{oss}	Output Capacitance		--	108	--	pF
C _{rss}	Reverse Transfer Capacitance		--	80	--	pF
Q _g	Total Gate Charge	V _{DS} =10V I _D =5A, V _{GS} =4.5V	--	8.3	--	nC
Q _{gs}	Gate Source Charge		--	1.4	--	nC
Q _{gd}	Gate Drain Charge		--	4.7	--	nC
Switching Characteristics @ T_J = 25°C (unless otherwise stated)						
t _{d(on)}	Turn on Delay Time	V _{DD} =10V, I _D =1A, R _G =3.3Ω, V _{GS} =4.5V	--	285	--	ns
t _r	Turn on Rise Time		--	345	--	ns
t _{d(off)}	Turn Off Delay Time		-	5.8	--	ns
t _f	Turn Off Fall Time		--	4.2	--	ns
Source Drain Diode Characteristics @ T_J = 25°C (unless otherwise stated)						
I _{SD}	Source drain current(Body Diode)	T _A =25°C	--	--	2	A
V _{SD}	Forward on voltage②	T _J =25°C, I _{SD} =5A, V _{GS} =0V	--	0.78	1.2	V

Notes:

① Pulse width limited by maximum allowable junction temperature

②Pulse test ; Pulse width≤300μs, duty cycle≤2%.



Typical Characteristics

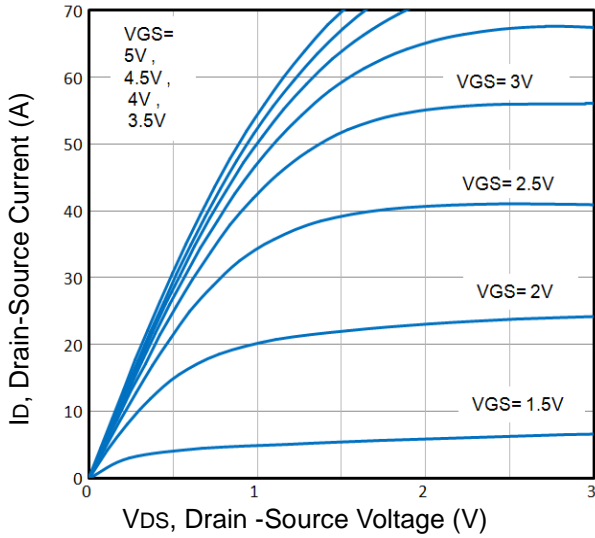

Fig1. Typical Output Characteristics

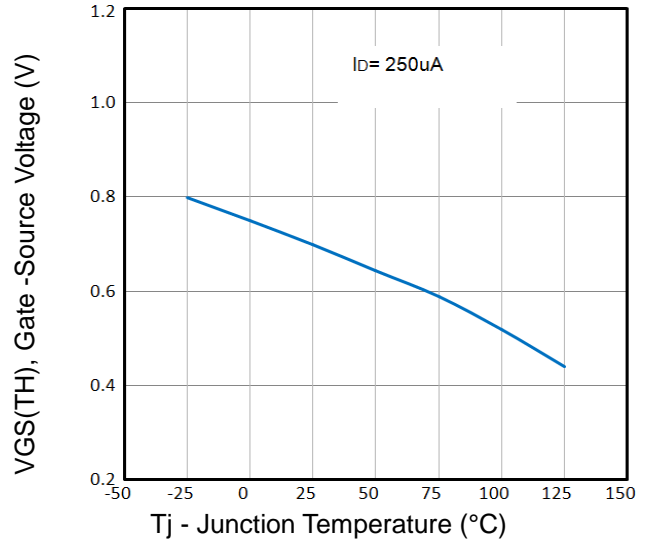

Fig2. VGS(TH) Voltage Vs. Temperature

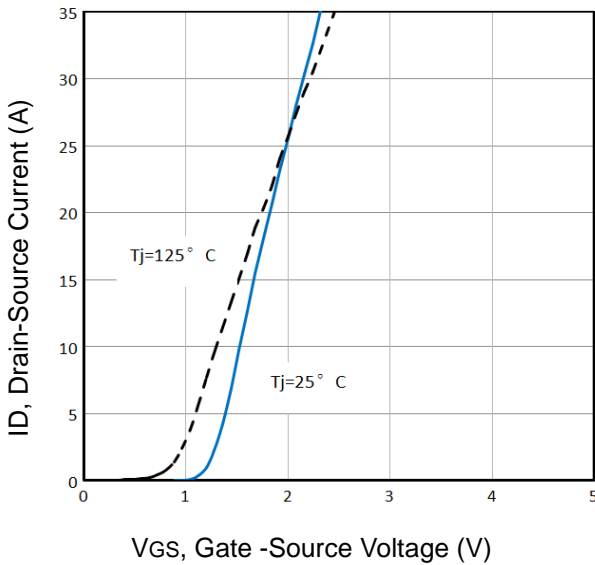

Fig3. Typical Transfer Characteristics

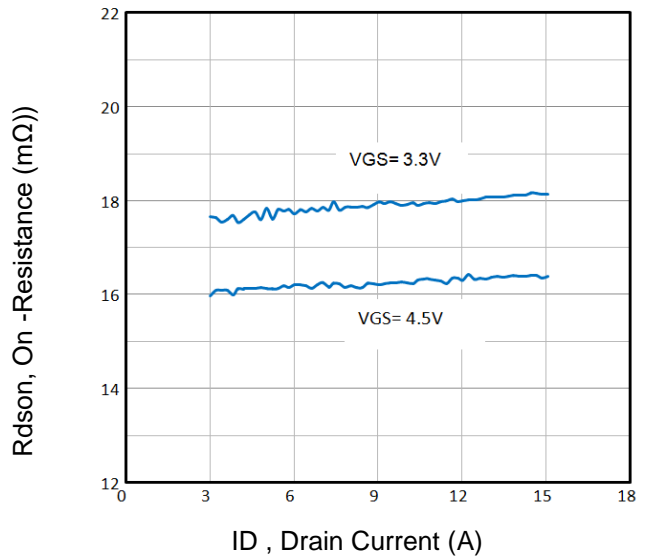

Fig4. On-Resistance vs. Drain Current and Gate

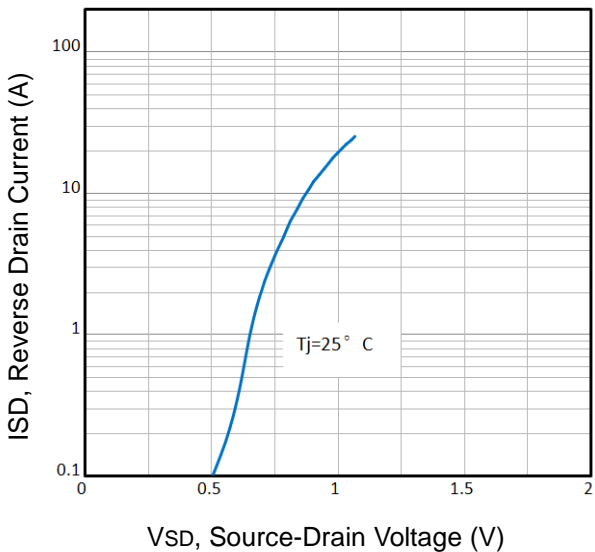

Fig5. Typical Source-Drain Diode Forward Voltage

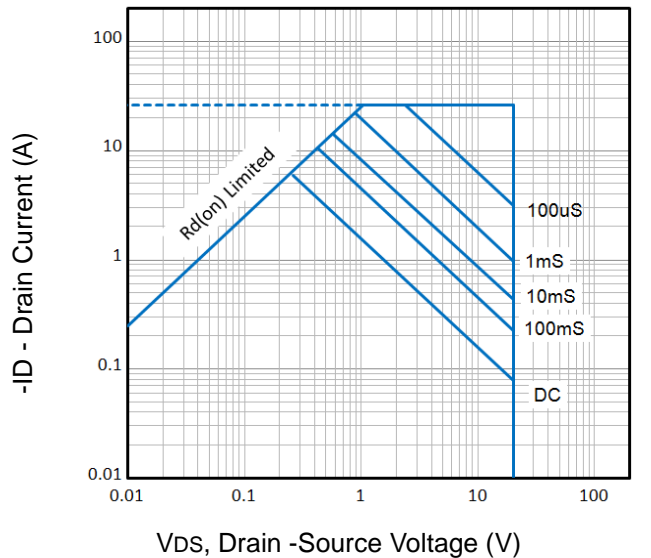

Fig6. Maximum Safe Operating Area

Typical Characteristics

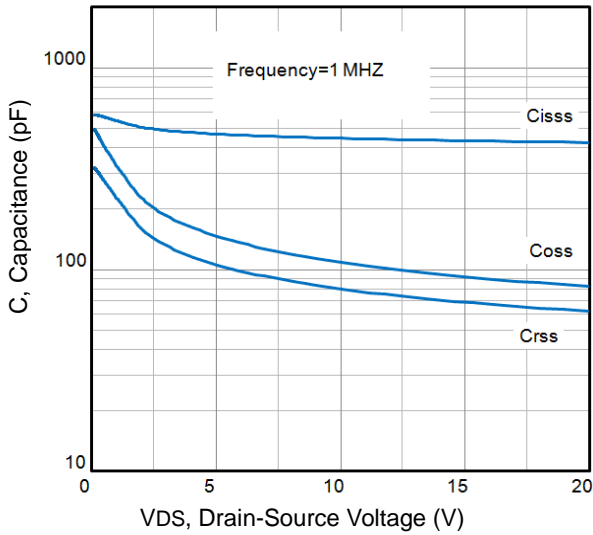

Fig7. Typical Capacitance Vs. Drain-Source Voltage

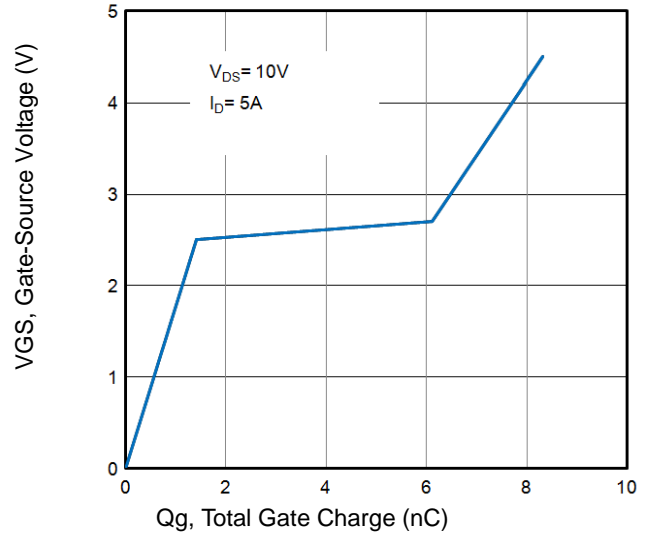

Fig8. Typical Gate Charge Vs. Gate-Source Voltage

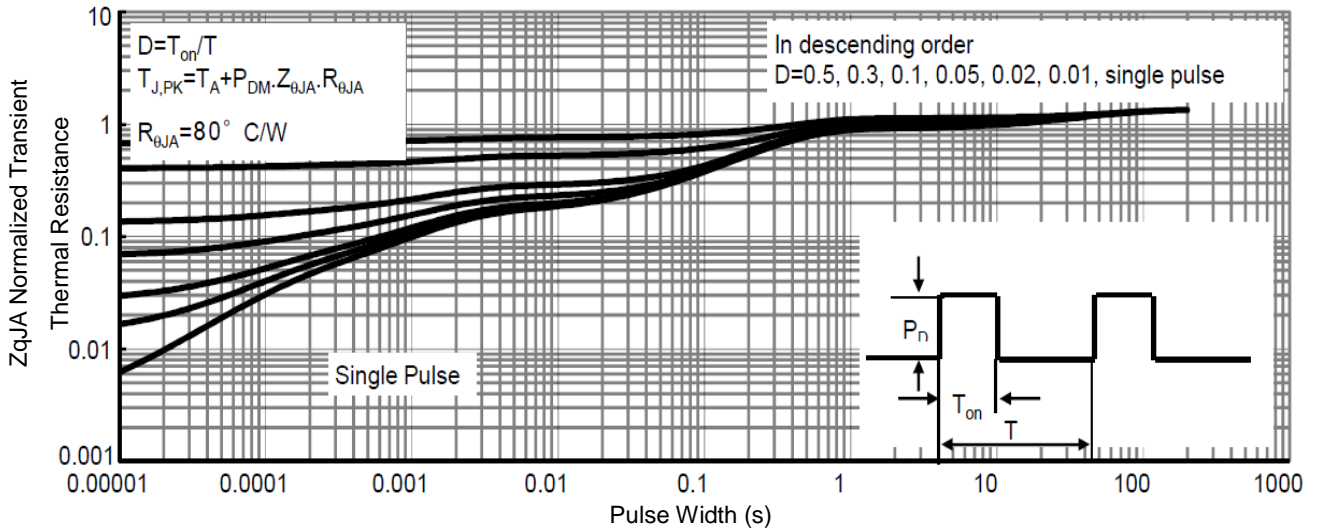
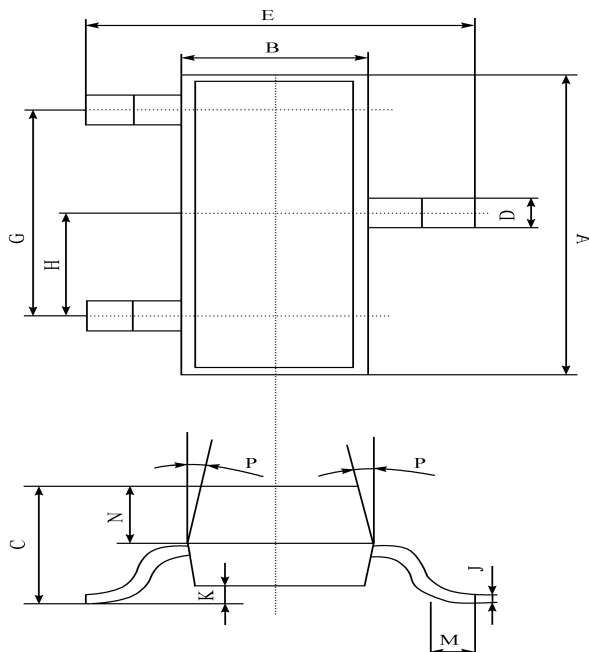

Fig9. Normalized Maximum Transient Thermal Impedance

SOT-23 PACKAGE OUTLINE Plastic surface mounted package



SOT-23	
A	2.90 ± 0.10
B	1.30 ± 0.10
C	1.00 ± 0.10
D	0.40 ± 0.10
E	2.40 ± 0.20
G	1.90 ± 0.10
H	0.95 ± 0.05
J	0.13 ± 0.05
K	0.00-0.10
M	≥ 0.2
N	0.60 ± 0.10
P	7 ± 2°

(UNIT): mm