

单路 2 输入异或门

1 特性

- 符合汽车应用 要求
- 具有符合 AEC-Q100 标准的下列特性：
 - ±4000 V 人体放电模型 (HBM) ESD 分类等级 3A
 - ±1000 V 带电器件模型 (CDM) ESD 分类等级 C5
- 2V 至 5.5V 的工作电压范围
- 电压为 5V 时， t_{pd} 最大值为 10ns
- 低功耗，最大 I_{CC} 为 10 μ A
- 电压为 5V 时，输出驱动为 ±8mA
- 所有输入支持施密特触发操作，使得电路允许输入缓慢上升和下降

2 应用

- 无线耳机
- 电机驱动与控制
- 电视
- 机顶盒
- 音频

4 功能方框图

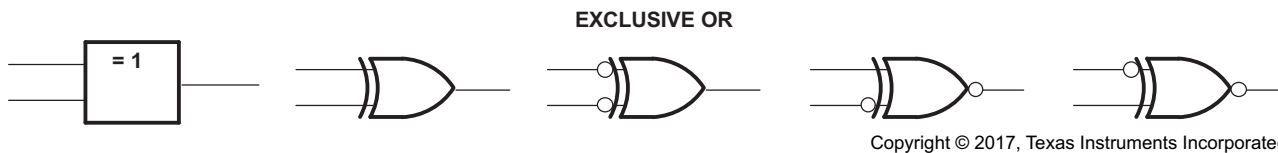

3 说明

SN74AHC1G86-Q1 是一款单通道双输入异或门。该器件采用正逻辑执行布尔函数 $Y = A \oplus B$ 或 $Y = \overline{A}B + A\overline{B}$ 。

常用作真/补元件。如果一个输入为低电平，则可在输出时重新生成真实形态的其它输入。如果一个输入为高电平，另一个输入的信号则可在输出时重新生成反向信号。

器件信息⁽¹⁾

器件型号	封装	封装尺寸 (标称值)
SN74AHC1G86QDBVQ1	SOT-23 (5)	2.90mm x 1.60mm

(1) 如需了解所有可用封装，请参阅产品说明书末尾的可订购产品附录。

目录

1	特性	1	9.1	Overview	8
2	应用	1	9.2	Functional Block Diagram	8
3	说明	1	9.3	Feature Description	8
4	功能方框图	1	9.4	Function Table	9
5	修订历史记录	2	10	Application and Implementation	10
6	Pin Configuration and Functions	3	10.1	Application Information	10
7	Specifications	3	10.2	Typical Application	10
7.1	Absolute Maximum Ratings	3	11	Power Supply Recommendations	11
7.2	ESD Ratings	3	12	Layout	12
7.3	Recommended Operating Conditions	4	12.1	Layout Guidelines	12
7.4	Thermal Information	4	12.2	Layout Example	12
7.5	Electrical Characteristics	5	13	器件和文档支持	13
7.6	Switching Characteristics	6	13.1	接收文档更新通知	13
7.7	Switching Characteristics	6	13.2	社区资源	13
7.8	Operating Characteristics	6	13.3	商标	13
7.9	Typical Characteristics	6	13.4	静电放电警告	13
8	Parameter Measurement Information	7	13.5	Glossary	13
9	Detailed Description	8	14	机械、封装和可订购信息	13

5 修订历史记录

注：之前版本的页码可能与当前版本有所不同。

Changes from Original (April 2011) to Revision A	Page
• 已更改 特性 部分	1
• 已添加 应用 部分	1
• 已更改 说明 部分	1
• Changed Pin Configuration and Functions section	3
• Added T_J spec to Absolute Maximum Ratings table	3
• Changed T_{stg} to -65° (min) and 150°C (max) from -40°C (min) and 125°C (max)	3
• Added ESD Ratings table	3
• Added Thermal Information table	4
• Added Typical Characteristics section	6
• Added Detailed Description section	8
• Added Application and Implementation section	10
• Added Power Supply Recommendations section	11
• Added Layout section	12

6 Pin Configuration and Functions

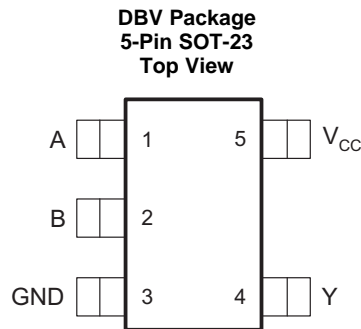

Pin Functions⁽¹⁾

PIN		I/O	DESCRIPTION
NO.	NAME		
1	A	I	Input A
2	B	I	Input B
3	GND	—	Ground
4	Y	O	Output Y
5	V _{CC}	—	Positive Supply

(1) See mechanical drawings for dimensions.

7 Specifications

7.1 Absolute Maximum Ratings

over operating free-air temperature range (unless otherwise noted)

		MIN	MAX	UNIT	
V _{CC}	Supply voltage range	–0.5	7	V	
V _I	Input voltage range ⁽¹⁾	–0.5	7	V	
V _O	Output voltage range applied in the high- or low-state ⁽¹⁾	–0.5	V _{CC} + 0.5	V	
I _{IK}	Input clamp current	V _I < 0 V		–20	V
I _{OK}	Output clamp current	V _O < 0 V or V _O > V _{CC}		±20	mA
I _O	Continuous output current	V _O = 0 V to V _{CC}		±25	mA
	Continuous current through V _{CC} or GND			±50	mA
T _J	Junction temperature			150	°C
T _{stg}	Storage temperature range	–65	150	°C	

(1) The input and output voltage ratings may be exceeded if the input and output current ratings are observed.

7.2 ESD Ratings

		VALUE	UNIT
V _(ESD)	Electrostatic discharge	Human-body model (HBM), per AEC Q100-002 ⁽¹⁾	±4000
		Charged-device model (CDM), per AEC Q100-011	±1000

(1) AEC Q100-002 indicates that HBM stressing shall be in accordance with the ANSI/ESDA/JEDEC JS-001 specification.

7.3 Recommended Operating Conditions

over operating free-air temperature range (unless otherwise noted)

		MIN	MAX	UNIT
V _{CC}	Supply voltage	2	5.5	V
V _{IH}	High-level input voltage	V _{CC} = 2 V	1.5	V
		V _{CC} = 3 V	2.1	
		V _{CC} = 5.5 V	3.85	
V _{IL}	Low-level input voltage	V _{CC} = 2 V	0.5	V
		V _{CC} = 3 V	0.9	
		V _{CC} = 5.5 V	1.65	
V _I	Input voltage	0	5.5	V
V _O	Output voltage	0	V _{CC}	V
I _{OH}	High-level output current	V _{CC} = 2 V	-50	μA
		V _{CC} = 3.3 V ±0.3 V	-4	mA
		V _{CC} = 5 V ±0.5 V	-8	
I _{OL}	Low-level output current	V _{CC} = 2 V	50	μA
		V _{CC} = 3.3 V ±0.3 V	4	mA
		V _{CC} = 5 V ±0.5 V	8	
Δt/ΔV	Input transition rise or fall rate	V _{CC} = 3.3 V ±0.3 V	100	ns/V
		V _{CC} = 5 V ±0.5 V	20	
T _A	Operating free-air temperature	-40	125	°C

7.4 Thermal Information

THERMAL METRIC ⁽¹⁾		SN74AHC1G86-Q1	
		DBV (SOT-23)	
		5 PINS	
			UNIT
R _{θJA}	Junction-to-ambient thermal resistance	224.1	°C/W
R _{θJC(top)}	Junction-to-case (top) thermal resistance	152.8	°C/W
R _{θJB}	Junction-to-board thermal resistance	131.8	°C/W
ψ _{JT}	Junction-to-top characterization parameter	65.7	°C/W
ψ _{JB}	Junction-to-board characterization parameter	131.0	°C/W
R _{θJC(bot)}	Junction-to-case (bottom) thermal resistance	N/A	°C/W

(1) For more information about traditional and new thermal metrics, see the [Semiconductor and IC Package Thermal Metrics](#) application report.

7.5 Electrical Characteristics

over operating free-air temperature range (unless otherwise noted)

PARAMETER	TEST CONDITIONS	V _{CC}	T _A = 25°C			MIN	MAX	UNIT
			MIN	TYP	MAX			
V _{OH}	I _{OH} = -50 μA	2 V	1.9	2		1.9	V	
		3 V	2.9	3		2.9		
		4.5 V	4.4	4.5		4.4		
	I _{OH} = -4 mA	3 V	2.58			2.48		
	I _{OH} = -8 mA	4.5 V	3.94			3.8		
V _{OL}	I _{OL} = 50 μA	2 V			0.1	0.1	V	
		3 V			0.1	0.1		
		4.5 V			0.1	0.1		
	I _{OL} = 4 mA	3 V			0.36	0.44		
	I _{OL} = 8 mA	4.5 V			0.36	0.44		
I _I	V _I = 5.5 V or GND	0 V to 5.5 V			±0.1	±1	μA	
I _{CC}	V _I = V _{CC} or GND, I _O = 0 A	5.5 V			1	10	μA	
C _I	V _I = V _{CC} or GND	5 V		4	10	10	pF	

7.6 Switching Characteristics

over recommended operating free-air temperature range, $V_{CC} = 3.3\text{ V} \pm 0.3\text{ V}$, $T_A = -40^\circ\text{C}$ to 125°C , see

PARAMETER	FROM (INPUT)	TO (OUTPUT)	LOAD CAPACITANCE	$T_A = 25^\circ\text{C}$			MIN	MAX	UNIT
				MIN	TYP	MAX			
t_{PLH}	A or B	Y	$C_L = 50\text{ pF}$	9.5	14.5		1	16.5	ns
t_{PHL}				9.5	14.5		1	16.5	

7.7 Switching Characteristics

over recommended operating free-air temperature range, $V_{CC} = 5\text{ V} \pm 0.5\text{ V}$, $T_A = -40^\circ\text{C}$ to 125°C , see

PARAMETER	FROM (INPUT)	TO (OUTPUT)	LOAD CAPACITANCE	$T_A = 25^\circ\text{C}$			MIN	MAX	UNIT
				MIN	TYP	MAX			
t_{PLH}	A or B	Y	$C_L = 50\text{ pF}$	6.3	8.8		1	10	ns
t_{PHL}				6.3	8.8		1	10	

7.8 Operating Characteristics

$V_{CC} = 5\text{ V}$, $T_A = 25^\circ\text{C}$

PARAMETER	TEST CONDITIONS	TYP	UNIT
C_{pd} Power dissipation capacitance	No load, $f = 1\text{ MHz}$	18	pF

7.9 Typical Characteristics

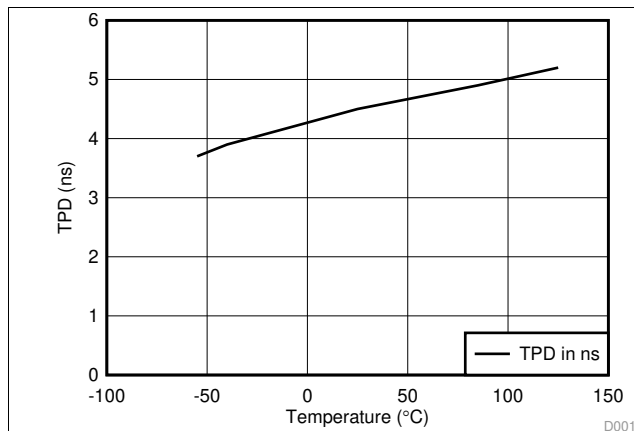

Figure 1. TPD vs Temperature

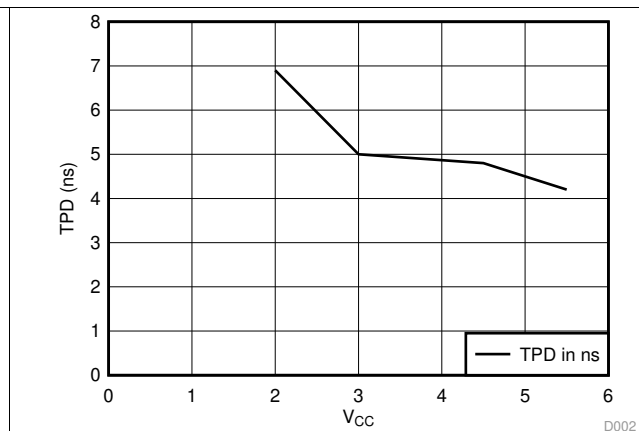
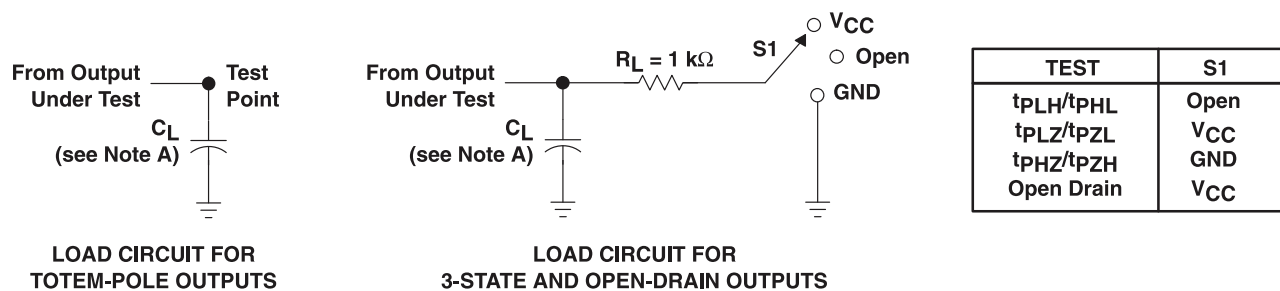

Figure 2. TPD vs V_{CC} at 25°C

8 Parameter Measurement Information



LOAD CIRCUIT FOR TOTEM-POLE OUTPUTS

LOAD CIRCUIT FOR 3-STATE AND OPEN-DRAIN OUTPUTS

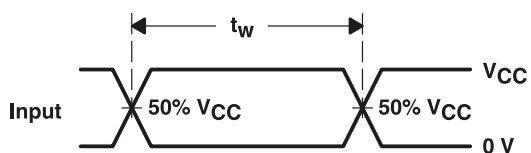

VOLTAGE WAVEFORMS PULSE DURATION

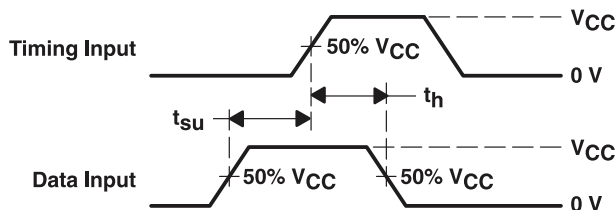

VOLTAGE WAVEFORMS SETUP AND HOLD TIMES

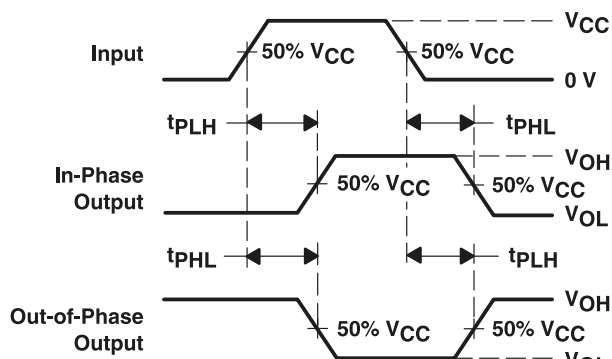

VOLTAGE WAVEFORMS PROPAGATION DELAY TIMES INVERTING AND NONINVERTING OUTPUTS

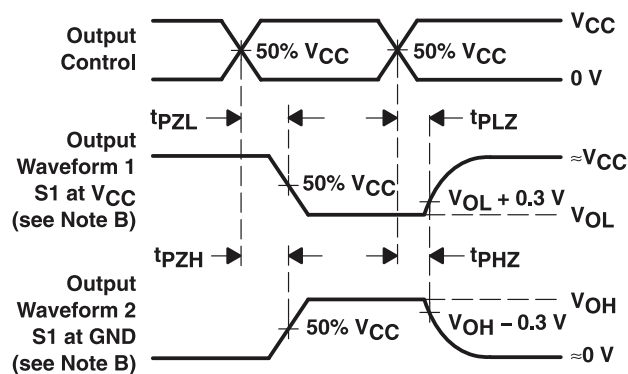

VOLTAGE WAVEFORMS ENABLE AND DISABLE TIMES LOW- AND HIGH-LEVEL ENABLING

- NOTES: A. C_L includes probe and jig capacitance.
 B. Waveform 1 is for an output with internal conditions such that the output is low, except when disabled by the output control. Waveform 2 is for an output with internal conditions such that the output is high, except when disabled by the output control.
 C. All input pulses are supplied by generators having the following characteristics: $PRR \leq 1$ MHz, $Z_O = 50 \Omega$, $t_r \leq 3$ ns, $t_f \leq 3$ ns.
 D. The outputs are measured one at a time, with one input transition per measurement.

Figure 3. Load Circuit and Voltage Waveforms

9 Detailed Description

9.1 Overview

The SN74AHC1G86-Q1 is an automotive qualified device that performs the Boolean function $Y = \bar{A}B + A\bar{B}$ in positive logic. This single 2-input exclusive-OR gate is designed for 2-V to 5.5-V V_{CC} operation.

A common application is as a true or complementary element. If one of the inputs is low, the other input is reproduced in true form at the output. If one of the inputs is high, the signal on the other input is reproduced inverted at the output.

9.2 Functional Block Diagram

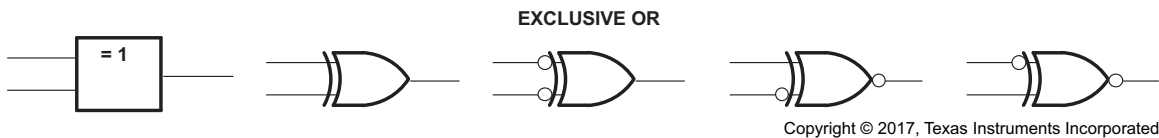

These are five equivalent exclusive-OR symbols valid for an SN74AHC1G86-Q1 gate in positive logic; negation may be shown at any two ports.

9.3 Feature Description

9.3.1 Balanced CMOS Push-Pull Outputs

A balanced output allows the device to sink and source similar currents. The drive capability of this device may create fast edges into light loads so routing and load conditions should be considered to prevent ringing. Additionally, the outputs of this device are capable of driving larger currents than the device can sustain without being damaged. It is important for the output power of the device to be limited to avoid damage due to over-current. The electrical and thermal limits defined in the must be followed at all times.

9.3.2 Standard CMOS Inputs

Standard CMOS inputs are high impedance and are typically modeled as a resistor in parallel with the input capacitance given in the . The worst case resistance is calculated with the maximum input voltage, given in the , and the maximum input leakage current, given in the , using ohm's law ($R = V \div I$).

Signals applied to the inputs need to have fast edge rates, as defined by $\Delta t/\Delta v$ in to avoid excessive current consumption and oscillations. If a slow or noisy input signal is required, a device with a Schmitt-trigger input should be used to condition the input signal prior to the standard CMOS input.

9.3.3 Clamping Diodes

The inputs have negative clamping diodes, and the outputs have positive and negative clamping diodes as depicted in Figure 4.

CAUTION

Voltages beyond the values specified in the table can cause damage to the device. The input negative-voltage and output voltage ratings may be exceeded if the input and output clamp-current ratings are observed.

Feature Description (continued)

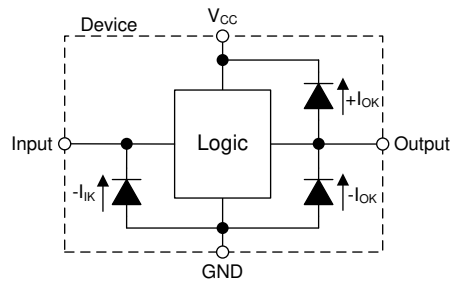

Figure 4. Electrical Placement of Clamping Diodes for Each Input and Output

9.3.4 Over-voltage Tolerant Inputs

Input signals to this device can be driven above the supply voltage so long as they remain below the maximum input voltage value specified in the .

9.4 Function Table

Table 1 lists the functional modes of the SN74AHC1G86-Q1 device.

Table 1. Function Table

INPUTS		OUTPUT Y
A	B	
L	L	L
L	H	H
H	L	H
H	H	L

10 Application and Implementation

NOTE

Information in the following applications sections is not part of the TI component specification, and TI does not warrant its accuracy or completeness. TI's customers are responsible for determining suitability of components for their purposes. Customers should validate and test their design implementation to confirm system functionality.

10.1 Application Information

The SN74AHC1G86-Q1 is a low-drive CMOS device that can be used for a multitude of bus interface type applications where output ringing is a concern. The low drive and slow edge rates will minimize overshoot and undershoot on the outputs. The inputs can accept voltages to 5.5 V at any valid V_{CC} making it ideal for down translation.

10.2 Typical Application

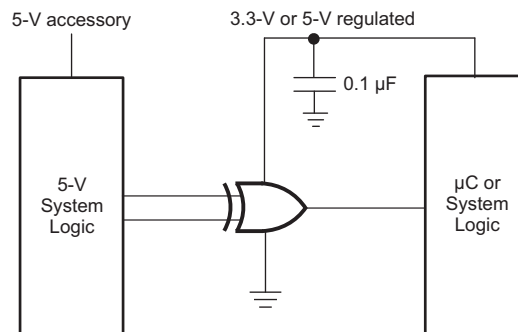

Figure 5. Typical Application Schematic

10.2.1 Design Requirements

This device uses CMOS technology and has balanced output drive. Take care to avoid bus contention because it can drive currents that would exceed maximum limits.

10.2.2 Detailed Design Procedure

1. Recommended Input Conditions
 - For rise time and fall time specifications, see $\Delta t/\Delta V$ in the table.
 - For specified High and low levels, see V_{IH} and V_{IL} in the table.
 - Inputs are overvoltage tolerant allowing them to go as high as 5.5 V at any valid V_{CC} .
2. Recommended Output Conditions
 - Load currents should not exceed 8 mA per output.
 - Outputs should not be pulled above V_{CC} .

Typical Application (continued)

10.2.3 Application Curve

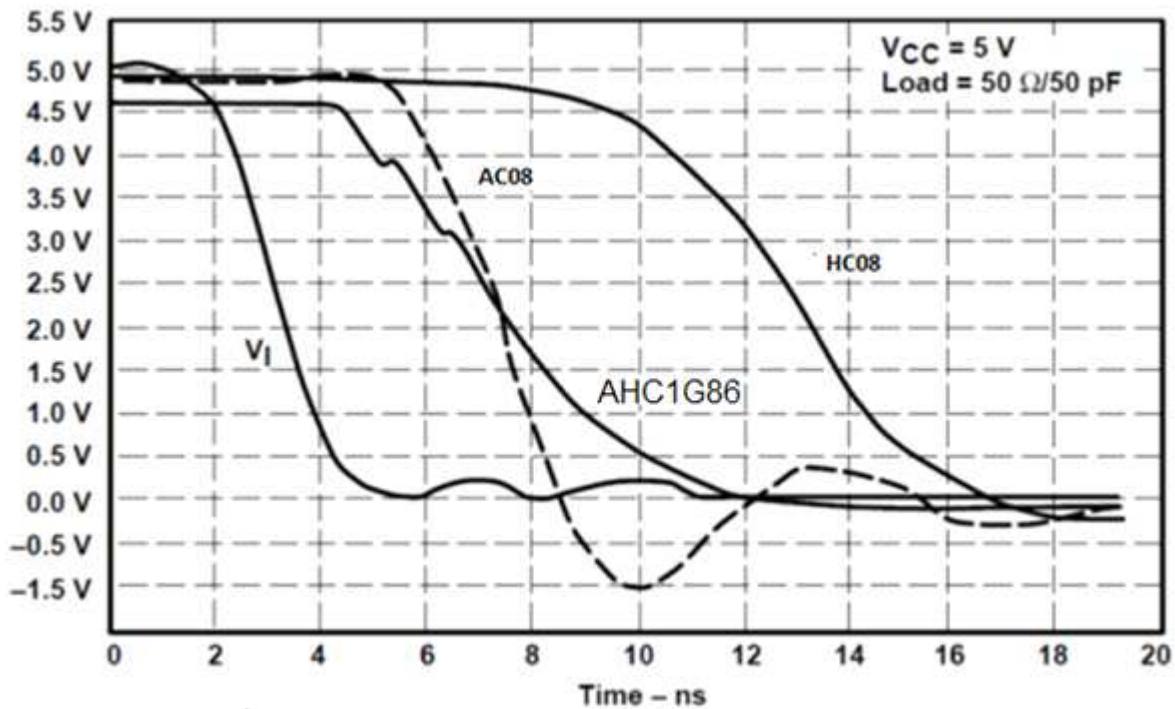

Figure 6. Switching Characteristics Comparison

11 Power Supply Recommendations

The power supply can be any voltage between the minimum and maximum supply voltage rating located in the table.

Each V_{CC} pin must have a good bypass capacitor to prevent power disturbance. For devices with a single supply, 0.1 μF is recommended. If there are multiple V_{CC} pins, 0.01 μF or 0.022 μF is recommended for each power pin. It is acceptable to parallel multiple bypass caps to reject different frequencies of noise. A 0.1- μF and 1- μF are commonly used in parallel. The bypass capacitor must be installed as close to the power pin as possible for best results.

12 Layout

12.1 Layout Guidelines

Even low data rate digital signals can have high frequency signal components due to fast edge rates. When a PCB trace turns a corner at a 90° angle, a reflection can occur. A reflection occurs primarily because of the change of width of the trace. At the apex of the turn, the trace width increases to 1.414 times the width. This increase upsets the transmission-line characteristics, especially the distributed capacitance and self-inductance of the trace which results in the reflection. Not all PCB traces can be straight and therefore some traces must turn corners. shows progressively better techniques of rounding corners. Only the last example (BEST) maintains constant trace width and minimizes reflections.

12.2 Layout Example

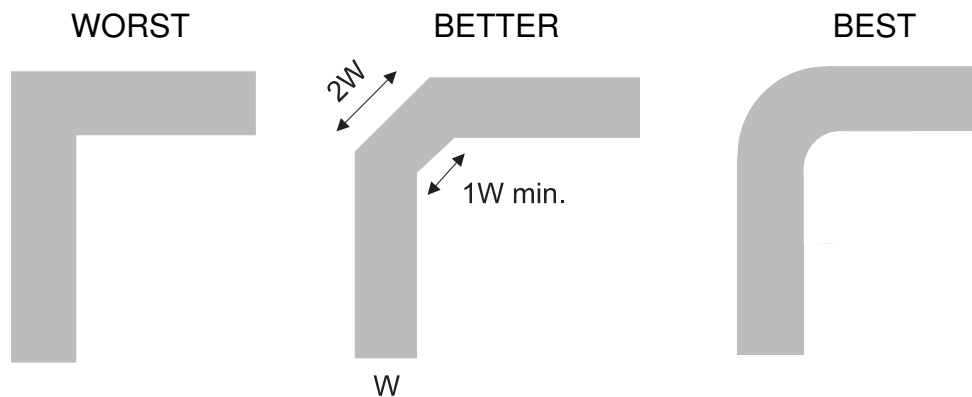

Figure 7. Trace Example

13 器件和文档支持

13.1 接收文档更新通知

要接收文档更新通知，请导航至 ti.com 上的器件产品文件夹。单击右上角的通知我进行注册，即可每周接收产品信息更改摘要。有关更改的详细信息，请查看任何已修订文档中包含的修订历史记录。

13.2 社区资源

The following links connect to TI community resources. Linked contents are provided "AS IS" by the respective contributors. They do not constitute TI specifications and do not necessarily reflect TI's views; see TI's [Terms of Use](#).

TI E2E™ Online Community *TI's Engineer-to-Engineer (E2E) Community*. Created to foster collaboration among engineers. At e2e.ti.com, you can ask questions, share knowledge, explore ideas and help solve problems with fellow engineers.

Design Support *TI's Design Support* Quickly find helpful E2E forums along with design support tools and contact information for technical support.

13.3 商标

E2E is a trademark of Texas Instruments.
All other trademarks are the property of their respective owners.

13.4 静电放电警告



ESD 可能会损坏该集成电路。德州仪器 (TI) 建议通过适当的预防措施处理所有集成电路。如果不遵守正确的处理措施和安装程序，可能会损坏集成电路。

ESD 的损坏小至导致微小的性能降级，大至整个器件故障。精密的集成电路可能更容易受到损坏，这是因为非常细微的参数更改都可能会导致器件与其发布的规格不相符。

13.5 Glossary

SLYZ022 — *TI Glossary*.

This glossary lists and explains terms, acronyms, and definitions.

14 机械、封装和可订购信息

以下页面包含机械、封装和可订购信息。这些信息是指定器件的最新可用数据。数据如有变更，恕不另行通知，且不会对此文档进行修订。如需获取此数据表的浏览器版本，请查阅左侧的导航栏。

重要声明和免责声明

TI 均以“原样”提供技术性 & 可靠性数据（包括数据表）、设计资源（包括参考设计）、应用或其他设计建议、网络工具、安全信息和其他资源，不保证其中不含任何瑕疵，且不做任何明示或暗示的担保，包括但不限于对适销性、适合某特定用途或不侵犯任何第三方知识产权的暗示担保。

所述资源可供专业开发人员应用 TI 产品进行设计使用。您将对以下行为独自承担全部责任：(1) 针对您的应用选择合适的 TI 产品；(2) 设计、验证并测试您的应用；(3) 确保您的应用满足相应标准以及任何其他安全、安保或其他要求。所述资源如有变更，恕不另行通知。TI 对您使用所述资源的授权仅限于开发资源所涉及 TI 产品的相关应用。除此之外不得复制或展示所述资源，也不提供其它 TI 或任何第三方的知识产权授权许可。如因使用所述资源而产生任何索赔、赔偿、成本、损失及债务等，TI 对此概不负责，并且您须赔偿由此对 TI 及其代表造成的损害。

TI 所提供产品均受 TI 的销售条款 (<http://www.ti.com.cn/zh-cn/legal/termsofsale.html>) 以及 [ti.com.cn](http://www.ti.com.cn) 上或随附 TI 产品提供的其他可适用条款的约束。TI 提供所述资源并不扩展或以其他方式更改 TI 针对 TI 产品所发布的可适用的担保范围或担保免责声明。

邮寄地址：上海市浦东新区世纪大道 1568 号中建大厦 32 楼，邮政编码：200122
Copyright © 2019 德州仪器半导体技术（上海）有限公司

PACKAGING INFORMATION

Orderable Device	Status (1)	Package Type	Package Drawing	Pins	Package Qty	Eco Plan (2)	Lead/Ball Finish (6)	MSL Peak Temp (3)	Op Temp (°C)	Device Marking (4/5)	Samples
SN74AHC1G86QDBVRQ1	ACTIVE	SOT-23	DBV	5	3000	Green (RoHS & no Sb/Br)	NIPDAU	Level-1-260C-UNLIM	-40 to 125	ACYU	Samples

(1) The marketing status values are defined as follows:

ACTIVE: Product device recommended for new designs.

LIFEBUY: TI has announced that the device will be discontinued, and a lifetime-buy period is in effect.

NRND: Not recommended for new designs. Device is in production to support existing customers, but TI does not recommend using this part in a new design.

PREVIEW: Device has been announced but is not in production. Samples may or may not be available.

OBSOLETE: TI has discontinued the production of the device.

(2) **RoHS:** TI defines "RoHS" to mean semiconductor products that are compliant with the current EU RoHS requirements for all 10 RoHS substances, including the requirement that RoHS substance do not exceed 0.1% by weight in homogeneous materials. Where designed to be soldered at high temperatures, "RoHS" products are suitable for use in specified lead-free processes. TI may reference these types of products as "Pb-Free".

RoHS Exempt: TI defines "RoHS Exempt" to mean products that contain lead but are compliant with EU RoHS pursuant to a specific EU RoHS exemption.

Green: TI defines "Green" to mean the content of Chlorine (Cl) and Bromine (Br) based flame retardants meet JS709B low halogen requirements of <=1000ppm threshold. Antimony trioxide based flame retardants must also meet the <=1000ppm threshold requirement.

(3) MSL, Peak Temp. - The Moisture Sensitivity Level rating according to the JEDEC industry standard classifications, and peak solder temperature.

(4) There may be additional marking, which relates to the logo, the lot trace code information, or the environmental category on the device.

(5) Multiple Device Markings will be inside parentheses. Only one Device Marking contained in parentheses and separated by a "~" will appear on a device. If a line is indented then it is a continuation of the previous line and the two combined represent the entire Device Marking for that device.

(6) Lead/Ball Finish - Orderable Devices may have multiple material finish options. Finish options are separated by a vertical ruled line. Lead/Ball Finish values may wrap to two lines if the finish value exceeds the maximum column width.

Important Information and Disclaimer:The information provided on this page represents TI's knowledge and belief as of the date that it is provided. TI bases its knowledge and belief on information provided by third parties, and makes no representation or warranty as to the accuracy of such information. Efforts are underway to better integrate information from third parties. TI has taken and continues to take reasonable steps to provide representative and accurate information but may not have conducted destructive testing or chemical analysis on incoming materials and chemicals. TI and TI suppliers consider certain information to be proprietary, and thus CAS numbers and other limited information may not be available for release.

In no event shall TI's liability arising out of such information exceed the total purchase price of the TI part(s) at issue in this document sold by TI to Customer on an annual basis.

TAPE AND REEL INFORMATION



QUADRANT ASSIGNMENTS FOR PIN 1 ORIENTATION IN TAPE



*All dimensions are nominal

Device	Package Type	Package Drawing	Pins	SPQ	Reel Diameter (mm)	Reel Width W1 (mm)	A0 (mm)	B0 (mm)	K0 (mm)	P1 (mm)	W (mm)	Pin1 Quadrant
SN74AHC1G86QDBVRQ 1	SOT-23	DBV	5	3000	179.0	8.4	3.2	3.2	1.4	4.0	8.0	Q3

TAPE AND REEL BOX DIMENSIONS



*All dimensions are nominal

Device	Package Type	Package Drawing	Pins	SPQ	Length (mm)	Width (mm)	Height (mm)
SN74AHC1G86QDBVRQ1	SOT-23	DBV	5	3000	203.0	203.0	35.0

DBV0005A



PACKAGE OUTLINE

SOT-23 - 1.45 mm max height

SMALL OUTLINE TRANSISTOR

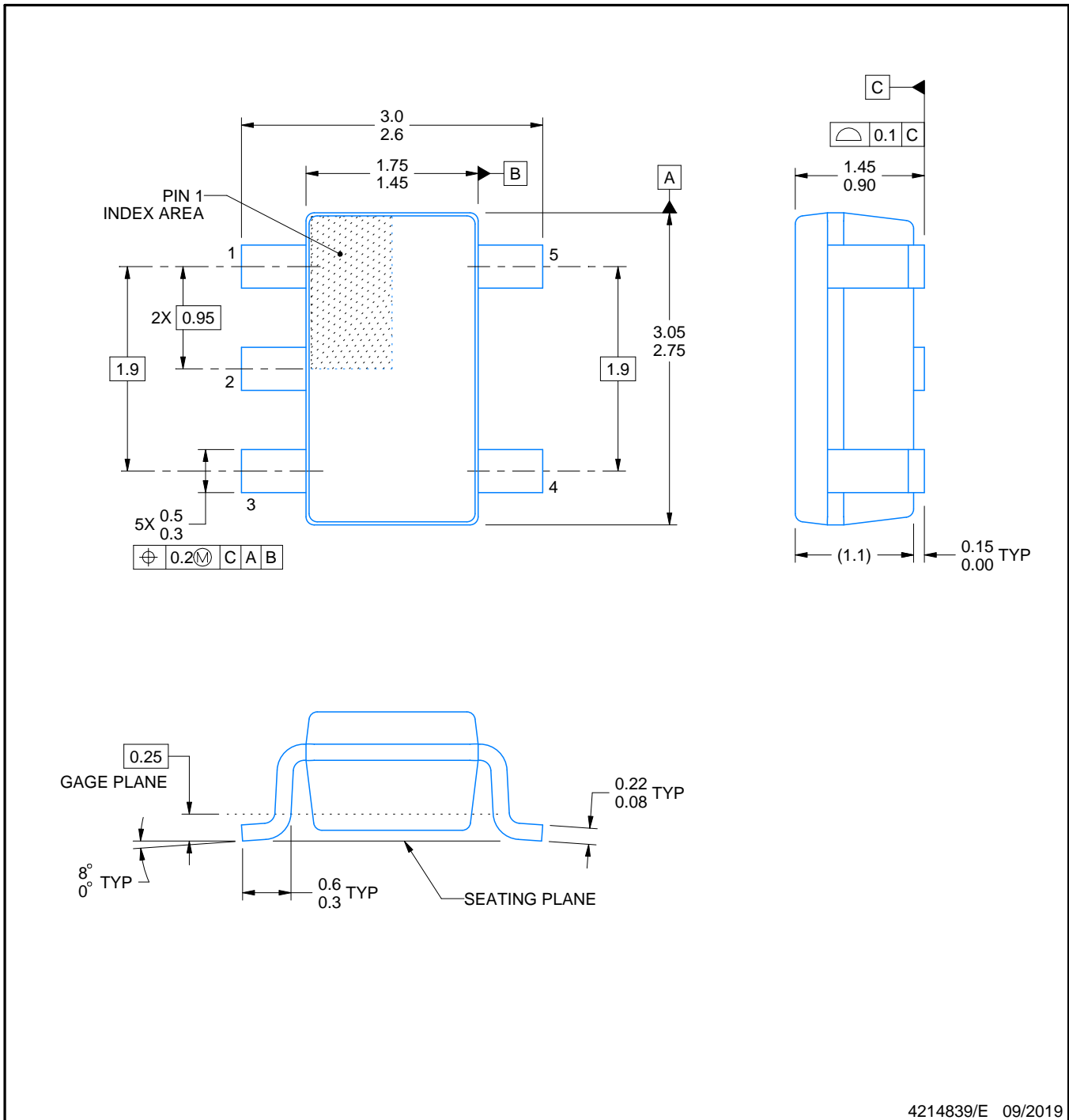

4214839/E 09/2019

NOTES:

1. All linear dimensions are in millimeters. Any dimensions in parenthesis are for reference only. Dimensioning and tolerancing per ASME Y14.5M.
2. This drawing is subject to change without notice.
3. Reference JEDEC MO-178.
4. Body dimensions do not include mold flash, protrusions, or gate burrs. Mold flash, protrusions, or gate burrs shall not exceed 0.15 mm per side.

EXAMPLE BOARD LAYOUT

DBV0005A

SOT-23 - 1.45 mm max height

SMALL OUTLINE TRANSISTOR

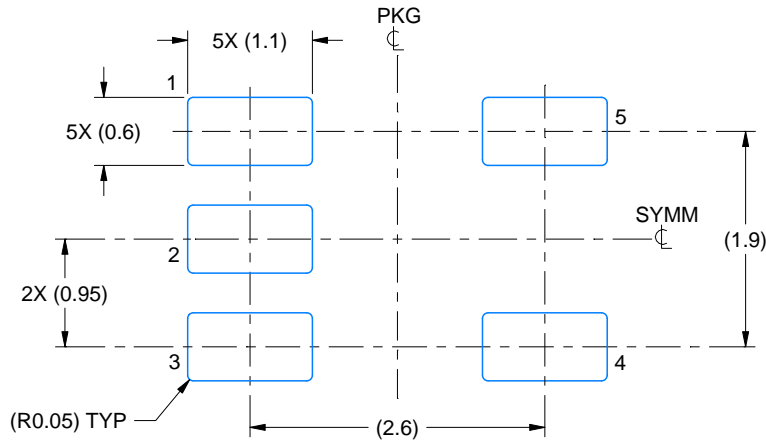

LAND PATTERN EXAMPLE
EXPOSED METAL SHOWN
SCALE:15X



SOLDER MASK DETAILS

4214839/E 09/2019

NOTES: (continued)

- 5. Publication IPC-7351 may have alternate designs.
- 6. Solder mask tolerances between and around signal pads can vary based on board fabrication site.

EXAMPLE STENCIL DESIGN

DBV0005A

SOT-23 - 1.45 mm max height

SMALL OUTLINE TRANSISTOR



SOLDER PASTE EXAMPLE
BASED ON 0.125 mm THICK STENCIL
SCALE:15X

4214839/E 09/2019

NOTES: (continued)

7. Laser cutting apertures with trapezoidal walls and rounded corners may offer better paste release. IPC-7525 may have alternate design recommendations.
8. Board assembly site may have different recommendations for stencil design.

重要声明和免责声明

TI 均以“原样”提供技术性及其可靠性数据（包括数据表）、设计资源（包括参考设计）、应用或其他设计建议、网络工具、安全信息和其他资源，不保证其中不含任何瑕疵，且不做任何明示或暗示的担保，包括但不限于对适销性、适合某特定用途或不侵犯任何第三方知识产权的暗示担保。

所述资源可供专业开发人员应用TI 产品进行设计使用。您将对以下行为独自承担全部责任：(1) 针对您的应用选择合适的TI 产品；(2) 设计、验证并测试您的应用；(3) 确保您的应用满足相应标准以及任何其他安全、安保或其他要求。所述资源如有变更，恕不另行通知。TI 对您使用所述资源的授权仅限于开发资源所涉及TI 产品的相关应用。除此之外不得复制或展示所述资源，也不提供其它TI 或任何第三方的知识产权授权许可。如因使用所述资源而产生任何索赔、赔偿、成本、损失及债务等，TI 对此概不负责，并且您须赔偿由此对TI 及其代表造成的损害。

TI 所提供产品均受TI 的销售条款 (<http://www.ti.com.cn/zh-cn/legal/termsofsale.html>) 以及 [ti.com.cn](http://www.ti.com.cn) 上或随附TI 产品提供的其他可适用条款的约束。TI 提供所述资源并不扩展或以其他方式更改TI 针对TI 产品所发布的可适用的担保范围或担保免责声明。

邮寄地址：上海市浦东新区世纪大道 1568 号中建大厦 32 楼，邮政编码：200122

Copyright © 2020 德州仪器半导体技术（上海）有限公司