

Description

CNR D/V/P/H series metal oxide varistor are nonlinear resistors, consisting main of zinc oxide and several kinds of metal oxide additive.They are bilateral and symmetrical V-I characteristics curve and unparalleled large peak current capability are used for absorption of transient voltage, suppression of pulse noise and circuit voltage stabilization.



Agency Approvals		
Agency	Agency Approval	Certificate No.
	UL 1449 4 th & cUL	VZCA2.E316325 VZCA8.E316325
	IEC 61051-1:2007-04	40008220
	IEC 61051-2:2009-05	
	IEC 61051-2-2:1991-01	
	IEC 60950-1:2013 for 10mm,14mm,18mm and 20mm only	
	CLASS 2221 01	1081695
	GB/T 10193-1997	CQC14001119255
	GB/T 10194-1997	CQC02001002471
	GB 4943.1-2011	CQC08001023767
	GB 8898 -2011	CQC08001023768 CQC08001023769

Features
1. RoHS compliant
2. Halogen-free series are available
3. Body size: $\varnothing 05 \sim \varnothing 20\text{mm}$
4. CNR-10D181K~10D112K ,CNR-14D181K~14D112K, CNR-18D180K~18D112K ,CNR-20D181K~20D112K, meet IEC 60950-1:2013 Annex Q requirement.
Applications
1. Power supply
2. Home appliance
3. Industrial equipment
4. Telecommunication or telephone system
5. Smart meter
6. Lighting products
7. Photovoltaic industry

Max. Rating		
	D-Series	Units
AC Voltage Range (Vac)	11 to 1000	V
DC Voltage Range(Vdc)	14 to 1465	V
Peak Current for 8/20 μ S Current Wave	100 to 6500	A
Energy Range For 10/1000 μ S Current Wave	0.4 to 620	J
Operation Ambient Temperature Range	-40 to +105	$^{\circ}\text{C}$
Storage Temperature Range	-40 to +125	$^{\circ}\text{C}$
Varistor Voltage Range Vn(Vdc)	18 to 1800	V
Insulation Resistance	>1000	M Ω
Typical Response Time	<25	ns







Device Ratings and Characteristics														
Part No.	Device Marking	Maximum Allowable Voltage		Varistor Voltage (@ 1mA)			Clamping Voltage @ Test Current (@8/20µs)		Maximum Energy (@10/1000µs)	Maximum Peak Current (@8/20µs)	Rated Power	Typical Capacitance (@1KHz)	UL 1449 4th ,In @8/20us	Related Standards Symbol
		ACrms(V)	DC(V)	Vn(Vdc)	Min.	Max.	Vc(V)	Ip(A)	(J)	(A)	(W)	(pF)	(KA)	
CNR-05D180K	05D180K	11	14	18	16	20	40	1	0.4	100	0.01	1600	0.1	○
CNR-05D220K	05D220K	14	18	22	20	24	48	1	0.5	100	0.01	1500		○
CNR-05D270K	05D270K	17	22	27	24	30	60	1	0.6	100	0.01	1450		○
CNR-05D330K	05D330K	20	26	33	30	36	73	1	0.8	100	0.01	1400		○
CNR-05D390K	05D390K	25	31	39	35	43	86	1	0.9	100	0.01	700		○
CNR-05D470K	05D470K	30	38	47	42	52	104	1	1.1	100	0.01	650		○
CNR-05D560K	05D560K	35	45	56	50	62	123	1	1.3	100	0.01	600		○
CNR-05D680K	05D680K	40	56	68	61	75	150	1	1.6	100	0.01	580		○
CNR-05D820K	05D820K	50	65	82	74	90	145	5	2.5	400	0.10	310	0.25	□
CNR-05D101K	05D101K	60	85	100	90	110	175	5	3.0	400	0.10	290		□
CNR-05D121K	05D121K	75	100	120	108	132	210	5	4.0	400	0.10	270		□
CNR-05D151K	05D151K	95	125	150	135	165	260	5	4.8	400	0.10	240		□
CNR-05D181K	05D181K	115	150	180	162	198	315	5	5.9	400	0.10	140		□
CNR-05D201K	05D201K	130	170	200	180	220	355	5	6.5	400	0.10	120		◇
CNR-05D221K	05D221K	140	180	220	198	242	380	5	7.0	400	0.10	110		◇
CNR-05D241K	05D241K	150	200	240	216	264	415	5	8.0	400	0.10	110		◇
CNR-05D271K	05D271K	175	225	270	243	297	475	5	8.5	400	0.10	100		◇
CNR-05D301K	05D301K	195	250	300	270	330	505	5	9.0	400	0.10	100		◇
CNR-05D331K	05D331K	215	275	330	297	363	585	5	10.0	400	0.10	90		◇
CNR-05D361K	05D361K	230	300	360	324	396	620	5	10.0	400	0.10	80		◇
CNR-05D391K	05D391K	250	320	390	351	429	675	5	12.0	400	0.10	80		◇
CNR-05D431K	05D431K	275	350	430	387	473	745	5	13.0	400	0.10	70		◇
CNR-05D471K	05D471K	300	385	470	423	517	810	5	15.0	400	0.10	70		◇
CNR-05D511K	05D511K	320	410	510	459	561	878	5	16.0	400	0.10	65		◇
CNR-05D561K	05D561K	350	460	560	504	616	940	5	18.0	400	0.10	65	◇	
CNR-05D621K	05D621K	395	510	620	558	682	1050	5	18.0	400	0.10	65	◇	
CNR-05D681K	05D681K	420	560	680	612	748	1120	5	18.0	400	0.10	60	◇	
CNR-05D751K	05D751K	460	615	750	675	825	1240	5	18.0	400	0.10	60	◇	

Related Standards

Symbols	○	□	◇
Approval		   	   





Device Ratings and Characteristics														
Part No.	Device Marking	Maximum Allowable Voltage		Varistor Voltage (@ 1mA)			Clamping Voltage @ Test Current (@8/20µs)		Maximum Energy (@10/1000µs)	Maximum Peak Current (@8/20µs)	Rated Power	Typical Capacitance (@1KHz)	UL 1449 4th ,In @8/20us	Related Standards Symbol
		ACrms(V)	DC(V)	Vn(Vdc)	Min.	Max.	Vc(V)	Ip(A)	(J)	(A)	(W)	(pF)	(KA)	
CNR-07D180K	07D180K	11	14	18	16	20	36	2.5	0.9	250	0.02	3800	0.15	○
CNR-07D220K	07D220K	14	18	22	20	24	43	2.5	1.1	250	0.02	3600		○
CNR-07D270K	07D270K	17	22	27	24	30	53	2.5	1.4	250	0.02	3400		○
CNR-07D330K	07D330K	20	26	33	30	36	65	2.5	1.7	250	0.02	2900		○
CNR-07D390K	07D390K	25	31	39	35	43	77	2.5	2.1	250	0.02	1600		○
CNR-07D470K	07D470K	30	38	47	42	52	93	2.5	2.5	250	0.02	1550		○
CNR-07D560K	07D560K	35	45	56	50	62	110	2.5	3.1	250	0.02	1500		○
CNR-07D680K	07D680K	40	56	68	61	75	135	2.5	3.6	250	0.02	1200		○
CNR-07D820K	07D820K	50	65	82	74	90	135	10	5.5	1200	0.25	860	0.5	□
CNR-07D101K	07D101K	60	85	100	90	110	165	10	6.5	1200	0.25	750		□
CNR-07D121K	07D121K	75	100	120	108	132	200	10	7.8	1200	0.25	530		□
CNR-07D151K	07D151K	95	125	150	135	165	250	10	9.7	1200	0.25	410		□
CNR-07D181K	07D181K	115	150	180	162	198	300	10	11.7	1200	0.25	300		□
CNR-07D201K	07D201K	130	170	200	180	220	340	10	13	1200	0.25	250		◇
CNR-07D221K	07D221K	140	180	220	198	242	360	10	14	1200	0.25	250		◇
CNR-07D241K	07D241K	150	200	240	216	264	395	10	15	1200	0.25	240		◇
CNR-07D271K	07D271K	175	225	270	243	297	455	10	18	1200	0.25	220		◇
CNR-07D301K	07D301K	195	250	300	270	330	500	10	21	1200	0.25	190		◇
CNR-07D331K	07D331K	215	275	330	297	363	550	10	25	1200	0.25	180		◇
CNR-07D361K	07D361K	230	300	360	324	396	595	10	25	1200	0.25	170		◇
CNR-07D391K	07D391K	250	320	390	351	429	650	10	25	1200	0.25	160		◇
CNR-07D431K	07D431K	275	350	430	387	473	710	10	28	1200	0.25	150		◇
CNR-07D471K	07D471K	300	385	470	423	517	775	10	30	1200	0.25	130		◇
CNR-07D511K	07D511K	320	410	510	459	561	845	10	33	1200	0.25	120		◇
CNR-07D561K	07D561K	350	460	560	504	616	915	10	33	1200	0.25	120		◇
CNR-07D621K	07D621K	395	510	620	558	682	1020	10	35	1200	0.25	120		◇
CNR-07D681K	07D681K	420	560	680	612	748	1120	10	35	1200	0.25	110		◇
CNR-07D751K	07D751K	465	615	750	675	825	1235	10	38	1200	0.25	100		◇
CNR-07D781K	07D781K	485	640	780	702	858	1290	10	40	1200	0.25	90	◇	
CNR-07D821K	07D821K	510	670	820	738	902	1355	10	42	1200	0.25	90	◇	

Related Standards

Symbols	○	□	◇
Approval		  	  



Device Ratings and Characteristics														
Part No.	Device Marking	Maximum Allowable Voltage		Varistor Voltage (@1mA)			Clamping Voltage @ Test Current (@8/20µs)		Maximum Energy (@10/1000µs)	Maximum Peak Current (@8/20µs)	Rated Power	Typical Capacitance (@1KHz)	UL 1449 4th ,In @8/20µs	Related Standards Symbol
		ACrms(V)	DC(V)	Vn(Vdc)	Min.	Max.	Vc(V)	Ip(A)	(J)	(A)	(W)	(pF)	(KA)	
CNR-10D180K	10D180K	11	14	18	16	20	36	5	2.1	500	0.05	16000	0.5	○
CNR-10D220K	10D220K	14	18	22	20	24	43	5	2.5	500	0.05	11000		○
CNR-10D270K	10D270K	17	22	27	24	30	53	5	3.0	500	0.05	8000		○
CNR-10D330K	10D330K	20	26	33	30	36	65	5	4.0	500	0.05	6300		○
CNR-10D390K	10D390K	25	31	39	35	43	77	5	4.6	500	0.05	5200		○
CNR-10D470K	10D470K	30	38	47	42	52	93	5	5.5	500	0.05	4600		○
CNR-10D560K	10D560K	35	45	56	50	62	110	5	7.0	500	0.05	3750		○
CNR-10D680K	10D680K	40	56	68	61	75	135	5	8.2	500	0.05	2800		○
CNR-10D820K	10D820K	50	65	82	74	90	135	25	12	2500	0.4	1920	□	
CNR-10D101K	10D101K	60	85	100	90	110	165	25	15	2500	0.4	1800	□	
CNR-10D121K	10D121K	75	100	120	108	132	200	25	18	2500	0.4	1500	□	
CNR-10D151K	10D151K	95	125	150	135	165	250	25	22	2500	0.4	1200	□	
CNR-10D181K	10D181K	115	150	180	162	198	300	25	27	2500	0.4	620	□	
CNR-10D201K	10D201K	130	170	200	180	220	340	25	30	2500	0.4	570	◇	
CNR-10D221K	10D221K	140	180	220	198	242	360	25	32	2500	0.4	560	◇	
CNR-10D241K	10D241K	150	200	240	216	264	395	25	35	2500	0.4	550	◇	
CNR-10D271K	10D271K	175	225	270	243	297	455	25	40	2500	0.4	530	◇	
CNR-10D301K	10D301K	195	250	300	270	330	500	25	42	2500	0.4	500	◇	
CNR-10D331K	10D331K	215	275	330	297	363	550	25	47	2500	0.4	450	◇	
CNR-10D361K	10D361K	230	300	360	324	396	595	25	47	2500	0.4	450	◇	
CNR-10D391K	10D391K	250	320	390	351	429	650	25	60	2500	0.4	430	◇	
CNR-10D431K	10D431K	275	350	430	387	473	710	25	65	2500	0.4	400	◇	
CNR-10D471K	10D471K	300	385	470	423	517	775	25	70	2500	0.4	300	◇	
CNR-10D511K	10D511K	320	410	510	459	561	845	25	70	2500	0.4	260	◇	
CNR-10D561K	10D561K	350	460	560	504	616	915	25	70	2500	0.4	200	◇	
CNR-10D621K	10D621K	395	510	620	558	682	1020	25	70	2500	0.4	170	◇	
CNR-10D681K	10D681K	420	560	680	612	748	1120	25	70	2500	0.4	160	◇	
CNR-10D751K	10D751K	465	615	750	675	825	1235	25	75	2500	0.4	150	◇	
CNR-10D781K	10D781K	485	640	780	702	858	1290	25	80	2500	0.4	150	◇	
CNR-10D821K	10D821K	510	670	820	738	902	1355	25	85	2500	0.4	150	◇	
CNR-10D911K	10D911K	550	745	910	819	1001	1500	25	93	2500	0.4	140	◇	
CNR-10D102K	10D102K	625	825	1000	900	1100	1650	25	102	2500	0.4	140	◇	
CNR-10D112K	10D112K	680	895	1100	990	1210	1815	25	115	2500	0.4	130	◇	
CNR-10D182K	10D182K	1000	1465	1800	1620	1980	2950	25	185	2500	0.4	75	1	○

Related Standards

Symbols	○	□	◇
Approval		   	   

Device Ratings and Characteristics														
Part No.	Device Marking	Maximum Allowable Voltage		Varistor Voltage (@1mA)			Clamping Voltage @ Test Current (@8/20µs)		Maximum Energy (@10/1000µs)	Maximum Peak Current (@8/20µs)	Rated Power	Typical Capacitance (@1KHz)	UL 1449 4th ,In @8/20us	Related Standards Symbol
		ACrms(V)	DC(V)	Vn(Vdc)	Min.	Max.	Vc(V)	Ip(A)	(J)	(A)	(W)	(pF)	(KA)	
CNR-14D180K	14D180K	11	14	18	16	20	36	10	4	1000	0.1	25000	1	○
CNR-14D220K	14D220K	14	18	22	20	24	43	10	5	1000	0.1	20000		○
CNR-14D270K	14D270K	17	22	27	24	30	53	10	6	1000	0.1	16000		○
CNR-14D330K	14D330K	20	26	33	30	36	65	10	7.5	1000	0.1	12200		○
CNR-14D390K	14D390K	25	31	39	35	43	77	10	8.6	1000	0.1	7000		○
CNR-14D470K	14D470K	30	38	47	42	52	93	10	10	1000	0.1	6750		○
CNR-14D560K	14D560K	35	45	56	50	62	110	10	11	1000	0.1	6500		○
CNR-14D680K	14D680K	40	56	68	61	75	135	10	14	1000	0.1	5500	○	
CNR-14D820K	14D820K	50	65	82	74	90	135	50	22	4500	0.6	4300	□	
CNR-14D101K	14D101K	60	85	100	90	110	165	50	28	4500	0.6	3500	□	
CNR-14D121K	14D121K	75	100	120	108	132	200	50	32	4500	0.6	2500	□	
CNR-14D151K	14D151K	95	125	150	135	165	250	50	40	4500	0.6	2100	□	
CNR-14D181K	14D181K	115	150	180	162	198	300	50	52	4500	0.6	1250	□	
CNR-14D201K	14D201K	130	170	200	180	220	340	50	57	4500	0.6	1150	◇	
CNR-14D221K	14D221K	140	180	220	198	242	360	50	60	4500	0.6	1100	◇	
CNR-14D241K	14D241K	150	200	240	216	264	395	50	63	4500	0.6	1050	◇	
CNR-14D271K	14D271K	175	225	270	243	297	455	50	70	4500	0.6	1000	◇	
CNR-14D301K	14D301K	195	250	300	270	330	500	50	78	4500	0.6	900	◇	
CNR-14D331K	14D331K	215	275	330	297	363	550	50	93	4500	0.6	850	◇	
CNR-14D361K	14D361K	230	300	360	324	396	595	50	93	4500	0.6	800	◇	
CNR-14D391K	14D391K	250	320	390	351	429	650	50	100	4500	0.6	800	◇	
CNR-14D431K	14D431K	275	350	430	387	473	710	50	115	4500	0.6	650	◇	
CNR-14D471K	14D471K	300	385	470	423	517	775	50	125	4500	0.6	550	◇	
CNR-14D511K	14D511K	320	410	510	459	561	845	50	125	4500	0.6	450	◇	
CNR-14D561K	14D561K	350	460	560	504	616	915	50	125	4500	0.6	400	◇	
CNR-14D621K	14D621K	395	510	620	558	682	1020	50	125	4500	0.6	350	◇	
CNR-14D681K	14D681K	420	560	680	612	748	1120	50	130	4500	0.6	350	◇	
CNR-14D751K	14D751K	465	615	750	675	825	1235	50	143	4500	0.6	330	◇	
CNR-14D781K	14D781K	485	640	780	702	858	1290	50	148	4500	0.6	330	◇	
CNR-14D821K	14D821K	510	670	820	738	902	1355	50	157	4500	0.6	330	◇	
CNR-14D911K	14D911K	550	745	910	819	1001	1500	50	175	4500	0.6	300	◇	
CNR-14D102K	14D102K	625	825	1000	900	1100	1650	50	190	4500	0.6	300	◇	
CNR-14D112K	14D112K	680	895	1100	990	1210	1815	50	213	4500	0.6	200	◇	
CNR-14D182K	14D182K	1000	1465	1800	1620	1980	2950	50	354	4500	0.6	150	2	○

Related Standards

Symbols	○	□	◇
Approval			









Device Ratings and Characteristics														
Part No.	Device Marking	Maximum Allowable Voltage		Varistor Voltage (@1mA)			Clamping Voltage @ Test Current (@8/20µs)		Maximum Energy (@10/1000µs)	Maximum Peak Current (@8/20µs)	Rated Power	Typical Capacitance (@1KHz)	UL 1449 4th ,In @8/20µs	Related Standards Symbol
		ACrms(V)	DC(V)	Vn(Vdc)	Min.	Max.	Vc(V)	Ip(A)	(J)	(A)	(W)	(pF)	(KA)	
CNR-18D180K	18D180K	11	14	18	16	20	36	15	8.3	2000	0.15	36400	2	○
CNR-18D220K	18D220K	14	18	22	20	24	43	15	10.4	2000	0.15	27300		○
CNR-18D270K	18D270K	17	22	27	24	30	53	15	12.5	2000	0.15	22290		○
CNR-18D330K	18D330K	20	26	33	30	36	65	15	15.6	2000	0.15	18200		○
CNR-18D390K	18D390K	25	31	39	35	43	77	15	17.9	2000	0.15	12250		○
CNR-18D470K	18D470K	30	38	47	42	52	93	15	20.8	2000	0.15	12280		○
CNR-18D560K	18D560K	35	45	56	50	62	110	15	22.8	2000	0.15	11100		○
CNR-18D680K	18D680K	40	56	68	61	75	135	15	29.1	2000	0.15	10460		○
CNR-18D820K	18D820K	50	65	82	74	90	135	75	30.6	5500	0.80	7460	□	
CNR-18D101K	18D101K	60	85	100	90	110	165	75	38.9	5500	0.80	7280	□	
CNR-18D121K	18D121K	75	100	120	108	132	200	75	44.4	5500	0.80	5000	□	
CNR-18D151K	18D151K	95	125	150	135	165	250	75	55.6	5500	0.80	3820	□	
CNR-18D181K	18D181K	115	150	180	162	198	300	75	69.4	5500	0.80	2270	□	
CNR-18D201K	18D201K	130	170	200	180	220	340	75	79.2	6500	0.80	2100	◇	
CNR-18D221K	18D221K	140	180	220	198	242	360	75	83.3	6500	0.80	2000	◇	
CNR-18D241K	18D241K	150	200	240	216	264	395	75	87.5	6500	0.80	2000	◇	
CNR-18D271K	18D271K	175	225	270	243	297	455	75	97.2	6500	0.80	1910	◇	
CNR-18D301K	18D301K	195	250	300	270	330	500	75	101	6500	0.80	1630	◇	
CNR-18D331K	18D331K	215	275	330	297	363	550	75	129	6500	0.80	1590	◇	
CNR-18D361K	18D361K	230	300	360	324	396	595	75	129	6500	0.80	1540	◇	
CNR-18D391K	18D391K	250	320	390	351	429	650	75	139	6500	0.80	1270	◇	
CNR-18D431K	18D431K	275	350	430	387	473	710	75	160	6500	0.80	1220	◇	
CNR-18D471K	18D471K	300	385	470	423	517	775	75	174	6500	0.80	1090	◇	
CNR-18D511K	18D511K	320	410	510	459	561	845	75	175	6500	0.80	950	◇	
CNR-18D561K	18D561K	350	460	560	504	616	915	75	178	6500	0.80	770	◇	
CNR-18D621K	18D621K	395	510	620	558	682	1020	75	181	6500	0.80	510	◇	
CNR-18D681K	18D681K	420	560	680	612	748	1120	75	182	6500	0.80	500	◇	
CNR-18D751K	18D751K	465	615	750	675	825	1235	75	200	6500	0.80	480	◇	
CNR-18D781K	18D781K	485	640	780	702	858	1290	75	207	6500	0.80	450	◇	
CNR-18D821K	18D821K	510	670	820	738	902	1355	75	220	6500	0.80	450	◇	
CNR-18D911K	18D911K	550	745	910	819	1001	1500	75	245	6500	0.80	430	◇	
CNR-18D102K	18D102K	625	825	1000	900	1100	1650	75	266	6500	0.80	410	◇	
CNR-18D112K	18D112K	680	895	1100	990	1210	1815	75	298	6500	0.80	360	◇	

Related Standards

Symbols	○	□	◇					
Approval								

Device Ratings and Characteristics														
Part No.	Device Marking	Maximum Allowable Voltage		Varistor Voltage (@1mA)			Clamping Voltage @ Test Current (@8/20µs)		Maximum Energy (@10/1000µs)	Maximum Peak Current (@8/20µs)	Rated Power	Typical Capacitance (@1KHz)	UL 1449 4th ,In @8/20µs	Related Standards Symbol
		ACrms(V)	DC(V)	Vn(Vdc)	Min.	Max.	Vc(V)	Ip(A)	(J)	(A)	(W)	(pF)	(KA)	
CNR-20D180K	20D180K	11	14	18	16	20	36	20	11	2000	0.2	40000	2	○
CNR-20D220K	20D220K	14	18	22	20	24	43	20	14	2000	0.2	30000		○
CNR-20D270K	20D270K	17	22	27	24	30	53	20	18	2000	0.2	24500		○
CNR-20D330K	20D330K	20	26	33	30	36	65	20	23	2000	0.2	20000		○
CNR-20D390K	20D390K	25	31	39	35	43	77	20	26	2000	0.2	13800		○
CNR-20D470K	20D470K	30	38	47	42	52	93	20	33	2000	0.2	13500		○
CNR-20D560K	20D560K	35	45	56	50	62	110	20	41	2000	0.2	12200		○
CNR-20D680K	20D680K	40	56	68	61	75	135	20	46	2000	0.2	11500		○
CNR-20D820K	20D820K	50	65	82	74	90	135	100	48	6500	1	8200	□	
CNR-20D101K	20D101K	60	85	100	90	110	165	100	51	6500	1	8000	□	
CNR-20D121K	20D121K	75	100	120	108	132	200	100	55	6500	1	5500	□	
CNR-20D151K	20D151K	95	125	150	135	165	250	100	70	6500	1	4200	□	
CNR-20D181K	20D181K	115	150	180	162	198	300	100	85	6500	1	2500	□	
CNR-20D201K	20D201K	130	170	200	180	220	340	100	95	6500	1	2300	◇	
CNR-20D221K	20D221K	140	180	220	198	242	360	100	100	6500	1	2200	◇	
CNR-20D241K	20D241K	150	200	240	216	264	395	100	108	6500	1	2200	◇	
CNR-20D271K	20D271K	175	225	270	243	297	455	100	127	6500	1	2100	◇	
CNR-20D301K	20D301K	195	250	300	270	330	500	100	150	6500	1	1800	◇	
CNR-20D331K	20D331K	215	275	330	297	363	550	100	163	6500	1	1750	◇	
CNR-20D361K	20D361K	230	300	360	324	396	595	100	163	6500	1	1700	◇	
CNR-20D391K	20D391K	250	320	390	351	429	650	100	180	6500	1	1400	◇	
CNR-20D431K	20D431K	275	350	430	387	473	710	100	190	6500	1	1350	◇	
CNR-20D471K	20D471K	300	385	470	423	517	775	100	220	6500	1	1200	◇	
CNR-20D511K	20D511K	320	410	510	459	561	845	100	220	6500	1	1050	◇	
CNR-20D561K	20D561K	350	460	560	504	616	915	100	220	6500	1	850	◇	
CNR-20D621K	20D621K	395	510	620	558	682	1020	100	220	6500	1	570	◇	
CNR-20D681K	20D681K	420	560	680	612	748	1120	100	230	6500	1	550	◇	
CNR-20D751K	20D751K	465	615	750	675	825	1235	100	255	6500	1	530	◇	
CNR-20D781K	20D781K	485	640	780	702	858	1290	100	265	6500	1	500	◇	
CNR-20D821K	20D821K	510	670	820	738	902	1355	100	282	6500	1	500	◇	
CNR-20D911K	20D911K	550	745	910	819	1001	1500	100	310	6500	1	480	◇	
CNR-20D102K	20D102K	625	825	1000	900	1100	1650	100	342	6500	1	460	◇	
CNR-20D112K	20D112K	680	895	1100	990	1210	1815	100	383	6500	1	400	◇	
CNR-20D182K	20D182K	1000	1465	1800	1620	1980	2950	100	620	6500	1	300	3	○

Related Standards

Symbols	○	□	◇					
Approval								

Reliability

Characteristics	Standard	Test Conditions	Specifications
Robustness of terminations	IEC 60068-2-21 Test Ua1	F = 10 N (d ≤ 0.8 mm) , F = 20 N (d = 1 mm)	$\Delta V/V \leq \pm 10\%$ No visible damage
Solderability	IEC 60068-2-20 Test Ta (Method 1)	T = 235±5°C, d = 2±0.5s	Approximately ≥ 95%
Resistance to soldering heat	IEC 60068-2-20 Test Tb (Method 1A)	T = 260±5°C, d = 10±1s	$\Delta V/V \leq \pm 10\%$ No visible damage
Shock	IEC 60068-2-27 Test Ea	Pulse shape: half-sine. a = 490 m/s ² , d = 11ms. N = 6 x 3 shocks	$\Delta V/V \leq \pm 10\%$ No visible damage
Vibration	IEC 60068-2-6 Test Fc Method B4	Frequency range: 10 Hz to 55 Hz ,a = 0.75 mm or 98 m/s ² (whichever is the less), d = 3x2 h	$\Delta V/V \leq \pm 10\%$ No visible damage
Needle flame test	IEC 60695-11-5	Severity: Vertical 10 s	Duration of burning: 5 s max.
Voltage under pulse condition	IEC 61051-2	At class current	As specified in specification
Voltage proof	IEC 61051-2	Metal balls method (4.8.1.2) 2500 V, 60 s	As specified in specification
Pulse current - 8/20 μs	IEC 61051-2	8/20 μs, 10 times, I peak=0.25*Imax	$\Delta V/V \leq \pm 10\%$ No visible damage
Pulse current - 10/1000 μs	IEC 61051-2	10/1000 μs, 10 times, Ipeak = 0.0075* Imax	$\Delta V/V \leq \pm 10\%$ No visible damage
Combination pulse	IEC 60950-1:2013 Annex Q	Additional test: 10 pulses (combination pulse 6KV/3KA), in one direction, 1 per min	$\Delta V/V \leq \pm 10\%$ No visible damage U ≤ 1.1 Uinitial Voltage proof:No breakdown or flashover
Rapid change of temperature	IEC 60068-2-14 Test Na	N = 5 cycles, d = 30 min , θA = -40±3°C, θB = 85±2°C	$\Delta V/V \leq \pm 10\%$ No visible damage
Climatic sequence	IEC 60068-2-2 Test Ba IEC 60068-2-30 Test Db IEC 60068-2-1 Test Aa IEC 60068-2-30 Test Db	Dry heat, Test Ba:16±2h, T = 85±2°C Damp heat, Test Db first cycle :24h, T = 55±2°C Cold, Test Aa :2h, T = -40±3°C Damp heat Test Ba remaining cycles:5 cycle	$\Delta V/V \leq \pm 10\%$ No visible damage RISO ≥ 100MΩ Voltage proof:No breakdown or flashover
Endurance at upper category temperature	IEC 61051-1 (4.21)	T:max temperature as specified , Duration: 1000 h, Voltage: max. a.c. voltage	$\Delta V/V \leq \pm 10\%$ No visible damage R ≥ 1000MΩ U ≤ 1,1 Uinitial



Reliability

Characteristics	Standard	Test Conditions	Specifications
Damp heat (Steady state)	IEC 60068-2-78 Test Ca	T = 40±2°C, RH = 93(+2/-3)%, 56d , 4 specimens:No voltage applied , Other 4 specimens:Applied voltage: 10% of the max. d.c. voltage	$\Delta V/V \leq \pm 10\%$ RISO $\geq 100M\Omega$
Maximum Peak Current	Specification Standard	$I_{max}, 8/20 \mu s, 1 \text{ time } \frac{V_{1mA \text{ at } 85^\circ C} - V_{1mA \text{ at } 25^\circ C}}{V_{1mA \text{ at } 25^\circ C}} \times \frac{1}{60} \times 100(\%/C)$	$-0.05 \leq TC \leq 0.05(\%/C)$
Nominal Discharge Current Test	UL1449 4th	Nominal Discharge Current (In), 8/20 μs , 15 times	$\Delta V/V \leq \pm 10\%$ No visible damage
Varistor Voltage Temp. Coefficient	Specification Standard	V1mA at -40°C, 85°C, 25°C	$\Delta V/V \leq \pm 10\%$ No visible damage
High Temperature Storage	IEC60068-2-2	1000h, T = 85±2°C	$\Delta V/V \leq \pm 10\%$ No visible damage
Max. Energy	Specification Standard	10/1000 μs , 1 tmes, Max. Energy	$\Delta V/V \leq \pm 10\%$ No visible damage
Operating duty cycle test *	UL 1449	6 kV/3 kA combination wave surges, phase angle of 90 (+0, -15) degrees, npositive polarity 8 times, negative polarity 7 times, interval of 60s.	$\Delta V/V \leq \pm 10\%$ No visible damage
Surge Immunity Test *	IEC 61000-4-5	4kV/2kA combination wave surges, phase angle of 90 (+0, -15) degrees, npositive polarity 20times, negative polarity 20times, interval of 60s.	$\Delta V/V \leq \pm 10\%$ No visible damage

* (According to customer requirements to meet the test items)

Impulse Life Time Rating Curves

CNR-05D180K to CNR-05D680K

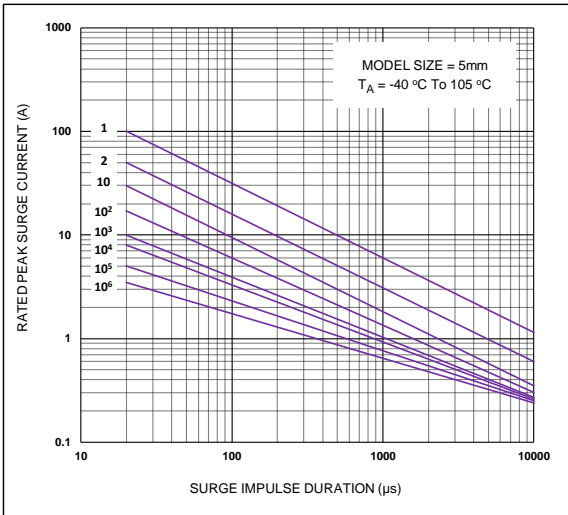

CNR-05D820K to CNR-05D751K



CNR-07D180K to CNR-07D680K

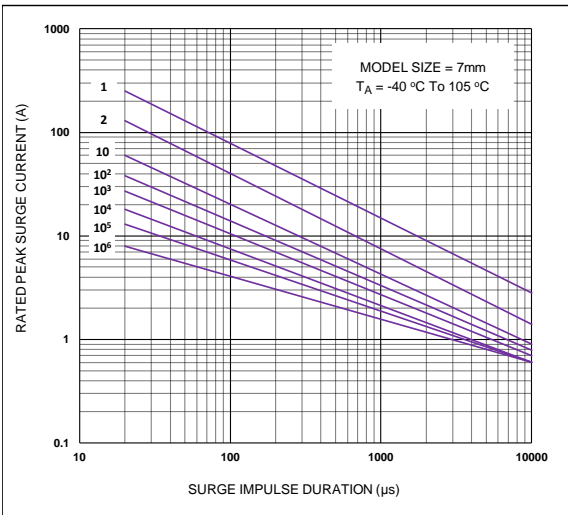

CNR-07D820K to CNR-07D821K



Impulse Life Time Rating Curves

CNR-10D180K to CNR-10D680K

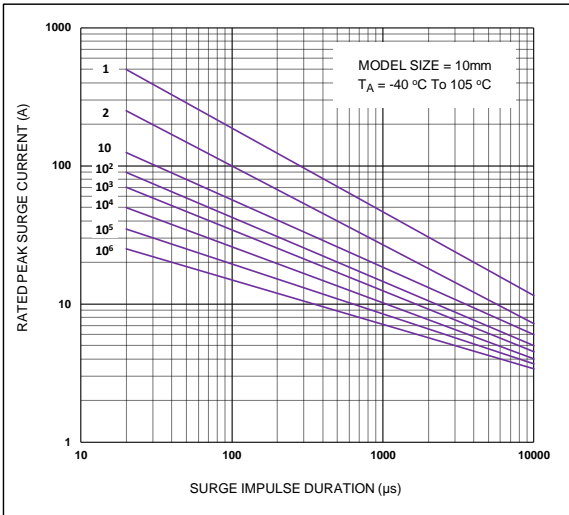

CNR-10D820K to CNR-10D751K

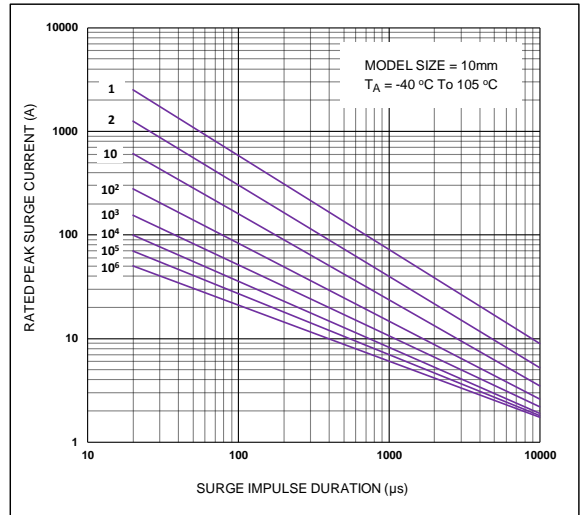

CNR-10D781K to CNR-10D182K

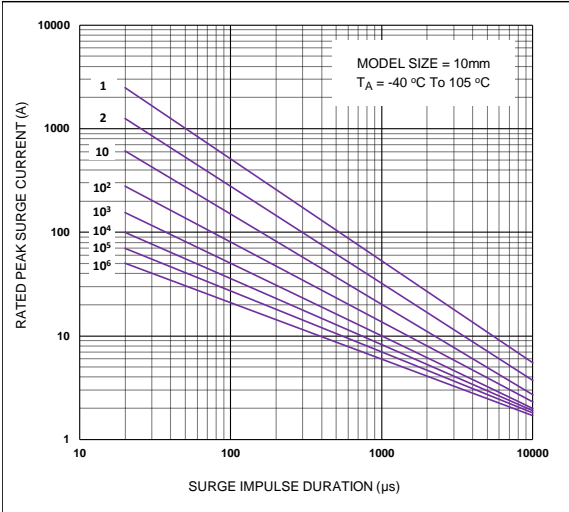

Impulse Life Time Rating Curves

CNR-14D180K to CNR-14D680K

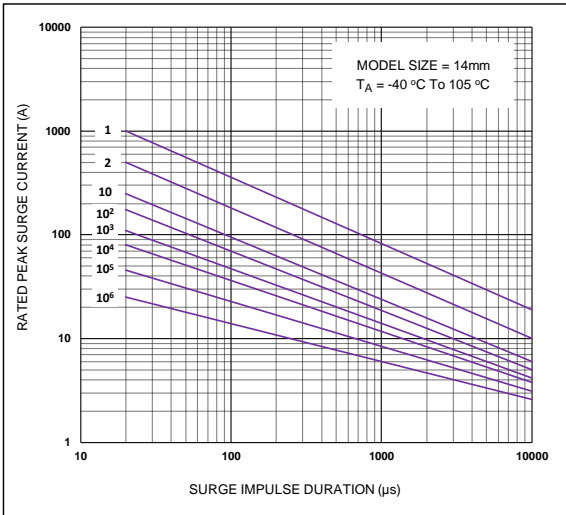

CNR-14D820K to CNR-14D751K

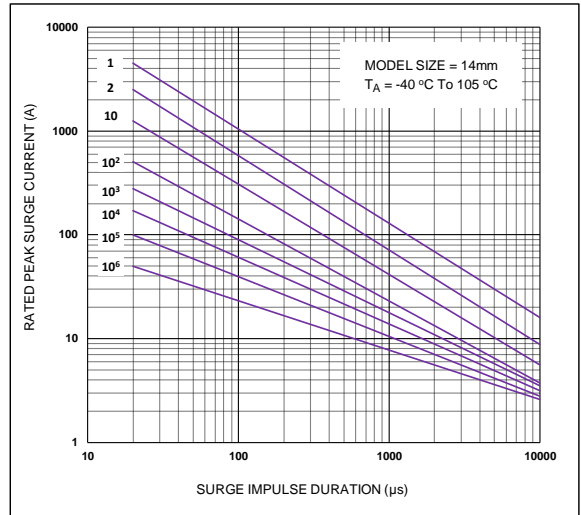

CNR-14D781K to CNR-14D182K

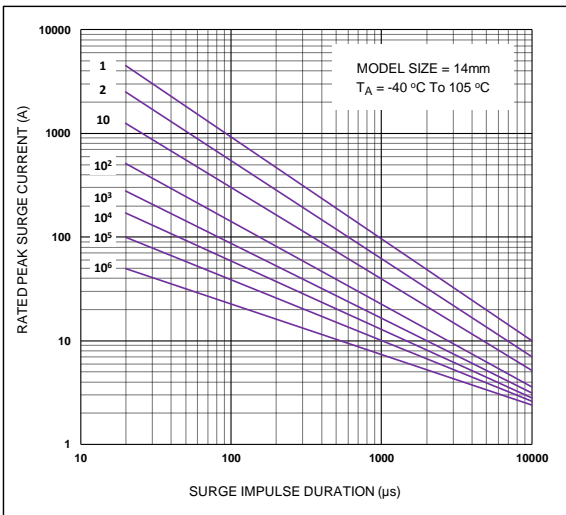

Impulse Life Time Rating Curves

CNR-18D180K to CNR-18D680K

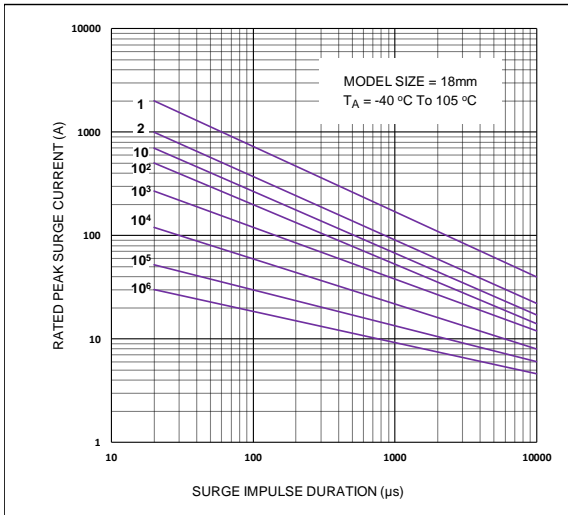

CNR-18D820K to CNR-18D751K

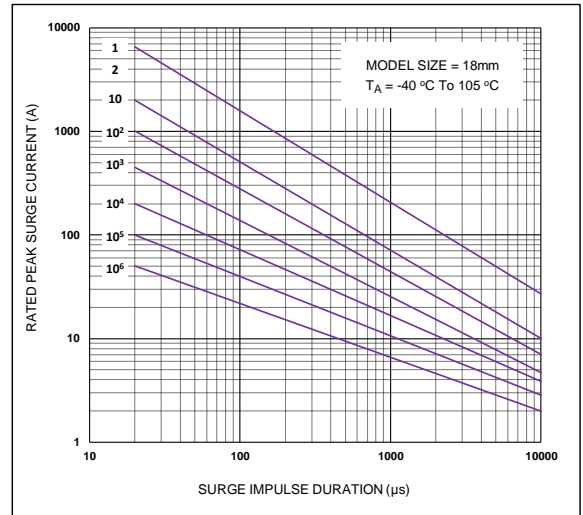

CNR-18D781K to CNR-18D112K

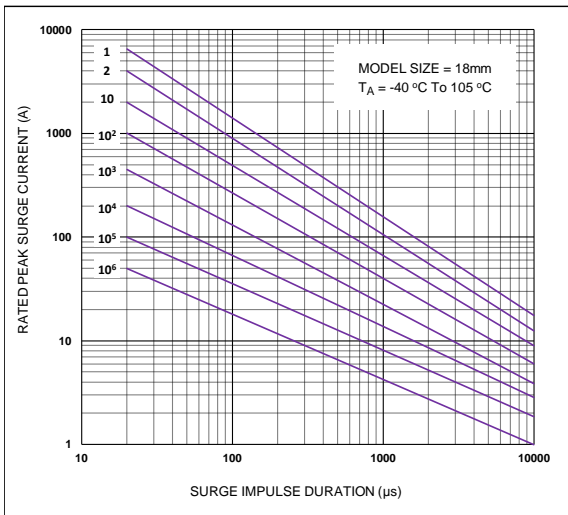

Impulse Life Time Rating Curves

CNR-20D180K to CNR-20D680K



CNR-20D820K to CNR-20D751K



CNR-20D781K to CNR-20D182K



CNR-05D180K to CNR-05D680K V-I Curves

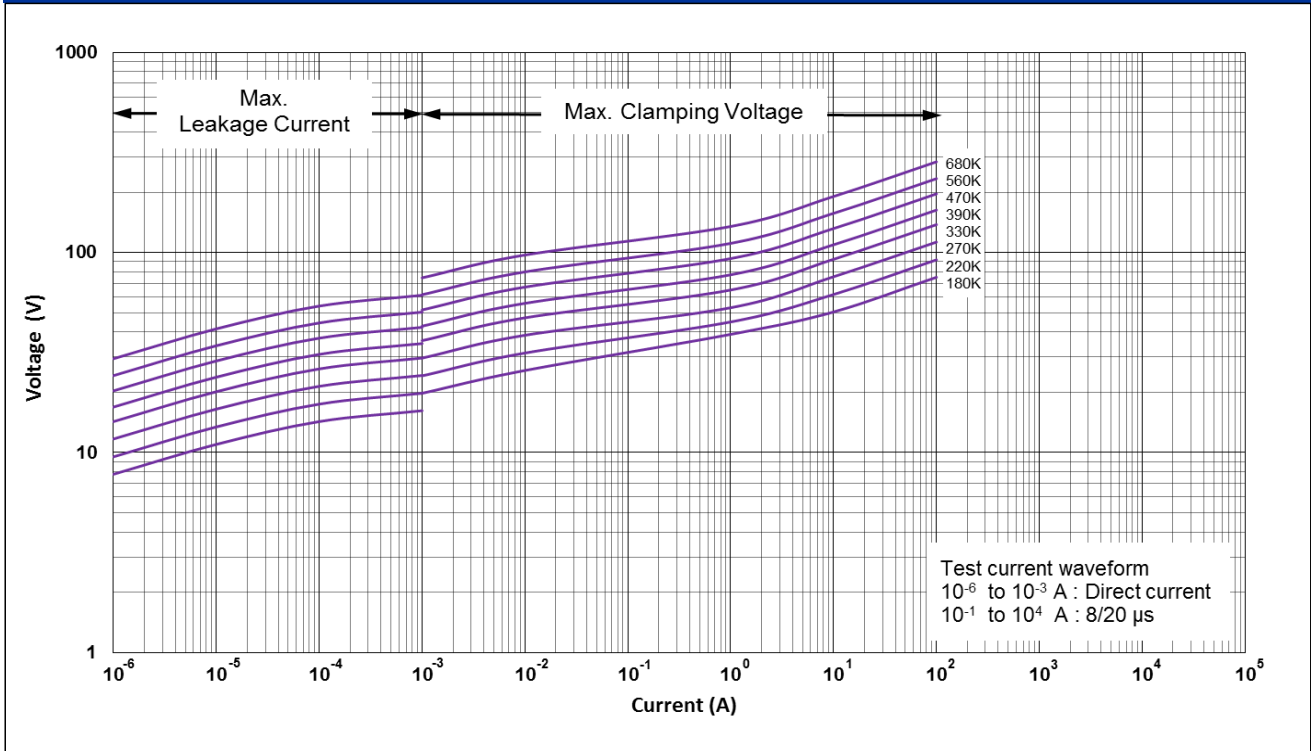

CNR-05D820K to CNR-05D751K V-I Curves

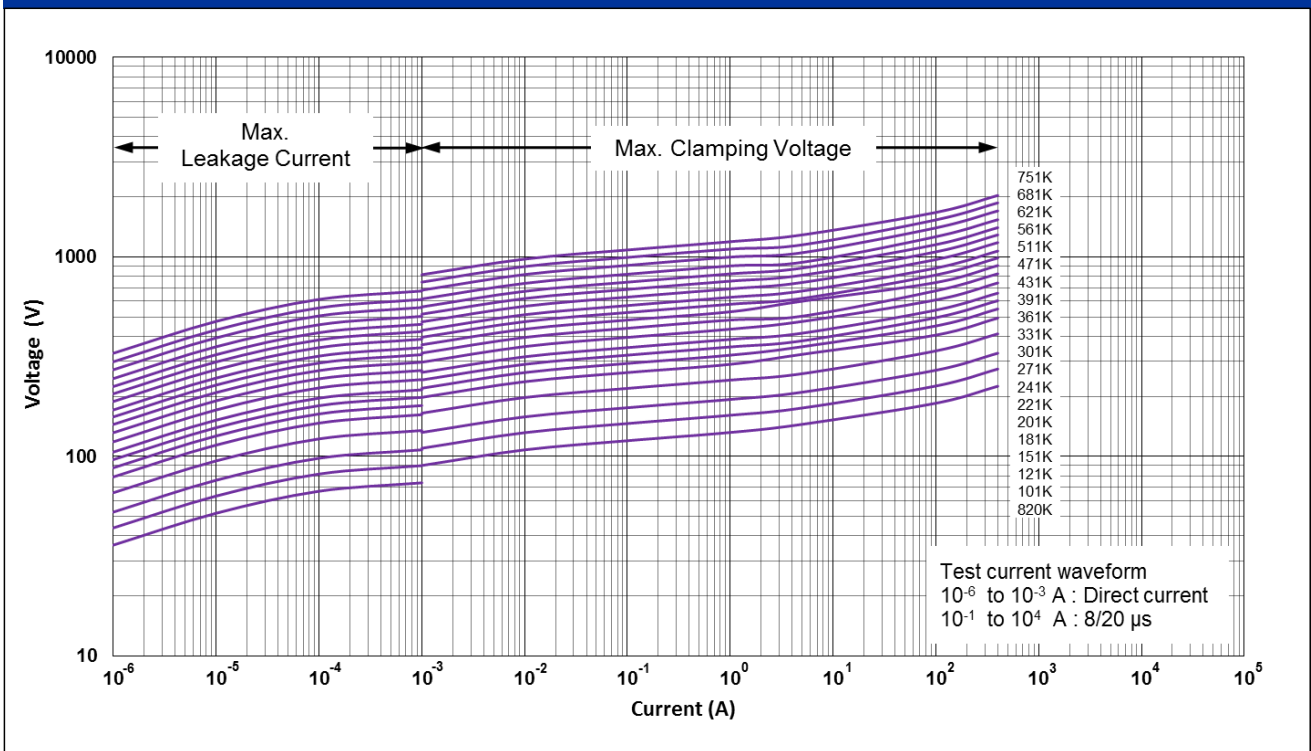

CNR-07D180K to CNR-07D680K V-I Curves

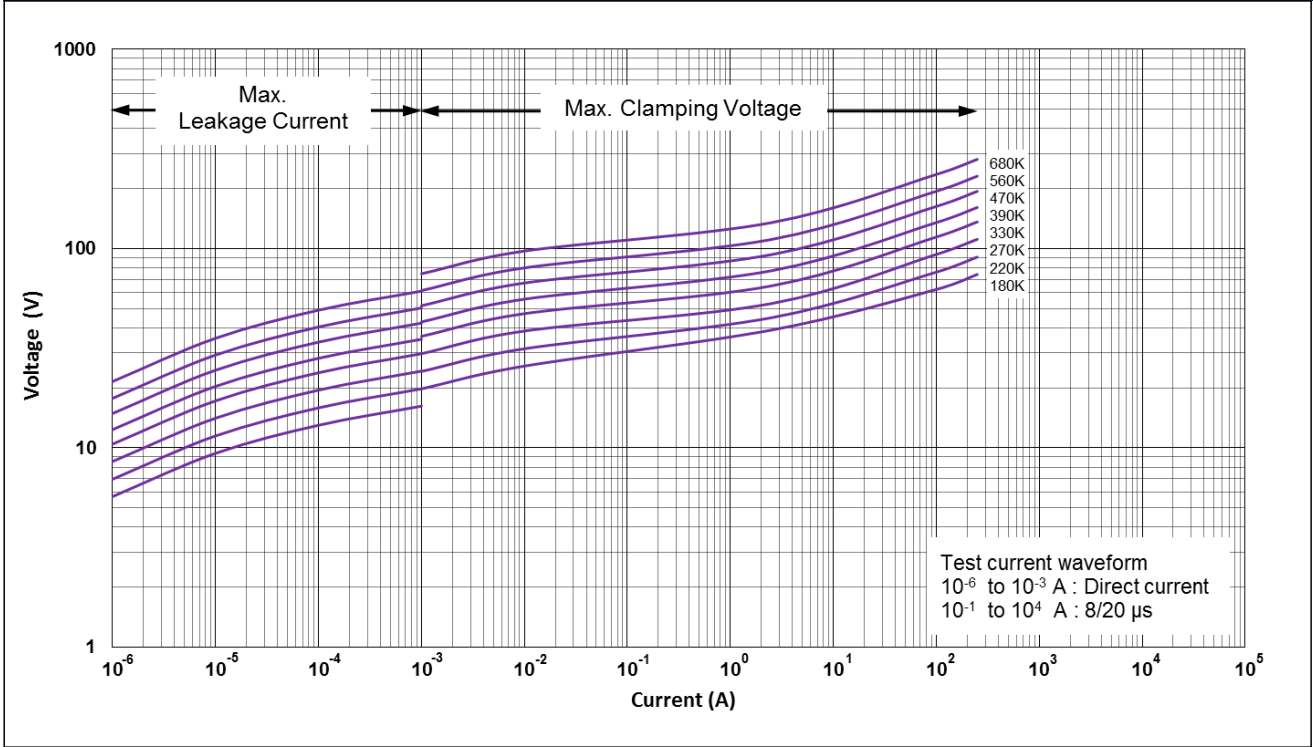

CNR-07D820K to CNR-07D821K V-I Curves

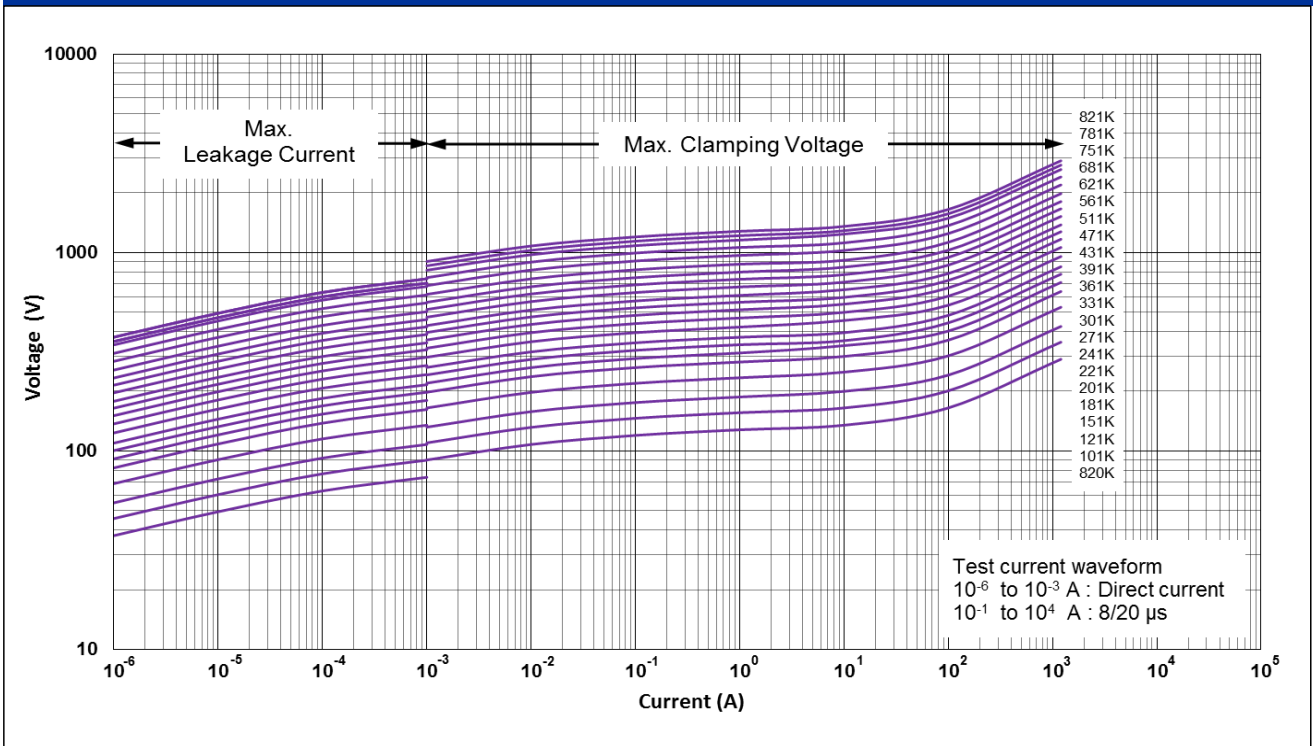

CNR-10D180K to CNR-10D680K V-I Curves



CNR-10D820K to CNR-10D471K V-I Curves



CNR-10D511K to CNR-10D182K V-I Curves

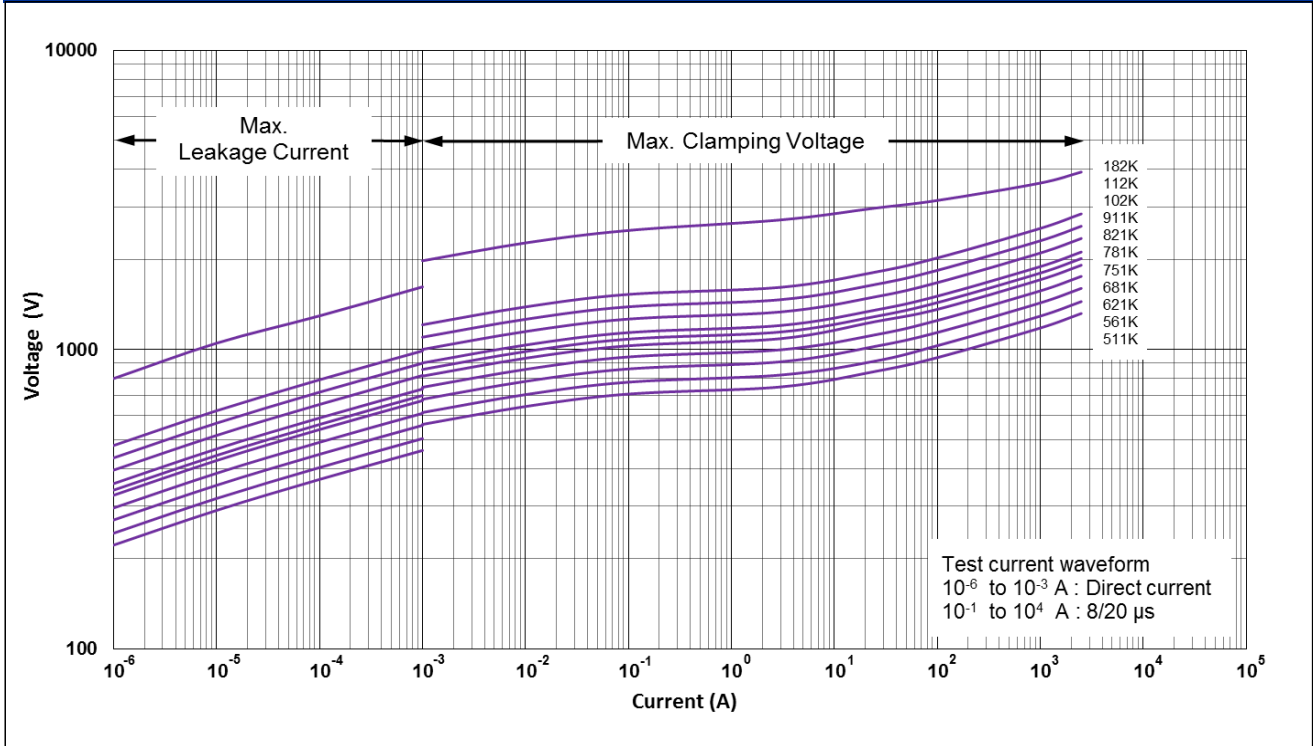

CNR-14D180K to CNR-14D680K V-I Curves

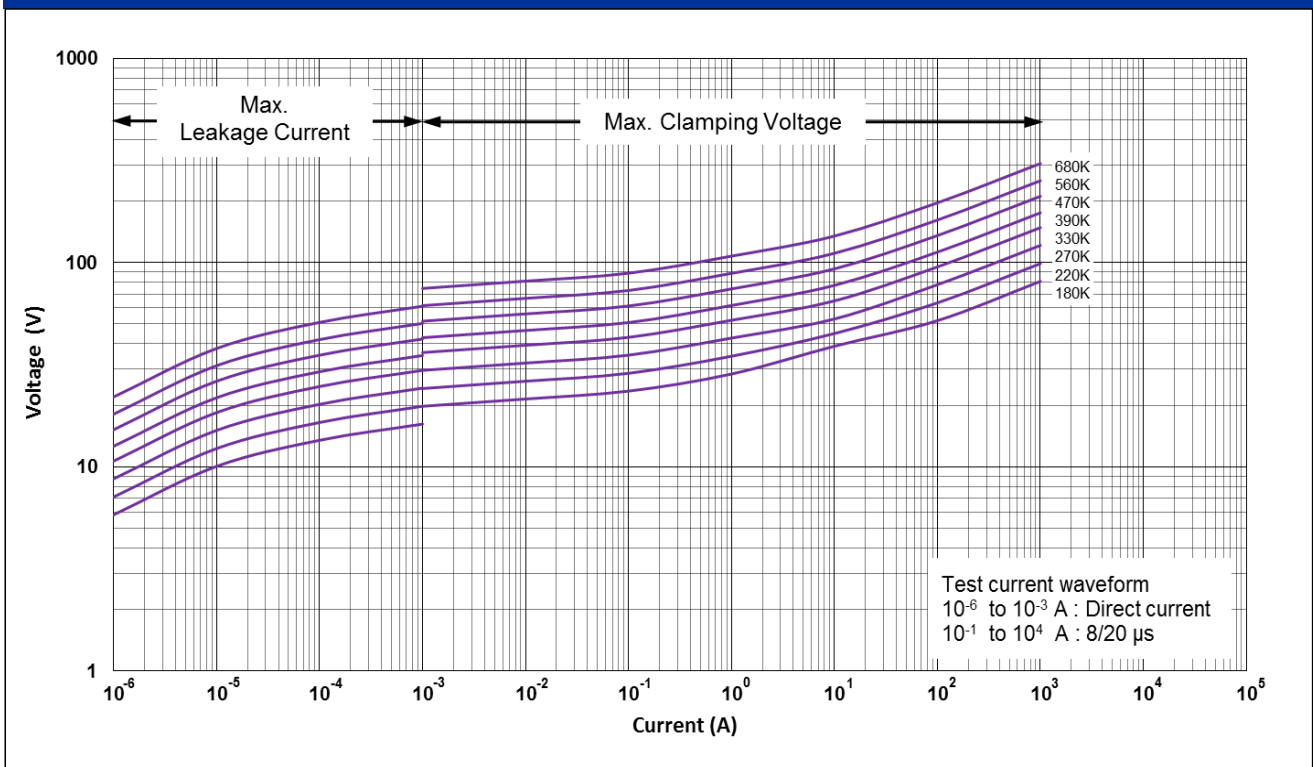

CNR-14D820K to CNR-14D471K V-I Curves

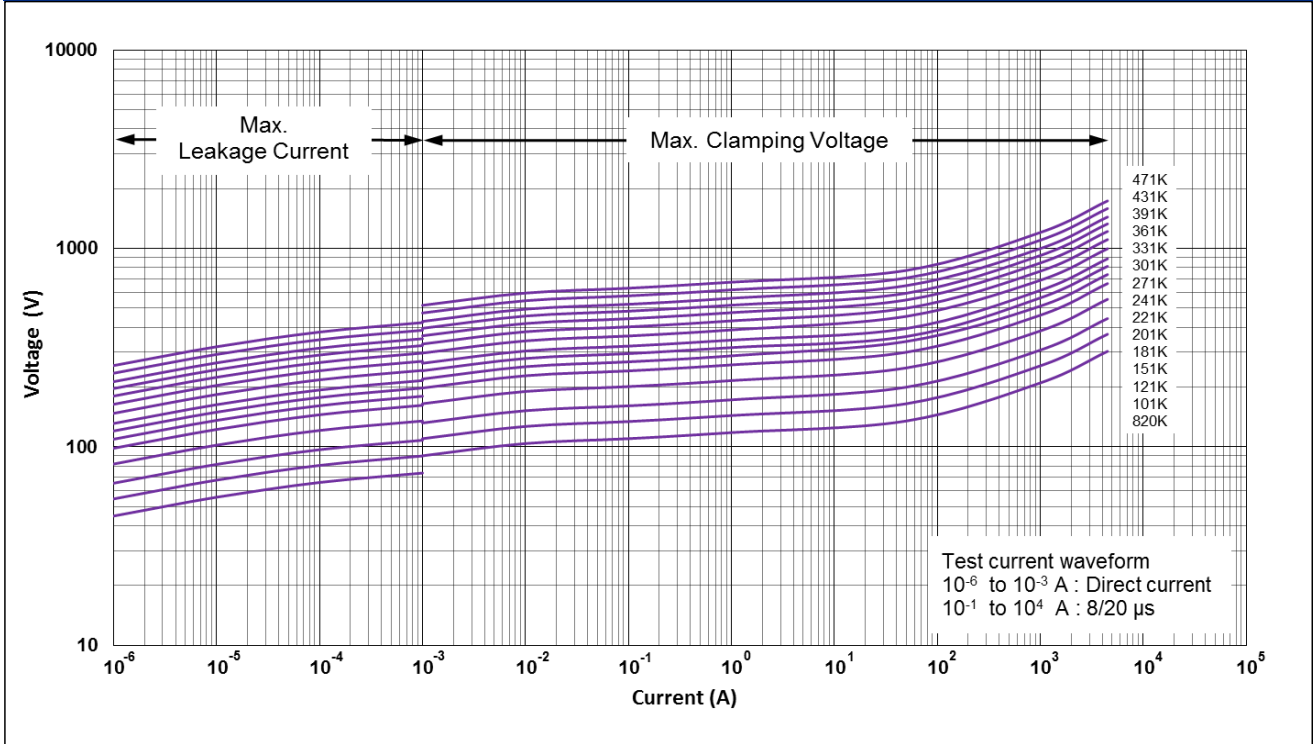

CNR-14D511K to CNR-14D182K V-I Curves

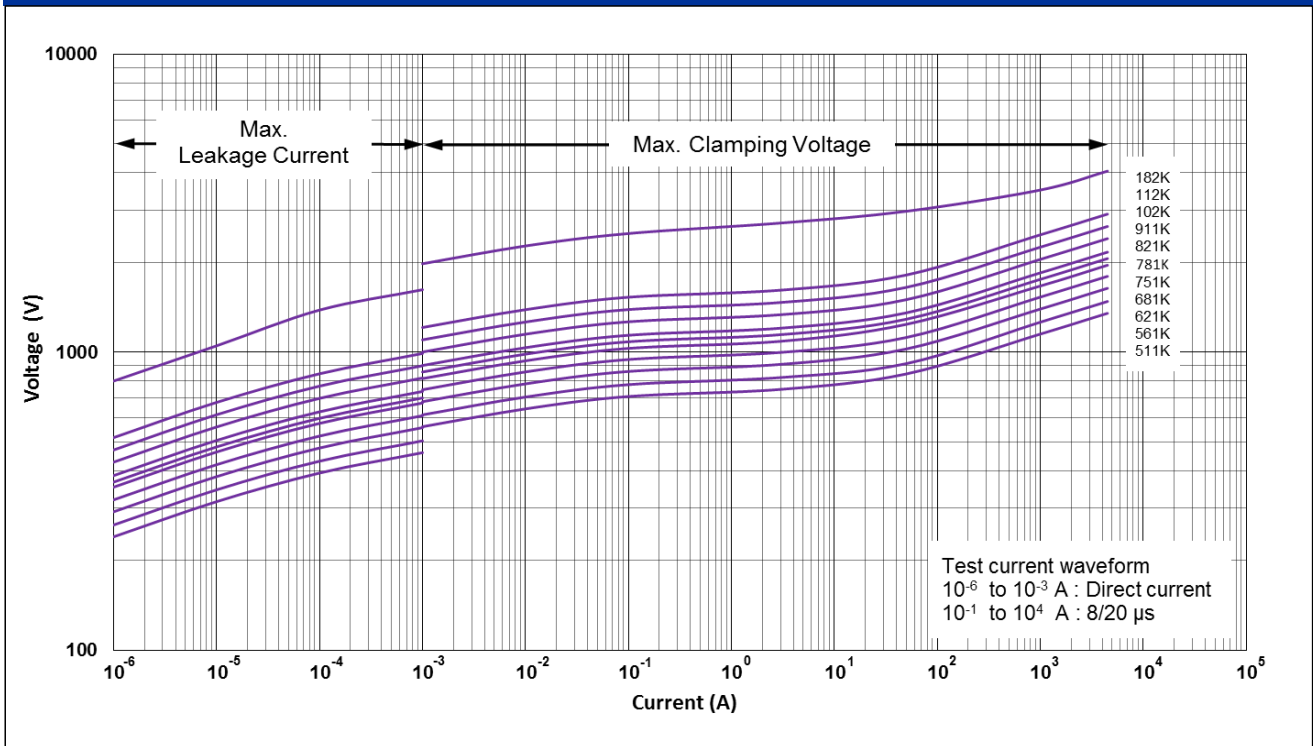

CNR-18D180K to CNR-18D680K V-I Curves

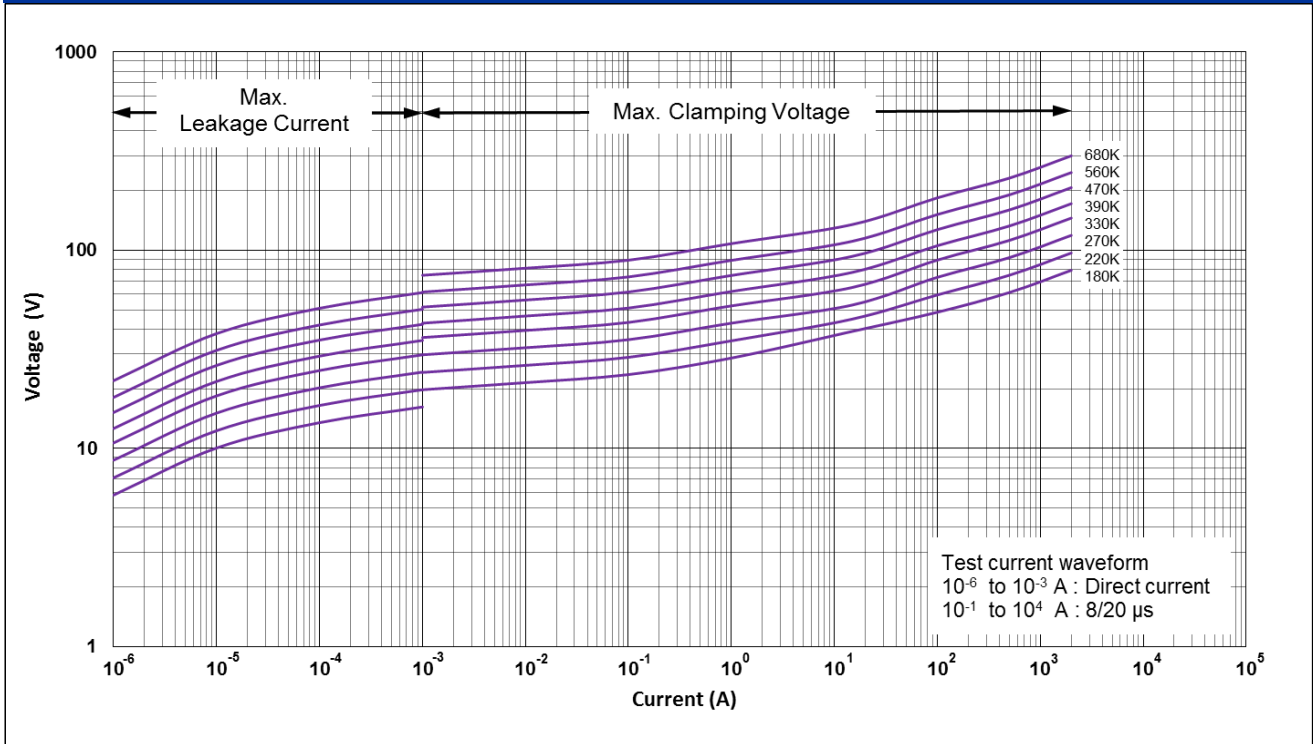

CNR-18D820K to CNR-18D471K V-I Curves

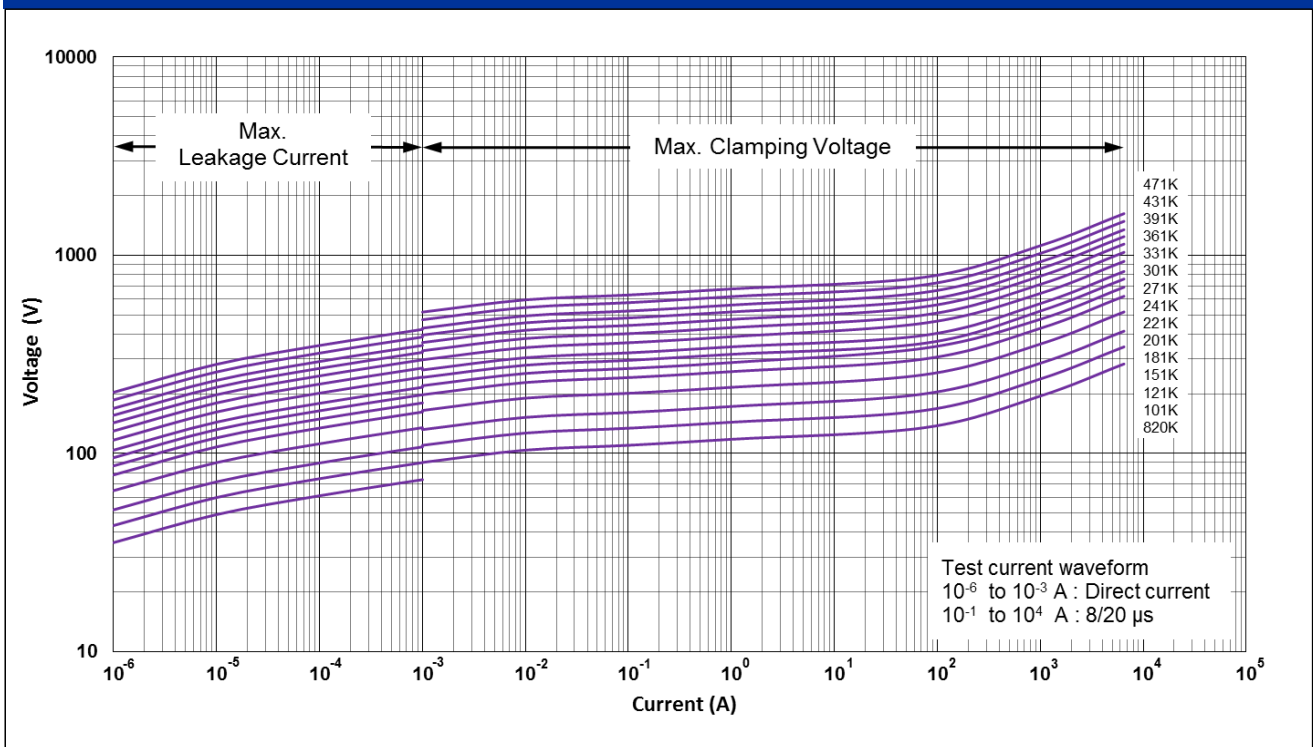

CNR-18D511K to CNR-18D112K V-I Curves

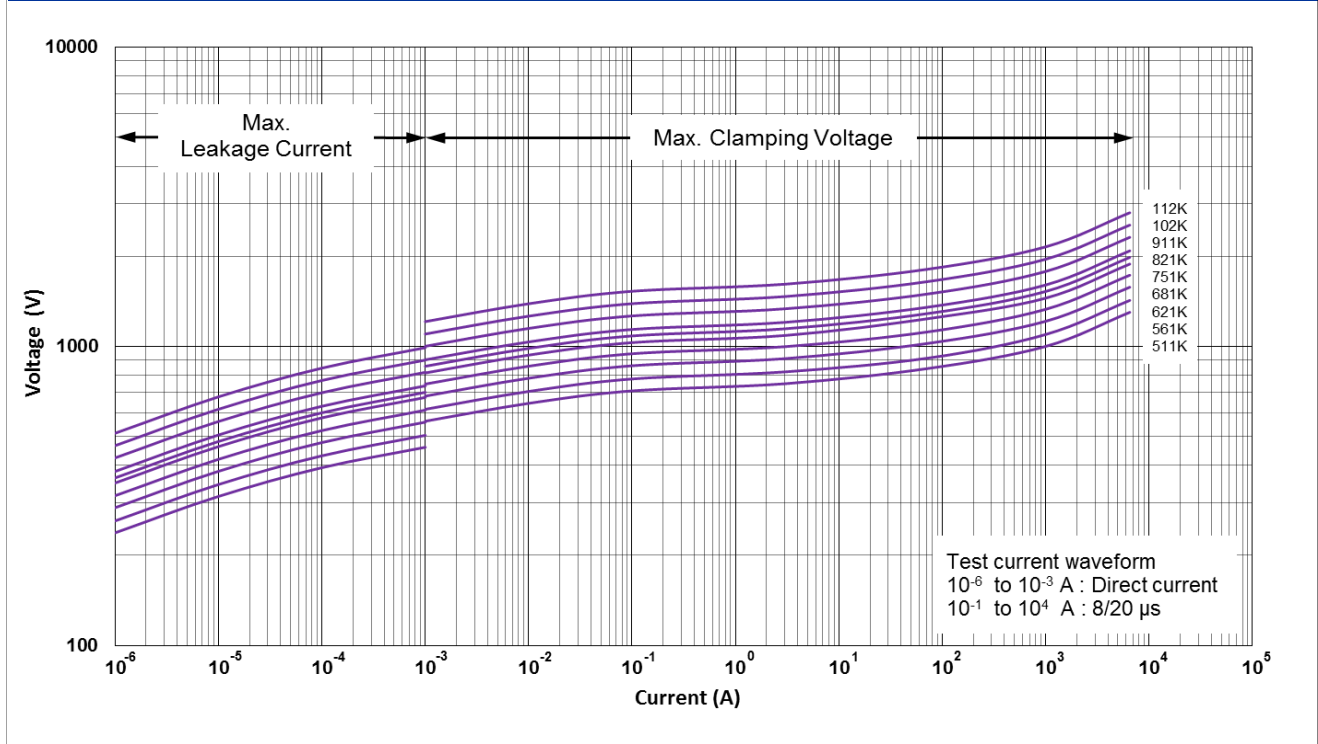

CNR-20D180K to CNR-20D680K V-I Curves

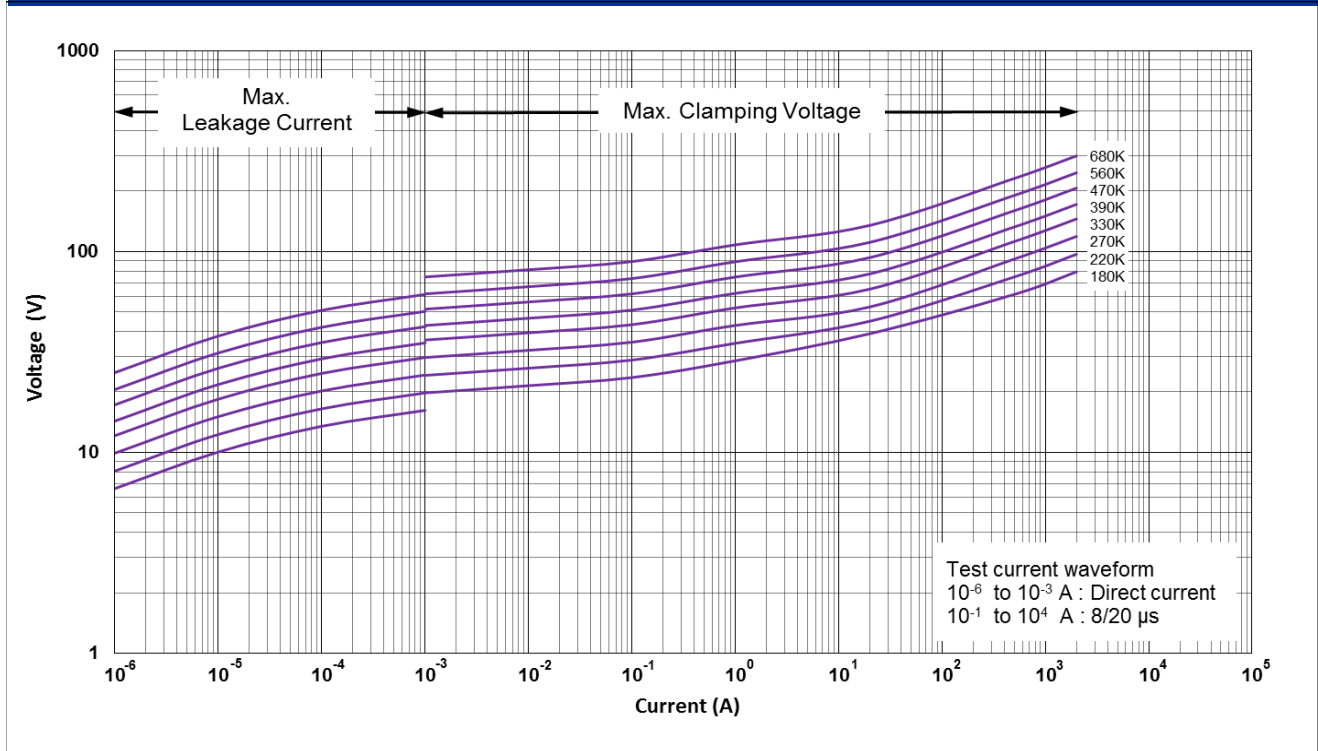

CNR-20D820K to CNR-20D471K V-I Curves

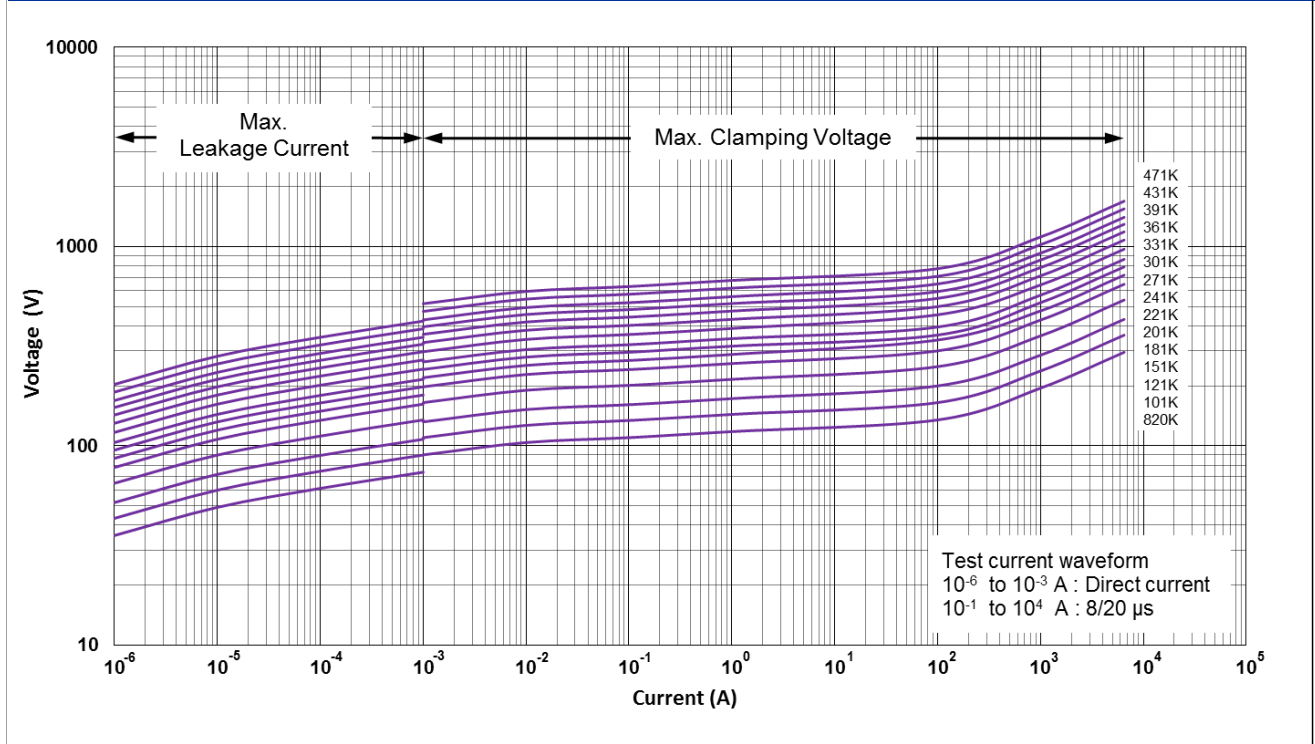

CNR-20D511K to CNR-20D182K V-I Curves

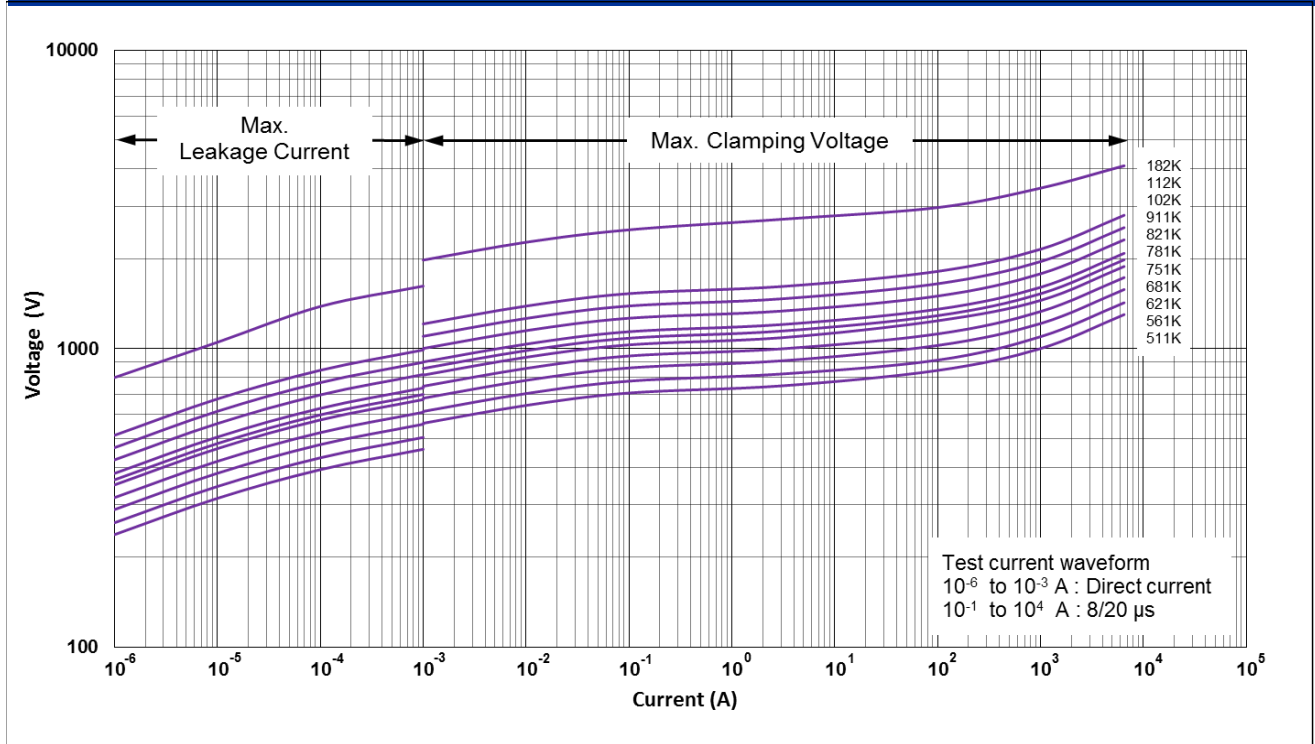

Power Derating Curve

Should transients occur in rapid succession, the average power dissipation is the energy (watt-seconds) per pulse times the number of pulses per second. The power so developed must be with the specifications shown on the Device Ratings and Specifications Table for the specific device. The operating values of a MOV need to be derated at high temperatures as shown above. Because varistors only dissipate a relatively small amount of average power they are not suitable for repetitive applications that involve substantial amounts of average power dissipation.

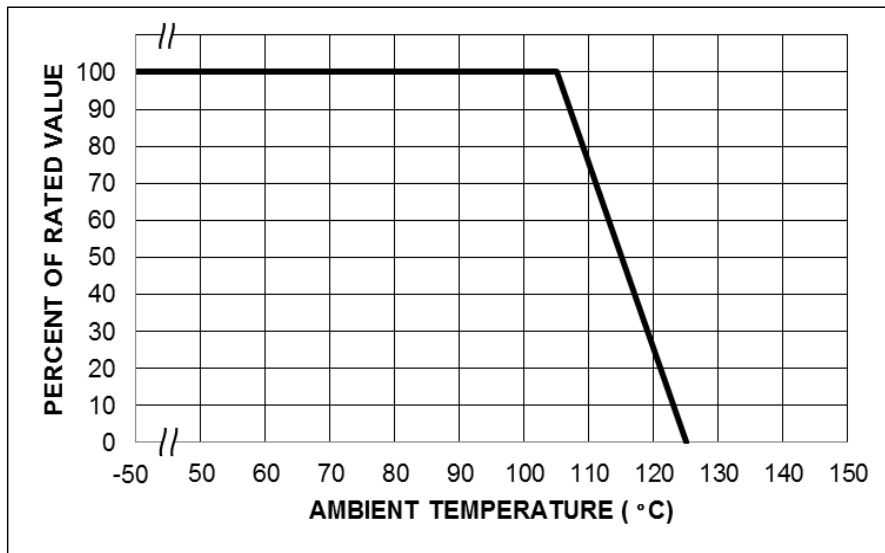

Surge Current Standard Waveform



O1 = Virtual Origin of Wave
 T = Time from 10% to 90% of Peak
 T1 = Rise Time = 1.25 x T
 T2 = Decay Time
 Example - For an 8/20 μ s Current Waveform:
 8 μ s = T1 = Rise Time
 20 μ s = T2 = Decay Time

Product Dimensions

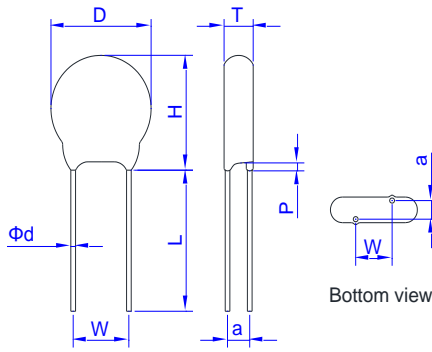

Fig 1. Straight Lead



Fig 2. Outside Kink Lead

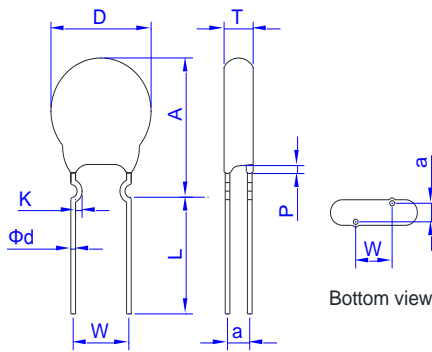

Fig 3. Inside Kink Lead

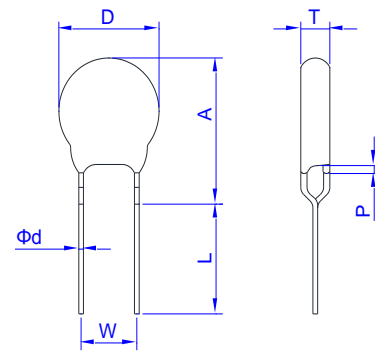

Fig 4. In Line Kink Lead

Dimension Table

Unit:mm

Symbol	Model size	05D		07D		10D		14D		18D		20D	
		Min.	Max.	Min.	Max.	Min.	Max.	Min.	Max.	Min.	Max.	Min.	Max.
D		5.5	7.5	7.5	9.0	10.5	14.0	13.5	17.5	18.5	23.0	19.5	25.0
H		-	10.0	-	12.0	-	17.0	-	20.5	-	26.0	-	28.0
W		4.0	6.0	4.0	6.0	6.5	8.5	6.5	8.5	6.5	8.5	9.0	11.0
Φd		0.55	0.65	0.55	0.65	0.75	0.85	0.75	0.85	0.75	0.85	0.95	1.05
P(max.)		3.0											
L(min)		25.0											
K(Kink Lead)		0.8	1.6	0.8	1.6	1.0	1.8	1.0	1.8	1.0	1.8	1.0	1.8
A(max.)	180K-271K	-	13.0	-	15.0	-	19.5	-	22.5	-	26.5	-	30.0
	>271K	-	13.0	-	15.0	-	20.5	-	23.5	-	27.0	-	31.0
T		See Tmax table											

* Short Cut Lead type TTX the lead length (L) can 3.0~15mm (expect 20D dia <10mm), see Ordering Note.

** a value see T max. table

T max. Table								Unit:mm							
Model	05D	07D	10D	14D	18D	20D	a(±1.0)	Model	05D	07D	10D	14D	18D	20D	a(±1.0)
180K	3.3	3.5	3.9	4.0	4.2	4.3	1.5	301K	3.9	4.1	4.3	4.4	4.6	4.7	1.9
220K	3.6	3.8	4.2	4.3	4.5	4.6	1.6	331K	4.0	4.2	4.5	4.6	4.8	4.9	2.0
270K	3.8	4.0	4.4	4.5	4.7	4.8	1.7	361K	4.1	4.3	4.7	4.8	5.0	5.1	1.7
330K	3.3	3.5	3.9	4.0	4.2	4.3	1.6	391K	4.2	4.4	4.8	4.9	5.1	5.2	1.8
390K	3.5	3.7	4.1	4.2	4.4	4.5	1.8	431K	4.4	4.6	5.0	5.1	5.3	5.4	1.9
470K	3.7	3.9	4.3	4.4	4.6	4.7	1.9	471K	4.6	4.8	5.2	5.3	5.5	5.6	2.0
560K	4.0	4.2	4.6	4.7	4.9	5.0	2.0	511K	4.8	5.0	5.3	5.4	5.6	5.7	2.2
680K	4.3	4.5	4.9	5.0	5.2	5.3	2.2	561K	5.0	5.2	5.5	5.6	5.8	5.9	2.3
820K	3.3	3.5	3.9	4.0	4.2	4.3	1.5	621K	5.3	5.5	5.7	5.8	6.0	6.1	2.5
101K	3.6	3.8	4.2	4.3	4.5	4.6	1.5	681K	5.4	5.6	5.8	5.9	6.1	6.2	2.7
121K	3.8	4.0	4.4	4.5	4.7	4.8	1.6	751K	5.6	5.8	6.0	6.1	6.3	6.4	2.9
151K	4.1	4.3	4.7	4.8	5.0	5.1	1.8	781K	-	6.0	6.3	6.4	6.6	6.7	3.0
181K	3.2	3.4	3.8	3.9	4.1	4.2	1.5	821K	-	6.3	6.5	6.6	6.8	6.9	3.1
201K	3.3	3.5	3.9	4.0	4.2	4.3	1.5	911K	-	-	6.6	6.7	6.9	7.0	3.5
221K	3.4	3.6	4.0	4.1	4.3	4.4	1.6	102K	-	-	7.0	7.1	7.3	7.4	3.8
241K	3.5	3.7	4.1	4.2	4.4	4.5	1.7	112K	-	-	7.4	7.5	7.7	7.9	4.1
271K	3.7	3.9	4.2	4.3	4.5	4.6	1.8	182K	-	-	11.3	11.5	-	11.9	6.0

Tape and Reel Specifications

● Radial devices on tape are supplied with straight leads or inline kink leads.



Straight Leads

Figure: A

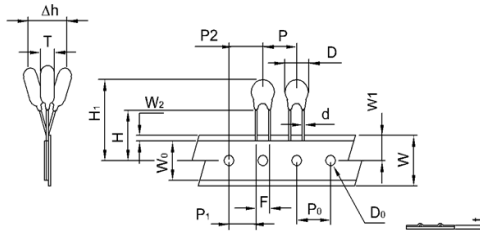

Figure: B

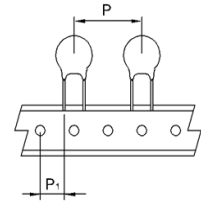
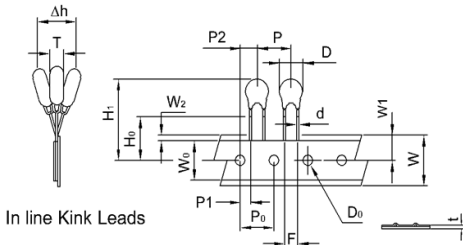

Figure: C



In line Kink Leads

Figure: D

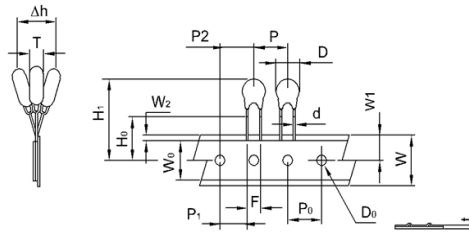

Figure: E

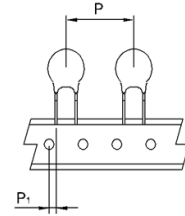

Figure: F

Symbol	Description	Model					
		05D	07D	10D	10D	14D	14D
P	Pitch of Component	12.7±1.0	12.7±1.0	12.7±1.0	15.0±1.0	25.4±1.0	30.0±1.0
P ₀	Feed Hole Pitch	12.7±0.2	12.7±0.2	12.7±0.2	15.0±0.2	12.7±0.2	15.0±0.2
P ₁	Feed Hole Center to Pitch	3.85±0.7	3.85±0.7	3.85±0.7	3.75±0.7	8.95±0.7	3.75±0.7
P ₂	Hole Center to Component Center	6.35±0.7	6.35±0.7	6.35±0.7	7.5±0.7	12.7±0.7	7.5±0.7
F	Lead to Lead Distance	5.0±0.8	5.0±0.8	7.5±0.8	7.5±0.8	7.5±0.8	7.5±0.8
Δh	Component Alignment	2.0max	2.0max	2.0max	2.0max	2.0max	2.0max
W	Tape Width	18.0+1.0	18.0+1.0	18.0+1.0	18.0+1.0	18.0+1.0	18.0+1.0
		18.0-0.5	18.0-0.5	18.0-0.5	18.0-0.5	18.0-0.5	18.0-0.5
W ₀	Hold Down Tape Width	5.0 Min.	5.0 Min.	5.0 Min.	5.0 Min.	5.0 Min.	5.0 Min.
W ₁	Hole Position	9.0+0.75	9.0+0.75	9.0+0.75	9.0+0.75	9.0+0.75	9.0+0.75
		9.0-0.5	9.0-0.5	9.0-0.5	9.0-0.5	9.0-0.5	9.0-0.5
W ₂	Hold Down Tape Position	3.0 Max	3.0 Max	3.0 Max	3.0 Max	3.0 Max	3.0 Max
H	Height from Tape Center to Component Base	18.0+2.0	18.0+2.0	18.0+2.0	18.0+2.0	18.0+2.0	18.0+2.0
		18.0-0.0	18.0-0.0	18.0-0.0	18.0-0.0	18.0-0.0	18.0-0.0
H ₀	Seating Plane Height	16.0±0.5	16.0±0.5	16.0±0.5	16.0±0.5	16.0±0.5	16.0±0.5
H ₁	Component Height	29.0 Max.	32.0 Max.	36.0 Max.	36.0 Max.	40.0 Max.	40.0 Max.
D ₀	Feed Hole Diameter	4.0±0.2	4.0±0.2	4.0±0.2	4.0±0.2	4.0±0.2	4.0±0.2
t	Total Tape Thickness	0.7±0.2	0.7±0.2	0.7±0.2	0.7±0.2	0.7±0.2	0.7±0.2
L	Leagth Clipped Lead	11.0 Max	11.0 Max	11.0 Max	11.0 Max	11.0 Max	11.0 Max
Figure		A, D	A, D	B, E	A, D	C	F

Tape and Reel Specifications

● Radial devices on tape are supplied with inside kink leads or outside kink leads.

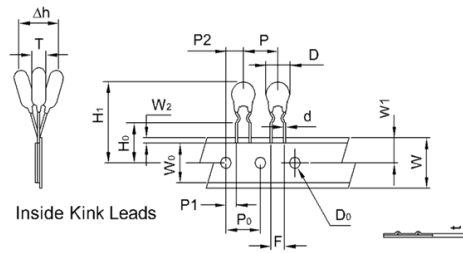

Figure: A

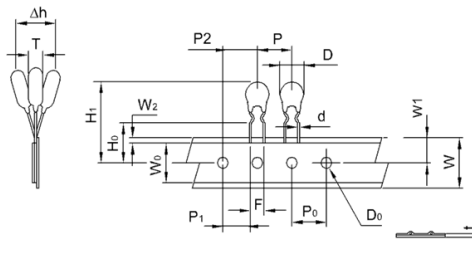

Figure: B

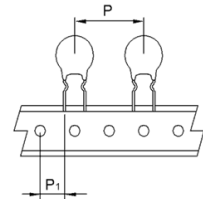

Figure: C

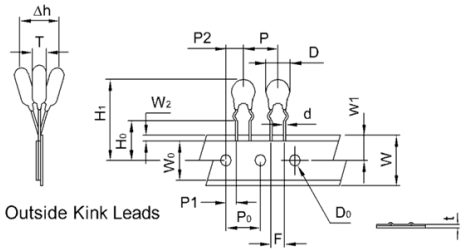

Figure: D

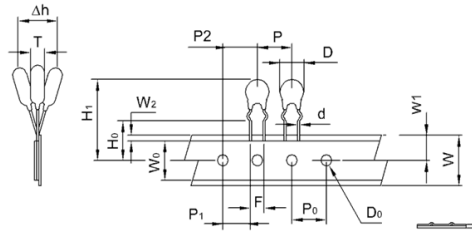

Figure: E

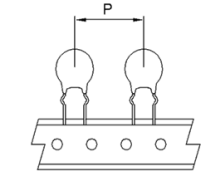

Figure: F

Symbol	Description	Model					
		05D	07D	10D	10D	14D	14D
P	Pitch of Component	12.7±1.0	12.7±1.0	12.7±1.0	15.0±1.0	25.4±1.0	30.0±1.0
P ₀	Feed Hole Pitch	12.7±0.2	12.7±0.2	12.7±0.2	15.0±0.2	12.7±0.2	15.0±0.2
P ₁	Feed Hole Center to Pitch	3.85±0.7	3.85±0.7	3.85±0.7	3.75±0.7	8.95±0.7	3.75±0.7
P ₂	Hole Center to Component Center	6.35±0.7	6.35±0.7	6.35±0.7	7.5±0.7	12.7±0.7	7.5±0.7
F	Lead to Lead Distance	5.0±0.8	5.0±0.8	7.5±0.8	7.5±0.8	7.5±0.8	7.5±0.8
Δh	Component Alignment	2.0max	2.0max	2.0max	2.0max	2.0max	2.0max
W	Tape Width	18.0+1.0	18.0+1.0	18.0+1.0	18.0+1.0	18.0+1.0	18.0+1.0
		18.0-0.5	18.0-0.5	18.0-0.5	18.0-0.5	18.0-0.5	18.0-0.5
W ₀	Hold Down Tape Width	5.0 Min.	5.0 Min.	5.0 Min.	5.0 Min.	5.0 Min.	5.0 Min.
W ₁	Hole Position	9.0+0.75	9.0+0.75	9.0+0.75	9.0+0.75	9.0+0.75	9.0+0.75
		9.0-0.5	9.0-0.5	9.0-0.5	9.0-0.5	9.0-0.5	9.0-0.5
W ₂	Hold Down Tape Position	3.0 Max	3.0 Max	3.0 Max	3.0 Max	3.0 Max	3.0 Max
H	Height from Tape Center to Component Base	18.0+2.0	18.0+2.0	18.0+2.0	18.0+2.0	18.0+2.0	18.0+2.0
		18.0-0.0	18.0-0.0	18.0-0.0	18.0-0.0	18.0-0.0	18.0-0.0
H ₀	Seating Plane Height	16.0±0.5	16.0±0.5	16.0±0.5	16.0±0.5	16.0±0.5	16.0±0.5
H ₁	Component Height	29.0 Max.	32.0 Max.	36.0 Max.	36.0 Max.	40.0 Max.	40.0 Max.
D ₀	Feed Hole Diameter	4.0±0.2	4.0±0.2	4.0±0.2	4.0±0.2	4.0±0.2	4.0±0.2
t	Total Tape Thickness	0.7±0.2	0.7±0.2	0.7±0.2	0.7±0.2	0.7±0.2	0.7±0.2
L	Leagth Clipped Lead	11.0 Max	11.0 Max	11.0 Max	11.0 Max	11.0 Max	11.0 Max
Figure		A, D	A, D	B, E	A, D	C	F

Packing information

Bulk packing

Series	Straight Lead Type Quantity(pcs/bag)	Cut Lead Type Quantity(pcs/bag)	Kink Type Quantity(pcs/bag)
CNR-05D	1000	1000	1000
CNR-07D	1000	1000	1000
CNR-10D	500	500	500
CNR-14D	500	500	500
CNR-18D	500	500	500
CNR-20D	250	250	250

Tape & Reel product packing

Series	A (mm)	Quantity (pcs/reel)
CNR-05D(180K~391K)-TRXX	43	2000
CNR-05D(431K~751K)-TRXX		1500
CNR-07D(180K~391K)-TRXX		2000
CNR-07D(431K~821K)-TRXX		1500
CNR-10D(180K~621K)-TRXX		1000
CNR-10D(681K~112K)-TRXX		800
CNR-14D(180K~391K)-TRXX	56	800
CNR-14(D431K~621K)-TRXX		700
CNR-14D(681K~112K)-TRXX		600

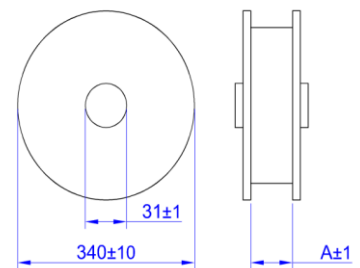

Box product packing

Series	Quantity (pcs/box)
CNR-05D(180K~621K)-BTXX	1000
CNR-05D(681K~751K)-BTXX	800
CNR-07D(180K~621K)-BTXX	1000
CNR-07D(681K~821K)-BTXX	800
CNR-10D(180K~621K)-BTXX	1000
CNR-10D(681K~112K)-BTXX	800
CNR-14D(180K~621K)-BTXX	500
CNR-14D(681K~112K)-BTXX	400

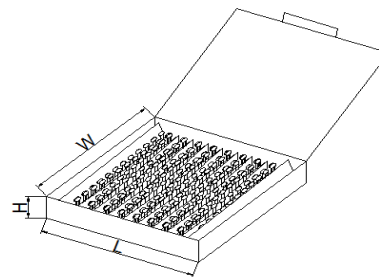

Series	L±5	W±5	H±5
CNR-05~07D	340	245	45
CNR-10~14D	340	245	50

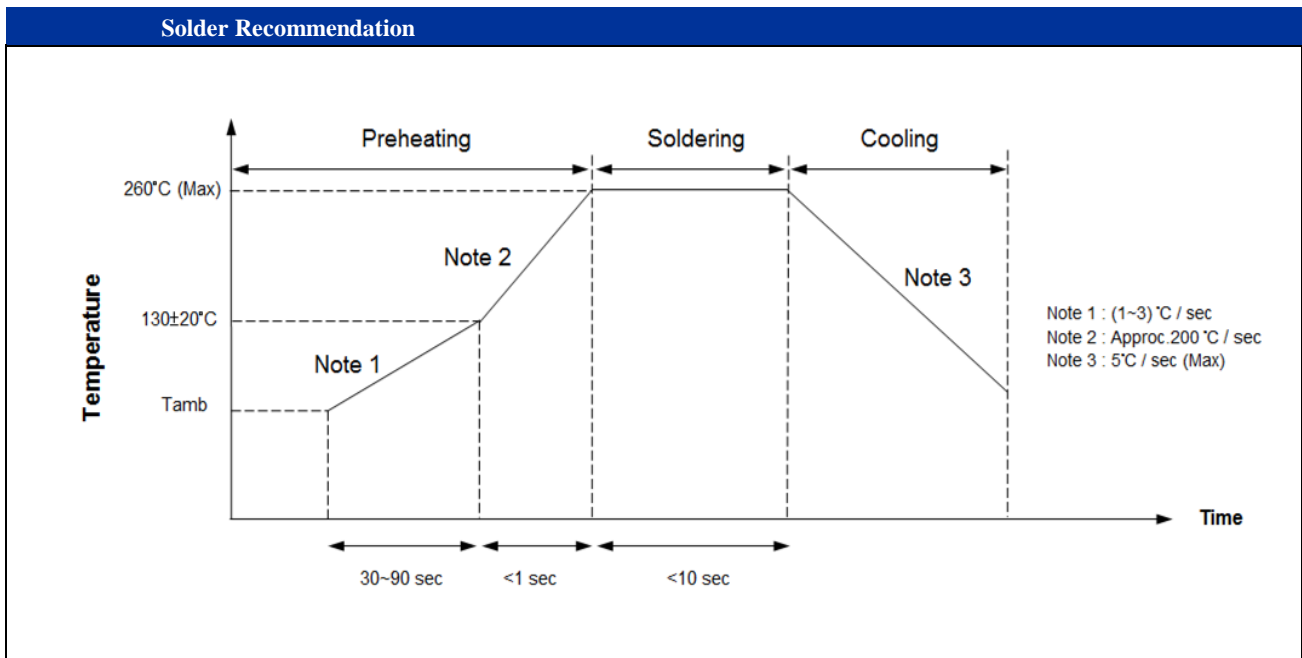

Recommendation Reworking Conditions with Soldering Iron	
Item	Conditions
Temperature of soldering Iron-tip	360°C (Max)
Soldering Time	3 sec(Max)
Distance from Varistor	2mm(Min)

RoHS Compliant Declaration

We hereby declare that the components delivered to your company are compliant with RoHS Directive 2002/95/EC

Storage Conditions of Products

- (I) Storage Conditions:
- 1.Storage Temperature: -10°C ~+40°C
 - 2.Relative Humidity: ≤ 75% RH
 - 3.Keep away from corrosive atmosphere and sunlight
 - 4.Solvent Resistance: MIL-STD-202, Method 215F
 - 5.Moisture Sensitivity: Level 1, J-STD-020

(II) Period of Storage: 1 year

Explanation of Part Numbers

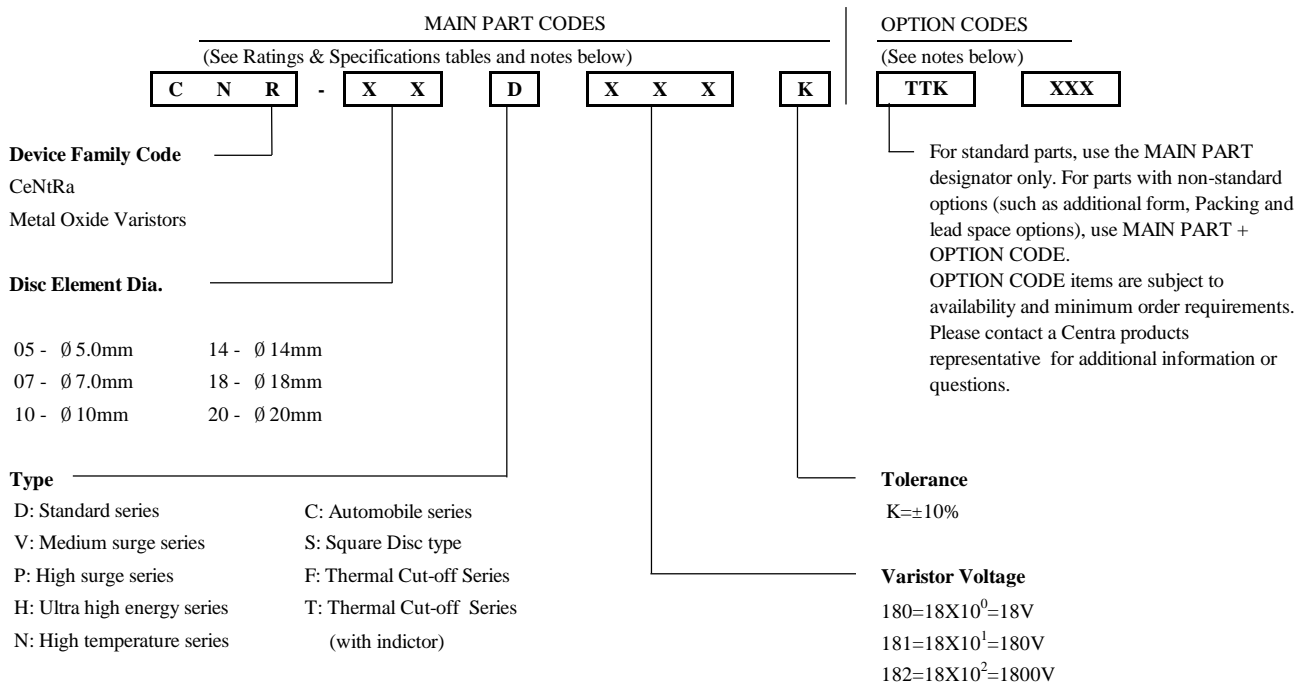

Ordering Notes:

MAIN PART CODES

Series + /Packaging/ Lead Style / Designators:

Ordering examples:

Straight Lead Bulk Pack (Standard) CNR-10D471K	Straight Lead (Short Cut) Bulk Pack CNR-10D471KTTSXXX	Straight Lead Tape & Reel Pack CNR-10D471KTRSX	Straight Lead Flat Box Pack CNR-10D471KBTSX
Outside Kink Lead Bulk Pack CNR-10D471SOK	Outside Kink Lead (Short Cut) Bulk Pack CNR-10D471KTTKXXX	Outside Kink Lead Tape & Reel Pack CNR-10D471KTRKX	Outside Kink Lead Flat Box Pack CNR-10D471KBTkX
Inside Kink Lead Bulk Pack CNR-10D471KSIK	Inside Kink Lead (Short Cut) Bulk Pack CNR-10D471KTtIXXX	Inside Kink Lead Tape & Reel Pack CNR-10D471KTRIX	Inside Kink Lead Flat Box Pack CNR-10D471KBTIX
In Line Kink Lead Bulk Pack CNR-10D471KSHK	In Line Kink Lead (Short Cut) Bulk Pack CNR-10D471KTTHXXX	In Line Kink Lead Tape & Reel Pack CNR-10D471KTRHX	In Line Kink Lead Flat Box Pack CNR-10D471KBTHX

Option Code

+ XXX

Short Cut Lead Length 10mm±1.0mm CNR-10D471KTTS10
Tape & Reel Pack Feed Hole Pitch CNR-10D471KTRSA CNR-10D471KTRSB

A: P₀ → 12.7mm±0.2mm
B: P₀ → 15.0mm±0.2mm

CeNtRa D Series varistors are shipped standard in bulk pack with straight leads or Kink lead and lead spacing outlined in the Package Dimensions section of this data sheet. Contact your CeNtRa sales representative to discuss non-standard options.