

Description

The HSM6032 is the high cell density trenched N-ch MOSFETs, which provide excellent RDSON and gate charge for most of the synchronous buck converter applications.

The HSM6032 meet the RoHS and Green Product requirement, 100% EAS guaranteed with full function reliability approved.

- Super Low Gate Charge
- 100% EAS Guaranteed
- Green Device Available
- Excellent CdV/dt effect decline
- Advanced high cell density Trench technology

Product Summary

V_{DS}	60	V
$R_{DS(ON),max}$	8.5	m Ω
I_D	13	A

SOP8 Pin Configuration

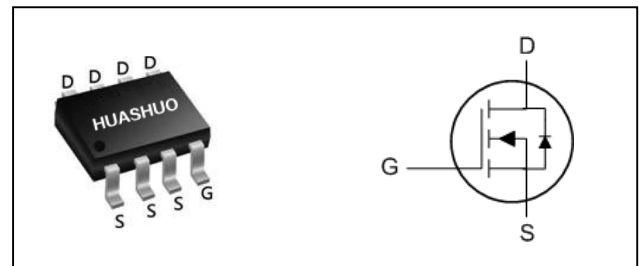

Absolute Maximum Ratings

Symbol	Parameter	Rating	Units
V_{DS}	Drain-Source Voltage	60	V
V_{GS}	Gate-Source Voltage	± 20	V
$I_D@T_A=25^\circ C$	Continuous Drain Current, $V_{GS} @ 10V^1$	13	A
$I_D@T_A=100^\circ C$	Continuous Drain Current, $V_{GS} @ 10V^1$	8	A
I_{DM}	Pulsed Drain Current ²	60	A
EAS	Single Pulse Avalanche Energy ³	80	mJ
I_{AS}	Avalanche Current	40	A
$P_D@T_A=25^\circ C$	Total Power Dissipation ⁴	2.7	W
T_{STG}	Storage Temperature Range	-55 to 150	$^\circ C$
T_J	Operating Junction Temperature Range	-55 to 150	$^\circ C$

Thermal Data

Symbol	Parameter	Typ.	Max.	Unit
$R_{\theta JA}$	Thermal Resistance Junction-ambient ¹ ($t \leq 10S$)	---	45	$^\circ C/W$
	Thermal Resistance Junction-ambient ¹ (Steady State)	---	80	$^\circ C/W$



Electrical Characteristics ($T_J=25\text{ }^\circ\text{C}$, unless otherwise noted)

Symbol	Parameter	Conditions	Min.	Typ.	Max.	Unit
BV_{DSS}	Drain-Source Breakdown Voltage	$V_{GS}=0V, I_D=250\mu A$	60	---	---	V
$R_{DS(on)}$	Static Drain-Source On-Resistance ²	$V_{GS}=10V, I_D=10A$	---	---	8.5	$m\Omega$
		$V_{GS}=4.5V, I_D=8A$	---	---	12	$m\Omega$
$V_{GS(th)}$	Gate Threshold Voltage	$V_{GS}=V_{DS}, I_D=250\mu A$	1.2	---	2.5	V
I_{DSS}	Drain-Source Leakage Current	$V_{DS}=48V, V_{GS}=0V, T_J=25^\circ C$	---	---	1	μA
		$V_{DS}=48V, V_{GS}=0V, T_J=55^\circ C$	---	---	5	
I_{GSS}	Gate-Source Leakage Current	$V_{GS}=\pm 20V, V_{DS}=0V$	---	---	± 100	nA
g_{fs}	Forward Transconductance	$V_{DS}=5V, I_D=10A$	---	50	---	S
Q_g	Total Gate Charge (10V)	$V_{DS}=48V, V_{GS}=10V, I_D=10A$	---	57	---	nC
Q_{gs}	Gate-Source Charge		---	8.7	---	
Q_{gd}	Gate-Drain Charge		---	14	---	
$T_{d(on)}$	Turn-On Delay Time	$V_{DD}=30V, V_{GS}=10V, R_G=3.3\Omega, I_D=10A$	---	16.2	---	ns
T_r	Rise Time		---	41.2	---	
$T_{d(off)}$	Turn-Off Delay Time		---	56.4	---	
T_f	Fall Time		---	16.2	---	
C_{iss}	Input Capacitance	$V_{DS}=25V, V_{GS}=0V, f=1MHz$	---	3307	---	pF
C_{oss}	Output Capacitance		---	201	---	
C_{rss}	Reverse Transfer Capacitance		---	151	---	

Diode Characteristics

Symbol	Parameter	Conditions	Min.	Typ.	Max.	Unit
I_S	Continuous Source Current ^{1,5}	$V_G=V_D=0V, \text{Force Current}$	---	---	10	A
I_{SM}	Pulsed Source Current ^{2,5}		---	---	60	A
V_{SD}	Diode Forward Voltage ²	$V_{GS}=0V, I_S=1A, T_J=25^\circ C$	---	---	1.2	V
t_{rr}	Reverse Recovery Time	$I_F=10A, dI/dt=100A/\mu s, T_J=25^\circ C$	---	24	---	nS
Q_{rr}	Reverse Recovery Charge		---	15	---	nC

Note :

- 1.The data tested by surface mounted on a 1 inch² FR-4 board with 2OZ copper.
- 2.The data tested by pulsed , pulse width $\leq 300\mu s$, duty cycle $\leq 2\%$
- 3.The EAS data shows Max. rating . The test condition is $V_{DD}=50V, V_{GS}=10V, L=0.1mH, I_{AS}=40A$
- 4.The power dissipation is limited by 150 $^\circ\text{C}$ junction temperature
- 5.The data is theoretically the same as I_D and I_{DM} , in real applications , should be limited by total power dissipation.



Typical Characteristics

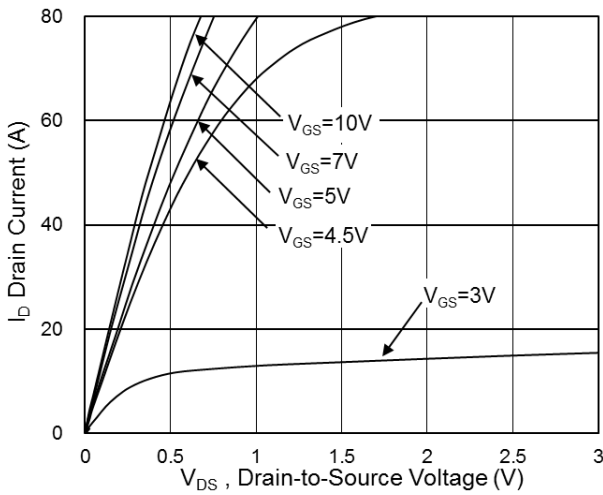

Fig.1 Typical Output Characteristics

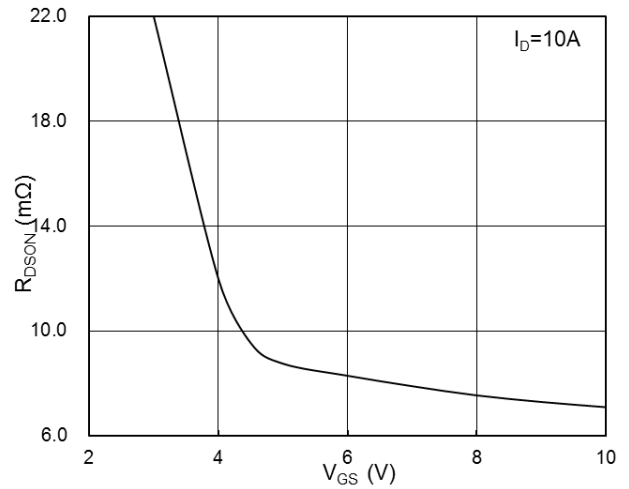

Fig.2 On-Resistance v.s Gate-Source Voltage

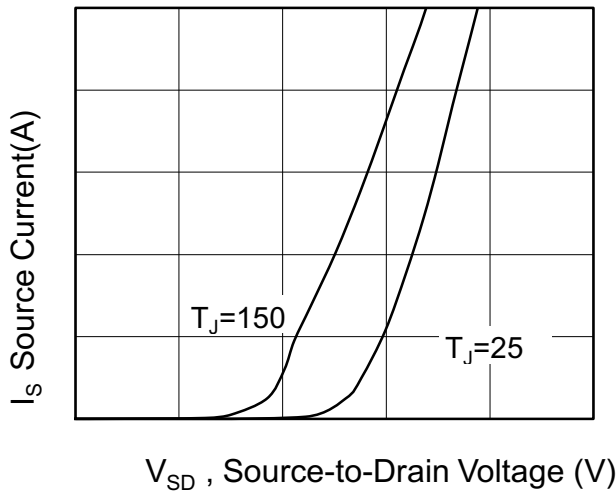

Fig.3 Forward Characteristics of Reverse

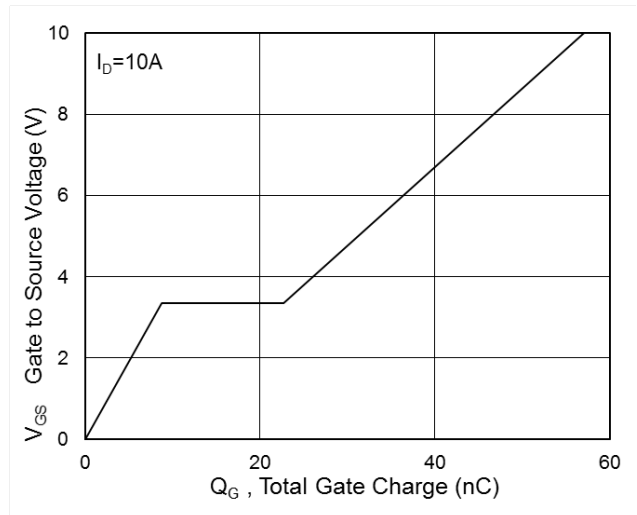

Fig.4 Gate-Charge Characteristics

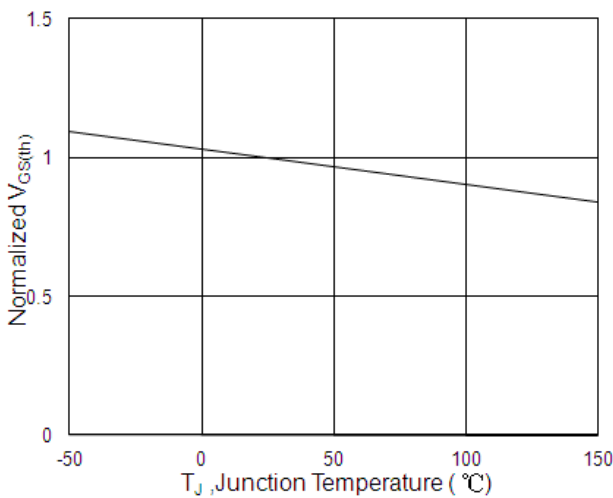

Fig.5 Normalized $V_{GS(th)}$ vs. T_J

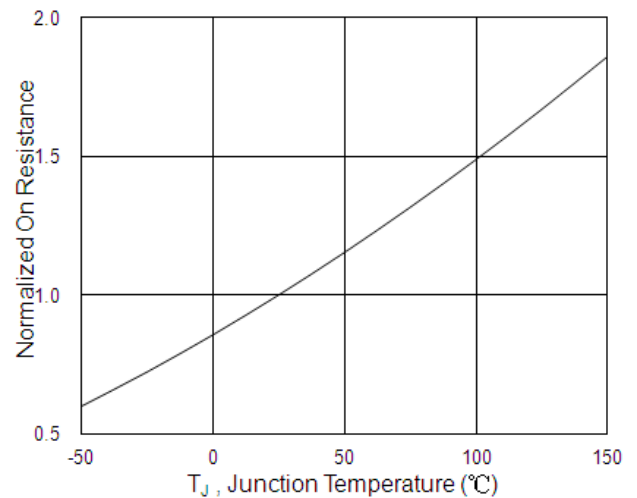

Fig.6 Normalized $R_{DS(on)}$ vs. T_J

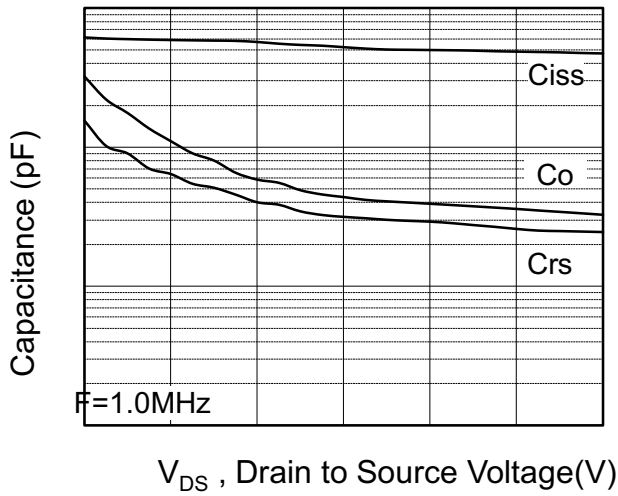

Fig.7 Capacitance

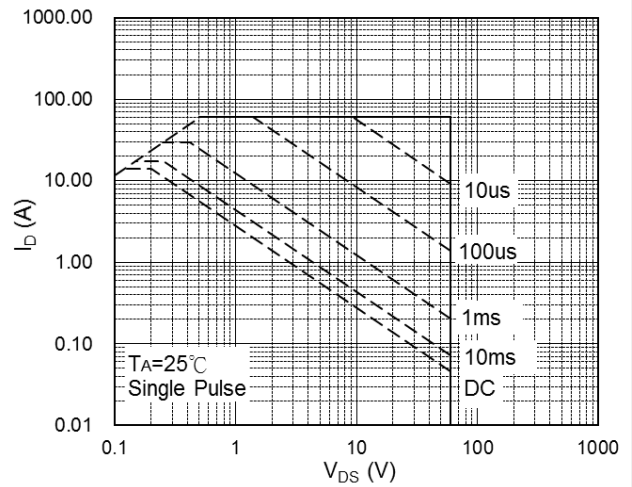

Fig.8 Safe Operating Area

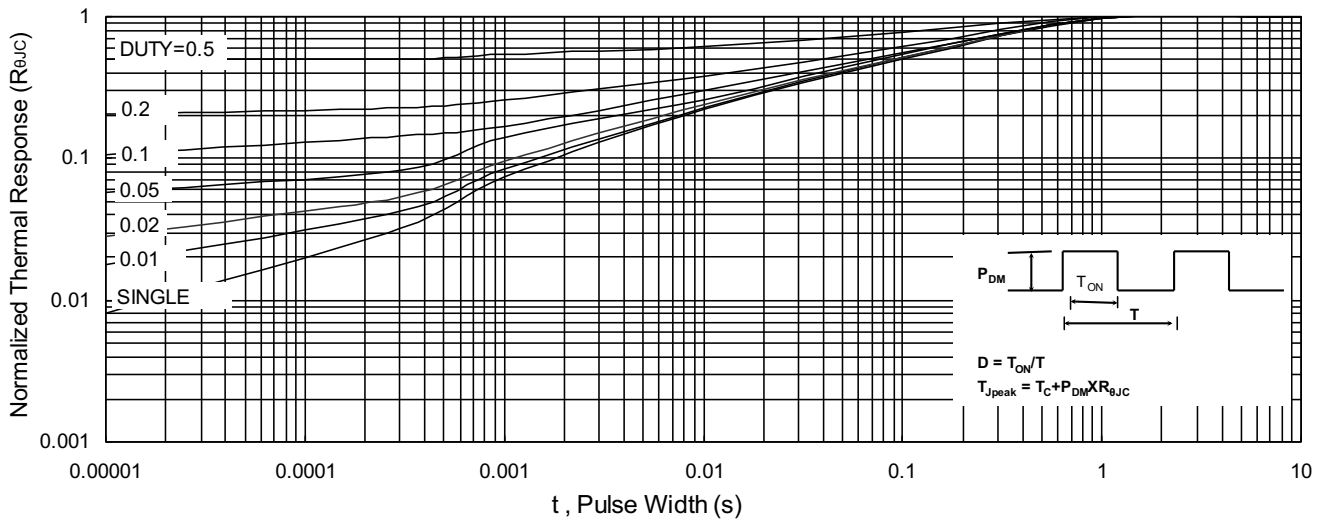

Fig.9 Normalized Maximum Transient Thermal Impedance

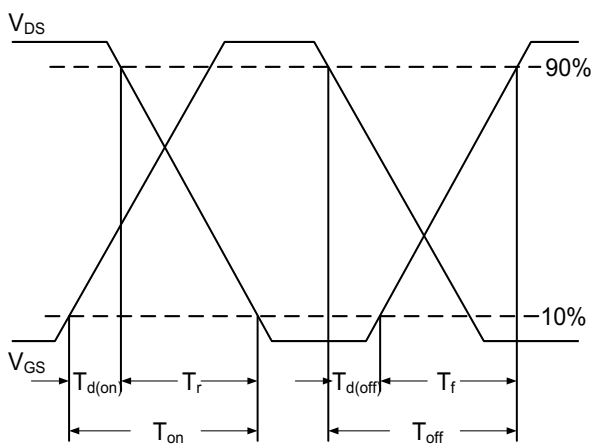

Fig.10 Switching Time Waveform

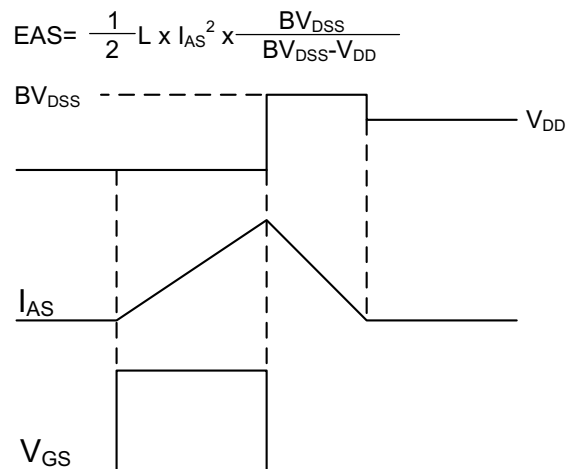

Fig.11 Unclamped Inductive Switching