

UTC358

LINEAR INTEGRATED CIRCUIT

DUAL OPERATIONAL AMPLIFIERS

DESCRIPTION

The UTC358 consists of dual independent, high gain internally frequency compensated operational amplifiers which were designed specifically to operate from a single power supply over a wide voltage range.

Operation from split power supplies is also possible so long as the difference between the two supplies is 3 volts to 32 volts.

Application areas include transducer amplifier, DC gain blocks and all the conventional OP amp circuits which now can be easily implemented in single power supply system.

FEATURES

- *Internally frequency compensated for unity gain
- *Large DC voltage gain :100dB
- *Wide operating supply range($V_{CC}=3V\sim 32V$)
- *Input common-mode voltage includes ground
- *Large output voltage swing:From 0V to $V_{CC}-1.5V$
- *Power drain suitable for battery operation

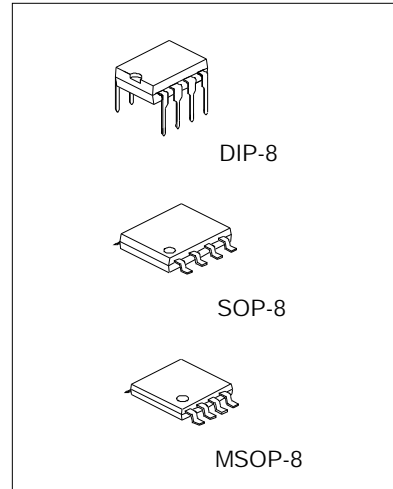

ORDERING INFORMATION

Device	Package
UTC358D	DIP-8-300-2.54
UTC358	SOP-8-225-1.27
UTC358N	MSOP-8-170-0.65

BLOCK DIAGRAM

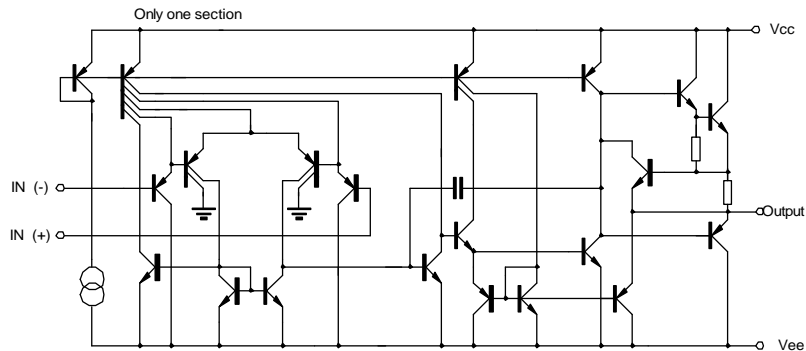

ABSOLUTE MAXIMUM RATINGS(Ta=25°C)

Characteristic	Symbol	Value	Unit
Supply Voltage	Vcc	±18	V
Differential input voltage	V _{I(DIFF)}	32	V
Input Voltage	V _I	-0.3~32V	V
Power Dissipation	Pd	570	mW
Operating Temperature	Topr	0 to +70	°C
Storage Temperature	Tstg	-65 to 150	°C

ELECTRICAL CHARACTERISTICS(Ta=25°C)

(Vcc=5.0V, All voltage referenced to GND unless otherwise specified)

Characteristic	Symbol	Test Condition	Min	Typ.	Max	Unit
Input offset voltage	V _{IO}	V _{CM} =0 to Vcc-1.5 Vo(p)=1.4V, Rs=0		2.9	7.0	mV
Input offset current	I _{IO}			5.0	50	nA
Input Bias current	I _b			45	250	nA
Input Common-mode voltage range	V _{I(R)}	Vcc=30V	0	Vcc-1.5		V
Supply Current	I _{CC}	RL=∞, Vcc=30V		0.8	2.0	mA
		Vcc=5V		0.5	1.2	mA
Large signal Voltage Gain	G _v	Vcc=15V, RL>2kΩ Vo(p)=1V to 11V	25	100		V/mV
Output voltage Swing	V(OH) V(OL)	Vcc=30V, RL=2kΩ	26			V
		Vcc=30V, RL=10kΩ	27	28		V
		Vcc=5, RL>10kΩ		5	20	mV
Common-mode rejection Ratio	CMRR		65	75		dB
Power supply rejection Ratio	PSRR		65	100		dB
Chanel Separation	CS	f=1kHz to 20kHz		5	20	mV
Short circuit to GND	I _{sc}			40	60	mA
Output current	I _{source} I _{sink}	V _{I(+)} =1V, V _{I(-)} =0 Vcc=15V, Vo(p)=2V	20	40		mA
		V _{I(+)} =0V, V _{I(-)} =1V Vcc=15V, Vo(p)=2V	10	13		mA
		V _{I(+)} =1V, V _{I(-)} =0 Vcc=15V, Vo(p)=200V	12	45		μA
Differential input voltage	V _{I(diff)}				Vcc	V

PIN CONFIGURATION

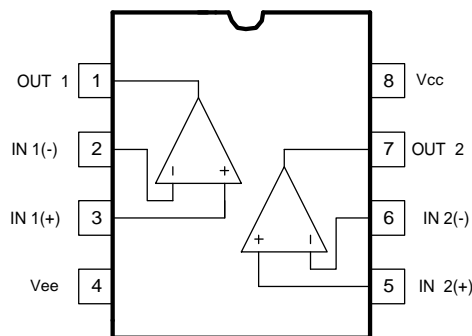

Any Class-1 or Class-2 Ozone depleting substances are not used in this component or its manufacturing. (As per defined under section 611 of the clean air act)

TYPICAL CHARACTERISTICS PERFORMANCE

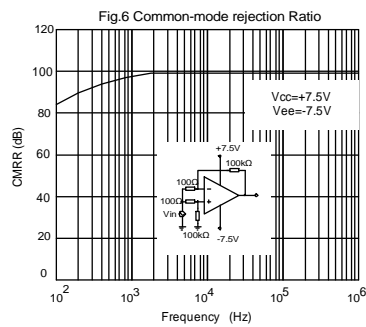
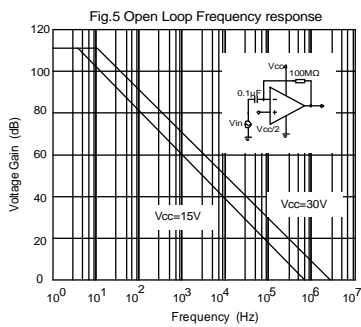
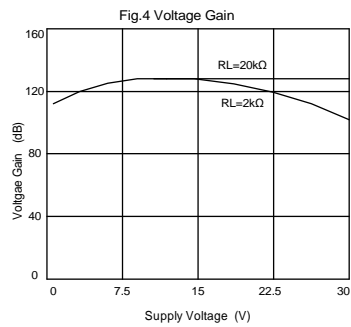
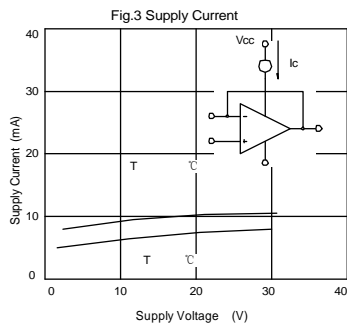
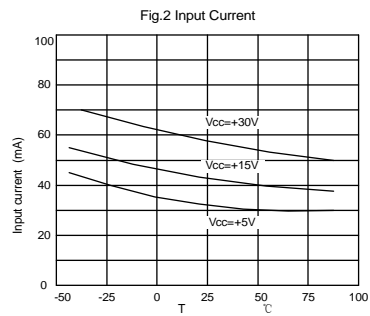
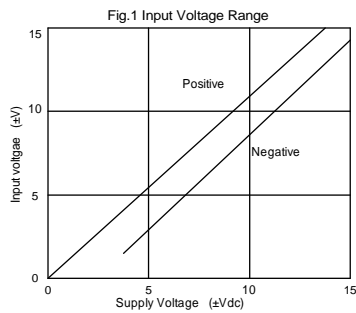

Fig.7

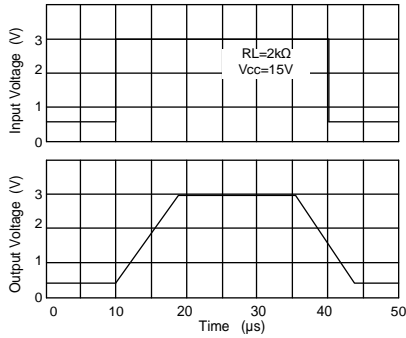

Fig.8 voltage Follower pulse response (small signal)

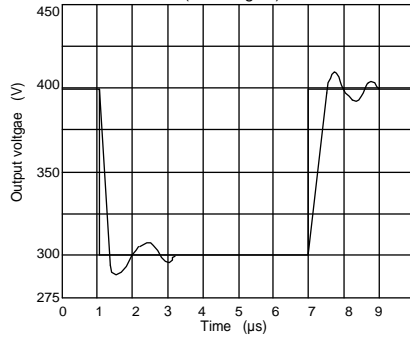

Fig.9 Large signal Frequency Response

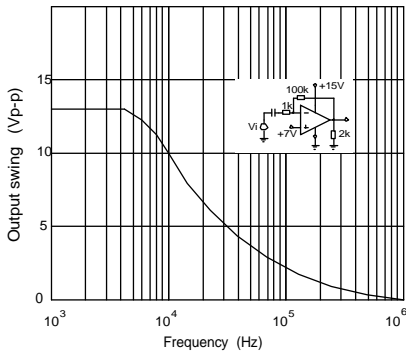

Fig.10 Output Characteristics current sourcing

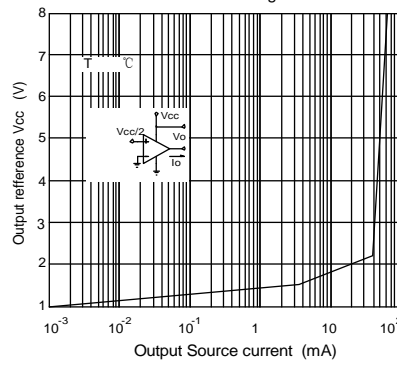

Fig.11 Output Characteristics Current sinking

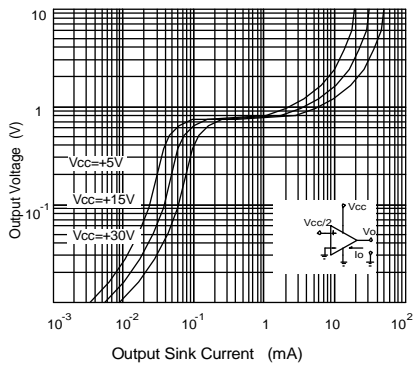
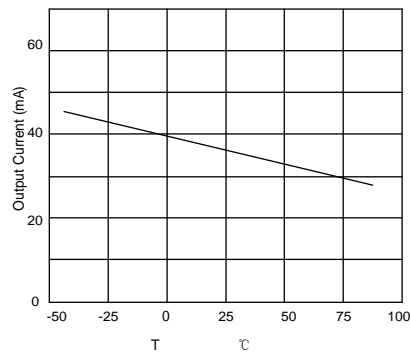

Fig.12 Current Limiting



UTC358

LINEAR INTEGRATED CIRCUIT

PACKAGE OUTLINE

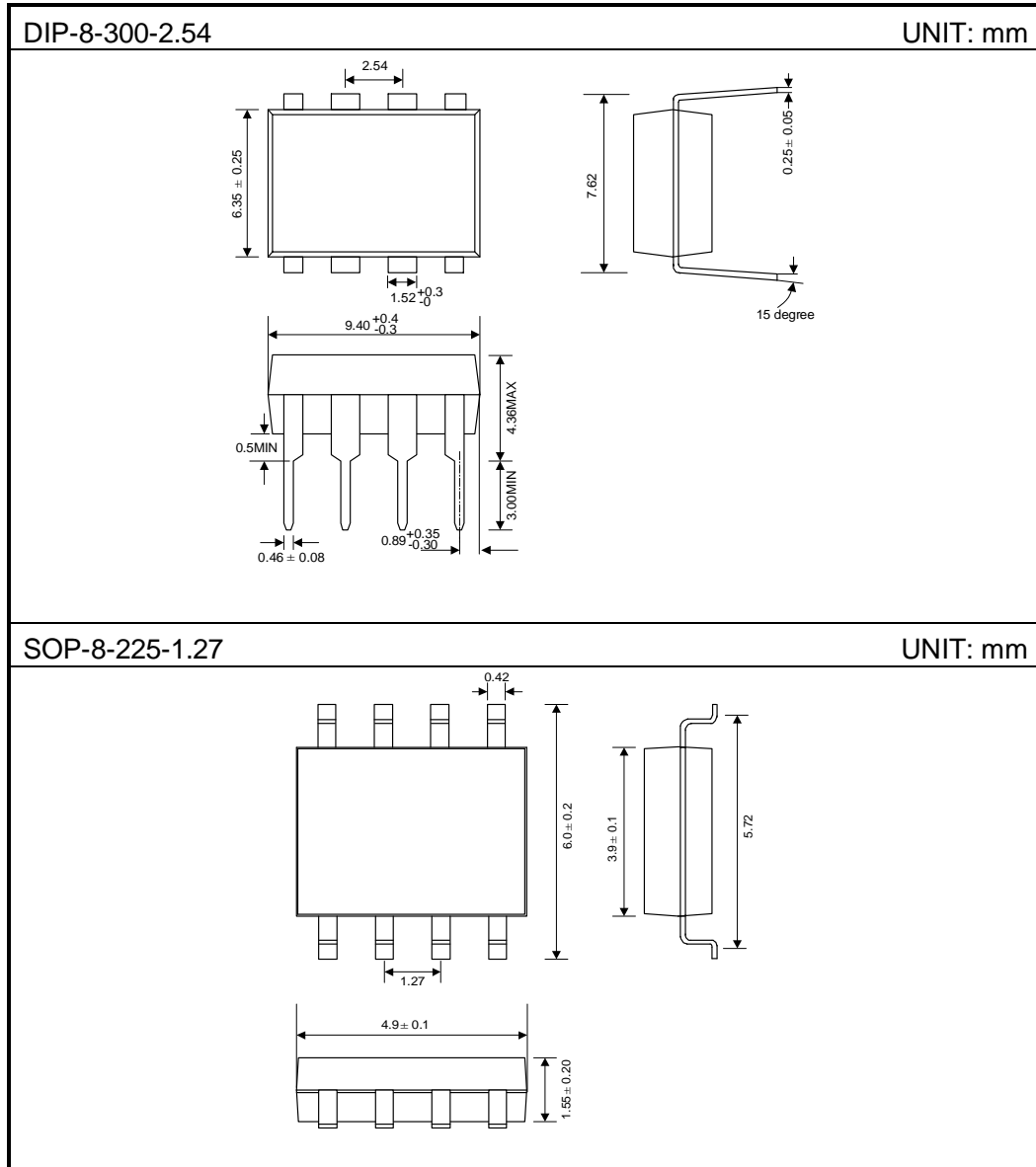

PACKAGE OUTLINE

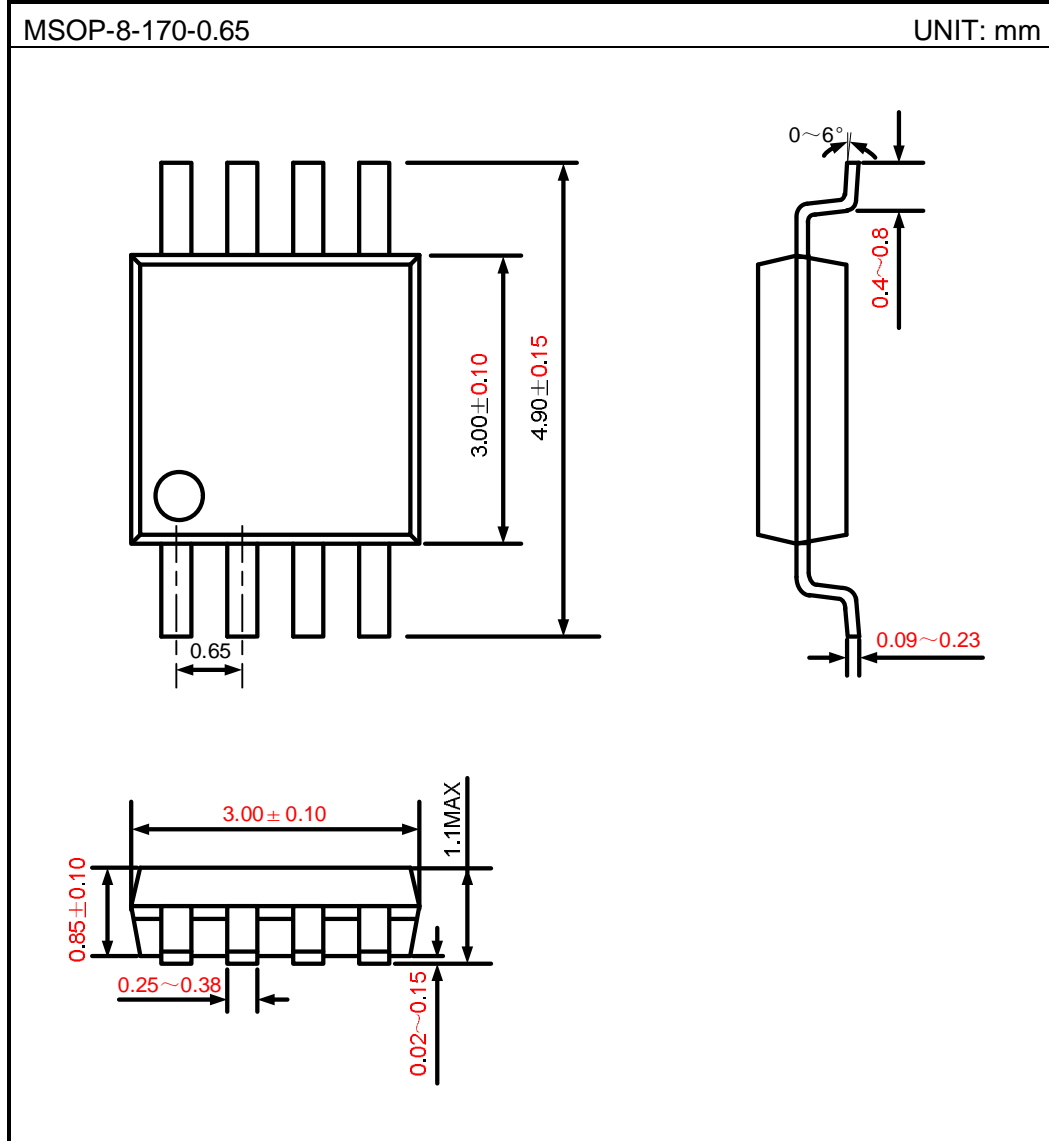

Attach

Revision History

Data	REV	Description	Page
	1.0	Original	
2006.03.27	1.1	Add" Ordering Information"	1
2007.02.27	1.2	Add Package Outline "MSOP-8-0.65"	5