

ELECTRONICS



# Positive Thermal Coefficient

SMD1210 Series

# Positive Thermal Coefficient - SMD1210 Series

## Features

1. I(hold): 0.05~2A
2. RoHS compliant, lead-free and halogen-free
3. Fast response to fault currents
4. Compact design saves board space
5. Low resistance
6. Low-profile
7. Compatible with high temperature solders



## Applications

1. USB peripherals
2. Disk drives
3. CD-ROMs
4. Plug and play protection for motherboards and peripherals
5. Mobile phones - battery and port protection
6. Disk drives
7. PDAs / digital cameras
8. Game console port protecti

## Product Name

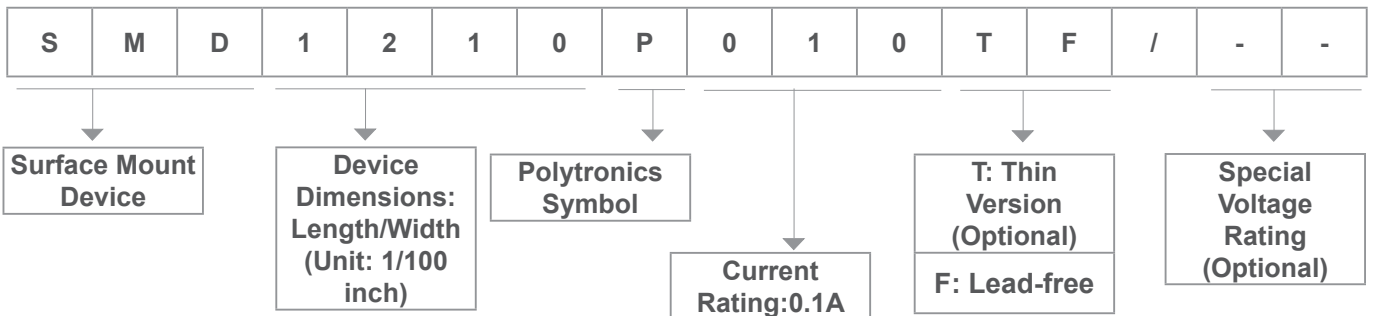

# Positive Thermal Coefficient - SMD1210 Series

## Dimension

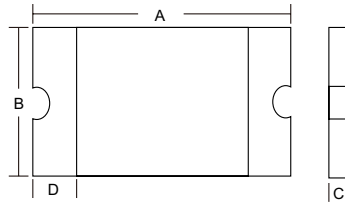

Type Number	Marking	I <sub>hold</sub>	I <sub>trip</sub>	Maximum Time To Trip		V <sub>max</sub>	I <sub>max</sub>	P <sub>dmax</sub>	R <sub>min</sub>	R <sub>1max</sub>	Package	Package Dimensions (mm)						
				Current A	Time s							A		B		C		D
												min	max	min	max	min	max	
SMD1210P005TF	A	0.05	0.15	0.25	1.5	30	100	0.6	2.8	50	1210	3	3.43	2.35	2.8	0.3	0.8	0.3
SMD1210P010TF	1	0.1	0.3	0.5	0.6	30	100	0.6	0.8	15	1210	3	3.43	2.35	2.8	0.3	0.8	0.3
SMD1210P020TF	2	0.2	0.4	8	0.02	30	100	0.6	0.4	5	1210	3	3.43	2.35	2.8	0.3	0.8	0.3
SMD1210P035TF	3	0.35	0.75	8	0.2	6	100	0.6	0.2	1.3	1210	3	3.43	2.35	2.8	0.3	0.8	0.3
SMD1210P050TF	5	0.5	1	8	0.1	13.2	100	0.6	0.18	0.9	1210	3	3.43	2.35	2.8	0.3	0.8	0.3
SMD1210P075TF	7	0.75	1.5	8	0.1	6	100	0.6	0.07	0.4	1210	3	3.43	2.35	2.8	0.3	0.8	0.3
SMD1210P110TF	0	1.1	2.2	8	0.3	6	100	0.6	0.05	0.21	1210	3	3.43	2.35	2.8	0.3	0.8	0.3
SMD1210P150TF	X	1.5	3	8	0.5	6	100	0.8	0.03	0.11	1210	3	3.43	2.35	2.8	0.4	0.8	0.3
SMD1210P175TF	Y	1.75	3.6	8	0.6	6	100	0.8	0.02	0.08	1210	3	3.43	2.35	2.8	0.4	0.8	0.3
SMD1210P200TF	Z	2	4	8	1	6	100	0.8	0.015	0.07	1210	3	3.43	2.35	2.8	0.4	1.2	0.3

### Vocabulary

I<sub>hold</sub> = Hold current: maximum current device will pass without tripping in 23°C still air.

I<sub>trip</sub> = Trip current: minimum current at which the device will trip in 23 °C still air.

V<sub>max</sub> = Maximum voltage device can withstand without damage at rated current (I<sub>max</sub>)

I<sub>max</sub> = Maximum fault current device can withstand without damage at rated voltage (V<sub>max</sub>)

P<sub>d typ</sub> = Typical power dissipated from device when in the tripped state at 23 °C still air.

R<sub>min</sub> = Minimum resistance of device in initial (un-soldered) state.

R<sub>1max</sub> = Maximum resistance of device at 23 °C measured one hour after tripping or reflow soldering of 260 °C for 20 sec.

# Positive Thermal Coefficient - SMD1210 Series

## Thermal Derating Curve

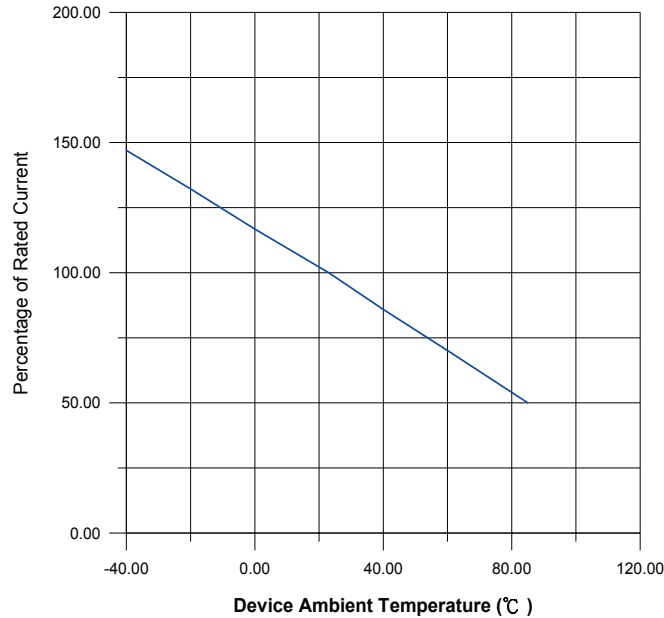

## Thermal Derating Chart

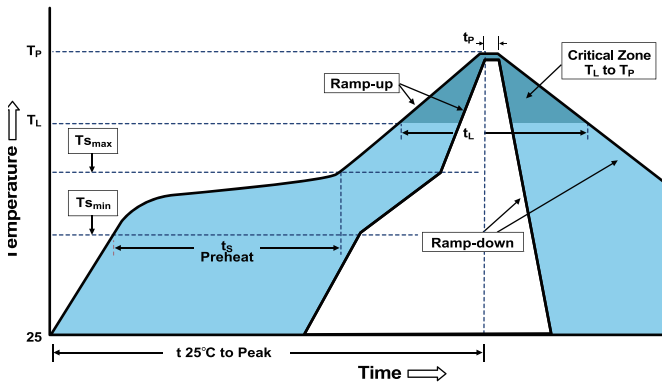

Profile Feature	Pb-Free Assembly
Average Ramp-Up Rate( $T_s$ max to $T_p$ )	3°C/second max.
Preheat	
-Temperature Min( $T_s$ min)	150°C
-Temperature Max( $T_s$ max)	200°C
-Time( $T_s$ min to $T_s$ max)	60~180 seconds
Time maintained above:	
-Temperature( $T_L$ )	+217°C
-Time( $t_L$ )	60~150 seconds
Peak Temperature( $T_p$ )	260°C
Ramp-Down Rate	6°C/second max.
Time 25°C to Peak Temperature	8 minutes max
Storage Condition	0°C~35°C, 70%RH

- Recommended reflow methods: IR, vapor phase oven, hot air oven, N2 environment for lead-free
- Recommended maximum paste thickness is 0.25mm (0.010 inch)
- Devices can be cleaned using standard industry methods and solvents.

Note 1: All temperature refer to topside of the package, measured on the package body surface.

Note 2: If reflow temperatures exceed the recommended profile, devices may not meet the performance requirements.

# Positive Thermal Coefficient - SMD1210 Series

## Average Time-Current Curve

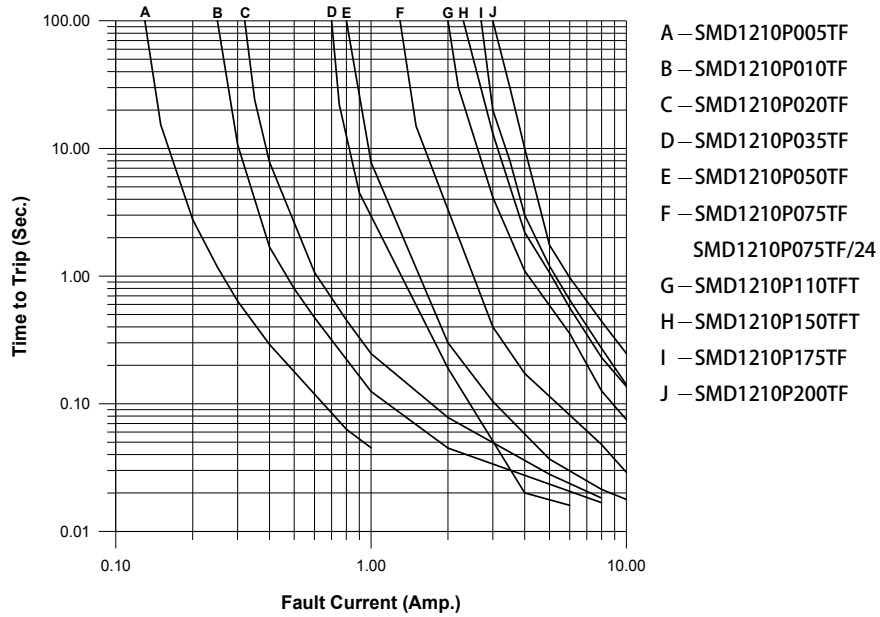

## Average Time-Current Curve

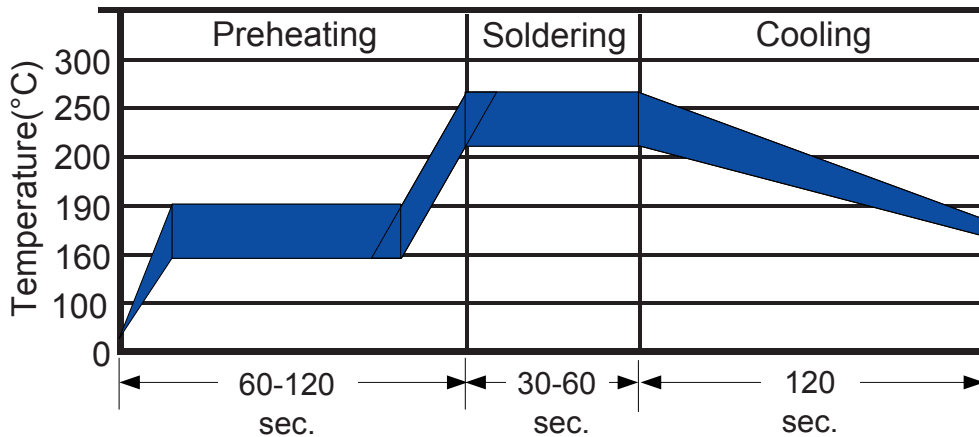

·Recommended reflow methods: IR, vapor phase oven, hot air oven, N2 environment for lead-free

·Recommended maximum paste thickness is 0.25mm (0.010 inch)

·Devices can be cleaned using standard industry methods and solvents.

Note 1: All temperature refer to topside of the package, measured on the package body surface.

Note 2: If reflow temperatures exceed the recommended profile, devices may not meet the performance requirements.

# Positive Thermal Coefficient - SMD1210 Series

## Tape And Reel Specifications (mm) EIA Tape Component Dimention

Governing Specifications	EIA 481-2
W	12 ± 0.20
P <sub>0</sub>	4.0 ± 0.10
P <sub>1</sub>	8.0 ± 0.10
P <sub>2</sub>	2.0 ± 0.05
A <sub>0</sub>	3.5 ± 0.23
B <sub>0</sub>	5.1 ± 0.15
B <sub>1max</sub>	5.9
D <sub>0</sub>	1.5+0.1,-0
F	5.5 ± 0.05
E <sub>1</sub>	1.75 ± 0.10
E <sub>2min</sub>	10.25
T <sub>max</sub>	0.6
T <sub>1max</sub>	0.1
K <sub>0</sub>	0.9 ± 0.15
Leader min.	390
Trailer min.	160
Reel Dimensions	
A max	178
N min.	60
W <sub>1</sub>	12.4+20,-0.0
W <sub>2max</sub> .	18.4

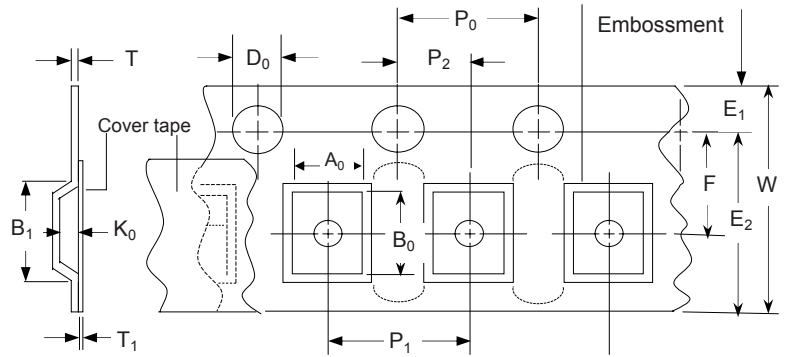

## EIA Reel Dimentions

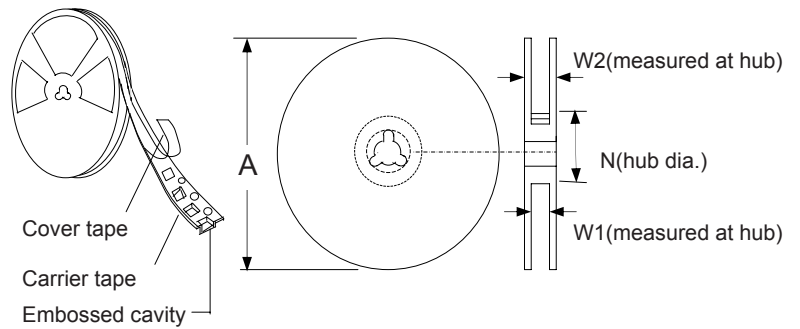

### Storage And Handling

- Storage conditions : 40°C max, 70% R.H.
- Devices may not meet specified performance if storage conditions are exceeded.

## Positive Thermal Coefficient - SMD1210 Series

### Thermal Derating Chart

Part Number	-40°C	-20°C	0°C	23°C	40°C	50 °C	60°C	70°C	85°C
SMD1210P005TF	0.08	0.07	0.06	0.05	0.04	0.04	0.03	0.03	0.02
SMD1210P010TF	0.16	0.14	0.12	0.10	0.08	0.07	0.06	0.05	0.05
SMD1210P020TF	0.29	0.26	0.22	0.20	0.16	0.14	0.13	0.11	0.08
SMD1210P035TF	0.47	0.45	0.40	0.35	0.33	0.28	0.24	0.21	0.18
SMD1210P050TF	0.76	0.67	0.58	0.50	0.43	0.40	0.36	0.32	0.28
SMD1210P075TF	1.00	0.97	0.86	0.75	0.64	0.59	0.54	0.48	0.40
SMD1210P075TF/24	1.00	0.97	0.86	0.75	0.64	0.59	0.54	0.48	0.40
SMD1210P110TFT	1.60	1.42	1.26	1.10	0.94	0.86	0.80	0.70	0.58
SMD1210P150TFT	2.30	2.02	1.76	1.50	1.24	1.11	1.00	0.85	0.65
SMD1210P175TF	2.45	2.22	2.01	1.75	1.45	1.26	1.10	0.98	0.80
SMD1210P200TF	2.60	2.44	2.35	2.00	1.78	1.67	1.50	1.45	1.10

### Warehouse Storage Conditions of Products

- Storage Conditions:
  1. Storage Temperature: -10°C~+40°C
  2. Relative Humidity: ≤75%RH
  3. Keep away from corrosive atmosphere and sunlight.
- Period of Storage: 1 year