



## 1.5A, up to 28V Output 1.2MHz Step-Up Converter

### FEATURES

- Integrated 0.5Ω Power MOSFET
- 40μA Quiescent Current
- 2.5V to 5.5V Input Voltage
- 1.2MHz Fixed Switching Frequency
- Internal 1.5A Switch Current Limit
- Adjustable Output Voltage
- Internal Compensation
- Up to 28V Output Voltage
- Automatic Pulse Frequency Modulation Mode at Light Loads
- Over 85% Efficiency
- Available in a 5-Pin SOT23-5 Package

### APPLICATIONS

- OLED Biasing
- LCD Bias Supply
- White LED Driver
- PDAs
- Digital Still Cameras

### GENERAL DESCRIPTION

The SDB2F5 is a constant frequency, 5-pin SOT23 current mode step-up converter intended for small, low power applications. The SDB2F5 switches at 1.2MHz and allows the use of tiny, low cost capacitors and inductors 2mm or less in height. Internal soft-start results in small inrush current and extends battery life. The SDB2F5 operates from an input voltage as low as 2.5V and can generate 28V at up to 100mA from a 5V supply. The SDB2F5 features automatic shifting to pulse frequency modulation mode at light loads. The SDB2F5 includes under-voltage lockout, current limiting, and thermal overload protection to prevent damage in the event of an output overload. The SDB2F5 is available in a small 5-pin SOT-23 package.

### TYPICAL APPLICATION

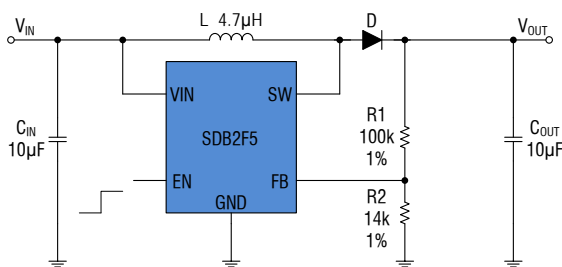
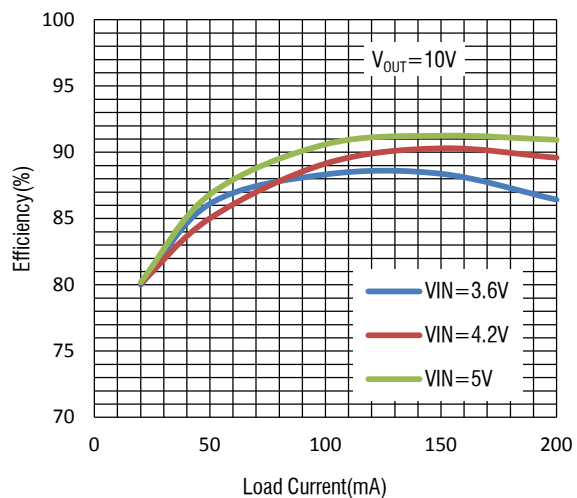

Figure 1. Basic Application Circuit



## ABSOLUTE MAXIMUM RATINGS (Note 1)

Input Supply Voltage.....	-0.3V to 6V	Junction Temperature(Note2).....	160°C
EN,FB Voltages.....	-0.3V to 6V	Operating Temperature Range.....	-40°C to 85°C
SW Voltage.....	-0.3V to 30V	Lead Temperature(Soldering,10s).....	300°C
Power Dissipation.....	0.6W	Storage Temperature Range.....	-65°C to 150°C
Thermal Resistance $\theta_{JC}$ .....	130°C/W	ESD HBM(Human Body Mode).....	2kV
Thermal Resistance $\theta_{JA}$ .....	250°C/W	ESD MM(Machine Mode).....	200V

## PACKAGE

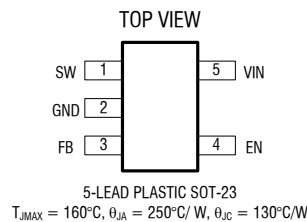

## PIN DESCRIPTION

Pin Name	Pin Number	Description
SW	1	Power Switch Output. SW is the drain of the internal MOSFET switch. Connect the power inductor and output rectifier to SW. SW can swing between GND and 28V.
GND	2	Ground Pin
FB	3	Feedback Input. The FB voltage is 1.25V. Connect a resistor divider to FB.
EN	4	Regulator On/Off Control Input. A high input at EN turns on the converter, and a low input turns it off. When not used, connect EN to the input supply for automatic startup.
VIN	5	Input Supply Pin. Must be locally bypassed.



## ELECTRICAL CHARACTERISTICS (Note 3)

(V<sub>IN</sub>=V<sub>EN</sub>=3.7V, T<sub>A</sub> = 25°C, unless otherwise noted.)

PARAMETER	CONDITIONS	MIN	TYP	MAX	UNIT
Operating Input Voltage		2.5		5.5	V
Under Voltage Lockout			2.2	2.45	V
Under Voltage Lockout Hysteresis			100		mV
Current (Shutdown)	V <sub>EN</sub> = 0V		0.1	1	μA
Quiescent Current (PFM)	V <sub>FB</sub> = 1.4V, No switch		40	60	μA
Quiescent Current (PWM)	V <sub>FB</sub> = 1V, switch		0.6	1	mA
Switching Frequency			1.2		MHz
Maximum Duty Cycle	V <sub>FB</sub> = 0V	90			%
EN Input High Voltage		1.5			V
EN Input Low Voltage				0.4	V
FB Voltage		1.225	1.25	1.275	V
FB Input Bias Current	V <sub>FB</sub> = 1.2V	-50	-10		nA
SW On Resistance			0.5		Ω
SW Current Limit	V <sub>IN</sub> = 4.2V, Duty cycle=50%		1.5		A
SW Leakage	V <sub>SW</sub> = 20V			1	μA
Thermal Shutdown			155		°C
Operating Input Voltage		2.5		5.5	V
Under Voltage Lockout			2.2	2.45	V

**Note 1:** Absolute Maximum Ratings are those values beyond which the life of a device may be impaired.

**Note 2:** T<sub>J</sub> is calculated from the ambient temperature T<sub>A</sub> and power dissipation P<sub>D</sub> according to the following formula: T<sub>J</sub> = T<sub>A</sub> + (P<sub>D</sub>) x (250°C/W).

**Note 3:** 100% production test at 25°C. Specifications over the temperature range are guaranteed by design and characterization.

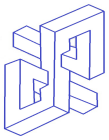

TYPICAL PERFORMANCE CHARACTERISTICS

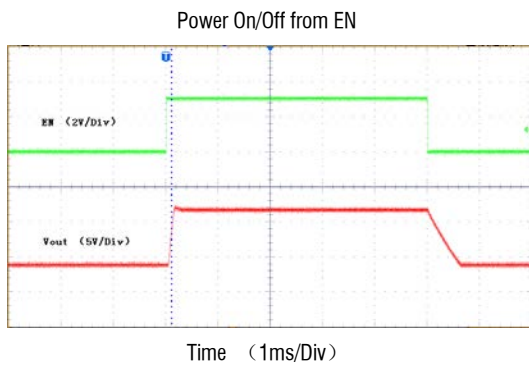
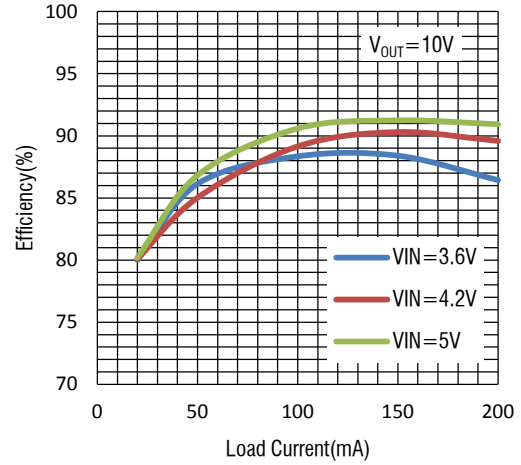
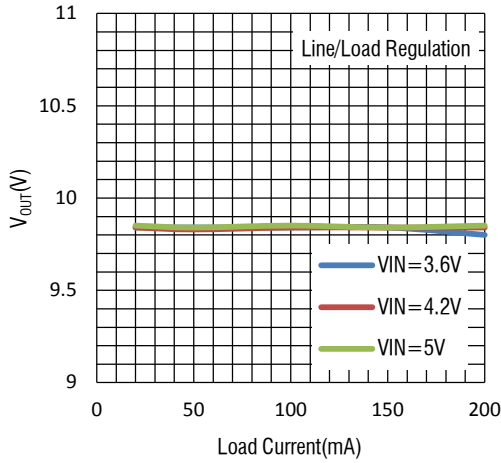

V<sub>IN</sub>=5V, V<sub>OUT</sub>=10V, I<sub>OUT</sub>=50mA  
 (CH1:V<sub>OUT</sub>(ripple) CH2:V<sub>SW</sub>)

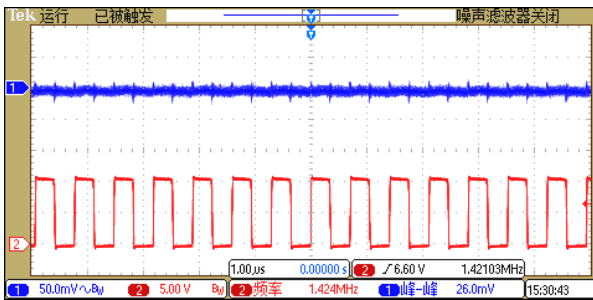

V<sub>IN</sub>=5V, V<sub>OUT</sub>=10V, I<sub>OUT</sub>=200mA  
 (CH1:V<sub>OUT</sub>(ripple) CH2:V<sub>SW</sub>)

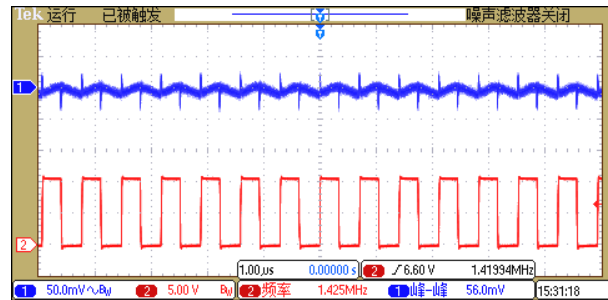



## FUNCTIONAL BLOCK DIAGRAM

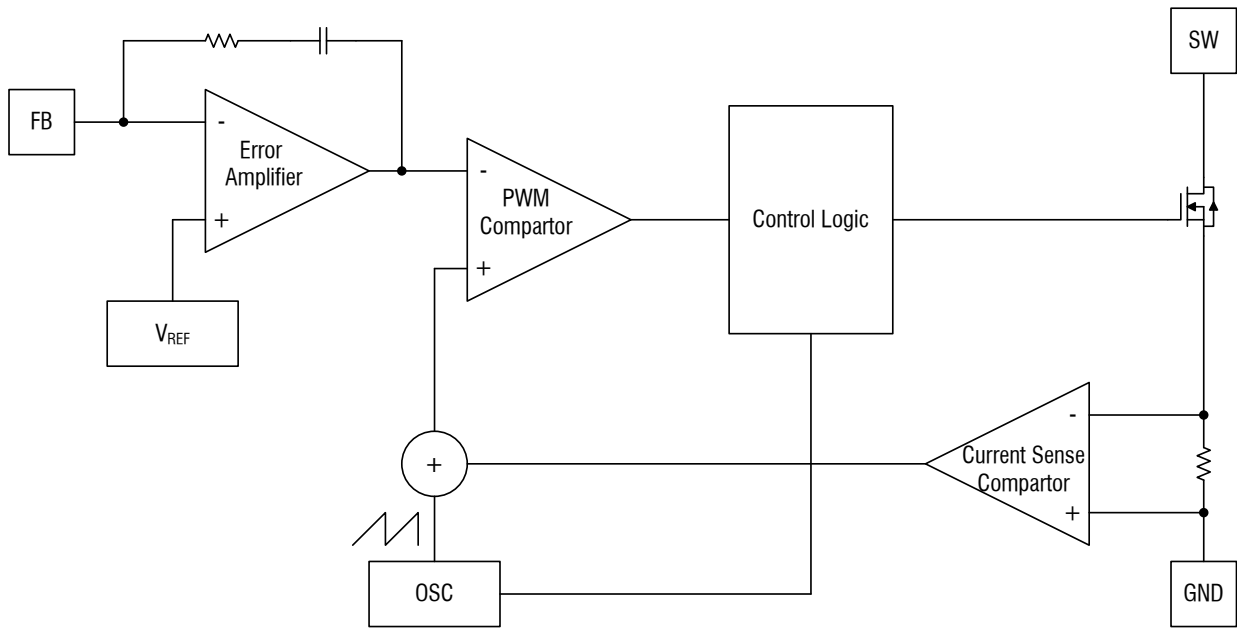

Figure 2. SDB2F5 Block Diagram

## FUNCTIONAL DESCRIPTION

The SDB2F5 uses a fixed frequency, peak current mode boost regulator architecture to regulate voltage at the feedback pin. The operation of the SDB2F5 can be understood by referring to the block diagram of Figure 2. At the start of each oscillator cycle the MOSFET is turned on through the control circuitry. To prevent sub-harmonic oscillations at duty cycles greater than 50 percent, a stabilizing ramp is added to the output of the current sense amplifier and the result is fed into the negative input of the PWM comparator. When this voltage equals the output voltage of the error amplifier the power

MOSFET is turned off. The voltage at the output of the error amplifier is an amplified version of the difference between the bandgap reference voltage and the feedback voltage. In this way the peak current level keeps the output in regulation. If the feedback voltage starts to drop, the output of the error amplifier increases. This results in more current to flow through the power MOSFET, thus increasing the power delivered to the output. The SDB2F5 has internal soft start to limit the amount of input current at startup and to also limit the amount of overshoot on the output.

## APPLICATIONS INFORMATION

### Setting the Output Voltage

The internal reference  $V_{REF}$  is 1.25V.

The output voltage is divided by a resistor divider, R1 and R2 to the FB pin. The output voltage is given by

$$V_{OUT} = V_{REF} \times \left( 1 + \frac{R_1}{R_2} \right)$$

### Inductor Selection

The recommended value of inductor are 4.7 to 22 $\mu$ H. Small size and better efficiency are the major concerns for portable device, such as SDB2F5 used for mobile phone. The inductor should have low core loss at 1.2MHz and low DCR for better efficiency. To avoid inductor saturation current rating should be considered.

### Capacitor Selection

Input and output ceramic capacitors of 1 $\mu$ F are recommended for SDB2F5 applications. For better voltage filtering, ceramic capacitors with low ESR are recommended. X5R and X7R types are suitable because of their wider voltage and temperature ranges.

### Diode Selection

Schottky diode is a good choice for SDB2F5 because of its low forward voltage drop and fast reverse recovery. Using Schottky diode can get better efficiency. The highspeed rectification is also a good characteristic of Schottky diode for high switching frequency. Current rating of the diode must meet the root mean square of the peak current and output average current multiplication as following :

$$I_D(\text{RMS}) \approx \sqrt{I_{OUT} \times I_{PEAK}}$$

The diode's reverse breakdown voltage should be larger than the output voltage.

### Layout Consideration

For best performance of the SDB2F5, the following guidelines must be strictly followed.

- Input and Output capacitors should be placed close to the IC and connected to ground plane to reduce noise coupling.
- The GND should be connected to a strong ground plane for heat sinking and noise protection.
- Keep the main current traces as possible as short and wide.
- SW node of DC-DC converter is with high frequency voltage swing. It should be kept at a small area.
- Place the feedback components as close as possible to the IC and keep away from the noisy devices.

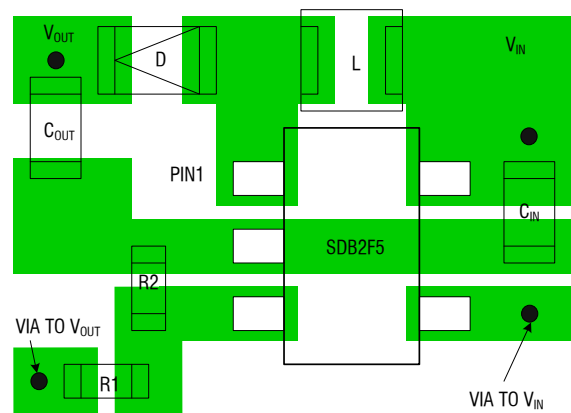
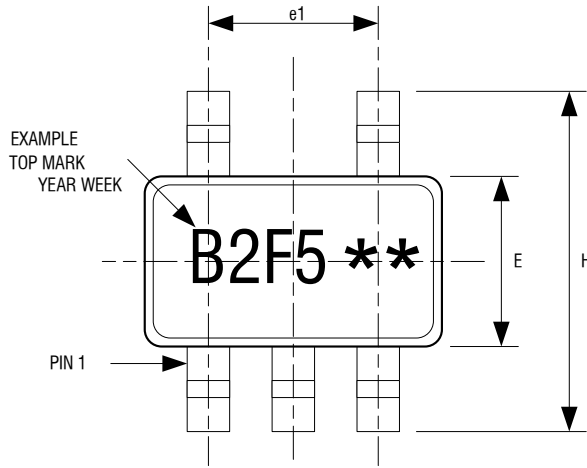

Figure 3. SDB2F5 Suggested Layout



## PACKAGE DESCRIPTION

SOT23-5



TOP VIEW

5LD SOT-23 PACKAGE OUTLINE DIMENSIONS

Dimension	Min.	Max.
A	1.05	1.35
A1	0.04	0.15
B	0.3	0.5
C	0.09	0.2
D	2.8	3.0
H	2.5	3.1
E	1.5	1.7
e	0.95 REF.	
e1	1.90 REF.	
L1	0.2	0.55
L	0.35	0.8
Q	0°	10°

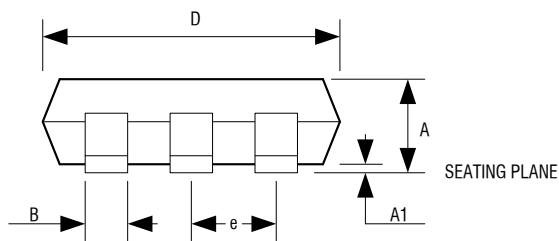

FRONT VIEW

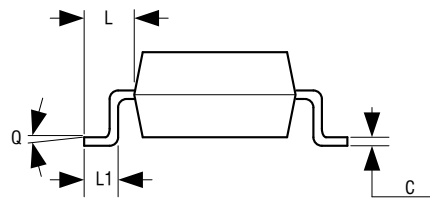

SIDE VIEW

- NOTE:
- 1.DIMENSIONS ARE IN MILLIMETERS
  - 2.DRAWING NOT TO SCALE
  - 3.DIMENSIONS ARE INCLUSIVE OF PLATING
  - 4 DIMENSIONS ARE EXCLUSIVE OF MOLD FLASH AND METAL BURR