



Features

- Low Input Capacitance
- Low Miller Charge
- Low on-resistance $R_{DS(on)}$ @ $V_{GS}=4.5\text{ V}$
- Low Input/Output Leakage
- Pb-free lead plating; RoHS compliant
-

Application

- Motor / Body Load Control

Product Summary

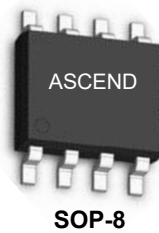
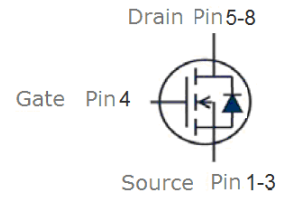
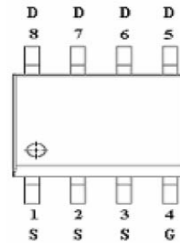

V_{DS}	65	V
$R_{DS(on),Typ}$ @ $V_{GS}=10\text{ V}$	7.0	m Ω
I_D	18	A

top view**Simplified Outline**

Absolute Maximum Ratings ($T_A=25^\circ\text{C}$ unless otherwise noted)

Parameter		Value	Unit
Drain-Source Voltage	V_{DS}	65	V
Gate-Source Voltage	V_{GS}	± 20	V
Drain Current-Continuous	$T_A=25^\circ\text{C}$	18	A
	$T_A=70^\circ\text{C}$	40	A
Drain Current-Pulsed ^{Note 1}	I_{DM}	65	A
Maximum Power Dissipation	$T_A=25^\circ\text{C}$	2.5	W
	$T_A=70^\circ\text{C}$	2.0	W
Storage Temperature Range	T_{STG}	-55 to +150	$^\circ\text{C}$
Operating Junction Temperature Range	T_J	-55 to +150	$^\circ\text{C}$

Thermal Resistance Ratings

Parameter		Conditions	Min.	Typ.	Max.	Unit
Maximum Junction-to-Ambient	$R_{\theta JA}$	Steady State	-	-	75	$^\circ\text{C}/\text{W}$
Maximum Junction-to-Ambient	$R_{\theta JA}$	$t \leq 10\text{ s}$	-	-	40	$^\circ\text{C}/\text{W}$
Maximum Junction-to-Case	$R_{\theta JC}$	Steady State	-	-	24	$^\circ\text{C}/\text{W}$

Electrical Characteristics (T_J = 25°C unless otherwise noted)

OFF CHARACTERISTICS						
Parameter	Symbol	Conditions	Min.	Typ.	Max.	Unit
Drain-Source Breakdown Voltage	BV _{DSS}	V _{GS} = 0V, I _{DS} = 250μA	65	-	-	V
Zero Gate Voltage Drain Current	I _{DSS}	V _{DS} = 48V, V _{GS} = 0V	-	-	1	μA
Gate-Body Leakage	I _{GSS}	V _{GS} = ±20V, V _{DS} = 0V	-	-	±100	nA

ON CHARACTERISTICS						
Parameter	Symbol	Conditions	Min.	Typ.	Max.	Unit
Gate Threshold Voltage	V _{GS(TH)}	V _{DS} = V _{GS} , I _{DS} = 250μA	1.2	1.7	2.5	V
Drain-Source On-State Resistance	R _{DS(ON)}	V _{GS} = 10V, I _{DS} = 12A	-	-	7.5	mΩ
Drain-Source On-State Resistance	R _{DS(ON)}	V _{GS} = 4.5V, I _{DS} = 9A	-	-	9	mΩ
Forward Transconductance	g _{fs}	V _{DD} = 10V, I _{DD} = 6A	-	11	-	S

DYNAMIC CHARACTERISTICS						
Parameter	Symbol	Conditions	Min.	Typ.	Max.	Unit
Input Capacitance	C _{iss}	V _{DS} = 30V, V _{GS} = 0V, f = 1MHz	-	3450	-	pF
Output Capacitance	C _{oss}		-	310	-	
Reverse Transfer Capacitance	C _{rss}		-	115	-	

SWITCHING CHARACTERISTICS						
Parameter	Symbol	Conditions	Min.	Typ.	Max.	Unit
Turn-On Delay Time	T _{d(on)}	V _{GS} = 10V, V _{DS} = 30V, R _L = 5Ω, R _{GEN} = 3Ω	-	28	-	ns
Rise Time	t _r		-	32	-	
Turn-Off Delay Time	T _{d(off)}		-	98	-	
Fall Time	t _f		-	68	-	
Total Gate Charge	Q _g	V _{GS} = 10V, V _{DS} = 30V, I _D = 10A	-	75	-	nC
Gate to Source Gate Charge	Q _{gs}		-	19	-	
Gate to Drain "Miller" Charge	Q _{gd}		-	26	-	
Gate resistance	R _g	V _{DS} = 0V, V _{GS} = 0V, f = 1MHz	-	1.2	-	Ω

DRAIN-SOURCE DIODE CHARACTERISTICS AND MAXIMUM RATINGS						
Parameter	Symbol	Conditions	Min.	Typ.	Max.	Unit
Drain-Source Diode Forward Voltage	V _{SD}	V _{GS} = 0V, I _S = 1A	-	-	1.3	V
Continuous Source Current	I _S	I _F = 12A, dI/dt = 500A/μs	-	13	-	A
Pulsed Source Current	I _{SM}		-	45	-	A

- Notes:**
- Pulse Test: Pulse Width ≤ 300μs, Duty Cycle ≤ 2%.
 - R_{θJA} is the sum of the junction-to-case and case-to-ambient thermal resistance where the case thermal reference is defined as the solder mounting surface of the drain pins. R_{θJC} is guaranteed by design while R_{θCA} is determined by the user's board design. R_{θJA} shown below for single device operation on FR-4 in still air.

Typical Characteristics

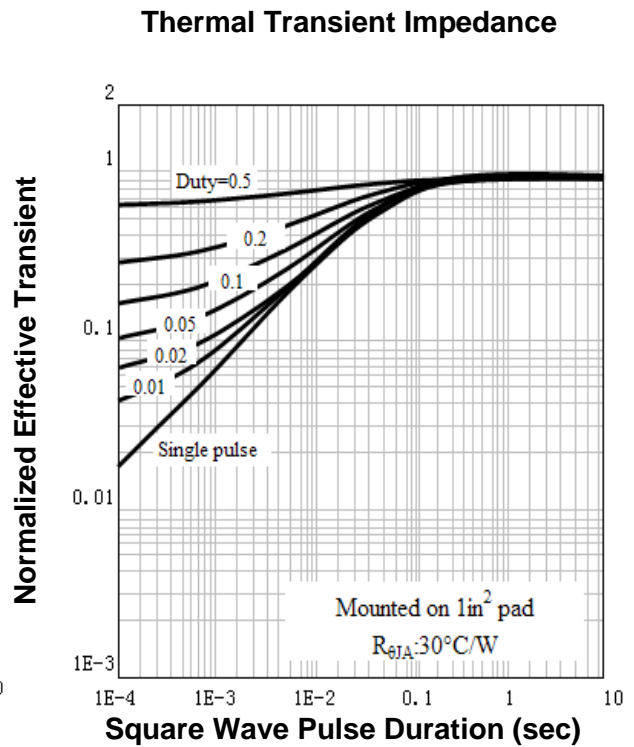
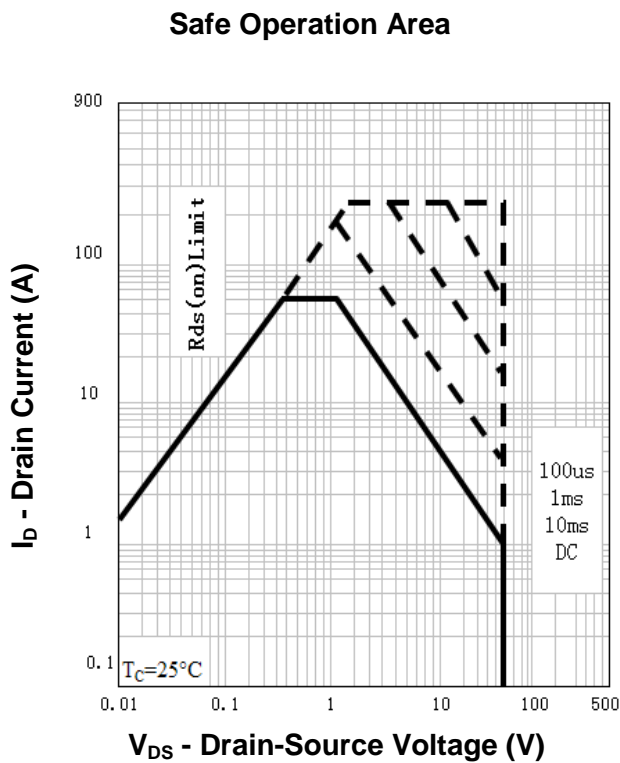
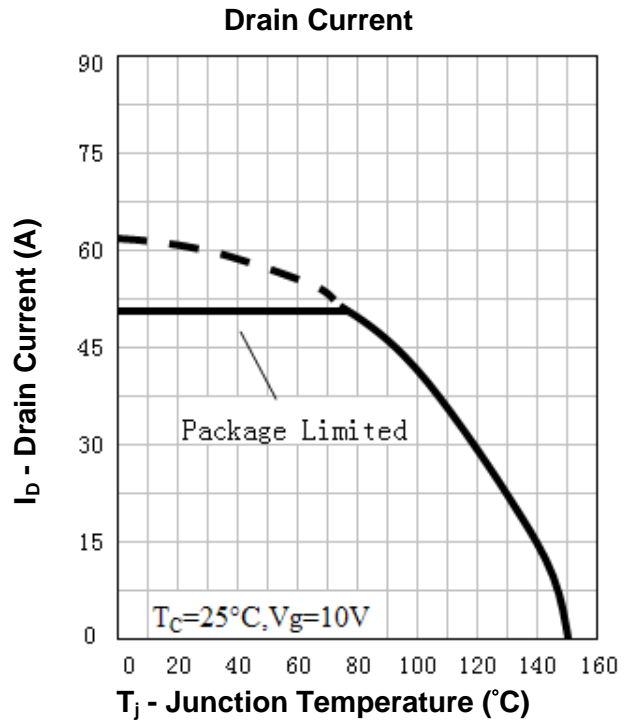
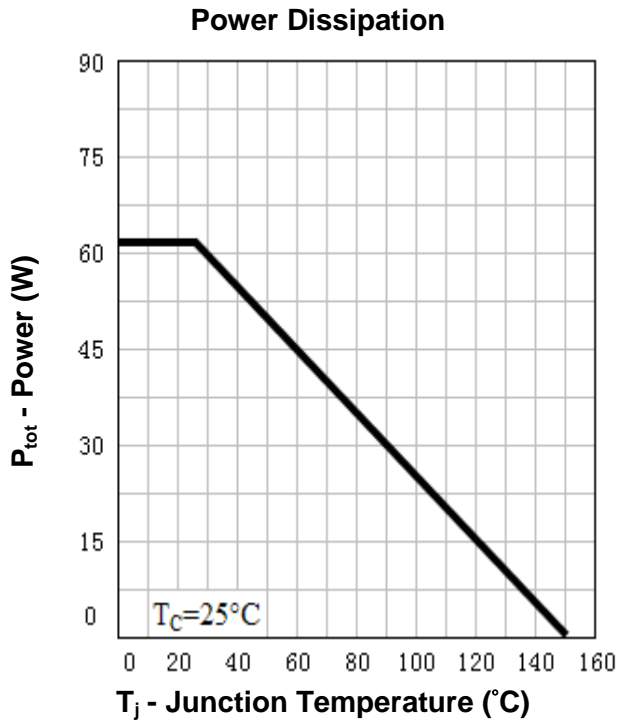

Typical Characteristics

Output Characteristics

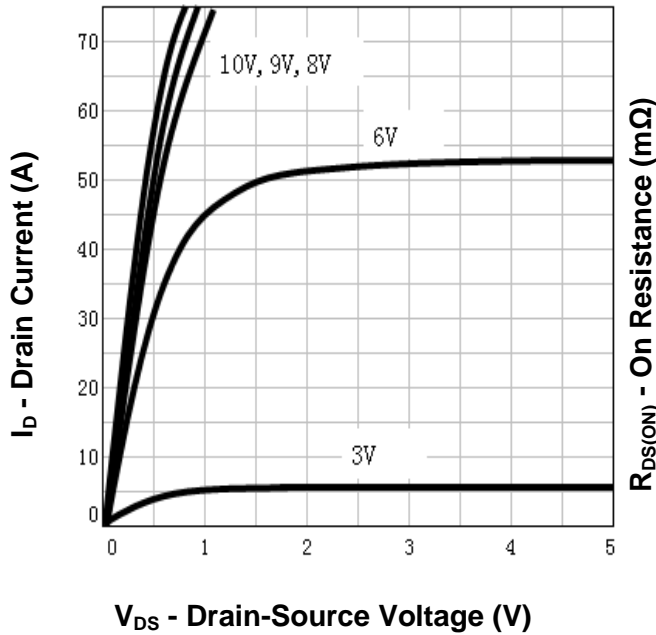

Drain-Source On Resistance

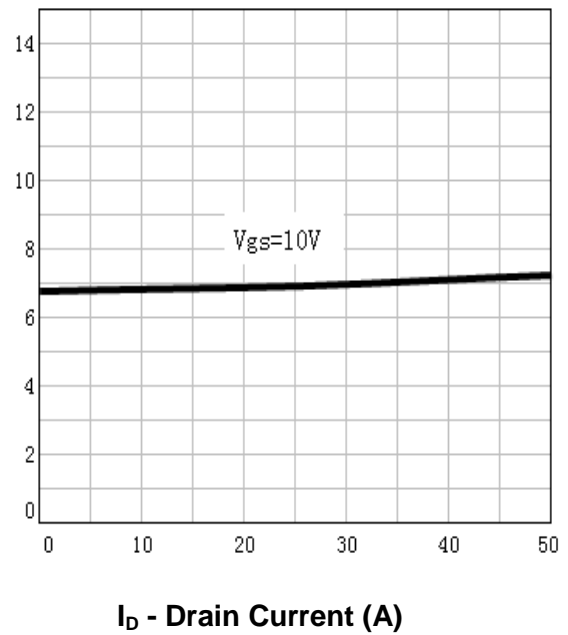

Drain-Source On Resistance

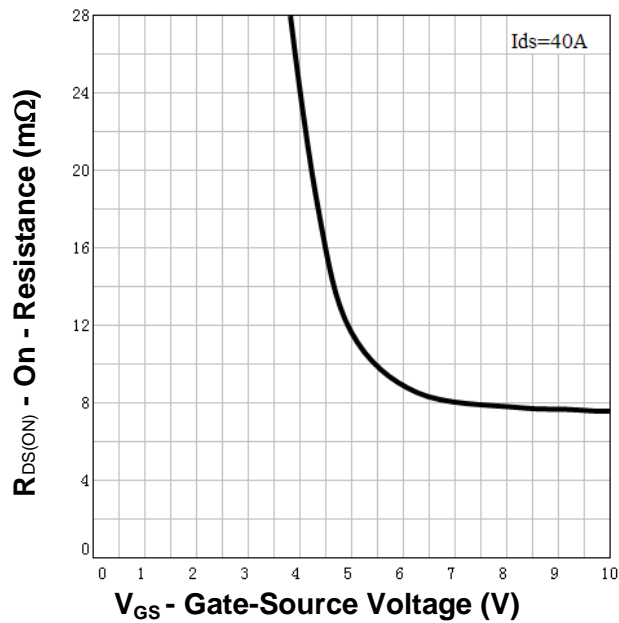

Gate Threshold Voltage

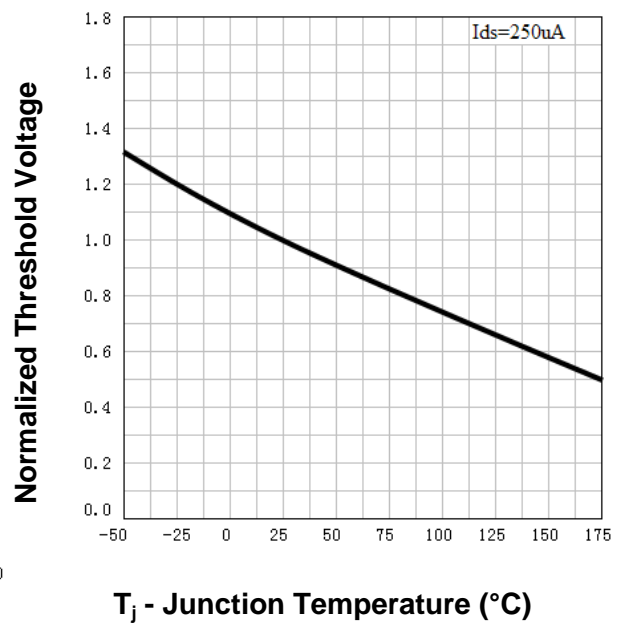

Typical Characteristics

Drain-Source On Resistance

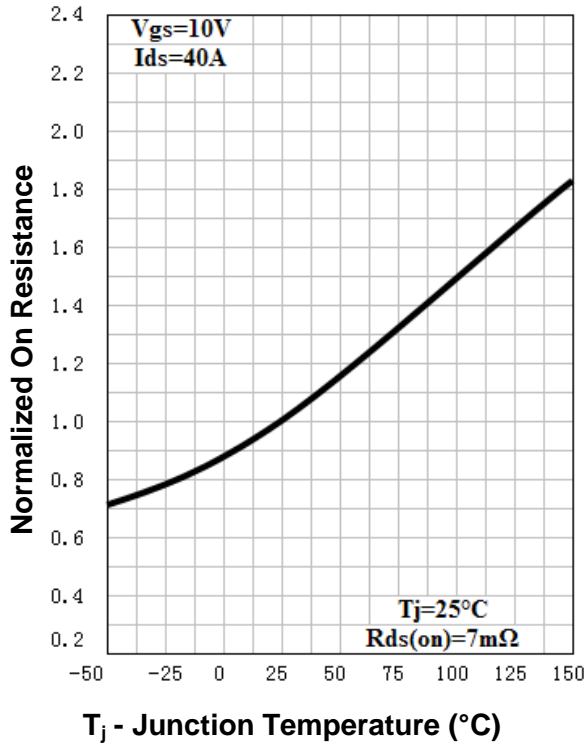

Source-Drain Diode Forward

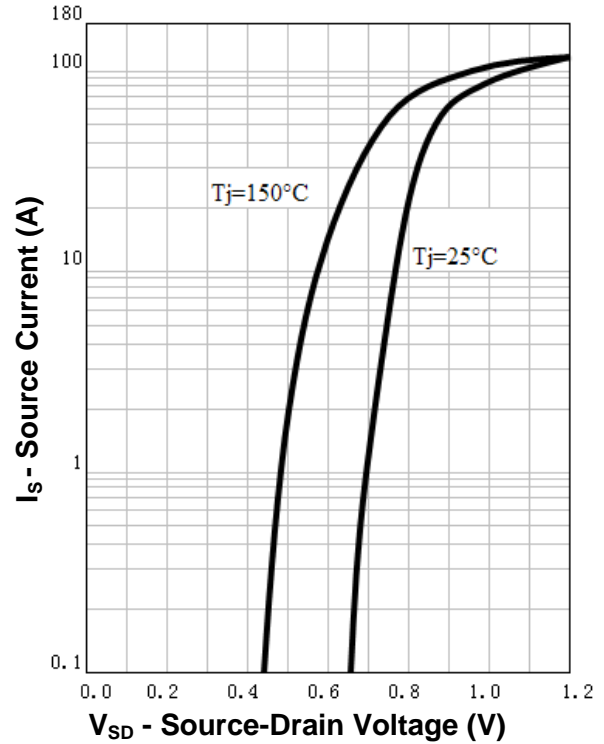

Capacitance

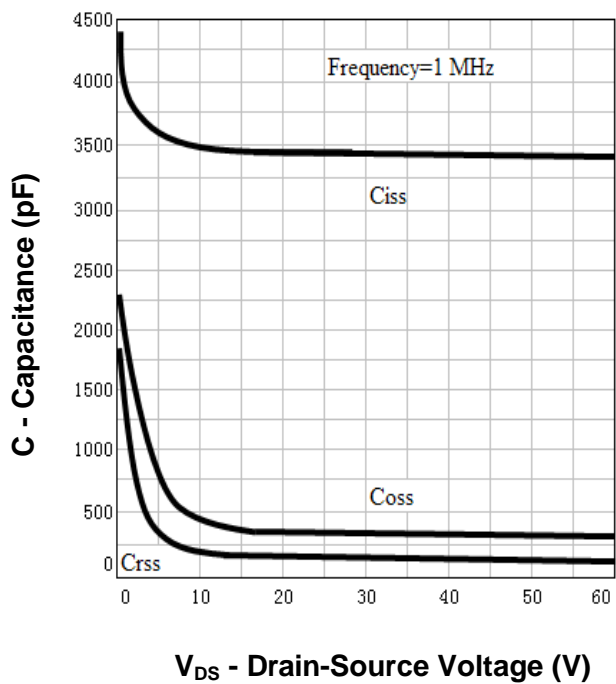

Gate Charge

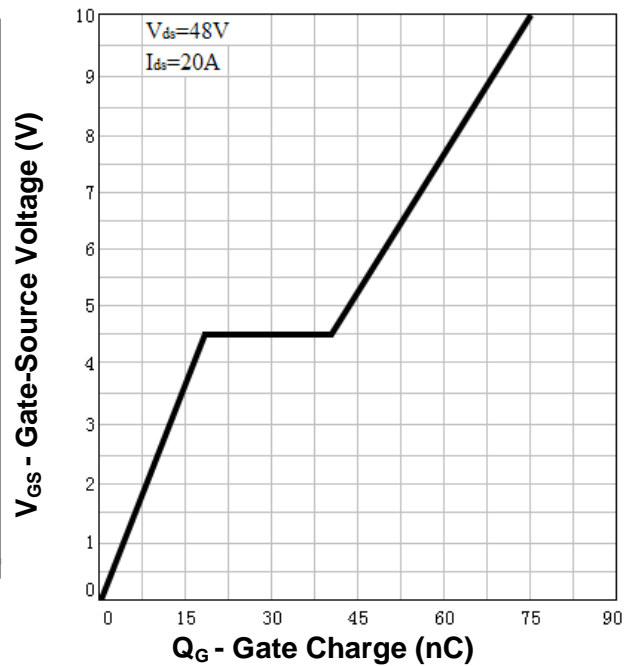

Avalanche Test Circuit and Waveforms

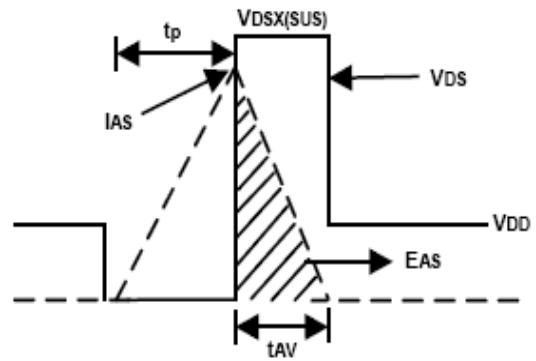
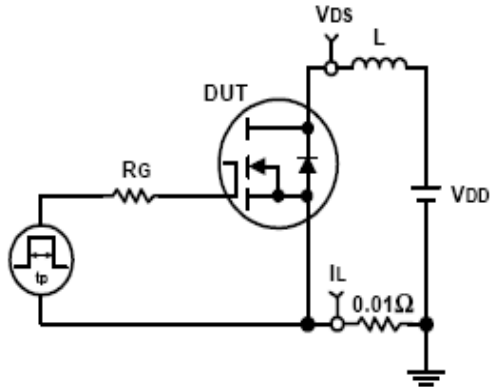

Switching Time Test Circuit and Waveforms

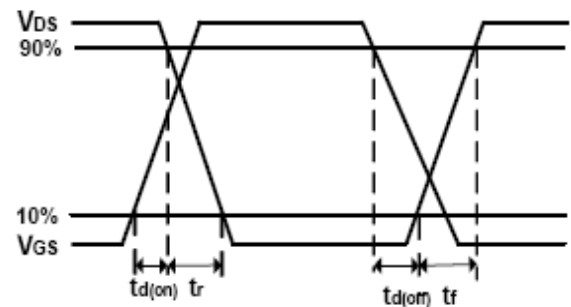
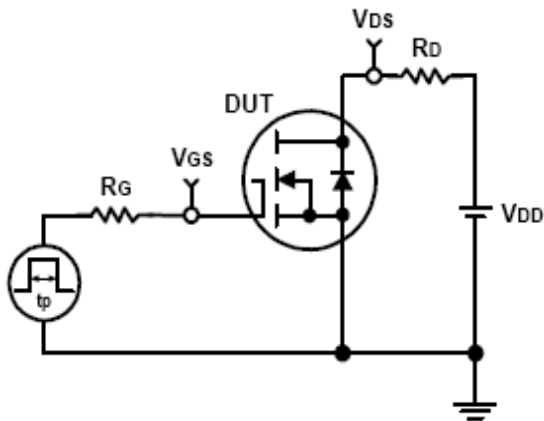

Ordering and Marking Information

Device	Marking	Package	Packing	Quantity
ASDM65N18S	65N18	SOP-8	Tape&Reel	4000

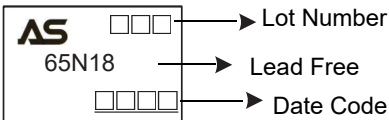
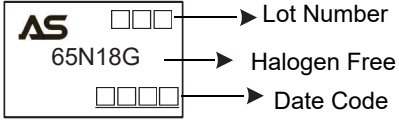
PACKAGE	MARKING
SOP-8	 <p>AS □□□ → Lot Number 65N18 → Lead Free □□□□ → Date Code</p>  <p>AS □□□ → Lot Number 65N18G → Halogen Free □□□□ → Date Code</p>

Ordering Number		Package
Lead Free	Halogen Free	
ASDM65N18-S-R	ASDM65N18G-S-R	SOP-8

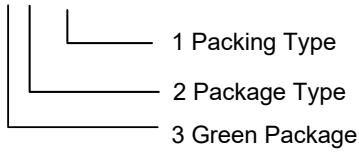
<p>ASDM65N18G-S-R</p>  <p>1 Packing Type 2 Package Type 3 Green Package</p>	<p>1 R:Tape Reel 2 S:SOP-8 3 blank: Lead Free G:Halogen Free</p>
--	--

SOP-8 PACKAGE IN FORMATION

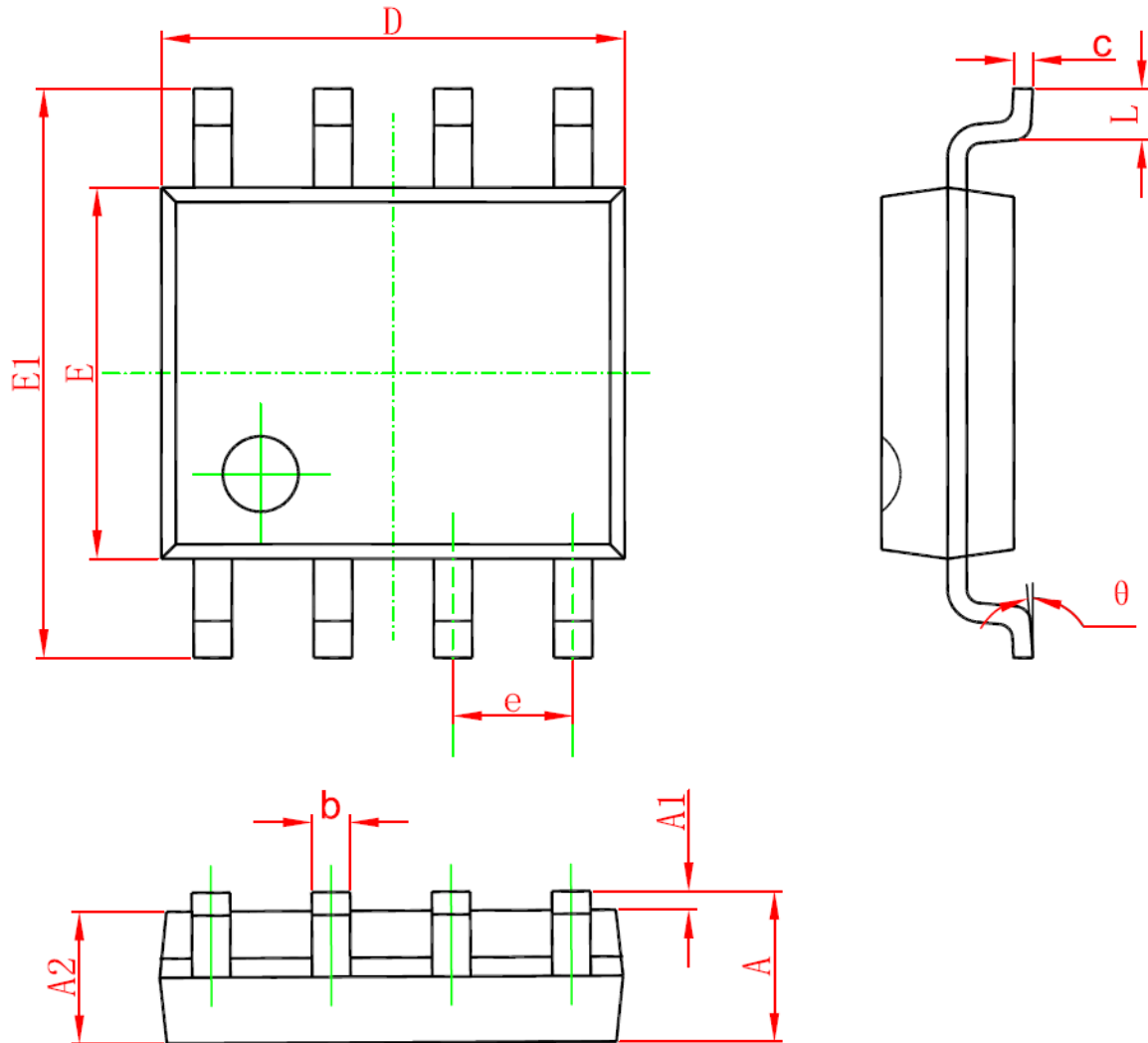

Symbol	Dimensions In Millimeters		Dimensions In Inches	
	Min	Max	Min	Max
A	1.350	1.750	0.053	0.069
A1	0.100	0.250	0.004	0.010
A2	1.350	1.550	0.053	0.061
b	0.330	0.510	0.013	0.020
c	0.170	0.250	0.006	0.010
D	4.700	5.100	0.185	0.200
E	3.800	4.000	0.150	0.157
E1	5.800	6.200	0.228	0.244
e	1.270 (BSC)		0.050 (BSC)	
L	0.400	1.270	0.016	0.050
θ	0°	8°	0°	8°

**IMPORTANT NOTICE**

Xi'an Ascend Semiconductor incorporated MAKES NO WARRANTY OF ANY KIND, EXPRESS OR IMPLIED, WITH REGARDS TO THIS DOCUMENT, INCLUDING, BUT NOT LIMITED TO, THE IMPLIED WARRANTIES OF MERCHANTABILITY AND FITNESS FOR A PARTICULAR PURPOSE (AND THEIR EQUIVALENTS UNDER THE LAWS OF ANY JURISDICTION).

Xi'an Ascend Semiconductor Incorporated and its subsidiaries reserve the right to make modifications, enhancements, improvements, corrections or other changes without further notice to this document and any product described herein. Xi'an Ascend Semiconductor Incorporated does not assume any liability arising out of the application or use of this document or any product described herein; neither does Xi'an Ascend Semiconductor Incorporated convey any license under its patent or trademark rights, nor the rights of others. Any Customer or user of this document or products described herein in such applications shall assume

all risks of such use and will agree to hold Ascendsemi Incorporated and all the companies whose products are represented on Xi'an Ascend Semiconductor Incorporated website, harmless against all damages.

Xi'an Ascend Semiconductor Incorporated does not warrant or accept any liability whatsoever in respect of any products purchased through unauthorized sales channel. Should Customers purchase or use Xi'an Ascend Semiconductor Incorporated products for any unintended or unauthorized application, Customers shall indemnify and hold Xi'an Ascend Semiconductor Incorporated and its representatives harmless against all claims, damages, expenses, and attorney fees arising out of, directly or indirectly, any claim of personal injury or death associated with such unintended or unauthorized application.

www.ascendsemi.com