



Dual channel 40V N-Channel MOSFET

General Description

The LPM9042 is a dual channel MOSFET, which uses advanced trench technology to provide excellent $R_{DS(ON)}$ with low gate charge. Each channel has all the features. This is an all purpose device that is suitable for use in a wide range of power conversion applications.

Features

- ◆ 100% EAS Guaranteed
- ◆ Green Device Available
- ◆ Super Low Gate Charge
- ◆ Excellent CdV/dt effect decline
- ◆ Advanced high cell density Trench technology

Order Information

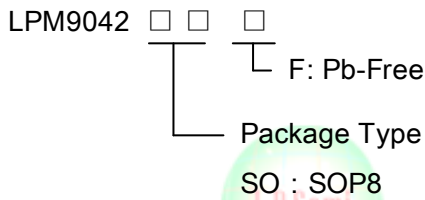

Applications

- ✧ Driver for Relay, Solenoid, Motor, LED etc.
- ✧ DC-DC converter circuit
- ✧ Power Switch
- ✧ Load Switch
- ✧ Charging

Pin Configurations

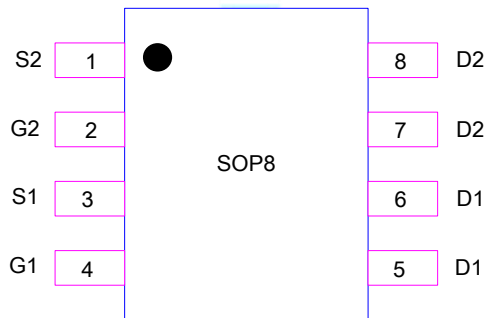

Pin Description

Pin Number	Pin Description
1	S2
2	G2
3	S1
4	G1
5	D1
6	
7	D2
8	



Absolute Maximum Ratings

Channel 1 and channel 2 have the same maximum ratings

Parameter		Symbol	10 Sec	Steady State	Unit
Drain-Source Voltage		V_{DS}	40		V
Gate-Source Voltage		V_{GS}	± 20		
Continuous Drain Current	TA=25°C	I_D	13.5	10	A
	TA=70°C		10.8	8	
Pulsed Drain Current		I_{DM}	120		
Avalanche Current		I_{AR}	23		
Repetitive avalanche energy L=0.3mH		E_{AR}	79		mJ
Power Dissipation	TA=25°C	P_D	3.1	1.7	W
	TA=70°C		2.0	1.1	
Junction and Storage Temperature Range		T_J, T_{STG}	-55 to 150		°C

Thermal resistance ratings

Parameter		Symbol	TYP	MAX	Unit
Junction-to-Case Thermal Resistance	$t \leq 10s$	$R_{\theta JA}$	31	40	°C/W
Junction-to-Case Thermal Resistance	Steady State		59	75	°C/W
Maximum Junction-to-Lead	Steady State	$R_{\theta JL}$	16	24	°C/W



Electrical Characteristics

Electrical Characteristics (T_J=25°C unless otherwise noted)
Channel 1 and channel 2 have the same electrical characteristics

Symbol	Parameter	Conditions	Min	Typ	Max	Units
STATIC PARAMETERS						
BV _{DSS}	Drain-Source Breakdown Voltage	I _D =250μA, V _{GS} =0V	40			V
I _{DSS}	Zero Gate Voltage Drain Current	V _{DS} =40V, V _{GS} =0V T _J =55°C			1 5	μA
I _{GSS}	Gate-Body leakage current	V _{DS} =0V, V _{GS} =±20V			±100	nA
V _{GS(th)}	Gate Threshold Voltage	V _{DS} =V _{GS} , I _D =25μA	1.7	2.2	3	V
I _{D(ON)}	On state drain current	V _{GS} =10V, V _{DS} =5V	120			A
R _{DS(ON)}	Static Drain-Source On-Resistance	V _{GS} =10V, I _D =10A T _J =125°C		8.2	10	mΩ
				12.5	16	
		V _{GS} =4.5V, I _D =8A		10	12.5	
g _{FS}	Forward Transconductance	V _{DS} =5V, I _D =10A		75		S
V _{SD}	Diode Forward Voltage	I _S =1A, V _{GS} =0V		0.72	1	V
I _S	Maximum Body-Diode Continuous Current				2.5	A
DYNAMIC PARAMETERS						
C _{iss}	Input Capacitance	V _{GS} =0V, V _{DS} =20V, f=1MHz		1500	1950	pF
C _{oss}	Output Capacitance			215		pF
C _{rss}	Reverse Transfer Capacitance			135		pF
R _g	Gate resistance	V _{GS} =0V, V _{DS} =0V, f=1MHz	2	3.5	5	Ω
SWITCHING PARAMETERS						
Q _g (10V)	Total Gate Charge	V _{GS} =10V, V _{DS} =20V, I _D =10A		27.2	37	nC
Q _g (4.5V)	Total Gate Charge			13.6	18	nC
Q _{gs}	Gate Source Charge			4.5		nC
Q _{gd}	Gate Drain Charge			6.4		nC
t _{D(on)}	Turn-On DelayTime	V _{GS} =10V, V _{DS} =20V, R _L = 2Ω, R _{GEN} =3Ω		6.4		ns
t _r	Turn-On Rise Time			17.2		ns
t _{D(off)}	Turn-Off DelayTime			29.6		ns
t _f	Turn-Off Fall Time			16.8		ns
t _{rr}	Body Diode Reverse Recovery Time	I _F =10A, dI/dt=100A/μs		30	40	ns
Q _{rr}	Body Diode Reverse Recovery Charge	I _F =10A, dI/dt=100A/μs		19		nC



Typical Characteristics

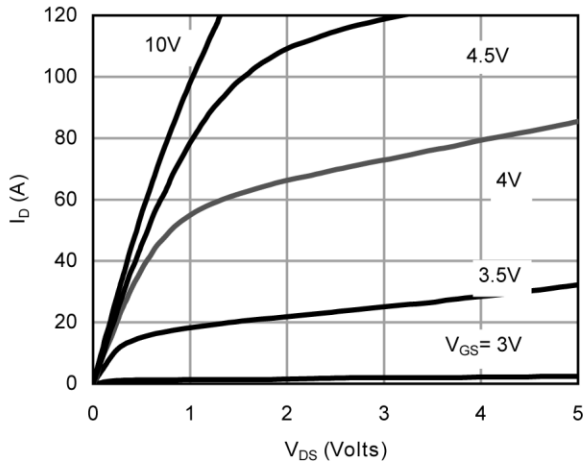

Figure 1: On-Region Characteristics

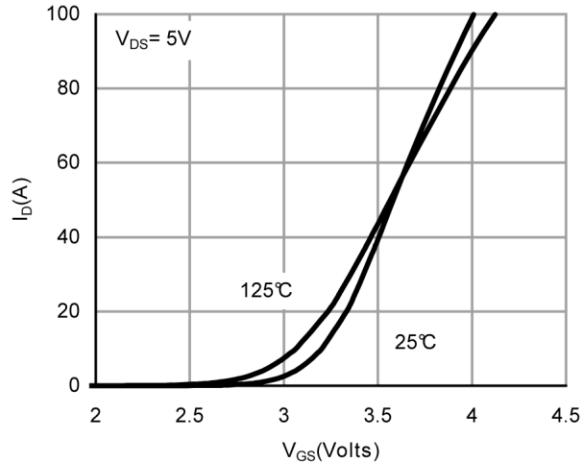

Figure 2: Transfer Characteristics

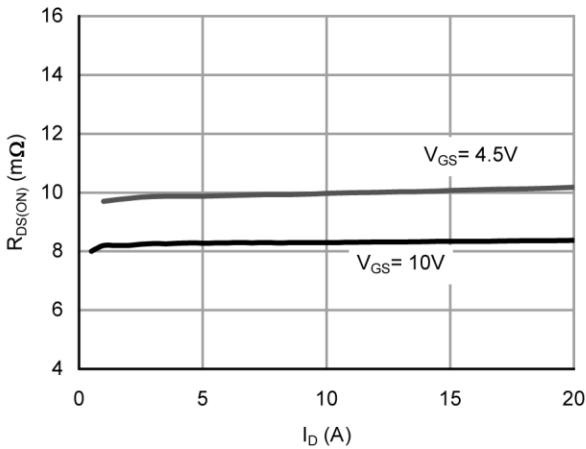

Figure 3: On-Resistance vs. Drain Current and Gate Voltage

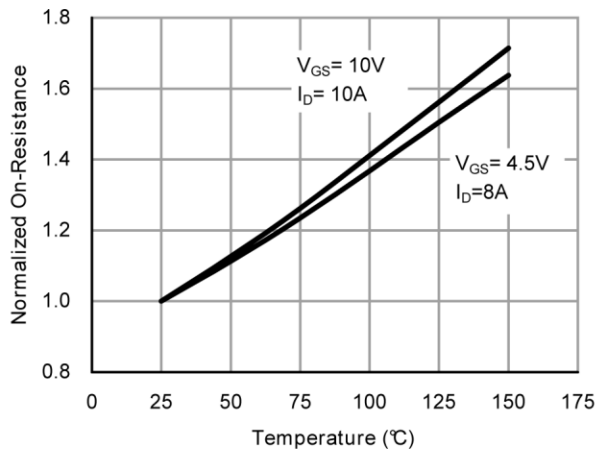

Figure 4: On-Resistance vs. Junction Temperature

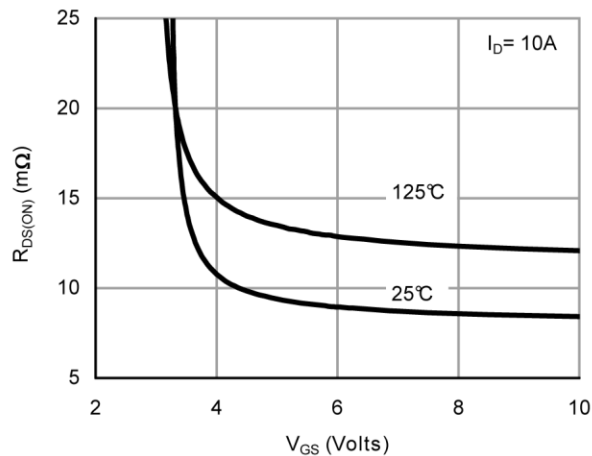

Figure 5: On-Resistance vs. Gate-Source Voltage

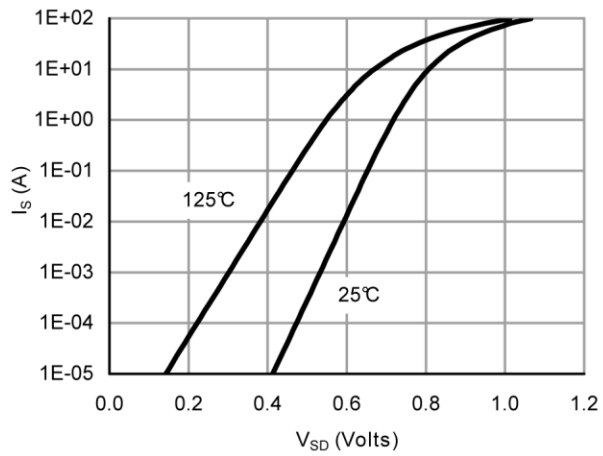

Figure 6: Body-Diode Characteristics

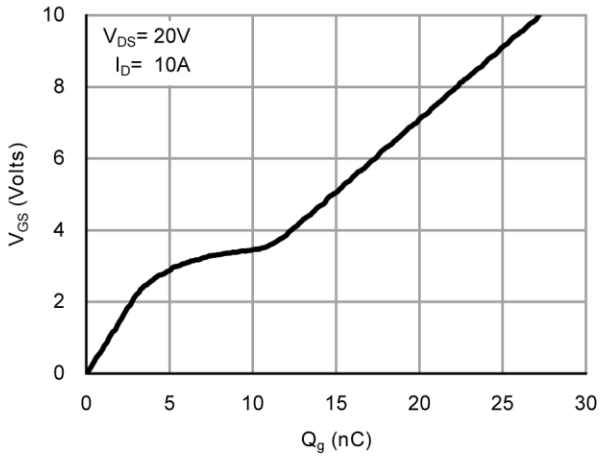

Figure 7: Gate-Charge Characteristics

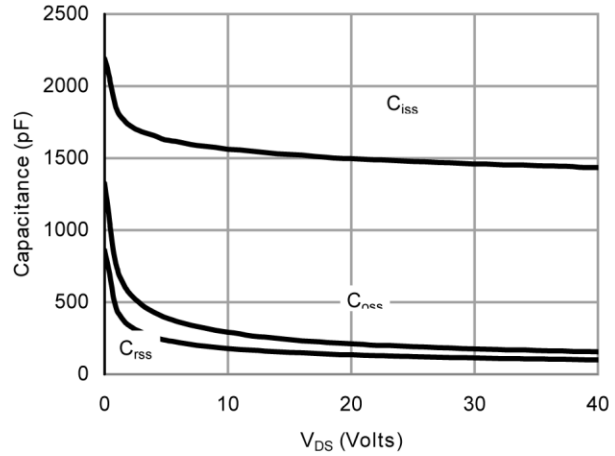

Figure 8: Capacitance Characteristics

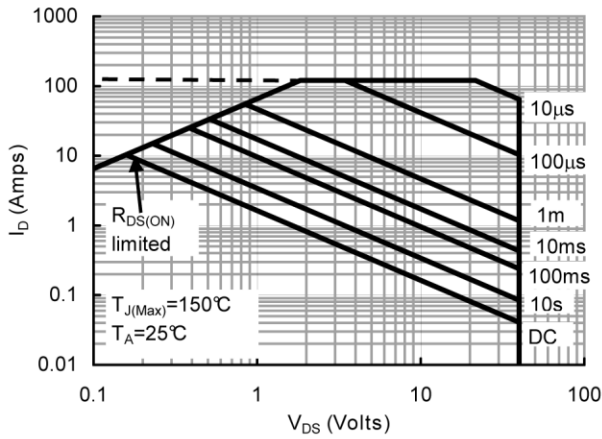

Figure 9: Maximum Forward Biased Safe Operating Area (Note E)

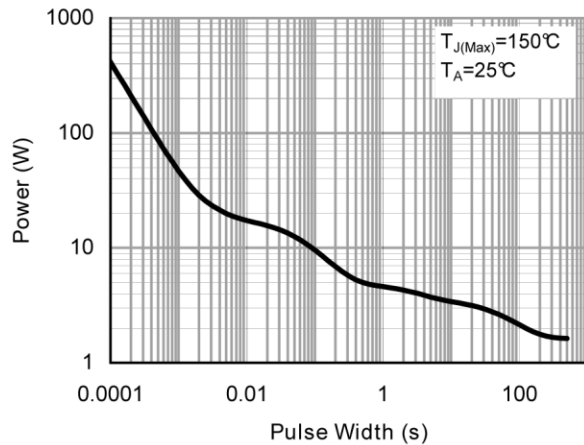

Figure 10: Single Pulse Power Rating Junction-to-Ambient (Note E)

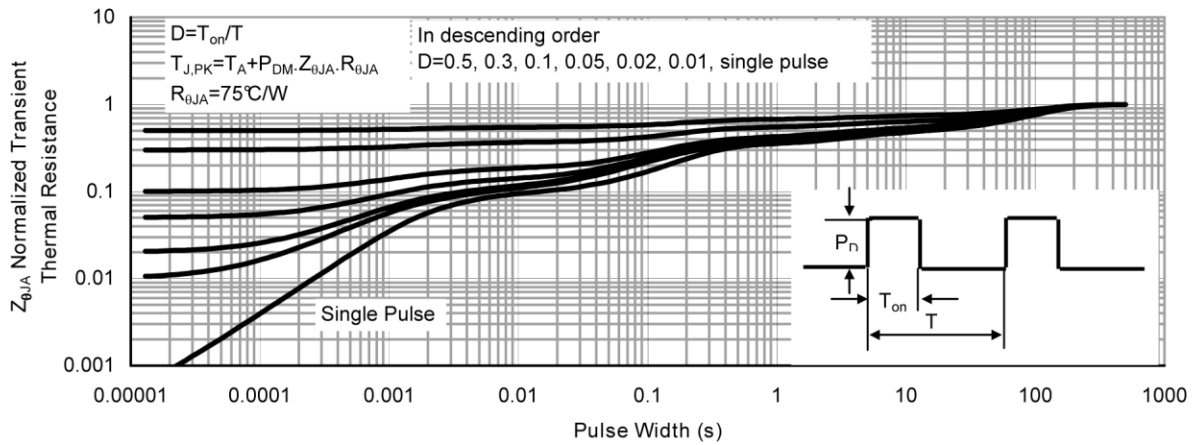
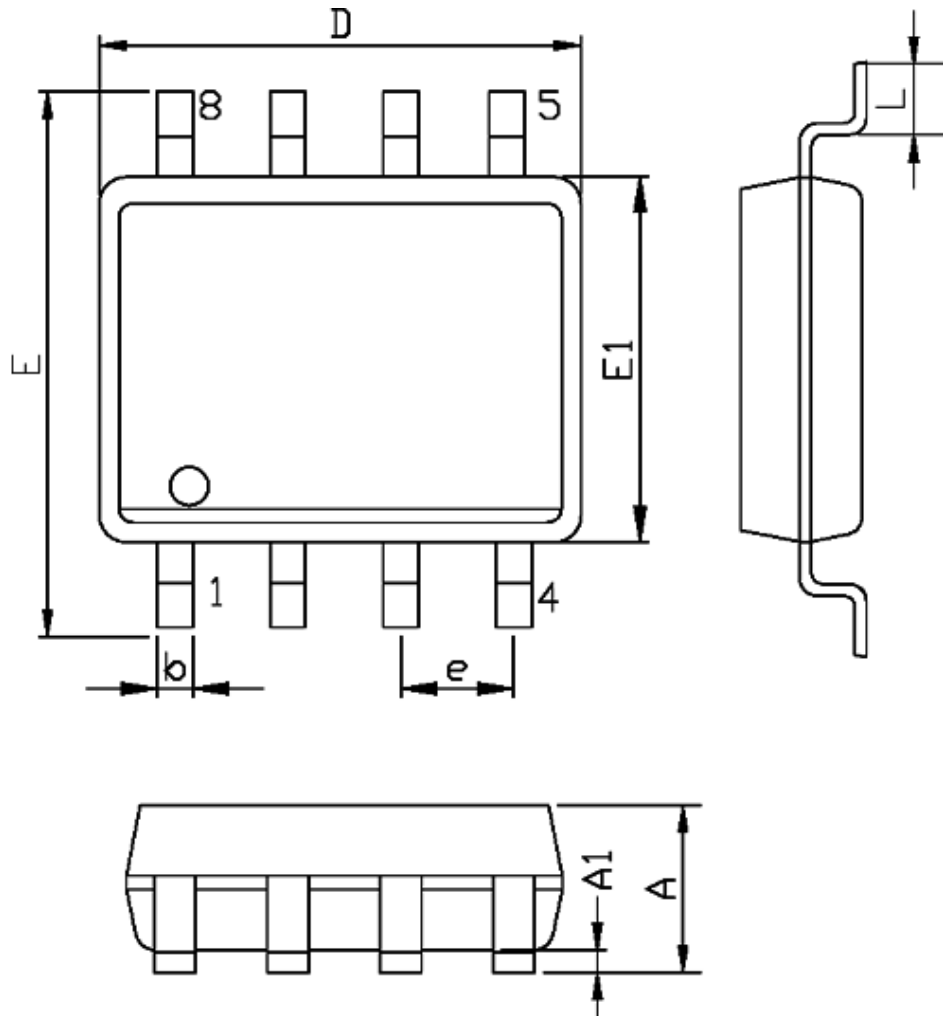

Figure 11: Normalized Maximum Transient Thermal Impedance (Note E)



Packaging Information

SOP8



SYMBOLS	MILLIMETERS		INCHES	
	MIN.	MAX.	MIN.	MAX.
A	1.35	1.75	0.053	0.069
A1	0.10	0.25	0.004	0.010
D	4.90		0.193	
E	5.80	6.20	0.228	0.244
E1	3.90		0.153	
L	0.40	1.27	0.016	0.050
b	0.31	0.51	0.012	0.020
e	1.27		0.050	