



### 30V N-Channel MOSFET

#### General Description

The LPM9040A uses advanced trench technology to provide excellent  $R_{DS(ON)}$  with low gate charge. This is an all purpose device that is suitable for use in a wide range of power conversion applications.

#### Features

- ◆ 100% EAS Guaranteed
- ◆ Green Device Available
- ◆ Super Low Gate Charge
- ◆ Excellent CdV/dt effect decline
- ◆ Advanced high cell density Trench technology

#### Order Information

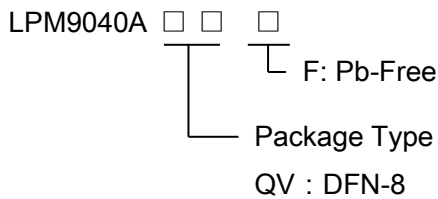

#### Applications

- ✧ Driver for Relay, Solenoid, Motor, LED etc.
- ✧ DC-DC converter circuit
- ✧ Power Switch
- ✧ Load Switch
- ✧ Charging

#### Pin Description

Pin Number	Pin Description
1	Source
2	
3	
4	Gate
5	Drain
6	
7	
8	

#### Pin Configurations

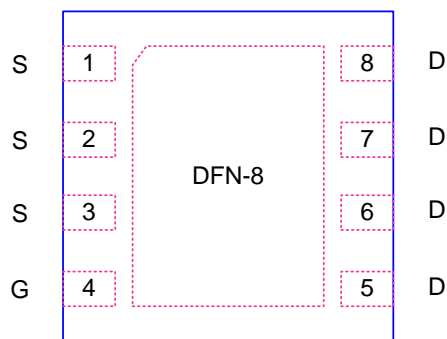

#### Marking Information

Part	Marking	Package	Shipping
LPM9040AQVF	LPS 9040A YWX	DFN-8	5K/REEL
Marking indication: Y:Production year W:Production week X:Production batch.			



## Absolute Maximum Ratings

Parameter		Symbol	10 Sec	Steady State	Unit
Drain-Source Voltage		$V_{DS}$	30		V
Gate-Source Voltage		$V_{GS}$	$\pm 20$		
Continuous Drain Current	TA=25°C	$I_D$	13.5	10	A
	TA=70°C		10.8	8	
Pulsed Drain Current		$I_{DM}$	120		
Avalanche Current		$I_{AR}$	23		
Repetitive avalanche energy L=0.3mH		$E_{AR}$	79		mJ
Power Dissipation	TA=25°C	$P_D$	3.1	1.7	W
	TA=70°C		2.0	1.1	
Junction and Storage Temperature Range		$T_J, T_{STG}$	-55 to 150		°C

## Thermal resistance ratings

Parameter		Symbol	TYP	MAX	Unit
Junction-to-Case Thermal Resistance	$t \leq 10s$	$R_{\theta JA}$	31	40	°C/W
Junction-to-Case Thermal Resistance	Steady State		59	75	°C/W
Maximum Junction-to-Lead	Steady State	$R_{\theta JL}$	16	24	°C/W



## Electrical Characteristics

Electrical Characteristics (T<sub>J</sub>=25°C unless otherwise noted)

Symbol	Parameter	Conditions	Min	Typ	Max	Units
<b>STATIC PARAMETERS</b>						
BV <sub>DSS</sub>	Drain-Source Breakdown Voltage	I <sub>D</sub> =250μA, V <sub>GS</sub> =0V	30			V
I <sub>DSS</sub>	Zero Gate Voltage Drain Current	V <sub>DS</sub> =40V, V <sub>GS</sub> =0V T <sub>J</sub> =55°C			1 5	μA
I <sub>GSS</sub>	Gate-Body leakage current	V <sub>DS</sub> =0V, V <sub>GS</sub> =±20V			±100	nA
V <sub>GS(th)</sub>	Gate Threshold Voltage	V <sub>DS</sub> =V <sub>GS</sub> , I <sub>D</sub> =25μA	1.7	2.2	3	V
I <sub>D(ON)</sub>	On state drain current	V <sub>GS</sub> =10V, V <sub>DS</sub> =5V	120			A
R <sub>DS(ON)</sub>	Static Drain-Source On-Resistance	V <sub>GS</sub> =10V, I <sub>D</sub> =10A T <sub>J</sub> =125°C		8.2	10	mΩ
		V <sub>GS</sub> =4.5V, I <sub>D</sub> =8A		10	12.5	
g <sub>FS</sub>	Forward Transconductance	V <sub>DS</sub> =5V, I <sub>D</sub> =10A		75		S
V <sub>SD</sub>	Diode Forward Voltage	I <sub>S</sub> =1A, V <sub>GS</sub> =0V		0.72	1	V
I <sub>S</sub>	Maximum Body-Diode Continuous Current				2.5	A
<b>DYNAMIC PARAMETERS</b>						
C <sub>iss</sub>	Input Capacitance	V <sub>GS</sub> =0V, V <sub>DS</sub> =20V, f=1MHz		1500	1950	pF
C <sub>oss</sub>	Output Capacitance		215		pF	
C <sub>rss</sub>	Reverse Transfer Capacitance		135		pF	
R <sub>g</sub>	Gate resistance	V <sub>GS</sub> =0V, V <sub>DS</sub> =0V, f=1MHz	2	3.5	5	Ω
<b>SWITCHING PARAMETERS</b>						
Q <sub>g</sub> (10V)	Total Gate Charge	V <sub>GS</sub> =10V, V <sub>DS</sub> =20V, I <sub>D</sub> =10A		27.2	37	nC
Q <sub>g</sub> (4.5V)	Total Gate Charge		13.6	18	nC	
Q <sub>gs</sub>	Gate Source Charge		4.5		nC	
Q <sub>gd</sub>	Gate Drain Charge		6.4		nC	
t <sub>D(on)</sub>	Turn-On DelayTime	V <sub>GS</sub> =10V, V <sub>DS</sub> =20V, R <sub>L</sub> = 2Ω, R <sub>GEN</sub> =3Ω		6.4		ns
t <sub>r</sub>	Turn-On Rise Time		17.2		ns	
t <sub>D(off)</sub>	Turn-Off DelayTime		29.6		ns	
t <sub>f</sub>	Turn-Off Fall Time		16.8		ns	
t <sub>rr</sub>	Body Diode Reverse Recovery Time	I <sub>F</sub> =10A, di/dt=100A/μs		30	40	ns
Q <sub>rr</sub>	Body Diode Reverse Recovery Charge	I <sub>F</sub> =10A, di/dt=100A/μs		19		nC



### Typical Characteristics

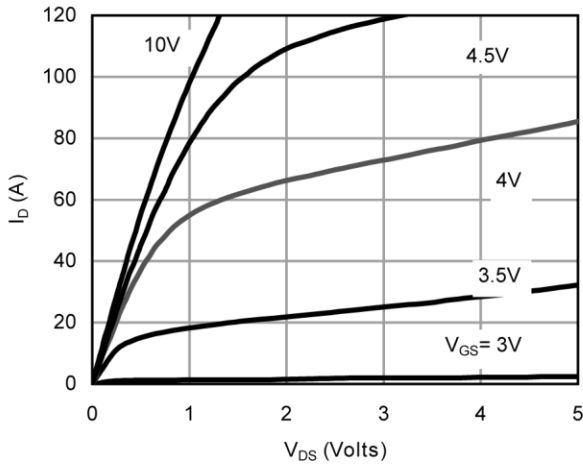

Figure 1: On-Region Characteristics

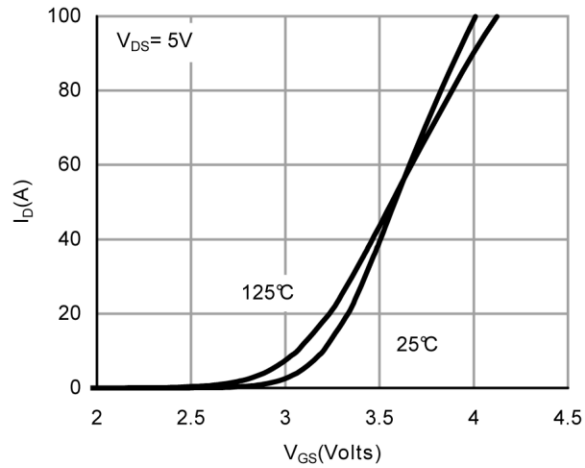

Figure 2: Transfer Characteristics

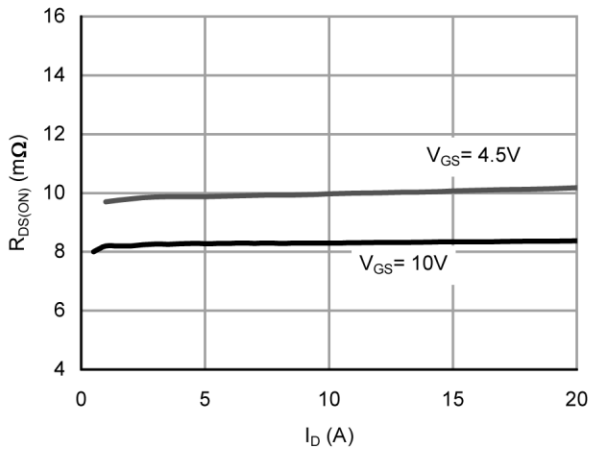

Figure 3: On-Resistance vs. Drain Current and Gate Voltage

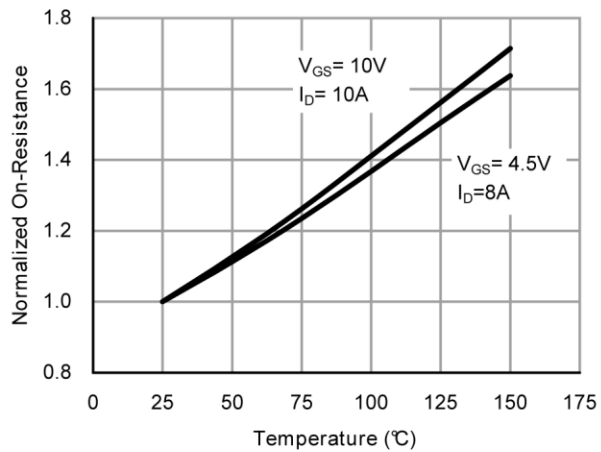

Figure 4: On-Resistance vs. Junction Temperature

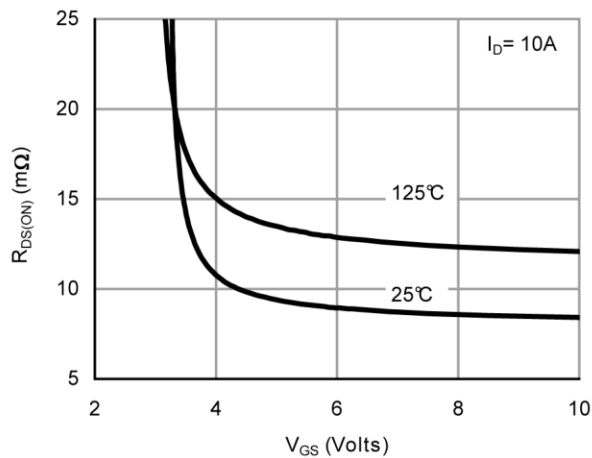

Figure 5: On-Resistance vs. Gate-Source Voltage

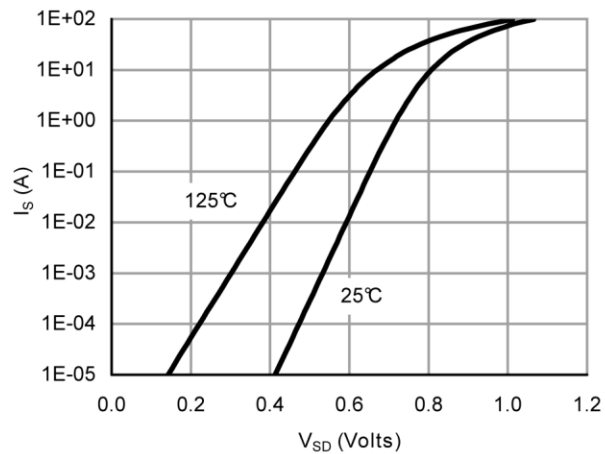

Figure 6: Body-Diode Characteristics

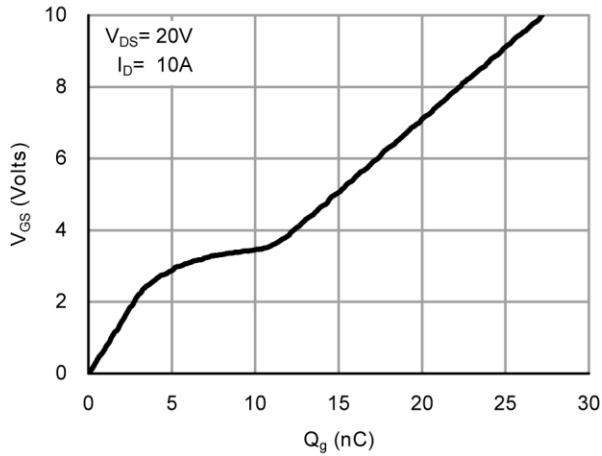

Figure 7: Gate-Charge Characteristics

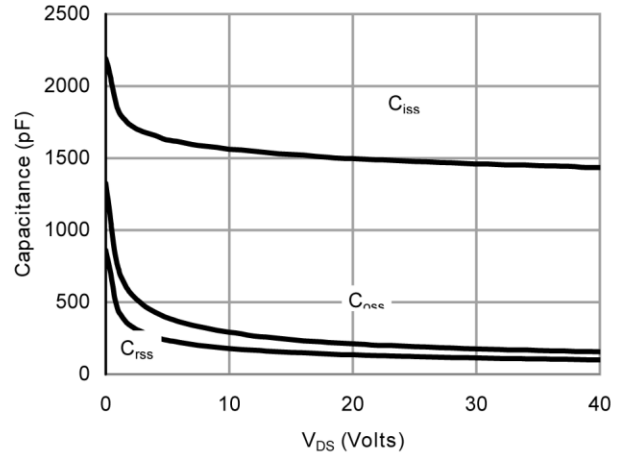

Figure 8: Capacitance Characteristics

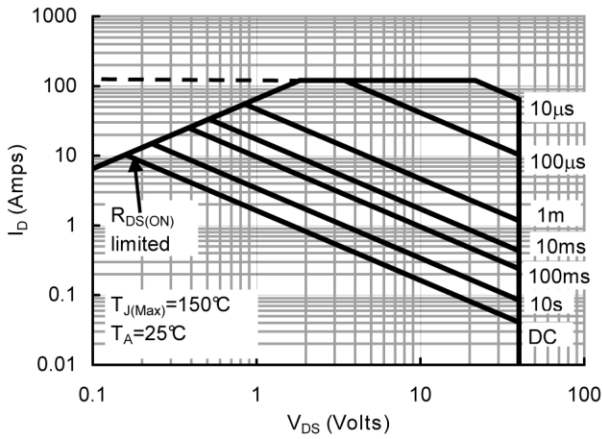

Figure 9: Maximum Forward Biased Safe Operating Area (Note E)

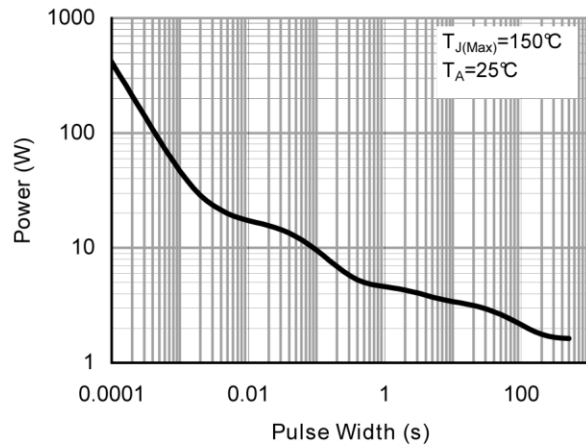

Figure 10: Single Pulse Power Rating Junction-to-Ambient (Note E)

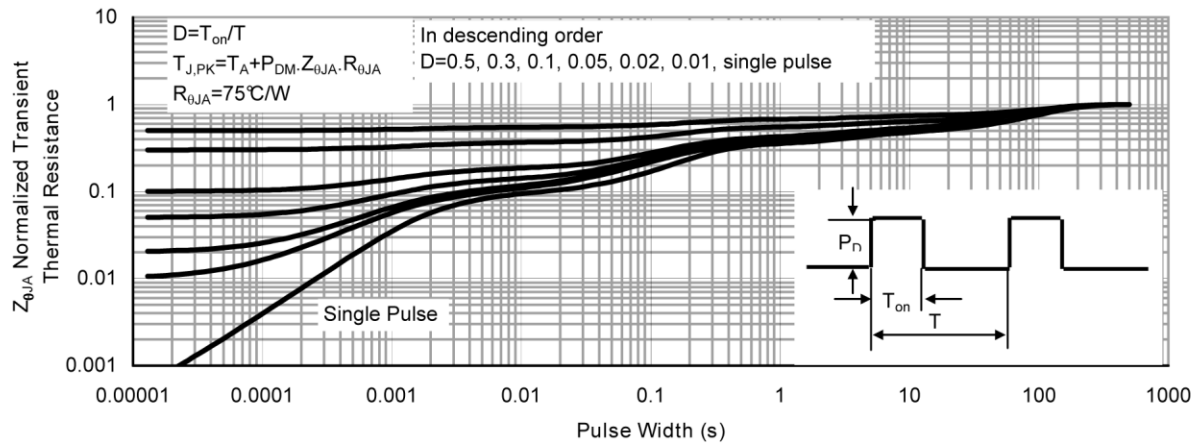
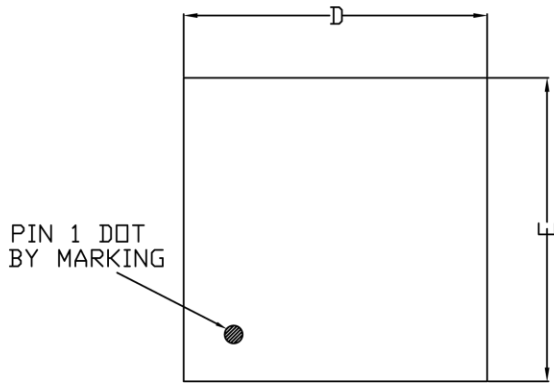

Figure 11: Normalized Maximum Transient Thermal Impedance (Note E)



### Packaging Information

### DFN-8



TOP VIEW

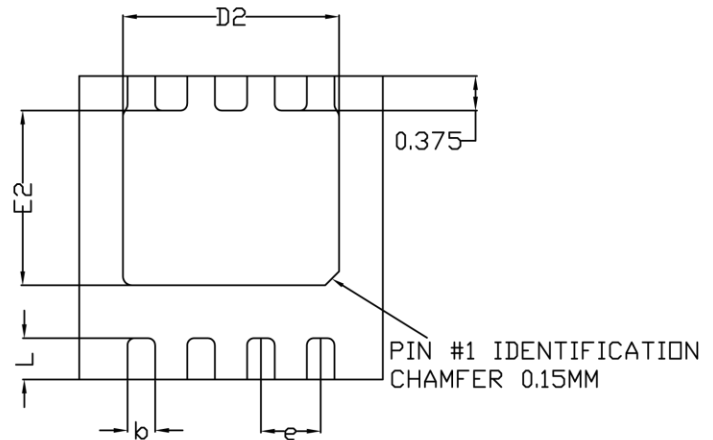

BOTTOM VIEW

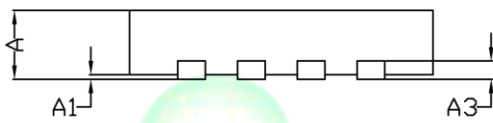

SIDE VIEW

COMMON DIMENSIONS(MM)			
PKG. REF.	UT:ULTRA THIN		
	MIN.	NOM.	MAX
A	0.70	0.75	0.80
A1	0.00	-	0.05
A3	0.20 REF.		
D	3.25	3.30	3.35
E	3.25	3.30	3.35
D2	2.30	2.35	2.40
E2	1.85	1.90	1.95
b	0.25	0.30	0.35
L	0.35	0.45	0.55
e	0.65 BSC		