



## 1.2A USB Power Loading Switch

### General Description

The LPW5208 is an integrated power switch for self-powered and bus-powered Universal Series Bus (USB) applications. A built-in charge pump is used to drive the N-Channel MOSFET that is free of parasitic body diode to eliminate any reversed current flow across the switch when it is powered off. Its low quiescent current (16µA) and small package (SOT23-5) is particularly suitable in battery-powered portable equipment.

Several protection functions include soft start to limit inrush current during plug-in, current limiting at 1500mA to meet USB power requirement, and thermal shutdown to protect damage under over current conditions.

### Features

- ◆ 160mΩ Low  $R_{DS(ON)}$ , High-side N-MOSFET
- ◆ Guaranteed 1200mA Continuous Current
- ◆ 2.5V to 6V Input Voltage
- ◆ Low Quiescent Current: 16µA
- ◆ Soft Start Function
- ◆ Built-In Short-Circuit Protection
- ◆ Built-In Thermal Protection
- ◆ RoHS Compliant and 100% Lead(Pb)-Free

### Typical Application Circuit

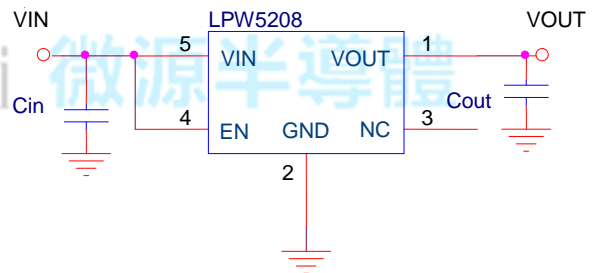

### Order Information

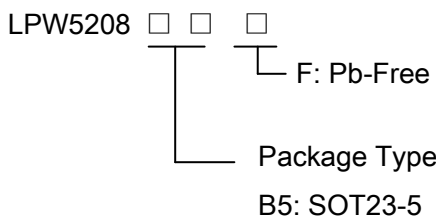

### Applications

- ✧ Power Switch
- ✧ USB Device
- ✧ Battery Charger Circuits

### Marking Information

Device	Marking	Package	Shipping
LPW5208	Please visit our website.	SOT23-5	



### Functional Pin Description

Package Type	Pin Configurations
SOT23-5	<p style="text-align: center;">Top View</p>

### Pin Description

Pin	Name	Description
1	VOUT	Output to system pin.
2	GND	Ground.
3	NC	No connector.
4	EN	Device Enable (active High).
5	VIN	Input pin.

### Function Block Diagram

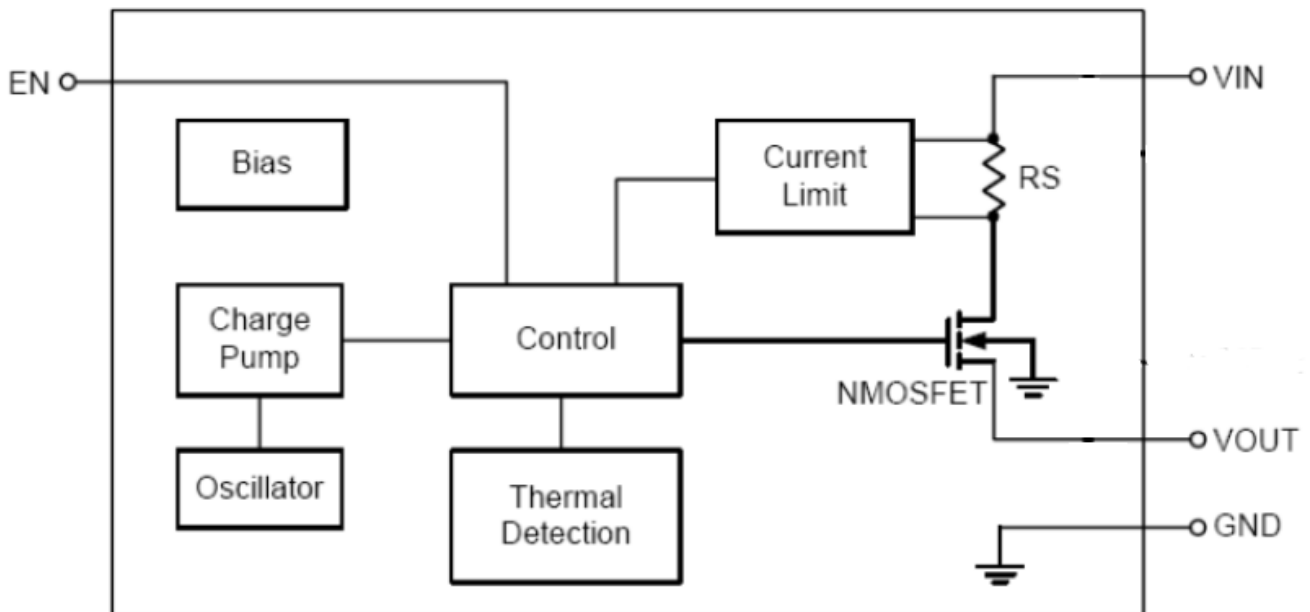



## Absolute Maximum Ratings <sup>Note 1</sup>

- ◇ Input Voltage to GND ----- 6.5V
- ◇ Output Voltage to GND ----- 6.5V
- ◇ Other pin to GND ----- 6V
- ◇ Maximum Junction Temperature ----- 150°C
- ◇ Operating Ambient Temperature Range (T<sub>A</sub>) ----- -40°C to 85°C
- ◇ Maximum Soldering Temperature (at leads, 10 sec) ----- 260°C

**Note 1.** Stresses beyond those listed under “Absolute Maximum Ratings” may cause permanent damage to the device. These are stress ratings only, and functional operation of the device at these or any other conditions beyond those indicated in the operational sections of the specifications is not implied. Exposure to absolute maximum rating conditions for extended periods may affect device reliability.

## Thermal Information

- ◇ Maximum Power Dissipation (P<sub>D</sub>) ----- 0.45W
- ◇ Thermal Resistance (θ<sub>JA</sub>) ----- 250°C/W

## ESD Susceptibility

- ◇ HBM(Human Body Mode) ----- 2KV
- ◇ MM(Machine Mode) ----- 200V

## Electrical Characteristics

(Over recommended operating conditions unless specified otherwise) V<sub>IN</sub>=5.0V, EN=High, T<sub>A</sub>=25°C )

Symbol	Parameter	Condition	Min	Typ	Max	Units
V <sub>IN</sub>	Input Voltage		2.5		6	V
I <sub>LIMIT</sub>	Output Current Limited	R <sub>L</sub> =2Ω	1200	1500	1700	mA
I <sub>OUT</sub>	Output Continue Current				1200	mA
R <sub>DS(ON)</sub>	Output N-MOSFET R <sub>DS(ON)</sub>			160		mΩ
I <sub>Q</sub>	Quiescent Current	V <sub>IN</sub> =3V		16	28	μA
I <sub>SHDN</sub>	Shutdown Current	V <sub>EN</sub> =GND			1	μA
V <sub>EN(L)</sub>	Enable Threshold Low				0.4	V
V <sub>EN(H)</sub>	Enable Threshold High		1.4			V
I <sub>EN</sub>	Input High Current	V <sub>IN</sub> =V <sub>EN</sub> =5.0V		5		μA



### Typical Operating Characteristics

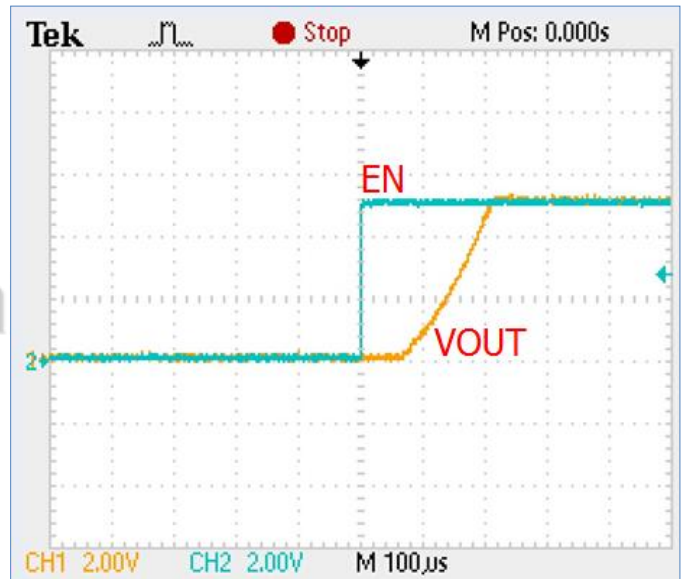
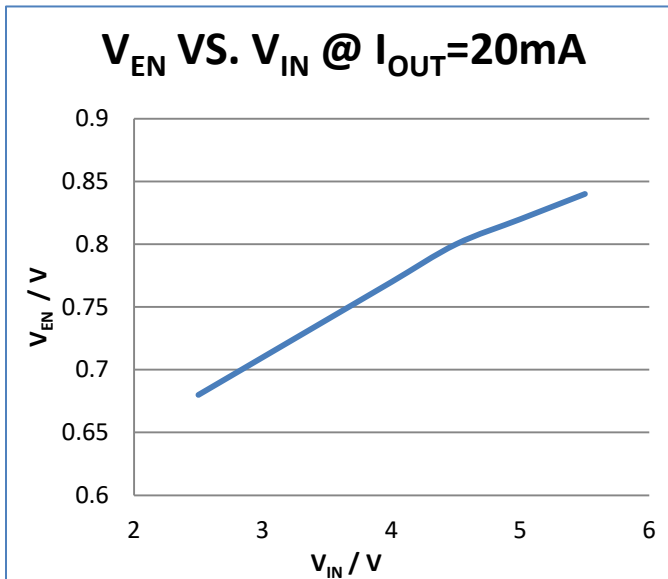
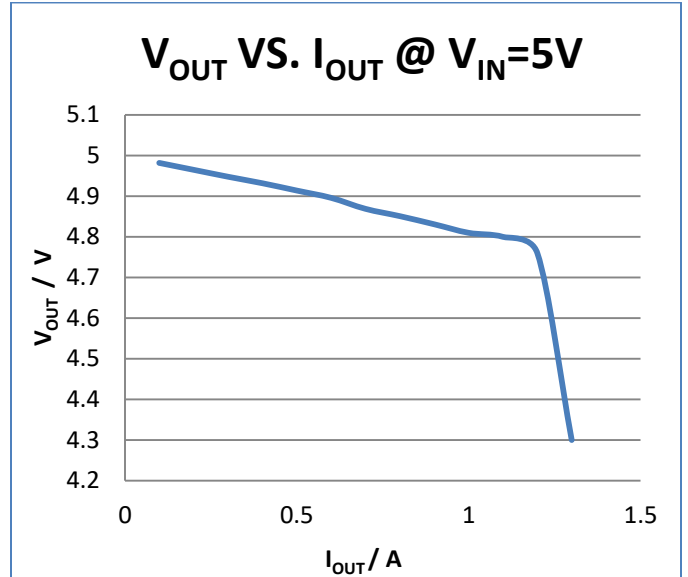
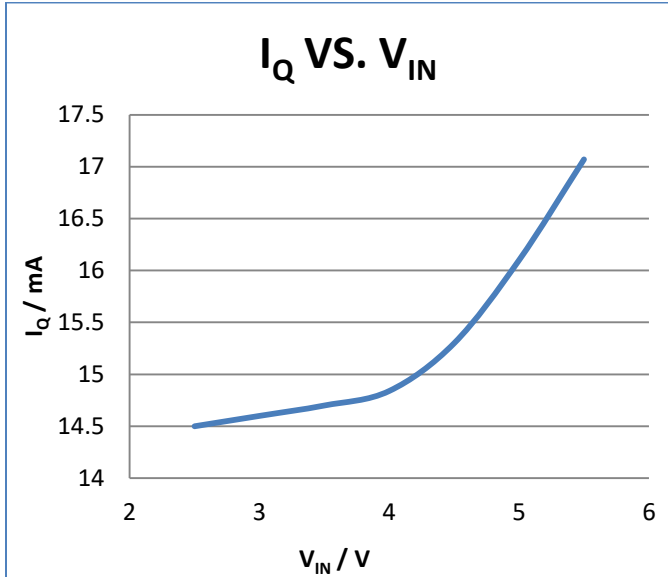



Packaging Information

SOT23-5

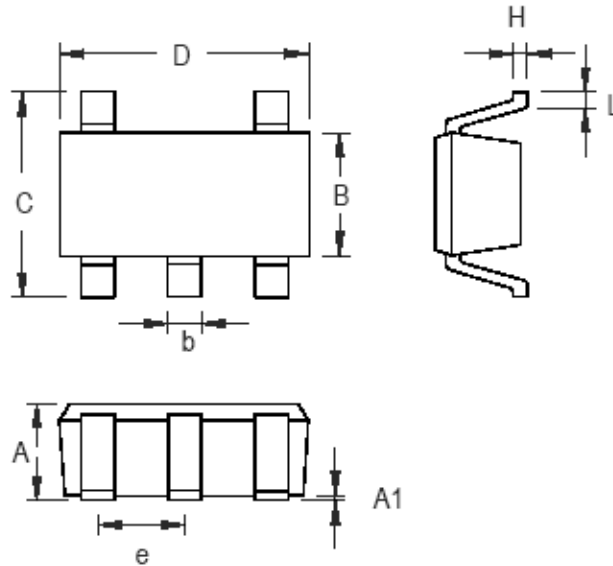

Symbol	Dimensions In Millimeters		Dimensions In Inches	
	Min	Max	Min	Max
A	0.889	1.295	0.035	0.051
A1	0.000	0.152	0.000	0.006
B	1.397	1.803	0.055	0.071
b	0.356	0.559	0.014	0.022
C	2.591	2.997	0.102	0.118
D	2.692	3.099	0.106	0.122
e	0.838	1.041	0.033	0.041
H	0.080	0.254	0.003	0.010
L	0.300	0.610	0.012	0.024

SOT-23-5 Surface Mount Package