

4N60(F,B,H,G,D)

4 Amps,600 Volts N-CHANNEL MOSFET

FEATURE

- 4A,600V, $R_{DS(ON)}=2\Omega$ @ $V_{GS}=10V/2A$
- Low gate charge
- Low C_{iss}
- Fast switching
- 100% avalanche tested
- Improved dv/dt capability

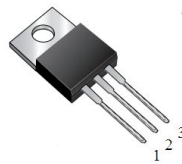
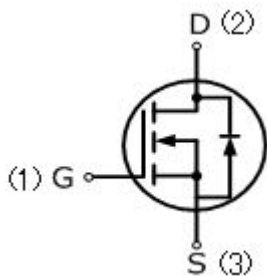

TO-220AB
4N60

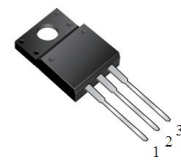

ITO-220AB
4N60F



TO-262
4N60H

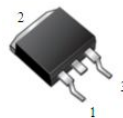

TO-263
4N60B



TO-252
4N60G



TO-251
4N60D

Absolute Maximum Ratings($T_C=25^\circ\text{C}$, unless otherwise noted)

Parameter	Symbol	4N60	UNIT
Drain-Source Voltage	V_{DSS}	600	V
Gate-Source Voltage	V_{GSS}	± 30	
Continuous Drain Current	I_D	4	A
Pulsed Drain Current(Note1)	I_{DM}	16	
Single Pulse Avalanche Energy (Note 2)	E_{AS}	300	mJ
Avalanche Current(Note1)	I_{AR}	4	A
Repetitive Avalanche Energy (Note1)	E_{AR}	30	mJ
Reverse Diode dV/dt (Note 3)	dV/dt	4.5	V/ns
Operating Junction and Storage Temperature Range	T_J, T_{STG}	-55 to +150	$^\circ\text{C}$
Maximum lead temperature for soldering purposes, 1/8" from case for 5 seconds	T_L	260	$^\circ\text{C}$
Mounting Torque	6-32 or M3 screw	10	lbf • in
		1.1	N • m

Thermal Characteristics

Parameter	Symbol	ITO-220	TO-220	TO-262 TO-263	TO-251 TO-252	Units
Maximum Junction-to-Case	R_{thJC}	2.2	1.8	1.8	5.7	$^\circ\text{C}/\text{W}$
Maximum Power Dissipation	P_D	57	70	70	22	W

Electrical Characteristics ($T_c=25^\circ\text{C}$, unless otherwise noted)						
Parameter	Symbol	Test Conditions	Min	Typ	Max	Units
Off Characteristics						
Drain-Source Breakdown Voltage	BV_{DSS}	$V_{GS}=0V, I_D=250\mu A$	600	—	—	V
Breakdown Temperature Coefficient	$\Delta BV_{DSS} / \Delta T_J$	Reference to 25°C , $I_D=250\mu A$	—	0.6	—	$V/^\circ\text{C}$
Zero Gate Voltage Drain Current	I_{DSS}	$V_{DS}=600V, V_{GS}=0V$	—	—	1	μA
Gate-Body Leakage Current, Forward	I_{GSSF}	$V_{GS}=30V, V_{DS}=0V$	—	—	10	μA
Gate-Body Leakage Current, Reverse	I_{GSSR}	$V_{GS}=-30V, V_{DS}=0V$	—	—	-10	μA
On Characteristics						
Gate-Source Threshold Voltage	$V_{GS(th)}$	$V_{DS}=V_{GS}, I_D=250\mu A$	2	—	4	V
Drain-Source On-State Resistance	$R_{DS(on)}$	$V_{GS}=10V, I_D=2A$	—	—	2.5	Ω
Dynamic Characteristics						
Input Capacitance	C_{iss}	$V_{DS}=25V, V_{GS}=0V,$ $f=1.0\text{MHZ}$	—	520	670	pF
Output Capacitance	C_{oss}		—	70	90	pF
Reverse Transfer Capacitance	C_{rss}		—	8	11	pF
Switching Characteristics						
Turn-On Delay Time	$t_{d(on)}$	$V_{DD}=300V, I_D=4A,$ $R_G=25\Omega$ (Note4,5)	—	13	2835	ns
Turn-On Rise Time	t_r		—	45	400	ns
Turn-Off Delay Time	$t_{d(off)}$		—	25	60	ns
Turn-Off Fall Time	t_f		—	35	80	ns
Total Gate Charge	Q_g	$V_{DS}=480V, I_D=4A,$ $V_{GS}=10V,$ (Note4,5)	—	15	20	nC
Gate-Source Charge	Q_{gs}		—	3.4	—	nC
Gate-Drain Charge	Q_{gd}		—	7.1	—	nC
Drain-Source Body Diode Characteristics and Maximum Ratings						
Continuous Diode Forward Current	I_S		—	—	4	A
Pulsed Diode Forward Current	I_{SM}		—	—	16	A
Diode Forward Voltage	V_{SD}	$I_S=4A, V_{GS}=0V$	—	—	1.5	V
Reverse Recovery Time	t_{rr}	$V_{GS}=0V, I_S=4A,$ $di_f/dt=100A/\mu s,$ (Note4)	—	250	—	ns
Reverse Recovery Charge	Q_{rr}		—	1.5	—	μC

Notes

1. Repetitive Rating: pulse width limited by maximum junction temperature.
2. $V_{DD}=50V, L=36mH, R_g=25\Omega, I_{AS}=4A$, starting $T_J=25^\circ\text{C}$.
3. $I_{SD} \leq I_D, di/dt=200A/\mu s, V_{DD} \leq BV_{DSS}$, starting $T_J=25^\circ\text{C}$.
4. Pulse width $\leq 300\mu s$; duty cycle $\leq 2\%$.
5. Repetitive rating; pulse width limited by maximum junction temperature.

TEST CIRCUIT AND WAVEFORM

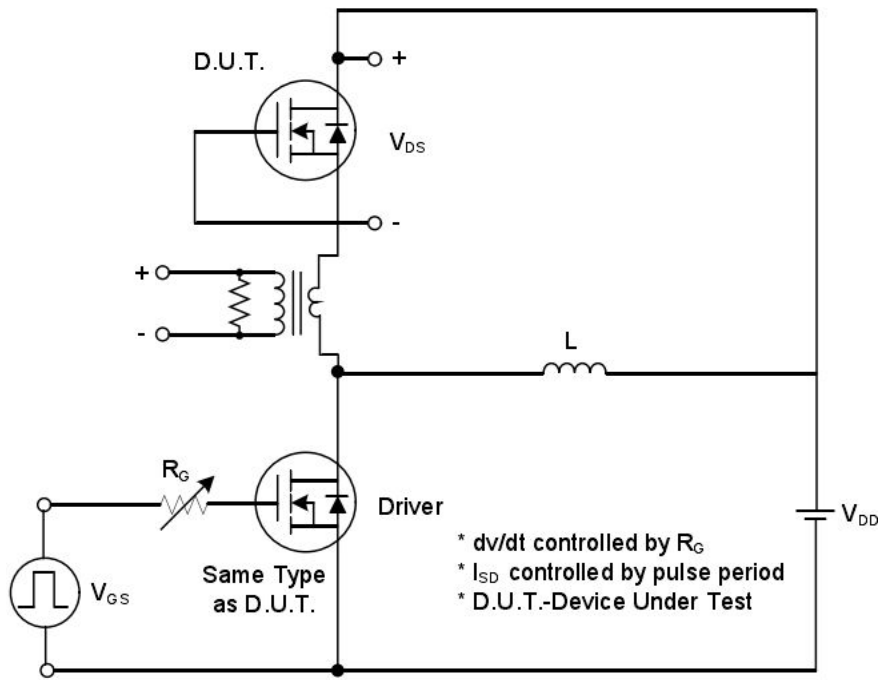

Peak Diode Recovery dv/dt Test Circuit

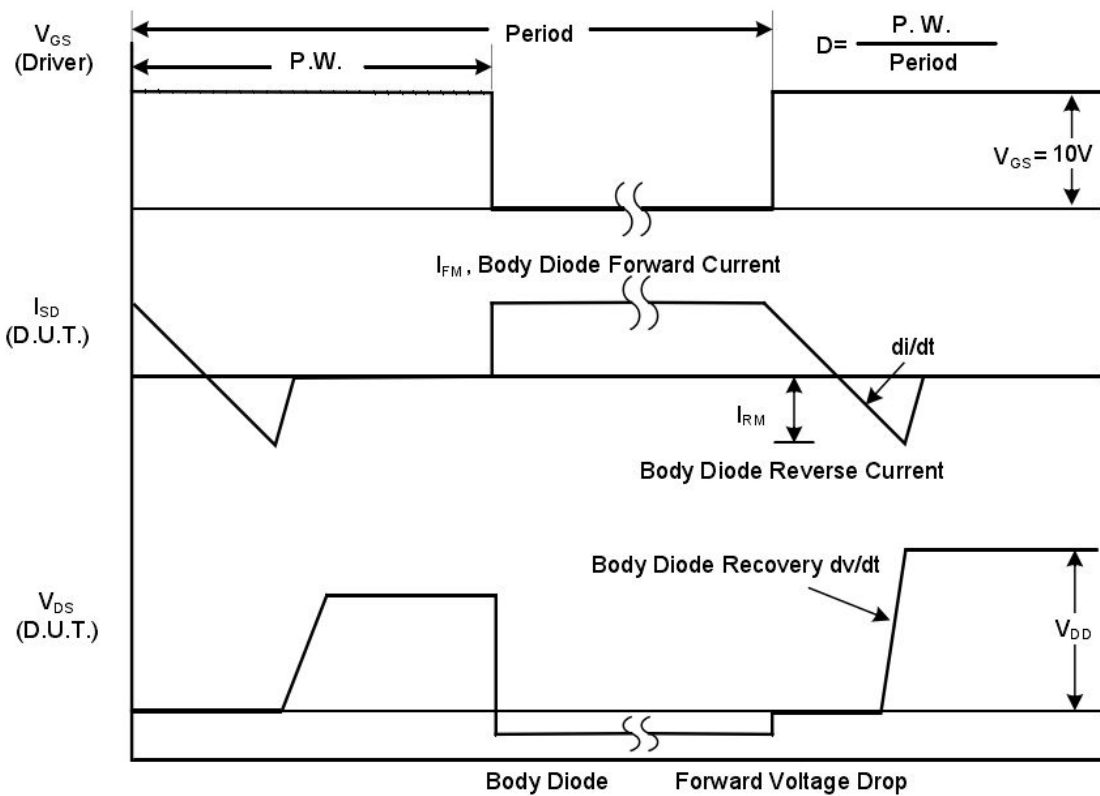

Peak Diode Recovery dv/dt Waveforms

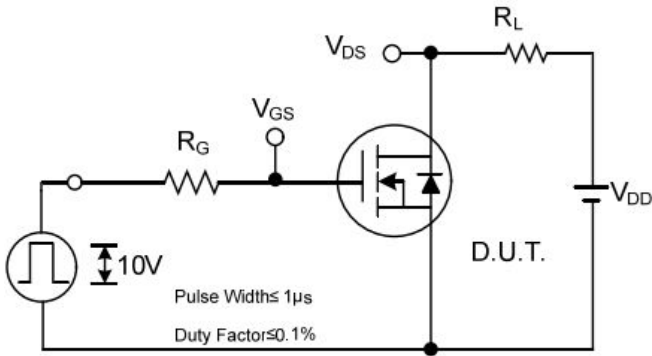

Switching Test Circuit

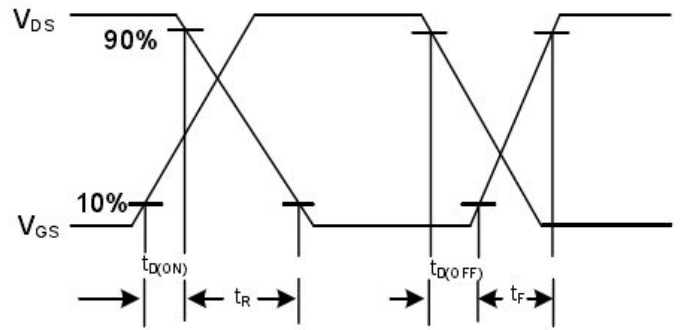

Switching Waveforms

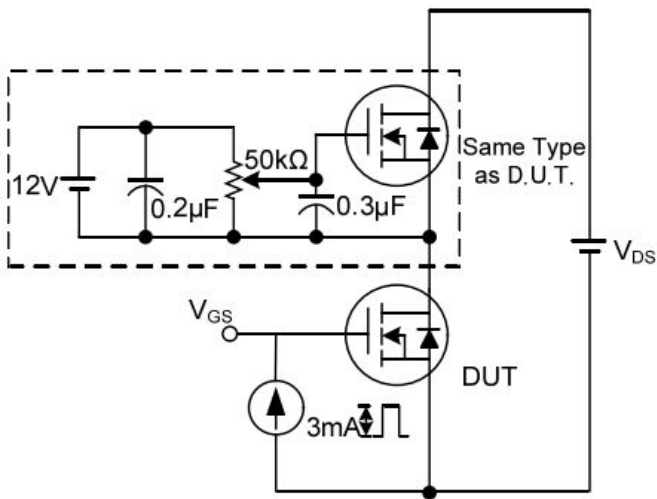

Gate Charge Test Circuit

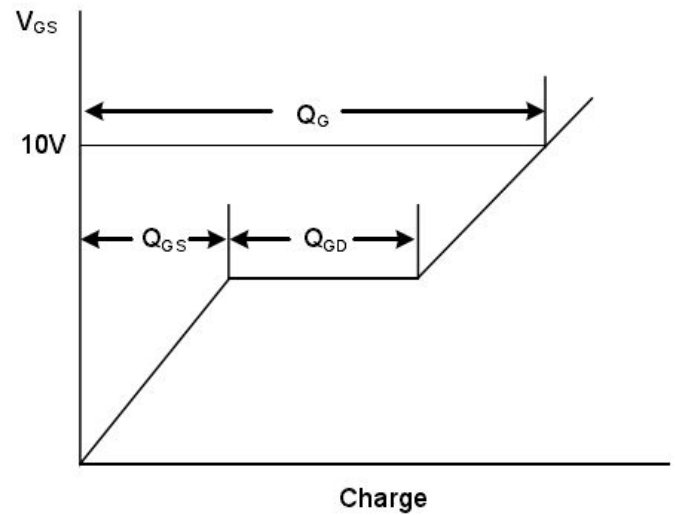

Gate Charge Waveform

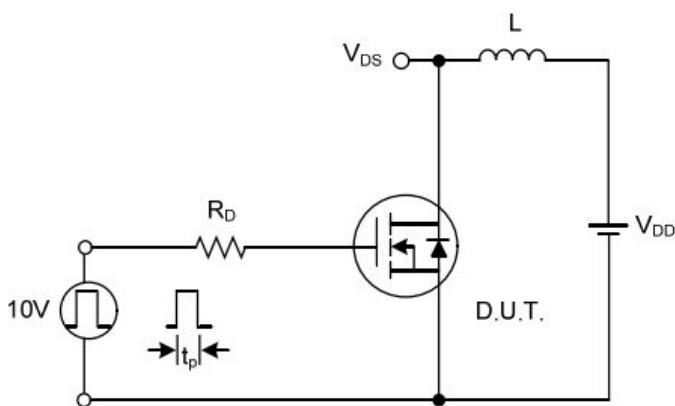

Unclamped Inductive Switching Test Circuit

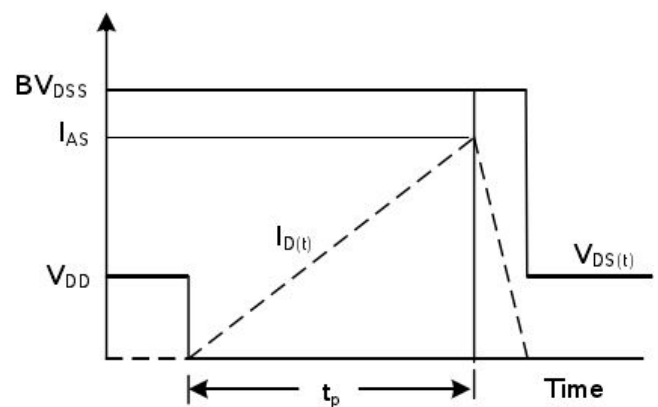

Unclamped Inductive Switching Waveforms

RATING AND CHARACTERISTIC CURVES

Breakdown Voltage Variation vs. Temperature

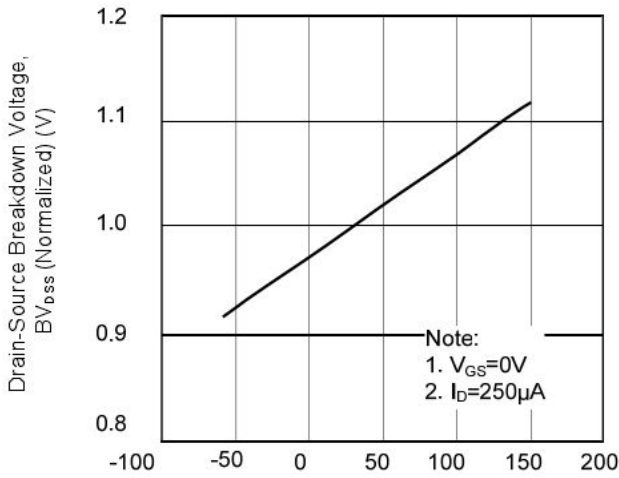

Safe Operating Area - 600V

On-Resistance Junction Temperature

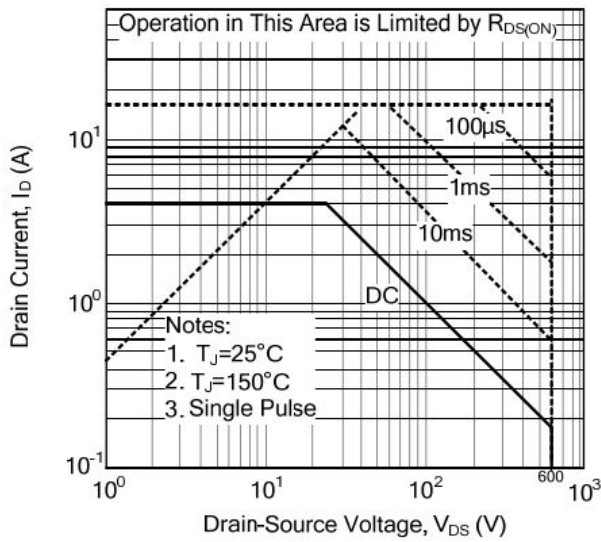
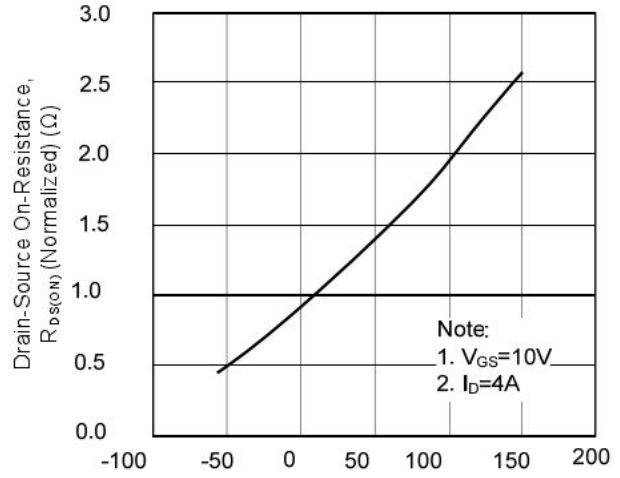

On-State Characteristics

Maximum Drain Current vs. Case Temperature

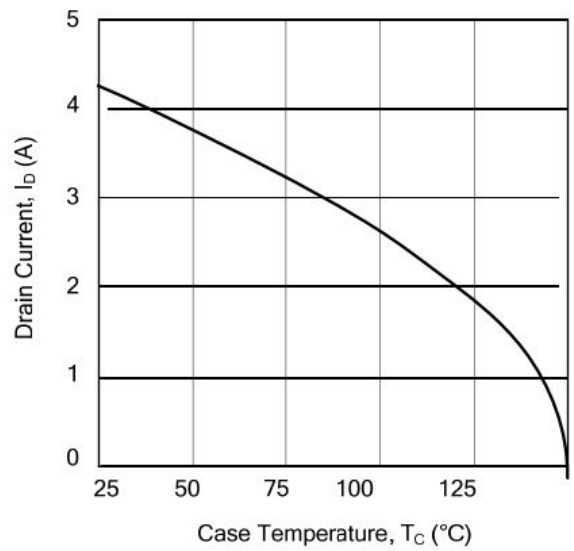

Transfer Characteristics

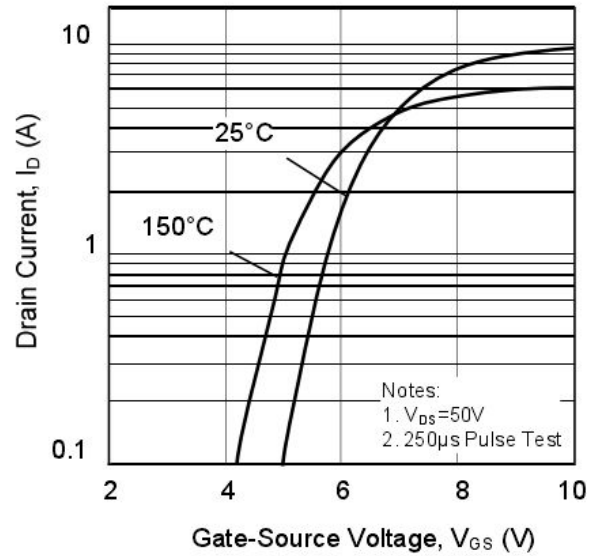
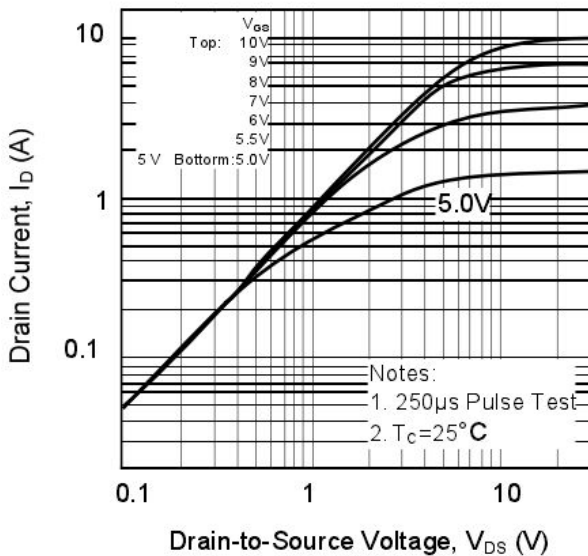

On-Resistance Variation vs. Drain Current and Gate Voltage

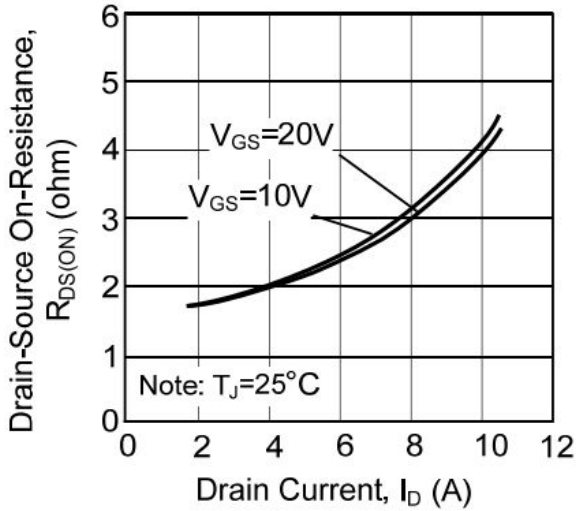

On State Current vs. Allowable Case Temperature

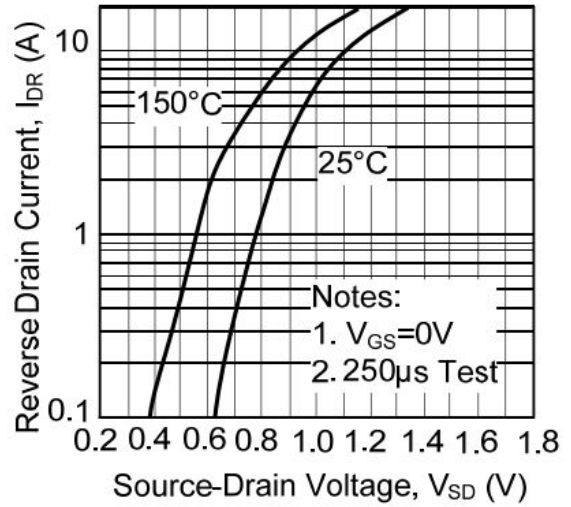

Capacitance Characteristics (Non-Repetitive)

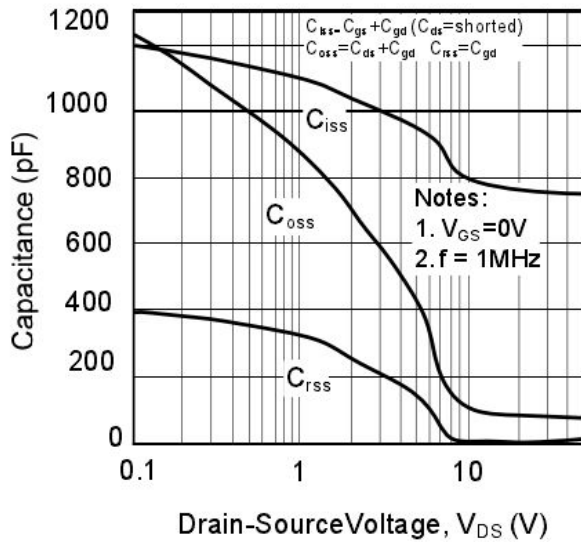

Gate Charge Characteristics

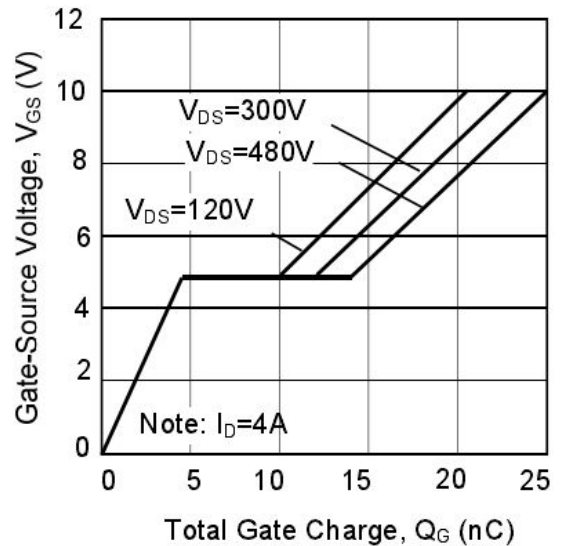

Transient Thermal Response Curve

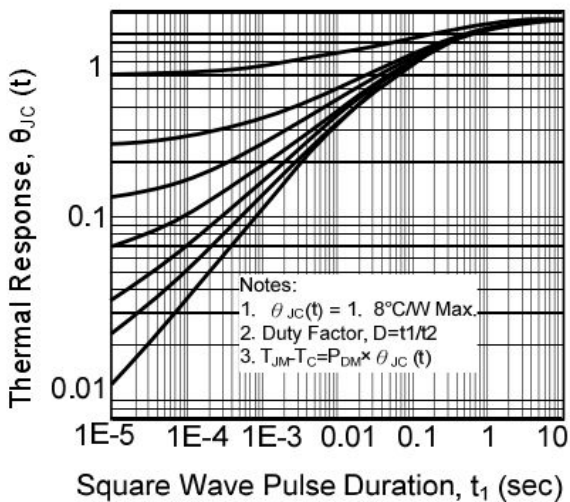

Power Dissipation

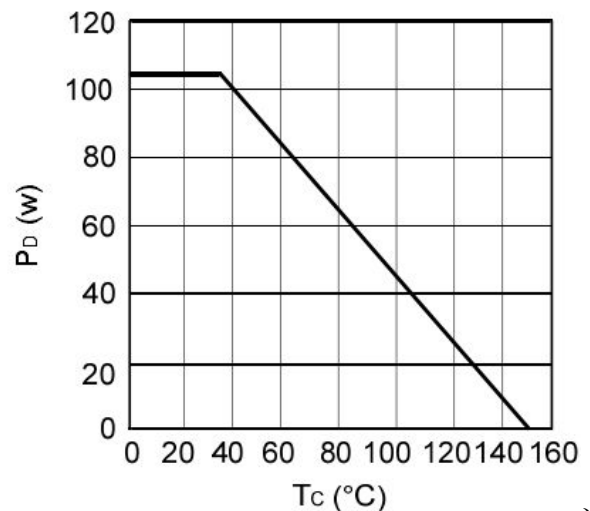

PACKAGE OUTLINE DIMENSIONS

TO-220AB

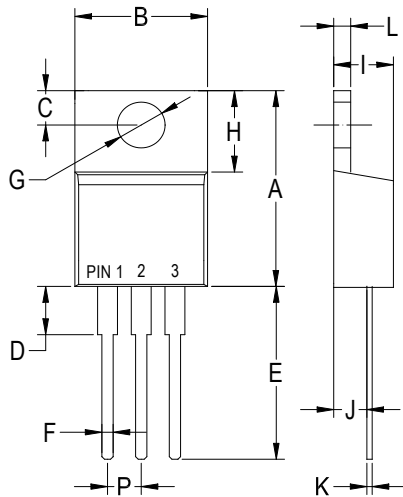

TO-220AB		
Dim	Min	Max
A	.573 (14.55)	.603 (15.32)
B	—	.412 (10.5)
C	.103 (2.62)	.113 (2.87)
D	.140 (3.56)	.160 (4.06)
E	.510 (13.0)	.560 (14.3)
F	.027 (0.68)	.037 (0.94)
G	.148 (3.74)	.154 (3.91)
H	.230 (5.84)	.270 (6.86)
I	.175 (4.44)	.185 (4.86)
J	.100 (2.54)	.110 (2.79)
K	.014 (0.35)	.025 (0.64)
L	.045 (1.14)	.055 (1.40)
P	.095 (2.41)	.105 (2.67)

ITO-220AB

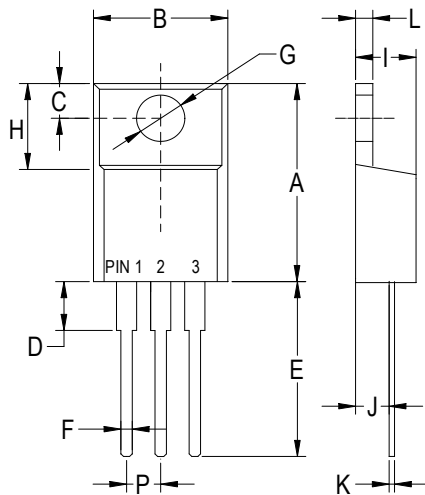

ITO-220AB		
Dim	Min	Max
A	.571 (14.5)	.610 (15.5)
B	.383 (9.72)	.406 (10.3)
C	.110 (2.80)	.126 (3.20)
D	.133 (3.38)	.162 (4.10)
E	.512 (13.0)	.551 (14.0)
F	.028 (0.70)	.035 (0.90)
G	.114 (2.90)	.138 (3.50)
H	.268 (6.80)	.291 (7.40)
I	.162 (4.10)	.185 (4.70)
J	.102 (2.60)	.110 (2.80)
K	.018 (0.45)	.026 (0.65)
L	.097 (2.46)	.113 (2.86)
P	.890 (2.25)	.113 (2.85)

TO-251

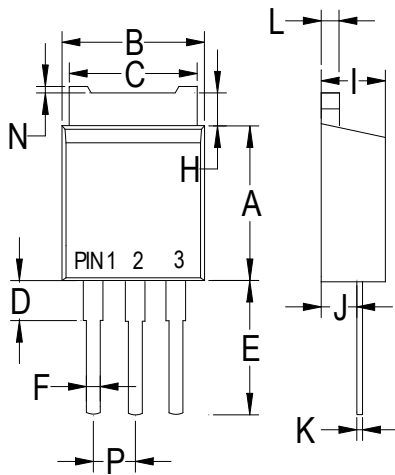

TO-251		
Dim	Min	Max
A	.230 (5.85)	.246 (6.25)
B	.250 (6.35)	.266 (6.75)
C	.207 (5.27)	.218 (5.54)
D	.037 (0.93)	.045 (1.14)
E	.173 (4.40)	.205 (5.20)
F	.028 (0.72)	.033 (0.84)
H	.028 (0.70)	.043 (1.10)
I	.085 (2.15)	.096 (2.45)
J	.037 (0.95)	.047 (1.20)
K	.018 (0.45)	.026 (0.65)
L	.018 (0.45)	.024 (0.60)
N	---	.008 (0.20)
P	.081 (2.05)	.094 (2.40)

TO-252

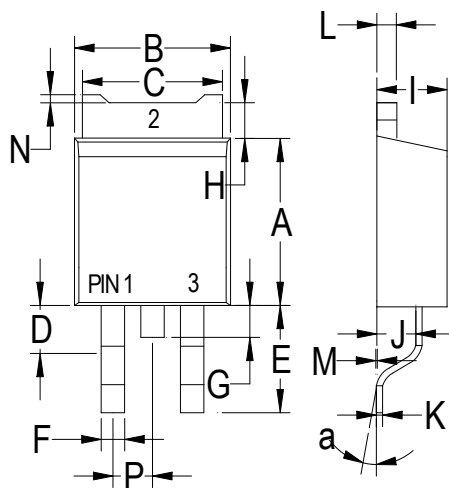

TO-252		
Dim	Min	Max
A	.230 (5.85)	.246 (6.25)
B	.250 (6.35)	.264 (6.75)
C	.207 (5.27)	.218 (5.54)
D	.037 (0.93)	.045 (1.14)
E	.106 (2.70)	.138 (3.50)
F	.028 (0.72)	.033 (0.84)
G	.024 (0.60)	.041 (1.05)
H	.028 (0.72)	.043 (1.10)
I	.085 (2.15)	.096 (2.45)
J	.037 (0.95)	.047 (1.20)
K	.018 (0.45)	.026 (0.65)
L	.018 (0.45)	.024 (0.60)
P	.081 (2.05)	.094 (2.40)
M	.000 (0.00)	.006 (0.15)
N	---	.008 (0.20)
a	0°	10°

TO-262

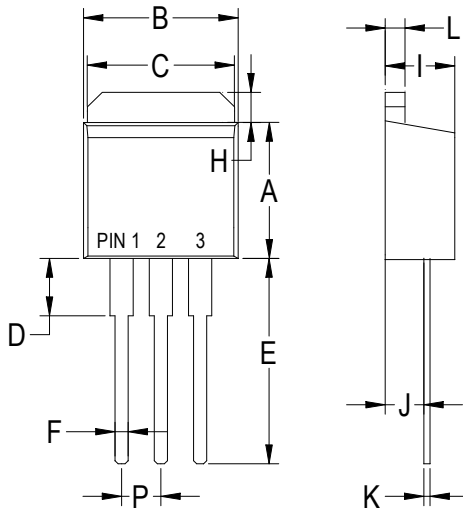

TO-262		
Dim	Min	Max
A	.323 (8.20)	.348 (8.85)
B	.394 (10.0)	.413 (10.5)
C	.394 (10.0)	.402 (10.2)
D	.140 (3.56)	.160 (4.06)
E	.510 (13.0)	.560 (14.3)
F	.027 (0.68)	.037 (0.94)
H	.046 (1.17)	.053 (1.34)
I	.175 (4.44)	.185 (4.86)
J	.100 (2.54)	.110 (2.79)
K	.014 (0.35)	.025 (0.64)
L	.045 (1.14)	.055 (1.40)
P	.095 (2.41)	.105 (2.67)

TO-263

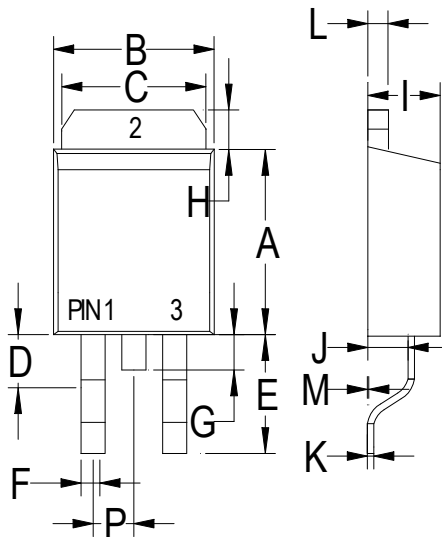

TO-263		
Dim	Min	Max
A	.323 (8.20)	.348 (8.85)
B	.394 (10.0)	.413 (10.5)
C	.394 (10.0)	.402 (10.2)
D	.077 (1.95)	.100 (2.55)
E	.204 (5.17)	.227 (5.77)
F	.027 (0.68)	.037 (0.94)
G	--	.067 (1.70)
H	.046 (1.17)	.053 (1.34)
I	.175 (4.44)	.191 (4.86)
J	.100 (2.54)	.110 (2.79)
K	.014 (0.35)	.025 (0.64)
L	.047 (1.20)	.055 (1.40)
M	.000 (0.00)	.010 (0.25)
P	.095 (2.41)	.105 (2.67)