

10N50TF

10 Amps,500 Volts N-CHANNEL Power MOSFET

FEATURE

- 10A,500V, $R_{DS(ON)MAX}=0.75\ \Omega$ @ $V_{GS}=10V/5A$
- Low gate charge
- Low C_{iss}
- Fast switching
- 100% avalanche tested
- Improved dv/dt capability
- Halogen free

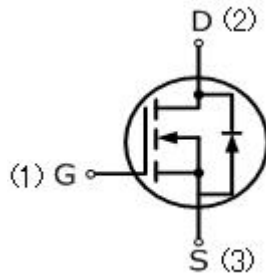

TO-220TF

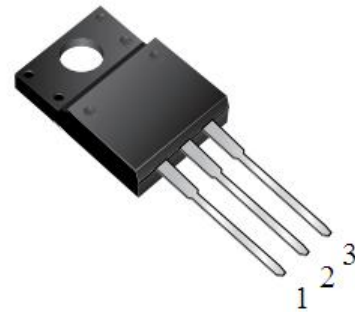

Absolute Maximum Ratings ($T_C=25^\circ\text{C}$, unless otherwise noted)

Parameter	Symbol	10N50TF	UNIT
Drain-Source Voltage	V_{DSS}	500	V
Gate-Source Voltage	V_{GSS}	± 30	
Continuous Drain Current	I_D	10	A
Pulsed Drain Current(Note1)	I_{DM}	40	
Single Pulse Avalanche Energy (Note 2)	E_{AS}	580	mJ
Reverse Diode dV/dt (Note 3)	dv/dt	5	V/ns
Operating Junction and Storage Temperature Range	T_J, T_{STG}	-55to+150	$^\circ\text{C}$
Maximum lead temperature for soldering purposes, 1/8" from case for 5 seconds	T_L	260	$^\circ\text{C}$
Mounting Torque	6-32 or M3 screw	10	lbf • in
		1.1	N • m

Parameter	Symbol	10N50TF	Units
Thermal resistance , Channel to Case	$R_{th(ch-c)}$	3.13	$^\circ\text{C}/\text{W}$
Thermal resistance , Channel to Ambient	$R_{th(ch-a)}$	62.5	$^\circ\text{C}/\text{W}$
Maximum Power Dissipation	$T_C=25^\circ\text{C}$ P_D	40	W

Electrical Characteristics (T_c=25°C, unless otherwise noted)						
Parameter	Symbol	Test Conditions	Min	Typ	Max	Units
Off Characteristics						
Drain-Source Breakdown Voltage	BV _{DSS}	V _{GS} =0V, I _D =250uA	500	—	—	V
Breakdown Temperature Coefficient	ΔBV _{DSS} /ΔT _J	Reference to 25°C , I _D =250uA	—	0.6	—	V/°C
Zero Gate Voltage Drain Current	I _{DSS}	V _{DS} =500V, V _{GS} =0V	—	—	1	uA
Gate-Body Leakage Current, Forward	I _{GSSF}	V _{GS} =30V, V _{DS} =0V	—	—	100	nA
Gate-Body Leakage Current, Reverse	I _{GSSR}	V _{GS} =-30V, V _{DS} =0V	—	—	-100	nA
On Characteristics						
Gate-Source Threshold Voltage	V _{GS(th)}	V _{DS} =V _{GS} , I _D =250uA	2	—	4	V
Drain-Source On-State Resistance	R _{DS(on)}	V _{GS} =10V, I _D =5A	—	0.5	0.75	Ω
Dynamic Characteristics						
Input Capacitance	C _{iss}	V _{DS} =25V, V _{GS} =0V, f=1.0MHZ	—	1620	—	pF
Output Capacitance	C _{oss}		—	154	—	pF
Reverse Transfer Capacitance	C _{rss}		—	8.4	—	pF
Switching Characteristics						
Turn-On Delay Time	t _{d(on)}	V _{DD} =250V, I _D =10A, R _G =10Ω (Note3,4)	—	26	—	ns
Turn-On Rise Time	t _r		—	20	—	ns
Turn-Off Delay Time	t _{d(off)}		—	52	—	ns
Turn-Off Fall Time	t _f		—	21	—	ns
Total Gate Charge	Q _g	V _{DS} =400V, I _D =10A, V _{GS} =10V, (Note3,4)	—	32	—	nC
Gate-Source Charge	Q _{gs}		—	7.9	—	nC
Gate-Drain Charge	Q _{gd}		—	12	—	nC
Drain-Source Body Diode Characteristics and Maximum Ratings						
Continuous Diode Forward Current	I _S		—	—	10	A
Pulsed Diode Forward Current	I _{SM}		—	—	40	A
Diode Forward Voltage	V _{SD}	I _S =10A, V _{GS} =0V	—	—	1.5	V
Reverse Recovery Time	t _{rr}	V _{GS} =0V, I _S =10A, dI _F /dt=100A/us, (Note4)	—	411	—	ns
Reverse Recovery Charge	Q _{rr}		—	2.588	—	uC

Notes

1. Repetitive Rating: pulse width limited by maximum junction temperature.
2. L=10mH, I_{AS}=10.8A, starting T_J=25°C.
3. I_{SD}=10A, dI/dt ≤ 100A/us, V_{DD} ≤ BV_{DSS}, starting T_J=25°C, Pulse width ≤ 300us; duty cycle ≤ 2%.
4. Repetitive rating; pulse width limited by maximum junction temperature.

TEST CIRCUIT AND WAVEFORM

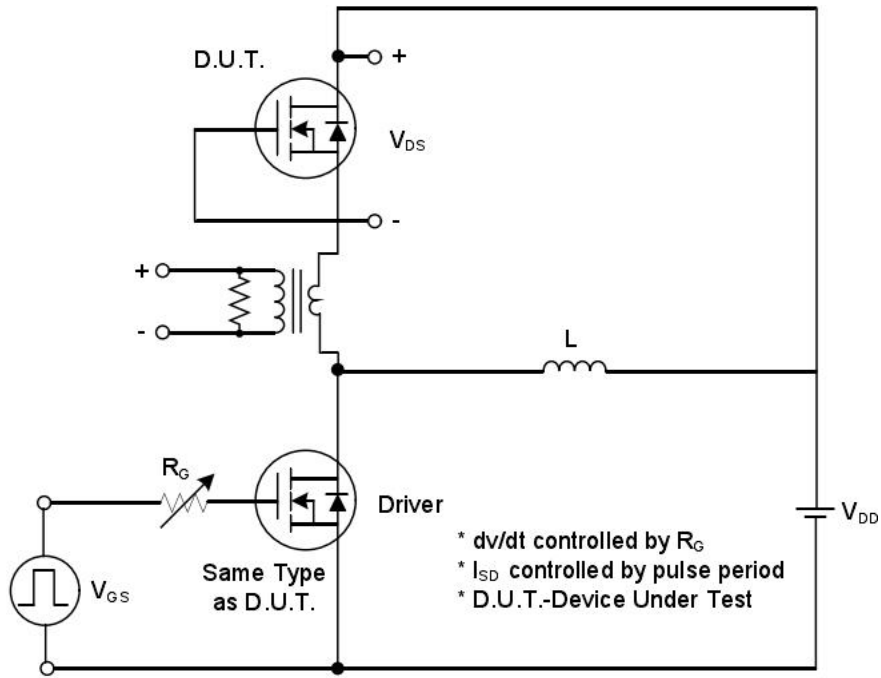

Peak Diode Recovery dv/dt Test Circuit

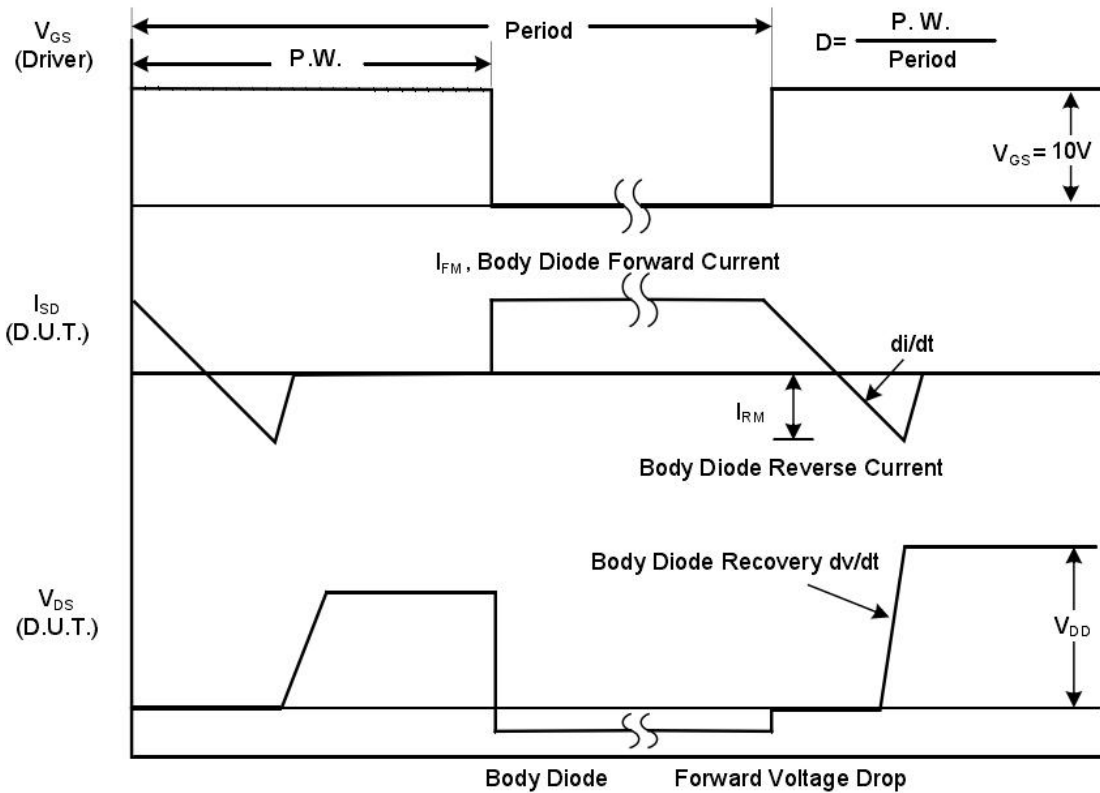

Peak Diode Recovery dv/dt Waveforms



Switching Test Circuit

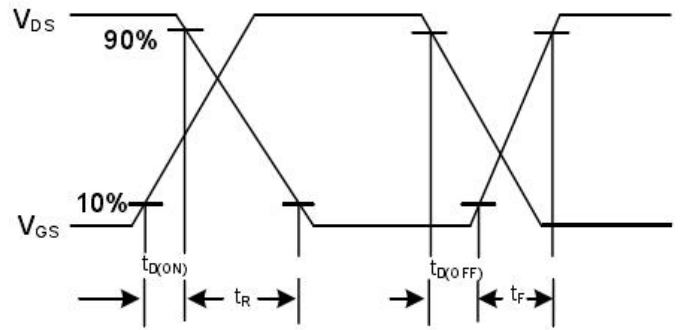

Switching Waveforms

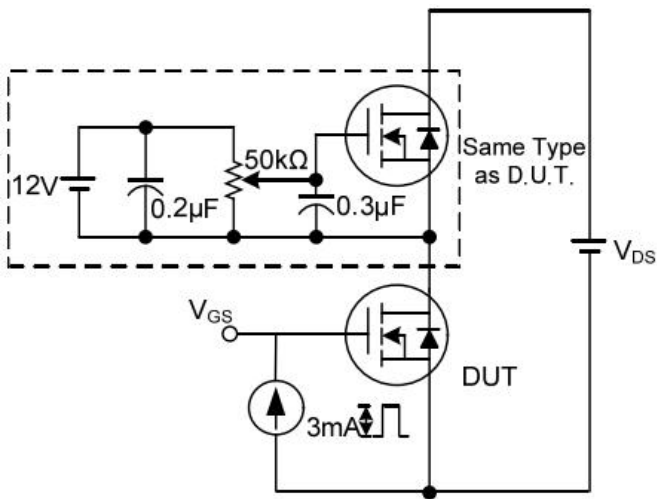

Gate Charge Test Circuit

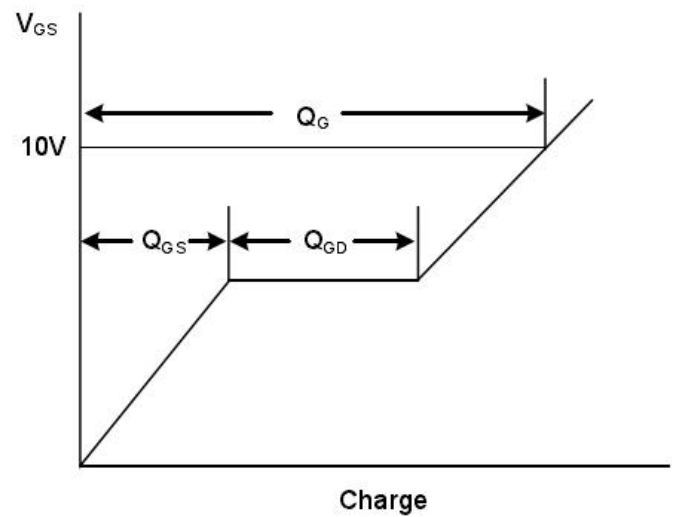

Gate Charge Waveform

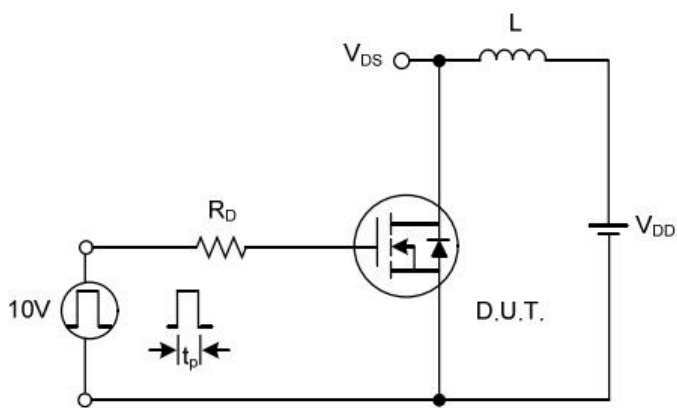

Unclamped Inductive Switching Test Circuit

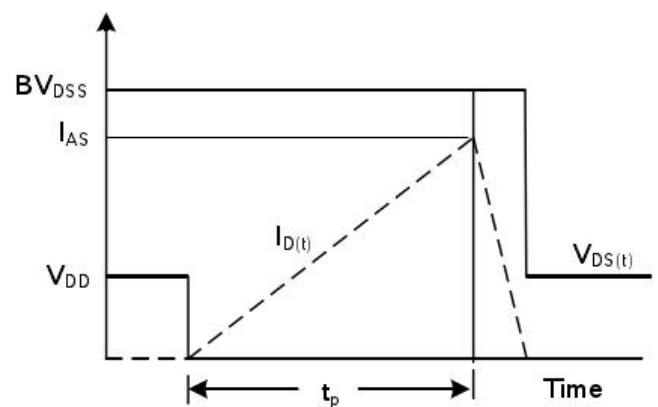

Unclamped Inductive Switching Waveforms

RATING AND CHARACTERISTIC CURVES

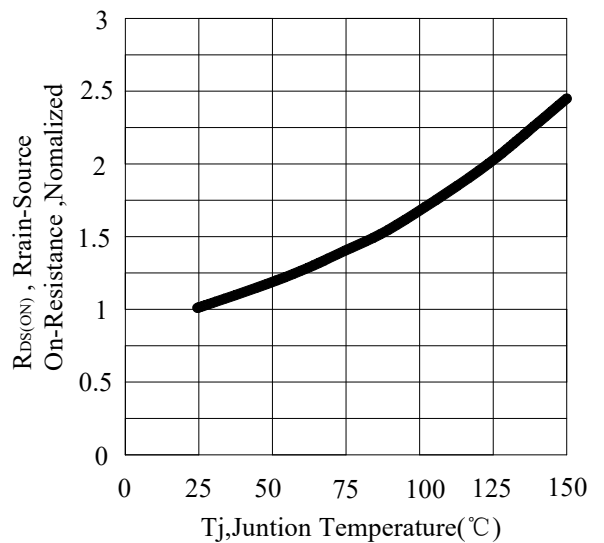
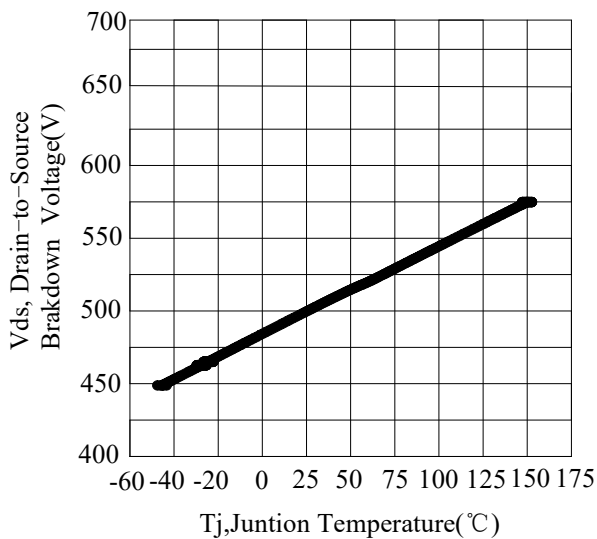
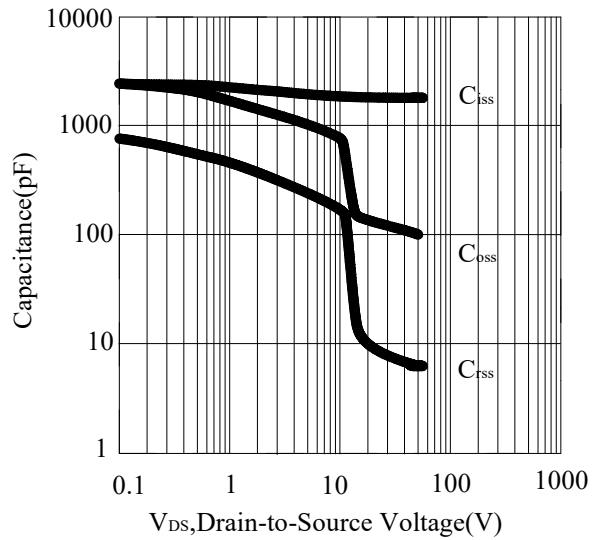
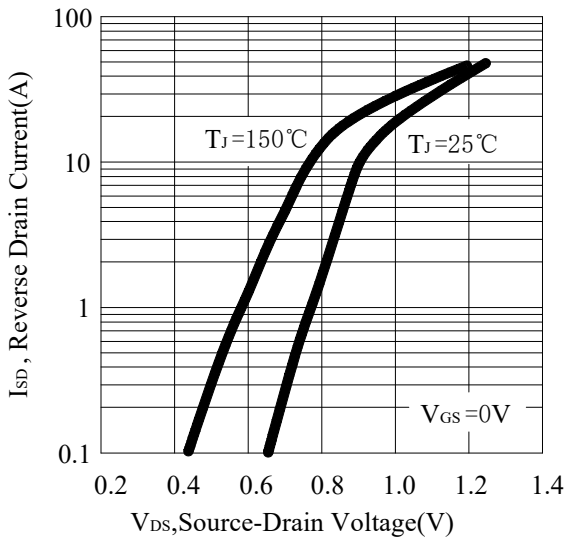
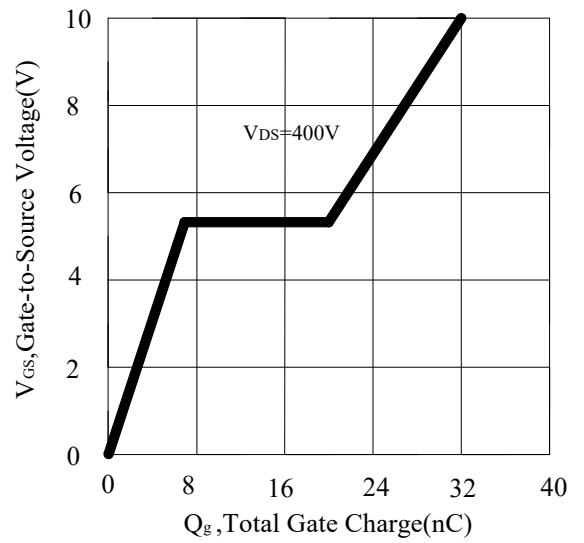
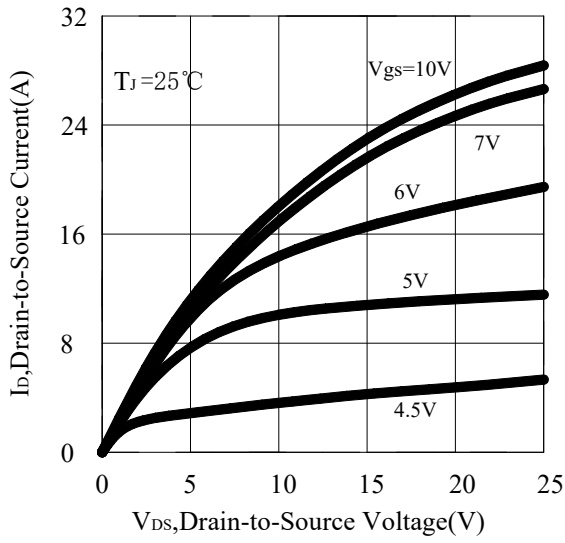

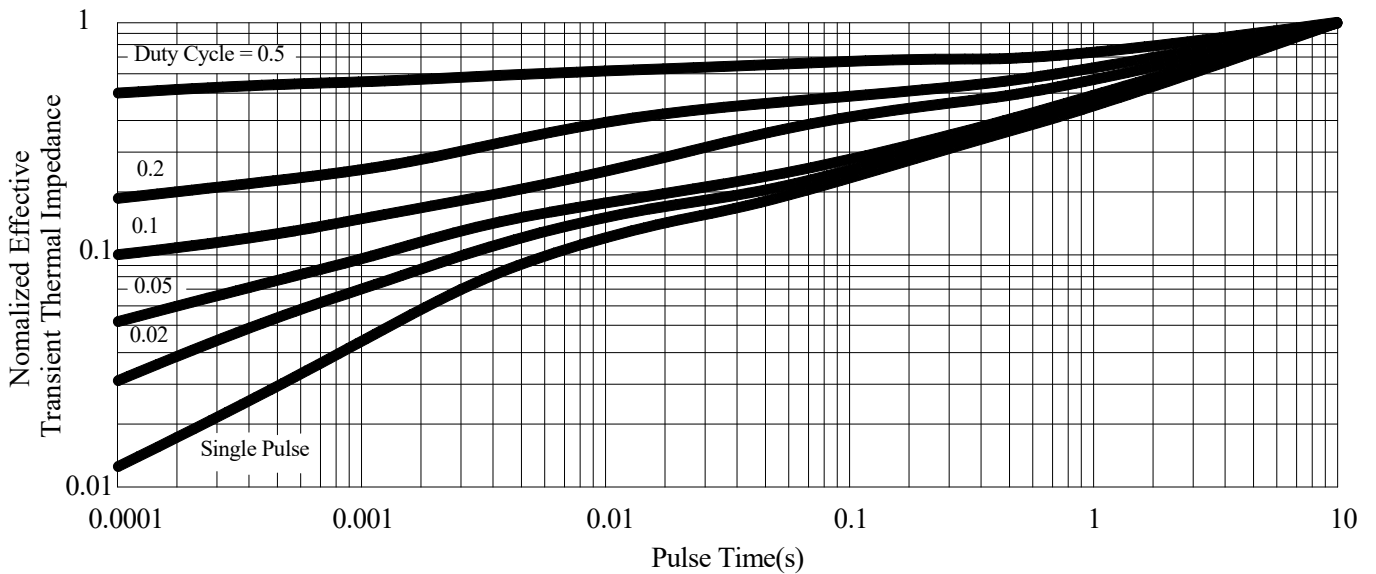
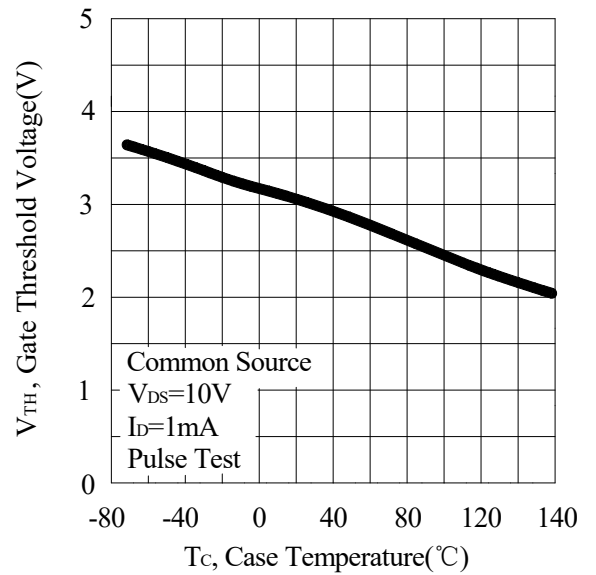
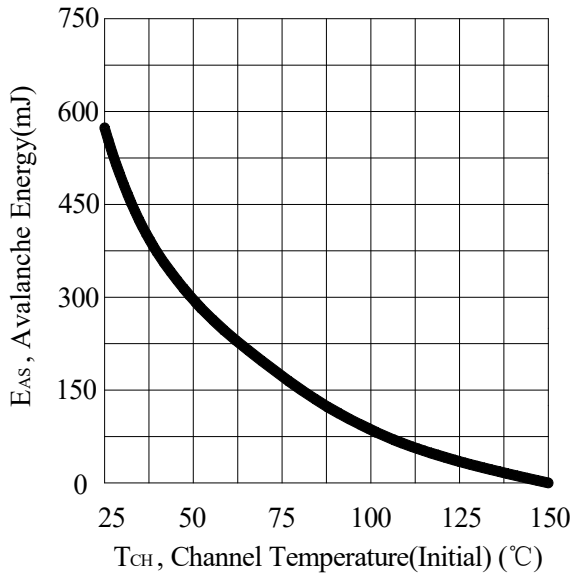
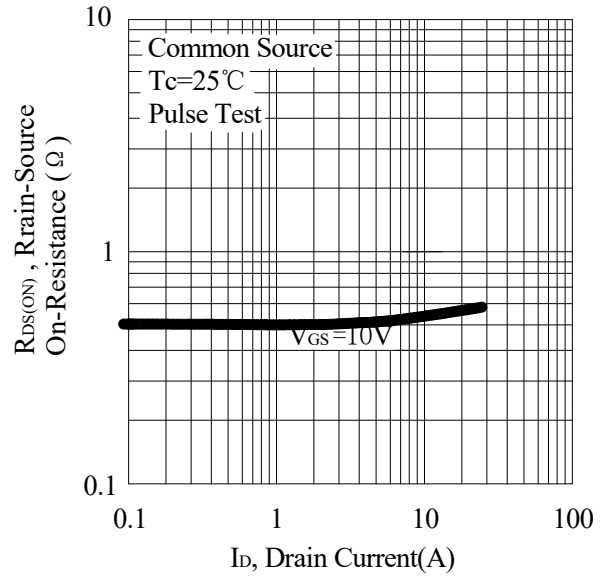
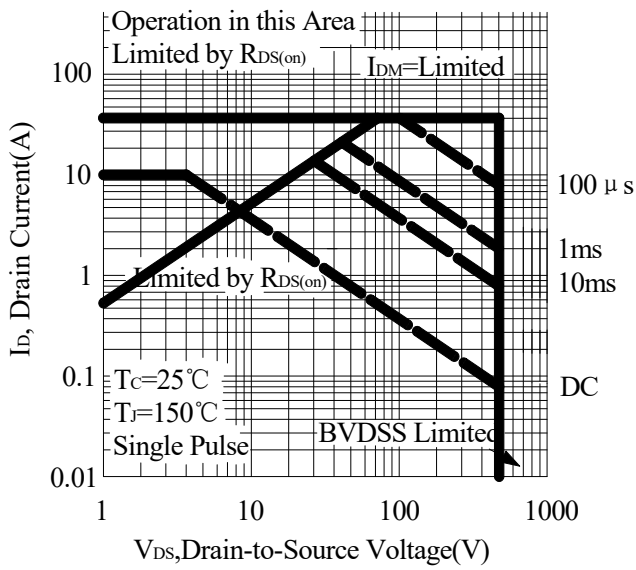

PACKAGE OUTLINE DIMENSIONS

TO-220TF

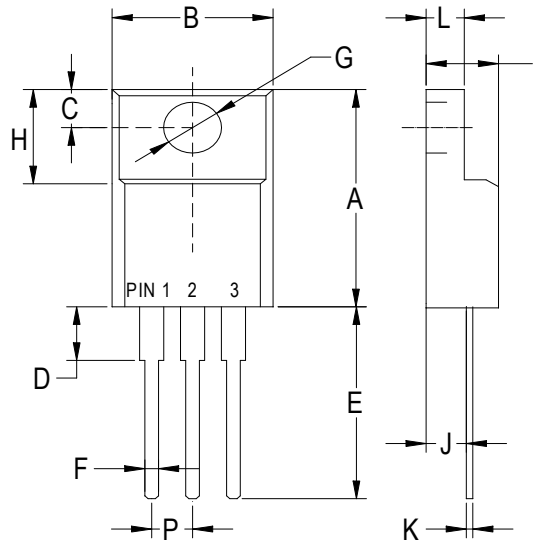

TO-220TF		
Dim	Min	Max
A	.590 (15.0)	.650 (16.5)
B	.393 (10.0)	.414 (10.5)
C	.118 (3.00)	.138 (3.50)
D	.118 (3.00)	.146 (3.70)
E	.512 (13.0)	.551 (14.0)
F	.028 (0.70)	.035 (0.90)
G	.114 (2.90)	.138 (3.50)
H	.255 (6.50)	.280 (7.10)
I	.173 (4.40)	.197 (5.00)
J	.102 (2.60)	.110 (2.80)
K	.018 (0.45)	.026 (0.65)
L	.092 (2.35)	.109 (2.75)
P	.890 (2.25)	.113 (2.85)