

SOP8 Plastic-Encapsulate MOSFETS

CJQ4824 Dual N-Channel MOSFET

$V_{(BR)DSS}$	$R_{DS(on)}$ TYP	I_D
30V	10.5mΩ@10V	10A
	14.5mΩ@4.5V	

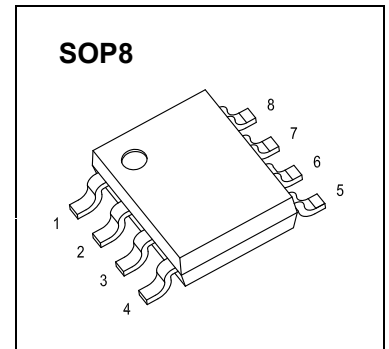

DESCRIPTION

The CJQ4824 uses advanced trench technology to provide excellent $R_{DS(ON)}$ and low gate charge. This device is suitable for use as a load switch or in PWM applications.

MARKING:



Q4824= Device code
YY=Date Code
Solid dot = Pin1 indicator
Solid dot = Green molding compound device, if none,the normal device.

Equivalent Circuit

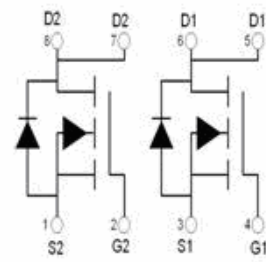

Maximum ratings ($T_a=25^{\circ}C$ unless otherwise noted)

Parameter	Symbol	Value	Unit
Drain-Source Voltage	V_{DS}	30	V
Gate-Source Voltage	V_{GS}	±20	V
Continuous Drain Current ($t \leq 10s$) (note 1)	I_D	10	A
Pulsed Drain Current (note 2)	I_{DM}	28	A
Power Dissipation	P_D	1.25	W
Thermal Resistance from Junction to Ambient ($t \leq 10s$) (note 1)	$R_{\theta JA}$	100	$^{\circ}C/W$
Junction Temperature	T_J	150	$^{\circ}C$
Storage Temperature	T_{STG}	-55~+150	$^{\circ}C$

MOSFET ELECTRICAL CHARACTERISTICS

$T_a=25\text{ }^\circ\text{C}$ unless otherwise specified

Parameter	Symbol	Test Condition	Min	Typ	Max	Unit
STATIC PARAMETERS						
Drain-source breakdown voltage	$V_{(BR)DSS}$	$V_{GS} = 0V, I_D = 250\mu A$	30			V
Zero gate voltage drain current	I_{DSS}	$V_{DS} = 30V, V_{GS} = 0V$			1	μA
Gate-body leakage current	I_{GSS}	$V_{GS} = \pm 20V, V_{DS} = 0V$			± 100	nA
Gate threshold voltage	$V_{GS(th)}$	$V_{DS} = V_{GS}, I_D = 250\mu A$	0.7	1.7	3.0	V
Drain-source on-resistance (note 3)	$R_{DS(on)}$	$V_{GS} = 10V, I_D = 10A$		10.5	15	m Ω
		$V_{GS} = 4.5V, I_D = 9A$		14.5	20	m Ω
Forward transconductance (note 3)	g_{FS}	$V_{DS} = 5V, I_D = 5A$	15			S
Diode forward voltage (note 3)	V_{SD}	$I_S = 10A, V_{GS} = 0V$			0.85	V
DYNAMIC PARAMETERS (note 4)						
Input capacitance	C_{ISS}	$V_{DS} = 15V, V_{GS} = 0V, f = 1MHz$		823		pF
Output capacitance	C_{OSS}			138		pF
Reverse transfer capacitance	C_{RSS}			100		pF
SWITCHING PARAMETERS (note 4)						
Total gate charge	Q_g	$V_{GS} = 10V, V_{DS} = 15V, I_D = 10A$		15		ns
Gate-source charge	Q_{gs}			4		ns
Gate-drain charge	Q_{gd}			5		ns
Turn-on delay time	$t_{d(on)}$	$V_{GS} = 10V, V_{DS} = 15V, R_L = 1.8\Omega, R_{GEN} = 3\Omega$			10	ns
Turn-on rise time	t_r				8	ns
Turn-off delay time	$t_{d(off)}$				32	ns
Turn-off fall time	t_f				6	ns

Notes :

1. The value of $R_{\theta JA}$ is measure with the device mounted on $1in^2$ FR-4 board with 2oz. Copper, in a still air environment with $T_a=25^\circ C$. The value in any given application depends on the user's specific board design. The current rating is based on the $t \leq 10s$ thermal resistance rating.
2. Repetitive rating : Pulse width limited by junction temperature.
3. Pulse Test : Pulse Width $\leq 300\mu s$, Duty Cycle $\leq 2\%$.
4. Guaranteed by design, not subject to production testing.

Typical Characteristics

Output Characteristics

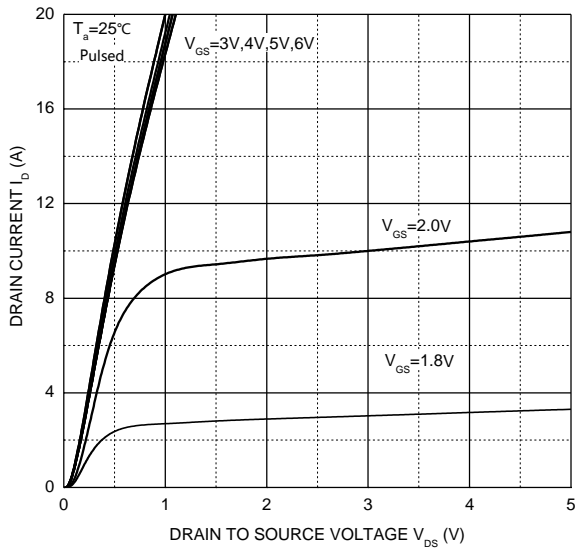

Transfer Characteristics

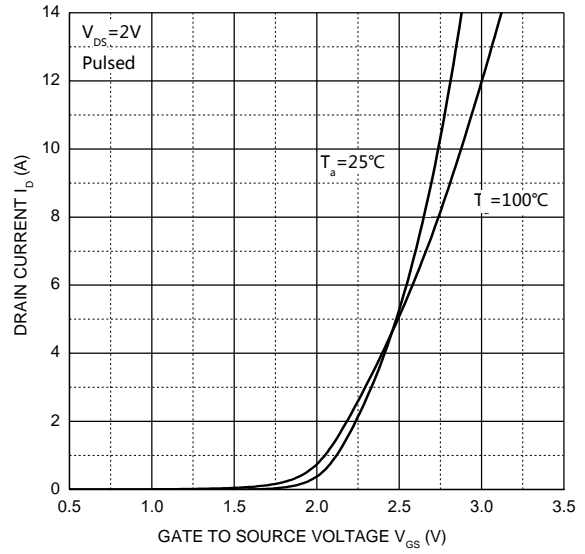

$R_{DS(ON)} - I_D$

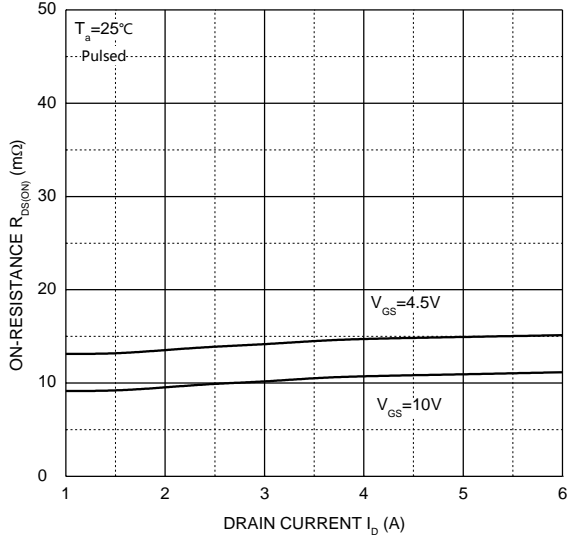

$R_{DS(ON)} - V_{GS}$

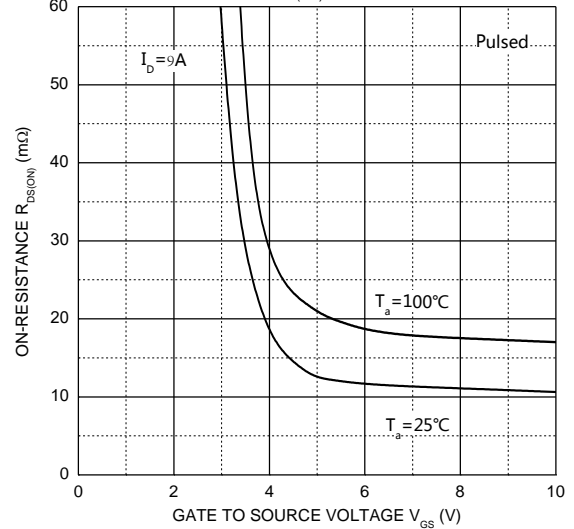

$I_S - V_{SD}$

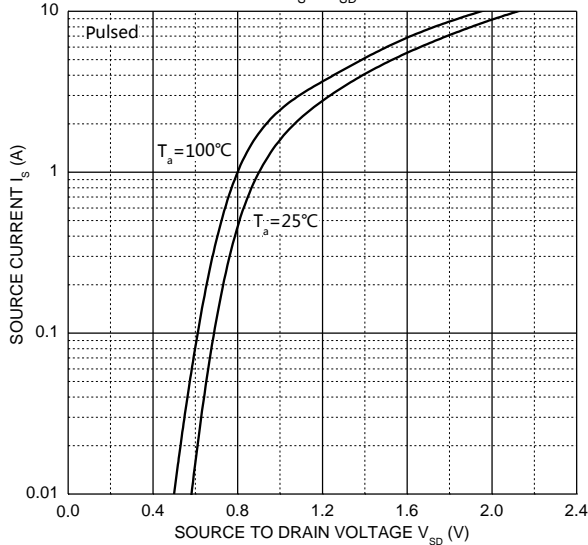

Threshold Voltage

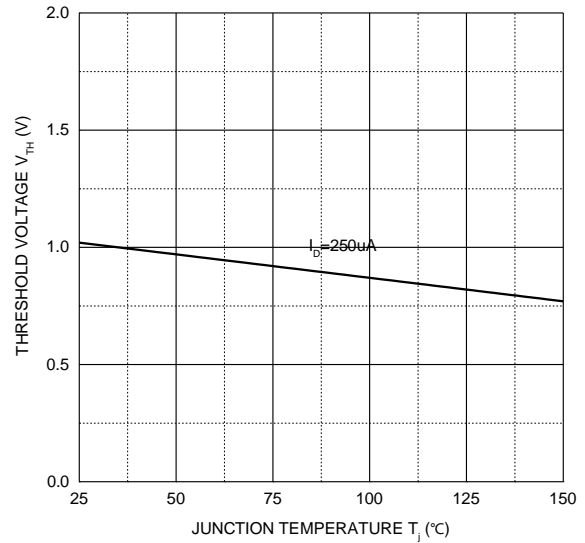

SOP8 Package Outline Dimensions

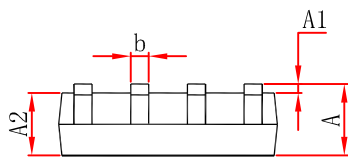
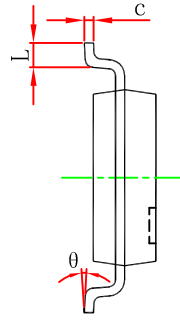
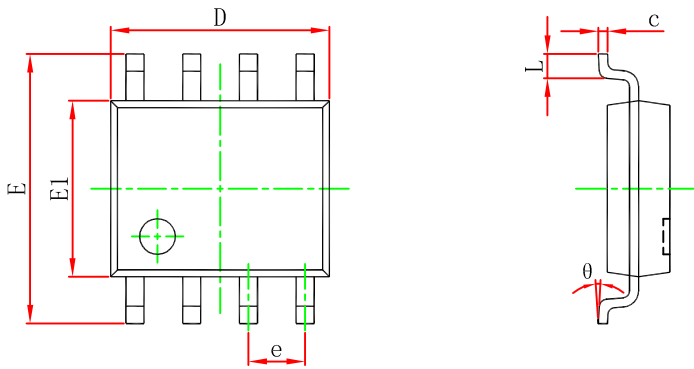

Symbol	Dimensions In Millimeters		Dimensions In Inches	
	Min	Max	Min	Max
A	1.350	1.750	0.053	0.069
A1	0.100	0.250	0.004	0.010
A2	1.350	1.550	0.053	0.061
b	0.330	0.510	0.013	0.020
c	0.170	0.250	0.007	0.010
D	4.800	5.000	0.189	0.197
e	1.270 (BSC)		0.050 (BSC)	
E	5.800	6.200	0.228	0.244
E1	3.800	4.000	0.150	0.157
L	0.400	1.270	0.016	0.050
θ	0°	8°	0°	8°

SOP8 Suggested Pad Layout

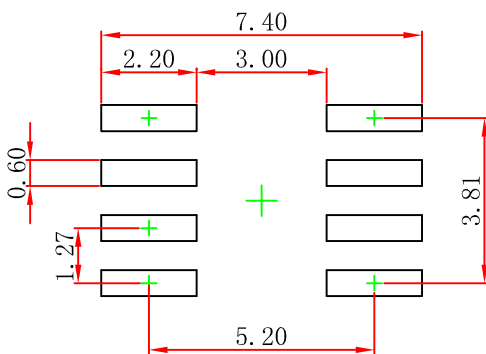

- Note:
1. Controlling dimension: in millimeters.
 2. General tolerance: $\pm 0.05\text{mm}$.
 3. The pad layout is for reference purposes only.

NOTICE

JSCJ reserves the right to make modifications, enhancements, improvements, corrections or other changes without further notice to any product herein. JSCJ does not assume any liability arising out of the application or use of any product described herein.

SOP8 Tape and Reel

SOP8 Embossed Carrier Tape

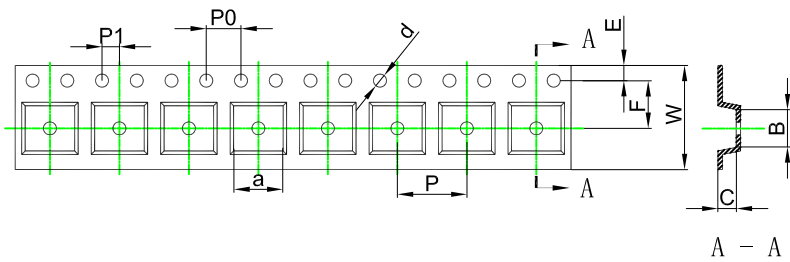

Packaging Description:

SOP8 parts are shipped in tape. The carrier tape is made from a dissipative (carbon filled) polycarbonate resin. The cover tape is a multilayer film (Heat Activated Adhesive in nature) primarily composed of polyester film, adhesive layer, sealant, and anti-static sprayed agent. These reeled parts in standard option are shipped with 2,500 units per 13" or 33cm diameter reel. The reels are clear in color and is made of polystyrene plastic (anti-static coated).

ALL DIM IN mm

Dimensions are in millimeter										
Pkg type	a	B	C	d	E	F	P0	P	P1	W
SOP8	6.40	5.40	2.10	Ø1.50	1.75	5.50	4.00	8.00	2.00	12.00

SOP8 Tape Leader and Trailer



SOP8 Reel

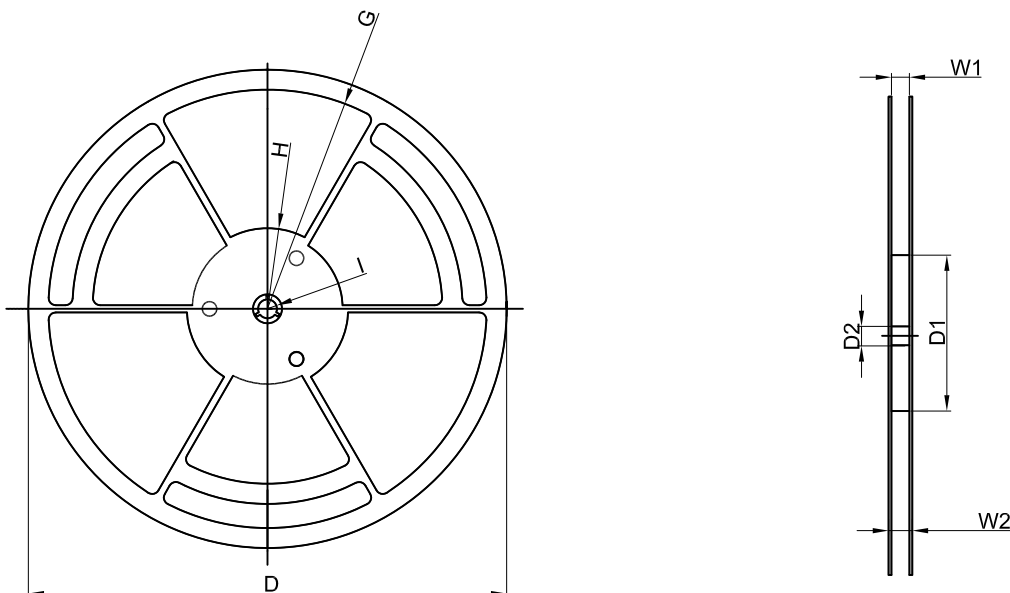

Dimensions are in millimeter								
Reel Option	D	D1	D2	G	H	I	W1	W2
13" Dia	Ø330.00	100.00	13.00	R151.00	R56.00	R6.50	12.40	17.60

REEL	Reel Size	Box	Box Size(mm)	Carton	Carton Size(mm)	G.W.(kg)
4,000 pcs	13 inch	8,000 pcs	360×360×65	64,000 pcs	565×380×390	