

TSSOP8 Plastic-Encapsulate MOSFETS

CJS8810 Dual N-Channel MOSFET

$V_{(BR)DSS}$	$R_{DS(on)TYP}$	I_D
20V	14.2mΩ@4.5V	7A
	15.4mΩ@3.8V	
	18.2mΩ@2.5V	
	26mΩ@1.8V	

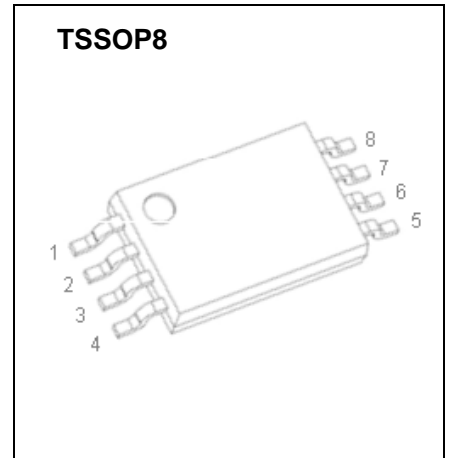

DESCRIPTION

The CJS8810 uses advanced trench technology to provide excellent $R_{DS(ON)}$ and low gate charge. It is ESD protected. This device is suitable for use as a uni-directional or bi-directional load switch, facilitated by its common-drain configuration.

MARKING:

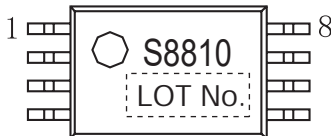

Equivalent Circuit

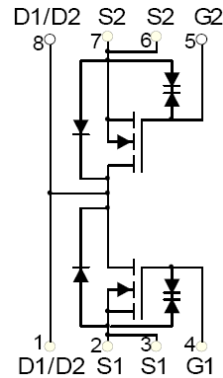

MAXIMUM RATINGS ($T_a=25^{\circ}C$ unless otherwise noted)

Parameter	Symbol	Value	Unit
Drain-Source Voltage	V_{DS}	20	V
Gate-Source Voltage	V_{GS}	±12	V
Continuous Drain Current	I_D	7	A
Pulsed Drain Current	I_{DM}^*	30	A
Thermal Resistance from Junction to Ambient	$R_{\theta JA}$	62.5	$^{\circ}C/W$
Junction Temperature	T_j	150	$^{\circ}C$
Storage Temperature	T_{stg}	-55~+150	$^{\circ}C$
Lead Temperature for Soldering Purposes(1/8" from case for 10 s)	T_L	260	$^{\circ}C$

*Repetitive rating: Pulse width limited by junction temperature.

MOSFET ELECTRICAL CHARACTERISTICS

$T_a=25^\circ\text{C}$ unless otherwise specified

Parameter	Symbol	Test Condition	Min	Typ	Max	Unit
STATIC PARAMETERS						
Drain-source breakdown voltage	$V_{(BR)DSS}$	$V_{GS} = 0V, I_D = 250\mu A$	20			V
Zero gate voltage drain current	I_{DSS}	$V_{DS} = 16V, V_{GS} = 0V$			1	μA
Gate-body leakage current	I_{GSS}	$V_{GS} = \pm 4.5V, V_{DS} = 0V$			± 1	μA
		$V_{GS} = \pm 8V, V_{DS} = 0V$			± 10	μA
Gate threshold voltage (note 1)	$V_{GS(th)}$	$V_{DS} = V_{GS}, I_D = 250\mu A$	0.4		1	V
Drain-source on-resistance (note 1)	$R_{DS(on)}$	$V_{GS} = 10V, I_D = 3A$		14	17	m Ω
		$V_{GS} = 4.5V, I_D = 3A$		14.2	19	m Ω
		$V_{GS} = 3.8V, I_D = 3A$		15.4	21	m Ω
		$V_{GS} = 2.5V, I_D = 3A$		18.2	23	m Ω
		$V_{GS} = 1.8V, I_D = 3A$		26	32	m Ω
Forward transconductance (note 1)	g_{FS}	$V_{DS} = 5V, I_D = 7A$	9			S
Diode forward voltage (note 1)	V_{SD}	$I_S = 1A, V_{GS} = 0V$			1	V
DYNAMIC PARAMETERS (note 2)						
Input Capacitance	C_{iss}	$V_{DS} = 10V, V_{GS} = 0V, f = 1MHz$		1150		pF
Output Capacitance	C_{oss}			185		pF
Reverse Transfer Capacitance	C_{rss}			145		pF
Total gate charge	Q_g	$V_{DS} = 10V, V_{GS} = 4.5V, I_D = 7A$		15		nC
Gate-source charge	Q_{gs}			0.8		nC
Gate-drain charge	Q_{gd}			3.2		nC
SWITCHING PARAMETERS (note 2)						
Turn-on delay time	$t_{d(on)}$	$V_{GS} = 5V, V_{DD} = 10V,$ $R_L = 1.35\Omega, R_{GEN} = 3\Omega$		6		ns
Turn-on rise time	t_r			13		ns
Turn-off delay time	$t_{d(off)}$			52		ns
Turn-off fall time	t_f			16		ns

Notes :

1. Pulse Test : Pulse width $\leq 300\mu s$, duty cycle $\leq 0.5\%$.
2. Guaranteed by design, not subject to production testing.

Typical Characteristics

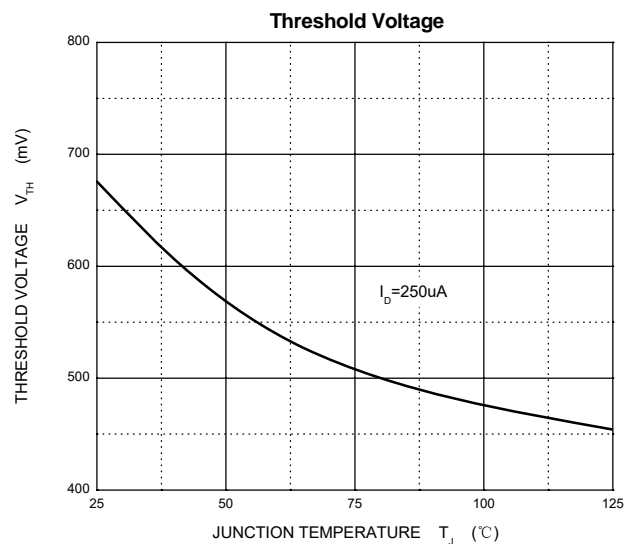
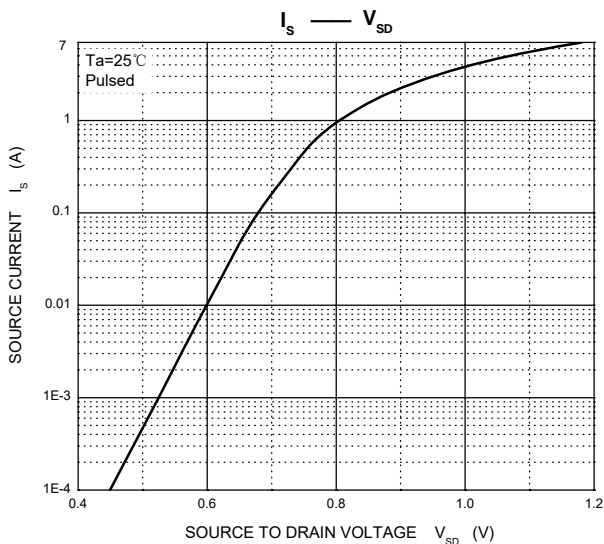
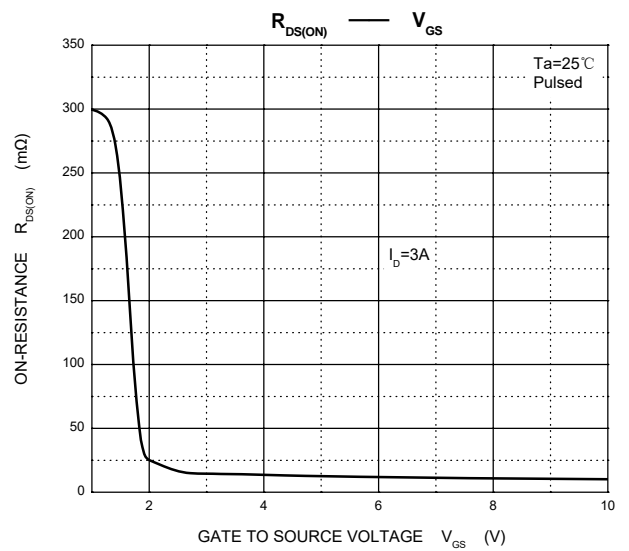
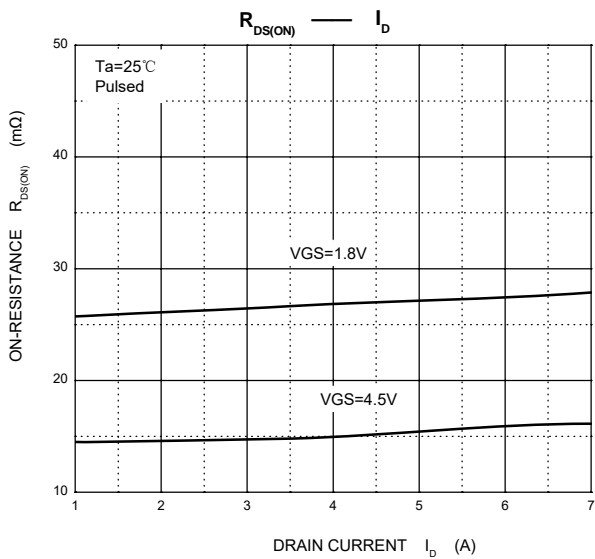
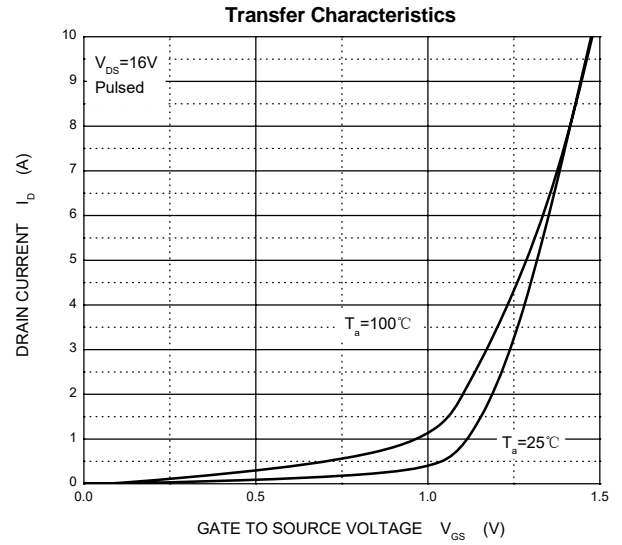
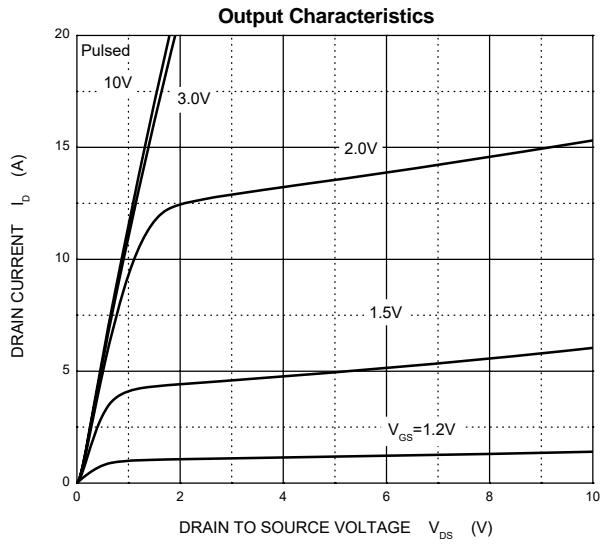

TSSOP8 Package Outline Dimensions

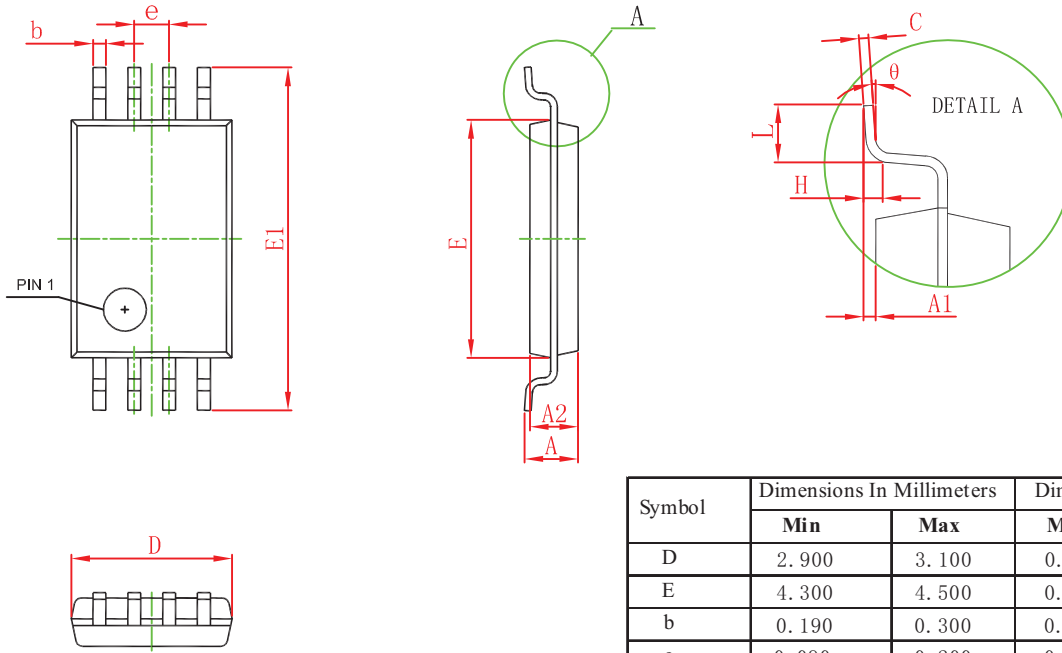

Symbol	Dimensions In Millimeters		Dimensions In Inches	
	Min	Max	Min	Max
D	2.900	3.100	0.114	0.122
E	4.300	4.500	0.169	0.177
b	0.190	0.300	0.007	0.012
c	0.090	0.200	0.004	0.008
E1	6.250	6.550	0.246	0.258
A		1.200		0.047
A2	0.800	1.000	0.031	0.039
A1	0.050	0.150	0.002	0.006
e	0.65 (BSC)		0.026 (BSC)	
L	0.500	0.700	0.020	0.028
H	0.25(TYP)		0.01(TYP)	
θ	1°	7°	1°	7°

TSSOP8 Suggested Pad Layout

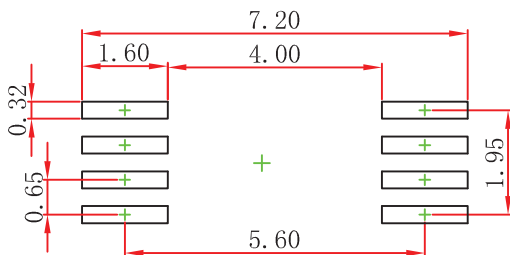

- Note:
1. Controlling dimension: in millimeters.
 2. General tolerance: $\pm 0.05\text{mm}$.
 3. The pad layout is for reference purposes only.

NOTICE

JSCJ reserves the right to make modifications, enhancements, improvements, corrections or other changes without further notice to any product herein. JSCJ does not assume any liability arising out of the application or use of any product described herein.

TSSOP8 Tape and Reel

TSSOP8 Embossed Carrier Tape

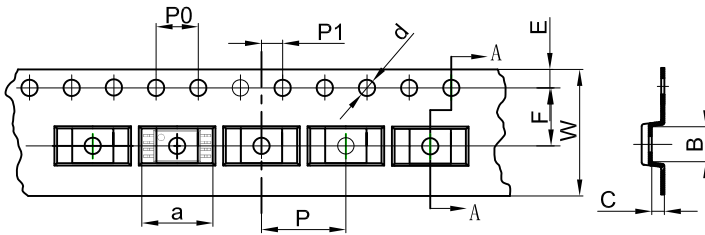

Packaging Description:

TSSOP8 parts are shipped in tape. The carrier tape is made from a dissipative (carbon filled) polycarbonate resin. The cover tape is a multilayer film (Heat Activated Adhesive in nature) primarily composed of polyester film, adhesive layer, sealant, and anti-static sprayed agent. These reeled parts in standard option are shipped with 3,000 units per 13" or 33cm diameter reel. The reels are clear in color and is made of polystyrene plastic (anti-static coated).

ALL DIM IN mm

Dimensions are in millimeter										
Pkg type	a	B	C	d	E	F	P0	P	P1	W
TSSOP8	6.76	3.30	1.20	Ø1.50	1.75	5.50	4.00	8.00	2.00	12.00

TSSOP8 Tape Leader and Trailer

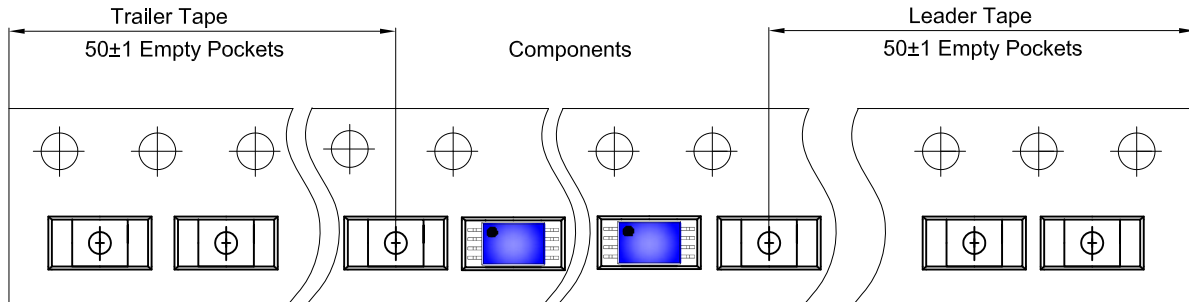

TSSOP8 Reel

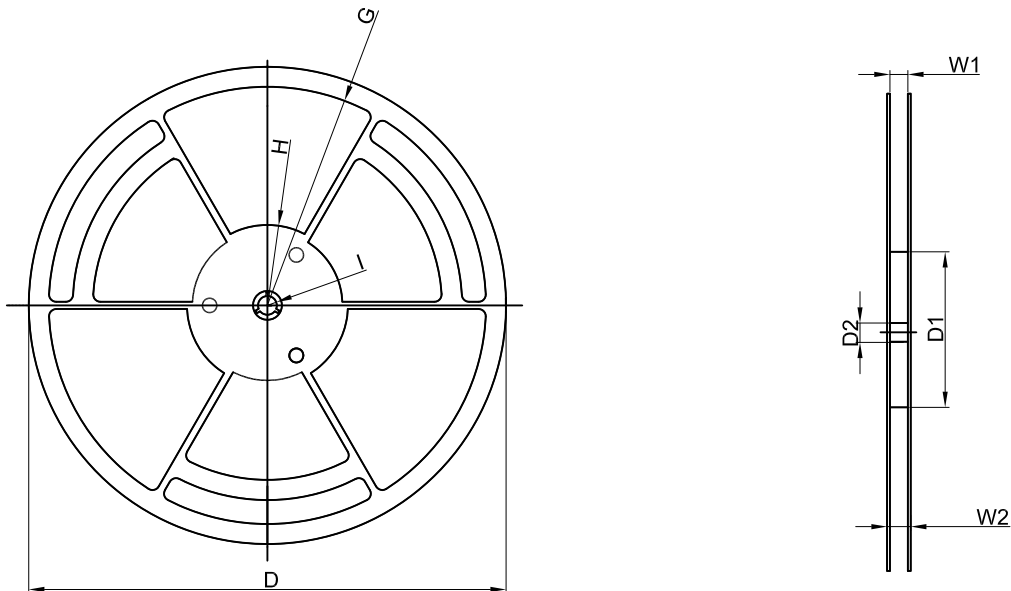

Dimensions are in millimeter								
Reel Option	D	D1	D2	G	H	I	W1	W2
13"Dia	Ø330.00	100.00	13.00	R151.00	R56.00	R6.50	12.40	17.60

REEL	Reel Size	Box	Box Size(mm)	Carton	Carton Size(mm)	G.W.(kg)
3,000 pcs	13 inch	3,000 pcs	336×336×48	24,000 pcs	445×355×365	