

## TSSOP8 Plastic-Encapsulate MOSFETS

### CJS2016 Dual N-Channel MOSFET

| $V_{(BR)DSS}$ | $R_{DS(on)TYP}$ | $I_D$ |
|---------------|-----------------|-------|
| 20V           | 15.7 mΩ@4.5V    | 6A    |
|               | 20 mΩ@2.5V      |       |

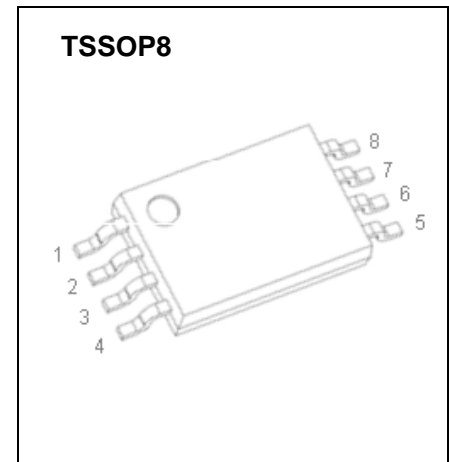

#### FEATURE

- TrenchFET Power MOSFET
- Excellent  $R_{DS(on)}$
- Low Gate Charge
- High Power and Current Handling Capability
- Surface Mount Package

#### APPLICATION

- Battery Protection
- Load Switch
- Power Management

#### MARKING

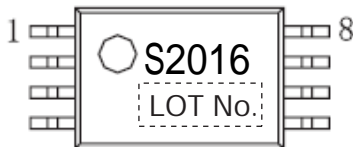

#### Equivalent Circuit

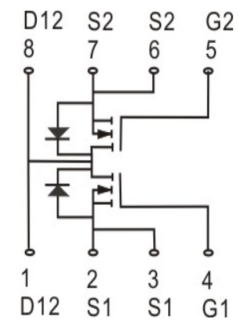

#### ABSOLUTE MAXIMUM RATINGS ( $T_a=25^{\circ}C$ unless otherwise noted)

| Parameter  | Symbol          | Value    | Unit          |
|--|-----------------|----------|---------------|
| Drain-Source Voltage   | $V_{DS}$        | 20       | V             |
| Gate-Source Voltage  | $V_{GS}$        | ±10      | V             |
| Continuous Drain Current   | $I_D$           | 6        | A             |
| Pulsed Drain Current (note 1)                                    | $I_{DM}$        | 25       | A             |
| Thermal Resistance from Junction to Ambient (note 2)             | $R_{\theta JA}$ | 62.5     | $^{\circ}C/W$ |
| Junction Temperature   | $T_J$           | 150      | $^{\circ}C$   |
| Storage Temperature  | $T_{STG}$       | -55~+150 | $^{\circ}C$   |
| Lead Temperature for Soldering Purposes(1/8" from case for 10 s) | $T_L$           | 260      | $^{\circ}C$   |

## MOSFET ELECTRICAL CHARACTERISTICS

$T_a=25^\circ\text{C}$  unless otherwise specified

| Parameter                                 | Symbol        | Test Condition   | Min  | Typ  | Max       | Unit       |
|---|---------------|--|------|------|-----------|------------|
| <b>STATIC CHARACTERISTICS</b>             |               |  |      |      |           |            |
| Drain-source breakdown voltage            | $V_{(BR)DSS}$ | $V_{GS} = 0V, I_D = 250\mu A$                                  | 20   |      |           | V          |
| Zero gate voltage drain current           | $I_{DSS}$     | $V_{DS} = 18V, V_{GS} = 0V$                                    |      |      | 1         | $\mu A$    |
| Gate-body leakage current                 | $I_{GSS}$     | $V_{GS} = \pm 10V, V_{DS} = 0V$                                |      |      | $\pm 100$ | nA         |
| Gate threshold voltage (note 3)           | $V_{GS(th)}$  | $V_{DS} = V_{GS}, I_D = 250\mu A$                              | 0.45 |      | 1.2       | V          |
| Drain-source on-resistance (note 3)       | $R_{DS(on)}$  | $V_{GS} = 4.5V, I_D = 6A$                                      |      | 15.7 | 20        | m $\Omega$ |
|   |               | $V_{GS} = 2.5V, I_D = 5A$                                      |      | 20   | 27        | m $\Omega$ |
| Forward transconductance (note 3)         | $g_{FS}$      | $V_{DS} = 5V, I_D = 4.5A$                                      |      | 10   |           | S          |
| Diode forward voltage (note 3)            | $V_{SD}$      | $I_S = 1.25A, V_{GS} = 0V$                                     |      |      | 1.2       | V          |
| <b>DYNAMIC CHARACTERISTICS (note 4)</b>   |               |  |      |      |           |            |
| Input Capacitance                         | $C_{iss}$     | $V_{DS} = 8V, V_{GS} = 0V, f = 1MHz$                           |      | 800  |           | pF         |
| Output Capacitance                        | $C_{oss}$     |  |      | 155  |           | pF         |
| Reverse Transfer Capacitance              | $C_{rss}$     |  |      | 125  |           | pF         |
| <b>SWITCHING CHARACTERISTICS (note 4)</b> |               |  |      |      |           |            |
| Turn-on delay time                        | $t_{d(on)}$   | $V_{DD} = 10V, V_{GS} = 4V,$<br>$I_D = 1A, R_{GEN} = 10\Omega$ |      | 18   |           | ns         |
| Turn-on rise time                         | $t_r$         |  |      | 5    |           | ns         |
| Turn-off delay time                       | $t_{d(off)}$  |  |      | 43   |           | ns         |
| Turn-off fall time                        | $t_f$         |  |      | 20   |           | ns         |
| Total Gate Charge                         | $Q_g$         | $V_{DS} = 10V, V_{GS} = 4.5V, I_D = 4A$                        |      | 11   |           | nC         |
| Gate-Source Charge                        | $Q_{gs}$      |  |      | 2.3  |           | nC         |
| Gate-Drain Charge                         | $Q_{gd}$      |  |      | 2.5  |           | nC         |

### Notes :

- 1.Repetitive rating: Pulse width limited by maximum junction temperature
- 2.Surface Mounted on FR4 board,  $t \leq 10$  sec.
3. Pulse test : Pulse width  $\leq 300\mu s$ , duty cycle  $\leq 2\%$ .
4. Guaranteed by design, not subject to production.

# Typical Characteristics

Output Characteristics

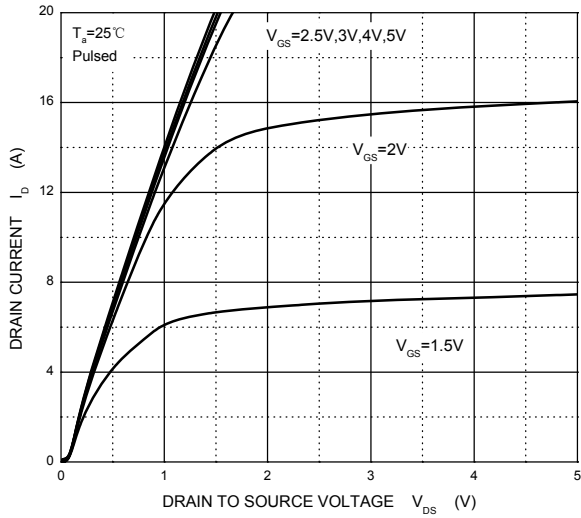

Transfer Characteristics

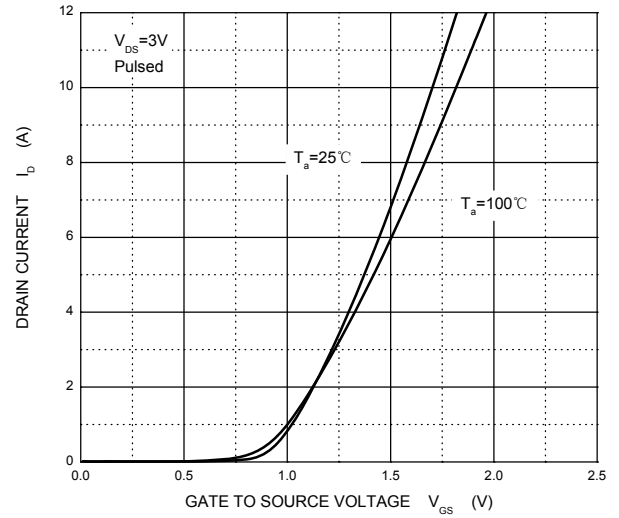

$R_{DS(ON)}$  —  $I_D$

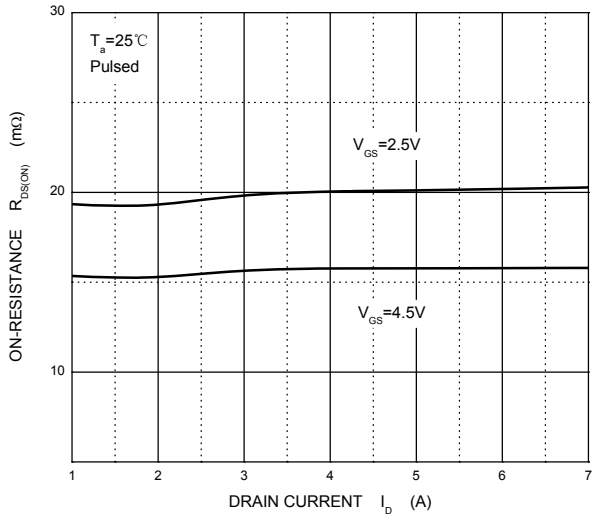

$R_{DS(ON)}$  —  $V_{GS}$

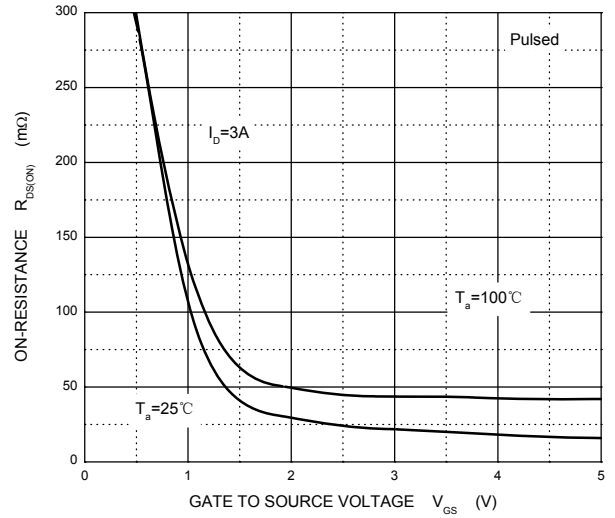

$I_S$  —  $V_{SD}$

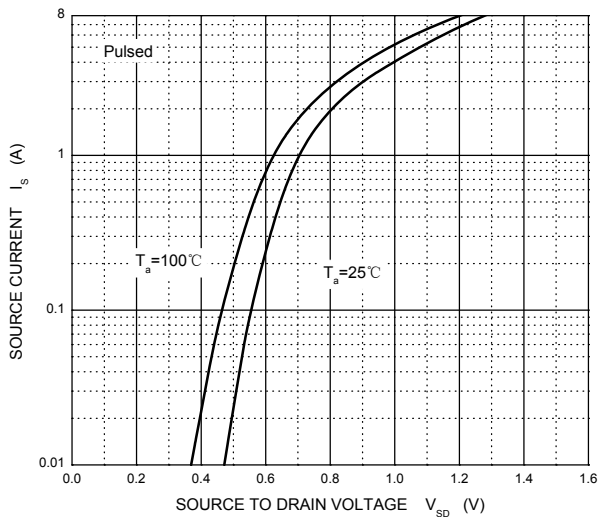

Threshold Voltage

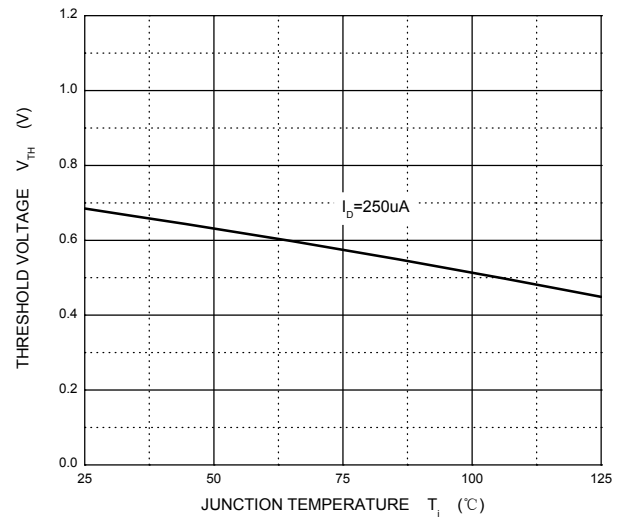

## TSSOP8 Package Outline Dimensions

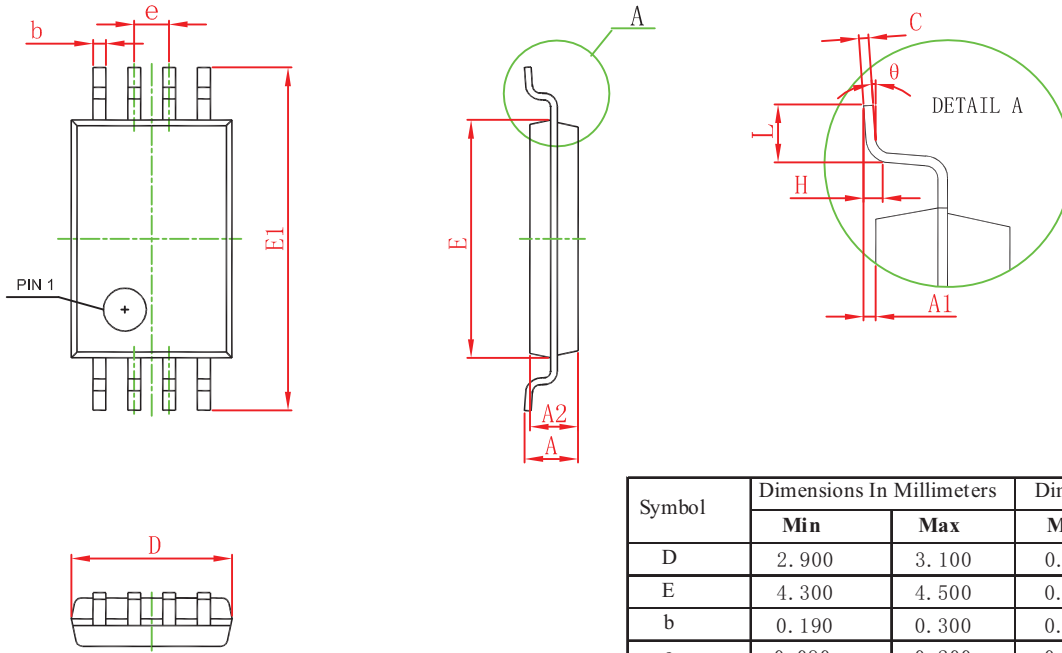

| Symbol   | Dimensions In Millimeters |       | Dimensions In Inches |       |
|----------|---------------------------|-------|----------------------|-------|
|          | Min                       | Max   | Min                  | Max   |
| D        | 2.900                     | 3.100 | 0.114                | 0.122 |
| E        | 4.300                     | 4.500 | 0.169                | 0.177 |
| b        | 0.190                     | 0.300 | 0.007                | 0.012 |
| c        | 0.090                     | 0.200 | 0.004                | 0.008 |
| E1       | 6.250                     | 6.550 | 0.246                | 0.258 |
| A        |                           | 1.200 |                      | 0.047 |
| A2       | 0.800                     | 1.000 | 0.031                | 0.039 |
| A1       | 0.050                     | 0.150 | 0.002                | 0.006 |
| e        | 0.65 (BSC)                |       | 0.026 (BSC)          |       |
| L        | 0.500                     | 0.700 | 0.020                | 0.028 |
| H        | 0.25(TYP)                 |       | 0.01(TYP)            |       |
| $\theta$ | 1°                        | 7°    | 1°                   | 7°    |

## TSSOP8 Suggested Pad Layout

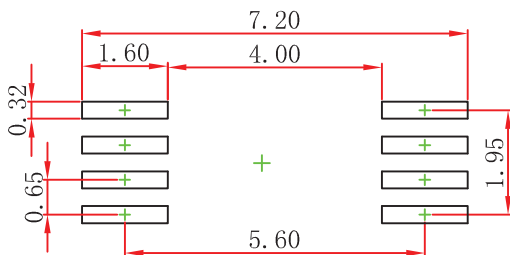

- Note:
1. Controlling dimension: in millimeters.
  2. General tolerance:  $\pm 0.05$  mm.
  3. The pad layout is for reference purposes only.

### NOTICE

JSCJ reserves the right to make modifications, enhancements, improvements, corrections or other changes without further notice to any product herein. JSCJ does not assume any liability arising out of the application or use of any product described herein.

# TSSOP8 Tape and Reel

## TSSOP8 Embossed Carrier Tape

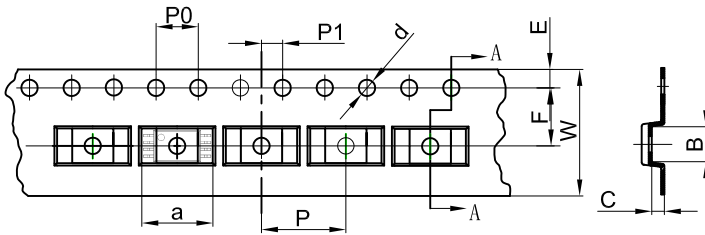

### Packaging Description:

TSSOP8 parts are shipped in tape. The carrier tape is made from a dissipative (carbon filled) polycarbonate resin. The cover tape is a multilayer film (Heat Activated Adhesive in nature) primarily composed of polyester film, adhesive layer, sealant, and anti-static sprayed agent. These reeled parts in standard option are shipped with 3,000 units per 13" or 33cm diameter reel. The reels are clear in color and is made of polystyrene plastic (anti-static coated).

ALL DIM IN mm

| Dimensions are in millimeter |      |      |      |       |      |      |      |      |      |       |
|------------------------------|------|------|------|-------|------|------|------|------|------|-------|
| Pkg type                     | a    | B    | C    | d     | E    | F    | P0   | P    | P1   | W     |
| TSSOP8                       | 6.76 | 3.30 | 1.20 | Ø1.50 | 1.75 | 5.50 | 4.00 | 8.00 | 2.00 | 12.00 |

## TSSOP8 Tape Leader and Trailer

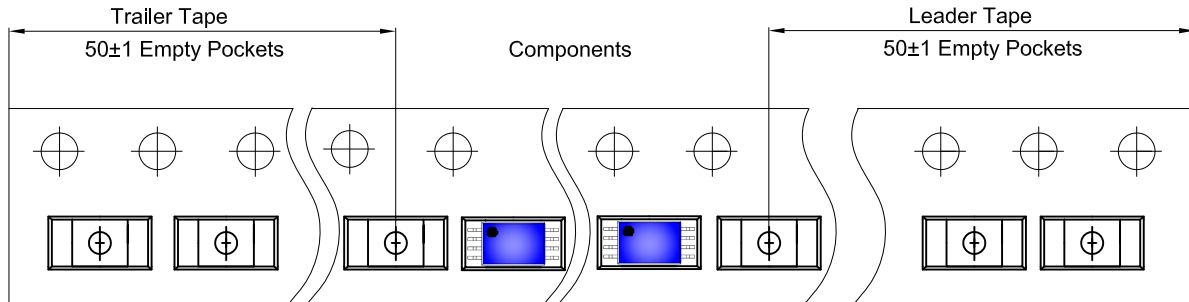

## TSSOP8 Reel

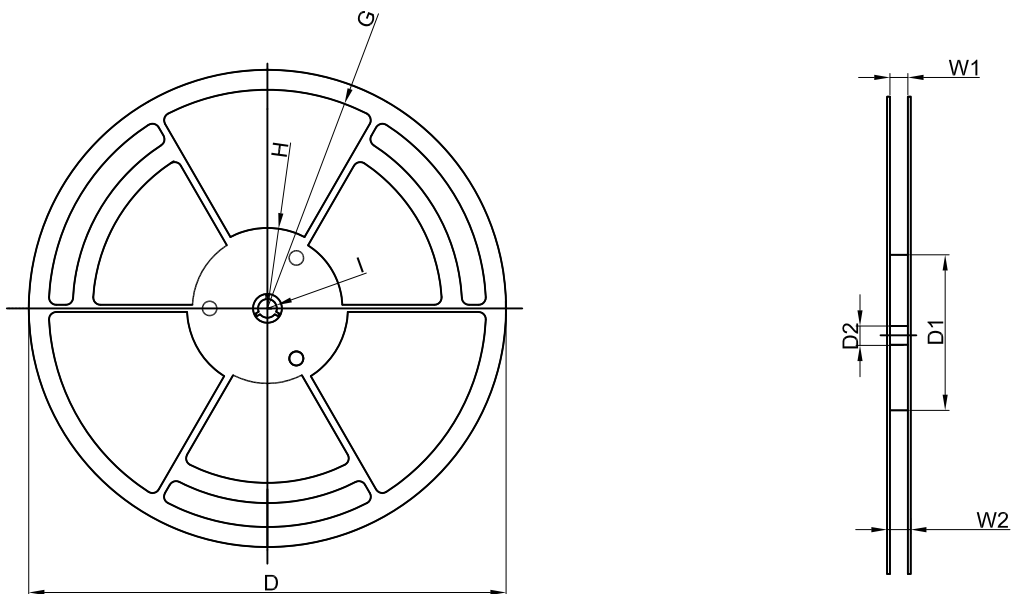

| Dimensions are in millimeter |         |        |       |         |        |       |       |       |
|------------------------------|---------|--------|-------|---------|--------|-------|-------|-------|
| Reel Option                  | D       | D1     | D2    | G       | H      | I     | W1    | W2    |
| 13"Dia                       | Ø330.00 | 100.00 | 13.00 | R151.00 | R56.00 | R6.50 | 12.40 | 17.60 |

| REEL      | Reel Size | Box       | Box Size(mm) | Carton     | Carton Size(mm) | G.W.(kg) |
|-----------|-----------|-----------|--------------|------------|-----------------|----------|
| 3,000 pcs | 13 inch   | 3,000 pcs | 336×336×48   | 24,000 pcs | 445×355×365     |          |