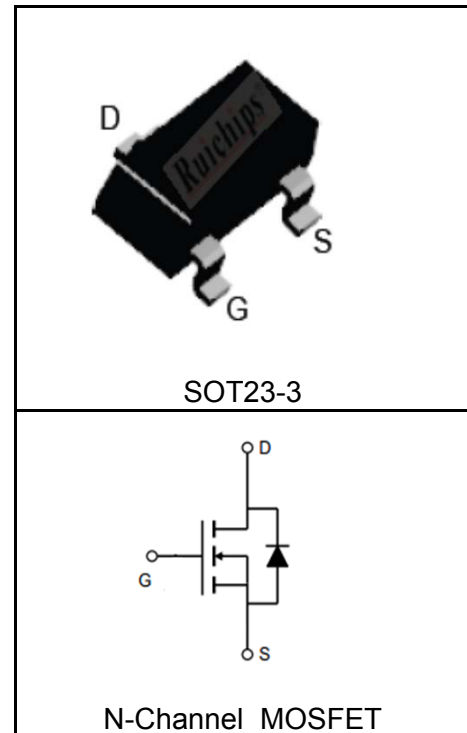

**Features**

- 20V/6A,  
 $R_{DS(ON)} = 10m\Omega(Typ.)@V_{GS}=4.5V$   
 $R_{DS(ON)} = 15m\Omega(Typ.)@V_{GS}=2.5V$
- Low  $R_{DS(ON)}$
- Super High Dense Cell Design
- Reliable and Rugged
- Lead Free and Green Devices Available (RoHS Compliant)

**Pin Description**

**Applications**

- Power Management

**Absolute Maximum Ratings**

Symbol	Parameter	Rating	Unit
<b>Common Ratings</b> ( $T_A=25^\circ C$ Unless Otherwise Noted)			
$V_{DSS}$	Drain-Source Voltage	20	V
$V_{GSS}$	Gate-Source Voltage	$\pm 12$	
$T_J$	Maximum Junction Temperature	150	$^\circ C$
$T_{STG}$	Storage Temperature Range	-55 to 150	$^\circ C$
$I_S$	Diode Continuous Forward Current	$T_A=25^\circ C$ 1.7	A
<b>Mounted on Large Heat Sink</b>			
$I_{DP}^{①}$	300 $\mu s$ Pulse Drain Current Tested	$T_A=25^\circ C$ 24	A
$I_D^{②}$	Continuous Drain Current( $V_{GS}=4.5V$ )	$T_A=25^\circ C$ 6	A
		$T_A=70^\circ C$ 4.5	
$P_D$	Maximum Power Dissipation	$T_A=25^\circ C$ 1.25	W
		$T_A=70^\circ C$ 0.75	
$R_{\theta JC}$	Thermal Resistance-Junction to Case	-	$^\circ C/W$
$R_{\theta JA}^{③}$	Thermal Resistance-Junction to Ambient	100	$^\circ C/W$
<b>Drain-Source Avalanche Ratings</b>			
$E_{AS}^{④}$	Avalanche Energy, Single Pulsed	TBD	mJ

**Electrical Characteristics** ( $T_A=25^\circ\text{C}$  Unless Otherwise Noted)

Symbol	Parameter	Test Condition	RU207C			Unit
			Min.	Typ.	Max.	
<b>Static Characteristics</b>						
$BV_{DSS}$	Drain-Source Breakdown Voltage	$V_{GS}=0V, I_{DS}=250\mu A$	20			V
$I_{DSS}$	Zero Gate Voltage Drain Current	$V_{DS}=20V, V_{GS}=0V$			1	$\mu A$
		$T_J=125^\circ\text{C}$			30	
$V_{GS(th)}$	Gate Threshold Voltage	$V_{DS}=V_{GS}, I_{DS}=250\mu A$	0.5	0.7	1.5	V
$I_{GSS}$	Gate Leakage Current	$V_{GS}=\pm 10V, V_{DS}=0V$			$\pm 100$	nA
$R_{DS(ON)}^{(5)}$	Drain-Source On-state Resistance	$V_{GS}=4.5V, I_{DS}=6A$		10	13	$m\Omega$
		$V_{GS}=2.5V, I_{DS}=5A$		15	18	$m\Omega$
<b>Diode Characteristics</b>						
$V_{SD}^{(5)}$	Diode Forward Voltage	$I_{SD}=1A, V_{GS}=0V$			1	V
$t_{rr}$	Reverse Recovery Time	$I_{SD}=1A, di_{SD}/dt=100A/\mu s$		15		ns
$Q_{rr}$	Reverse Recovery Charge			8		nC
<b>Dynamic Characteristics</b> <sup>(6)</sup>						
$R_G$	Gate Resistance	$V_{GS}=0V, V_{DS}=0V, F=1\text{MHz}$		1.5		$\Omega$
$C_{iss}$	Input Capacitance	$V_{GS}=0V,$ $V_{DS}=10V,$ Frequency=1.0MHz		590		pF
$C_{oss}$	Output Capacitance			125		
$C_{rss}$	Reverse Transfer Capacitance			90		
$t_{d(ON)}$	Turn-on Delay Time	$V_{DD}=10V, I_{DS}=6A,$ $V_{GEN}=4.5V, R_G=6\Omega$		8		ns
$t_r$	Turn-on Rise Time			15		
$t_{d(OFF)}$	Turn-off Delay Time			33		
$t_f$	Turn-off Fall Time			13		
<b>Gate Charge Characteristics</b> <sup>(6)</sup>						
$Q_g$	Total Gate Charge	$V_{DS}=16V, V_{GS}=4.5V,$ $I_{DS}=6A$		10		nC
$Q_{gs}$	Gate-Source Charge			1.6		
$Q_{gd}$	Gate-Drain Charge			3.4		

- Notes:
- ① Pulse width limited by safe operating area.
  - ② Calculated continuous current based on maximum allowable junction temperature.
  - ③ When mounted on 1 inch square copper board,  $t \leq 10\text{sec}$ . The value in any given application depends on the user's specific board design.
  - ④ Limited by  $T_{Jmax}$ . Starting  $T_J = 25^\circ\text{C}$ .
  - ⑤ Pulse test; Pulse width  $\leq 300\mu s$ , duty cycle  $\leq 2\%$ .
  - ⑥ Guaranteed by design, not subject to production testing.

**Ordering and Marking Information**

<b>Device</b>	<b>Marking<sup>①</sup></b>	<b>Package</b>	<b>Packaging</b>	<b>Quantity</b>	<b>Reel Size</b>	<b>Tape width</b>
RU207C	4XYWW	SOT23-3	Tape&Reel	3000	7"	8mm

① The following characters could be different and means:

X =Assembly site code

Y =Year

WW =Work Week

**Typical Characteristics**

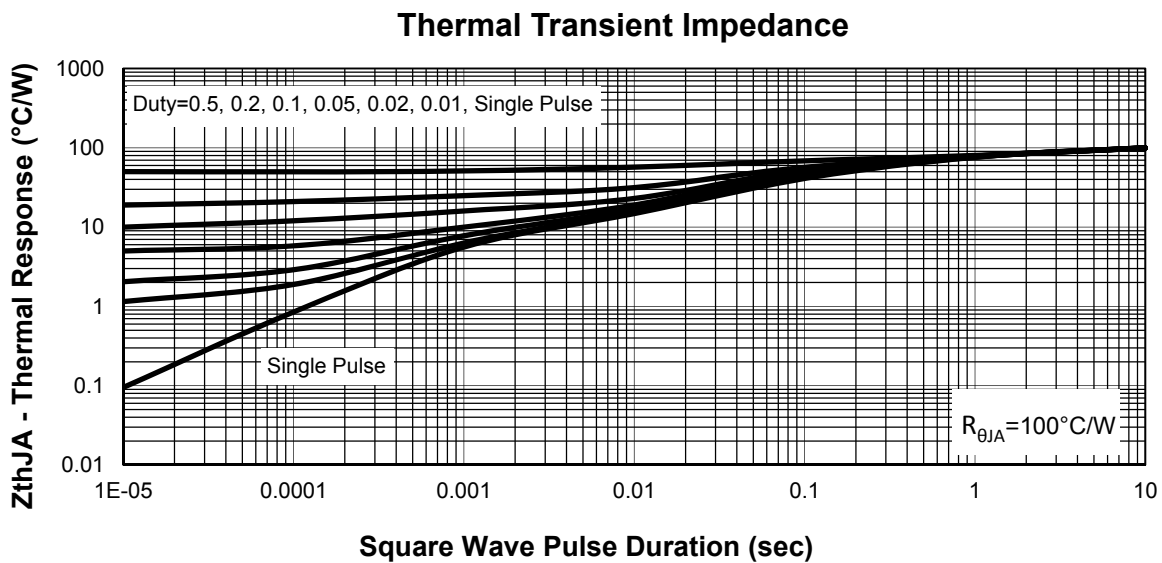
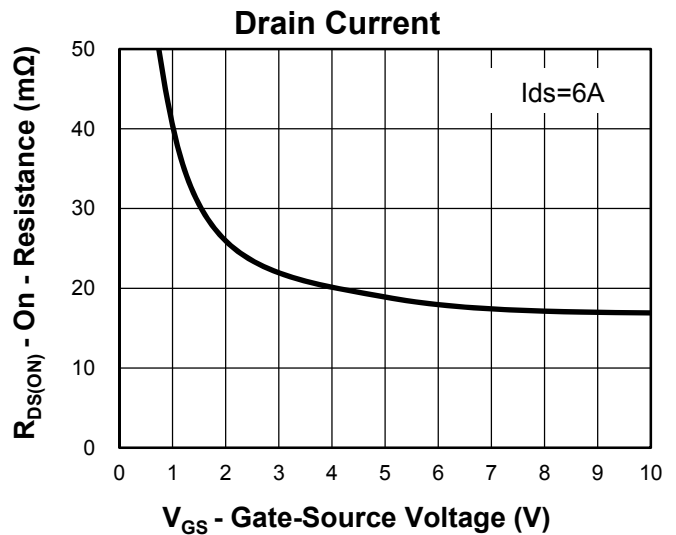
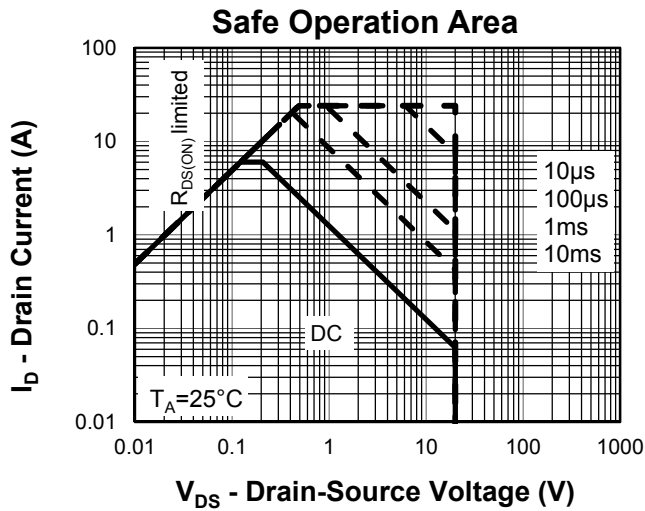
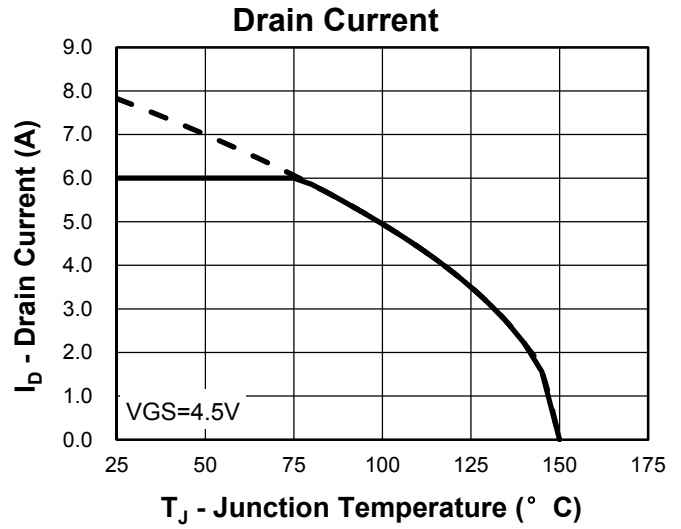
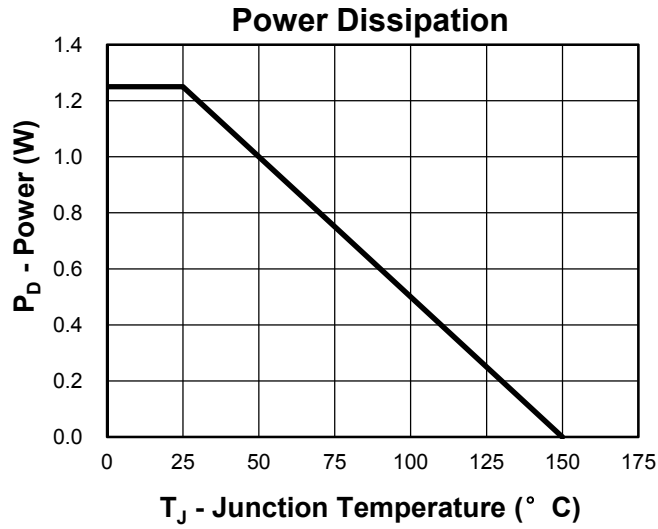

**Typical Characteristics**

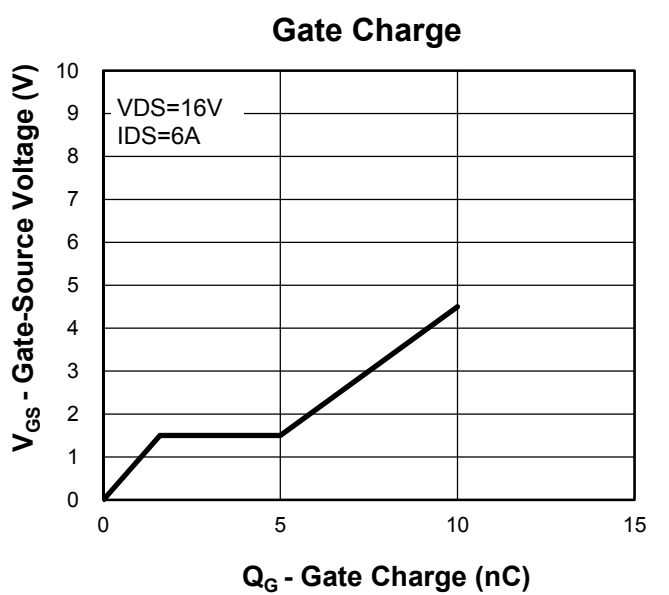
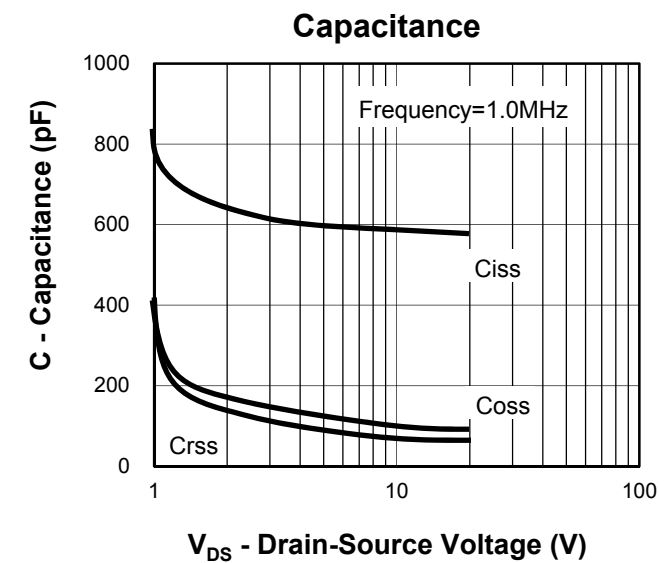
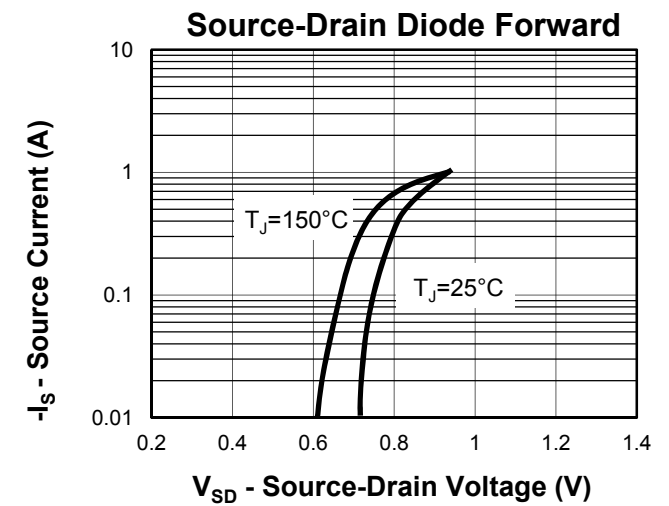
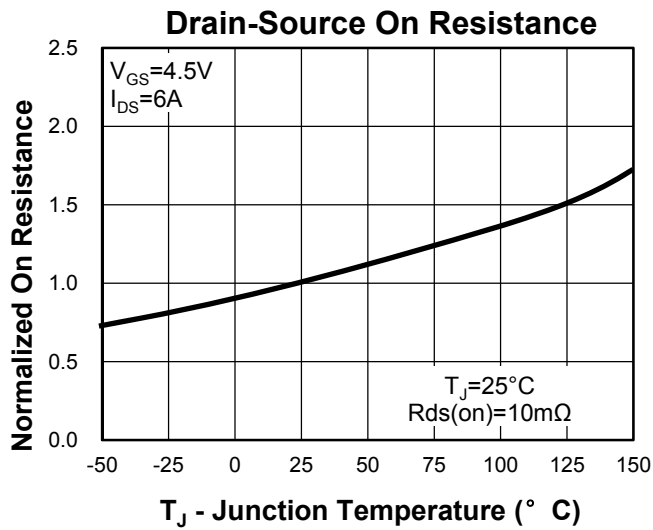
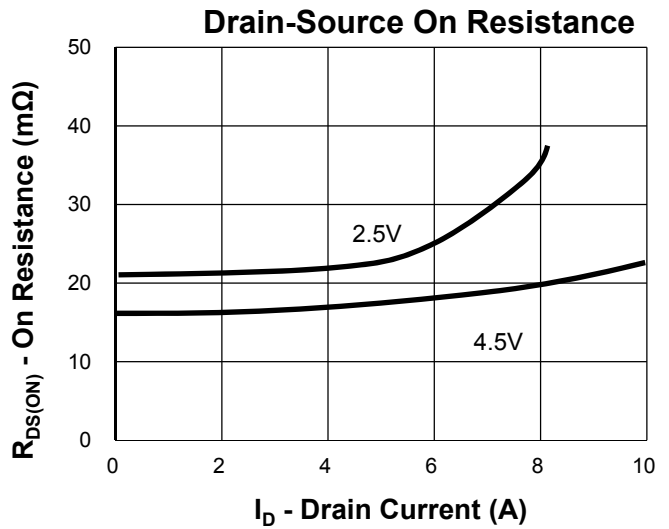
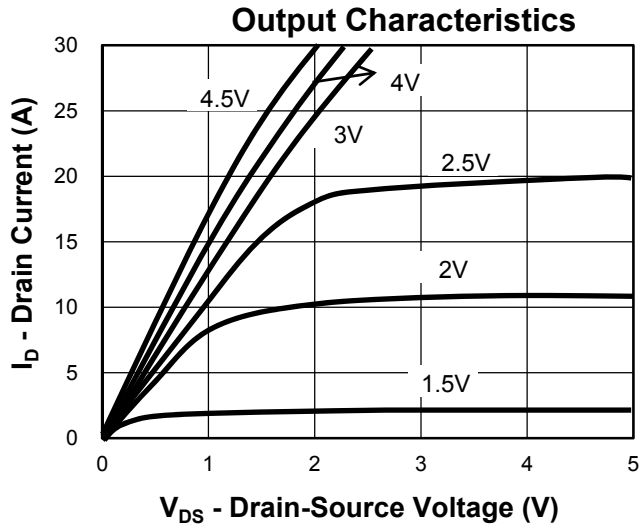

**Avalanche Test Circuit and Waveforms**

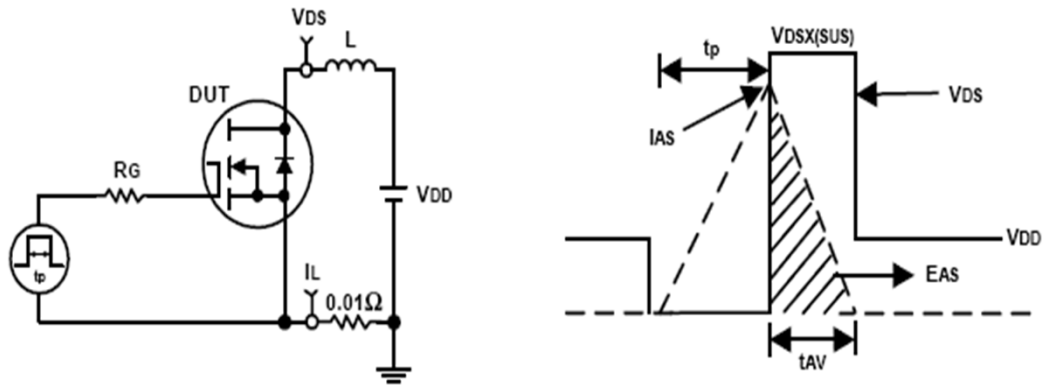

**Switching Time Test Circuit and Waveforms**

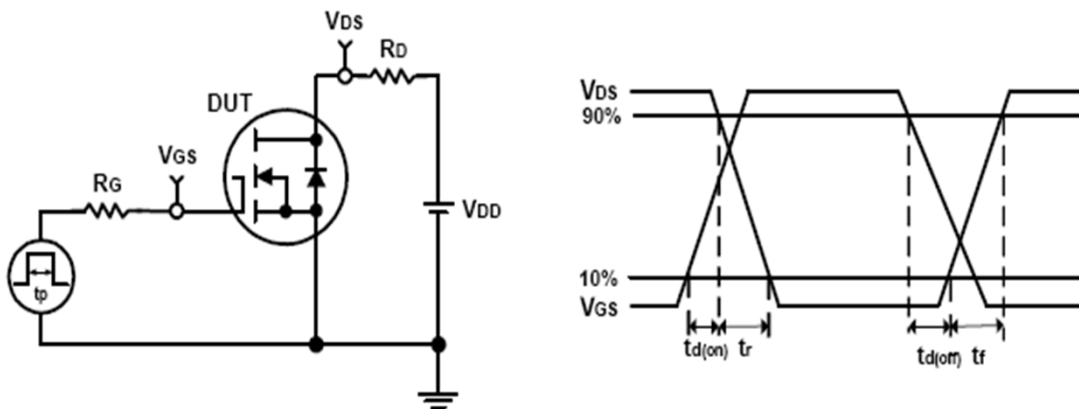

**Package Information**

**SOT23-3**

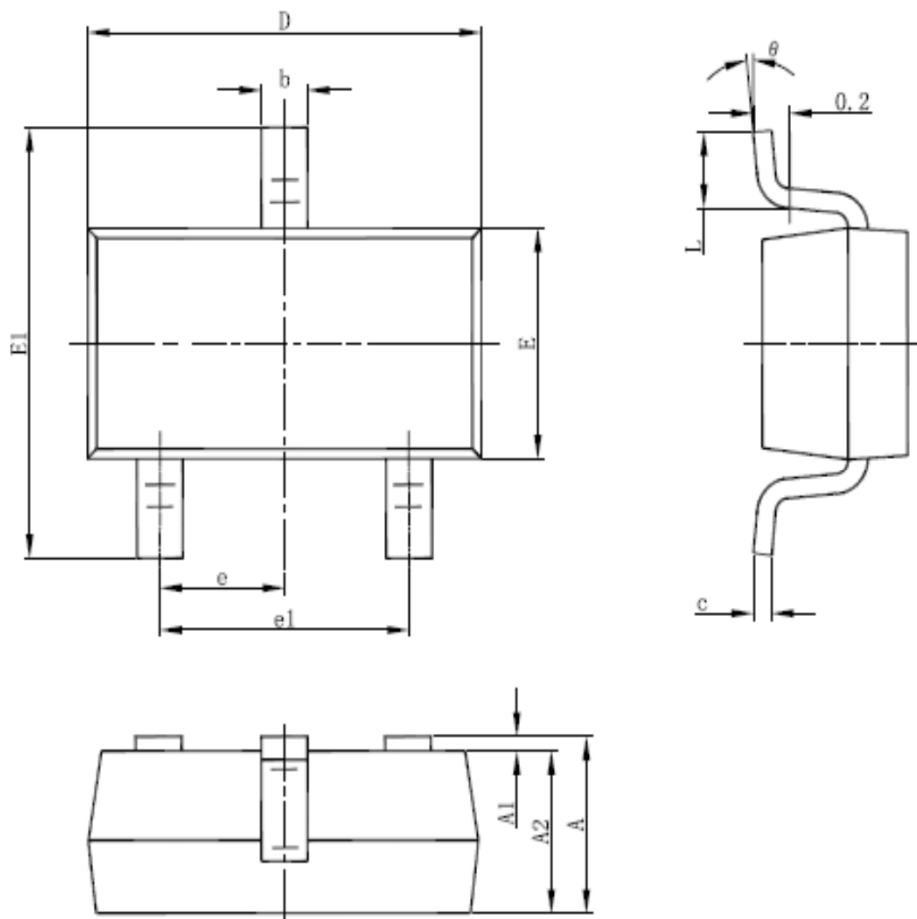

SYMBOL	MM			INCH		
	MIN	NOM	MAX	MIN	NOM	MAX
A	0.950	1.150	1.450	0.037	0.045	0.057
A1	0.000	*	0.150	0.000	*	0.006
A2	0.900	1.100	1.300	0.035	0.043	0.051
b	0.300	0.400	0.500	0.012	0.016	0.020
c	0.080	0.150	0.200	0.003	0.006	0.008
D	2.800	2.925	3.050	0.110	0.115	0.120
E	1.500	1.600	1.750	0.059	0.063	0.069
E1	2.650	2.800	3.000	0.104	0.110	0.118
e	0.950 BSC			0.037 BSC		
e1	1.800	1.900	2.000	0.071	0.075	0.079
L	0.300	0.450	0.600	0.012	0.018	0.024
$\theta$	0°	4°	8°	0°	4°	8°

**Customer Service****Worldwide Sales and Service:**

Sales@ruichips.com

**Technical Support:**

Technical@ruichips.com

**Investor Relations Contacts:**

Investor@ruichips.com

**Marcom Contact:**

Marcom@ruichips.com

**Editorial Contact:**

Editorial@ruichips.com

**HR Contact:**

HR@ruichips.com

**Legal Contact:**

Legal@ruichips.com

**Shen Zhen RUICHIPS Semiconductor CO., LTD**

4th Floor, Block 8, Changyuan New Material Port, Keyuan Middle Road, Science & Industry Park,  
Nanshan District, Shenzhen, CHINA

**TEL:** (86-755) 8311-5334

**FAX:** (86-755) 8311-4278

**E-mail:** Sales-SZ@ruichips.com