

CJAC90SN12 N-Channel Power MOSFET

$V_{(BR)DSS}$	$R_{DS(on)MAX}$	I_D
120V	6.8mΩ@10V	90A

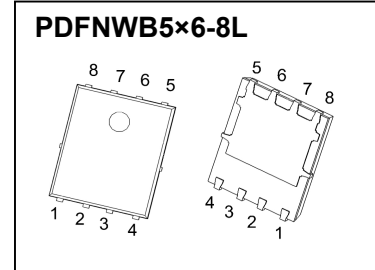

DESCRIPTION

The CJAC90SN12 uses shielded gate trench technology and design to provide excellent $R_{DS(ON)}$ with low gate charge. It can be used in a wide variety of applications

FEATURES

- High Power and current handing capability
- Load switch
- High density cell design for ultra low $R_{DS(ON)}$
- Lead free product is acquired
- Good stability and uniformity with high E_{AS}
- Excellent package for good heat dissipation

APPLICATIONS

- SMPS and general purpose applications
- Hard switched and high frequency circuits
- Uninterruptible Power Supply
- Power management

MARKING



CJAC90SN12 = Part No.
 Solid dot=Pin1 indicator
 XX=Code

EQUIVALENT CIRCUIT

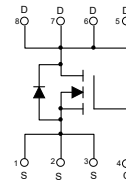

ABSOLUTE MAXIMUM RATINGS ($T_a=25^{\circ}C$ unless otherwise noted)

Parameter	Symbol	Value	Unit
Drain-Source Voltage	V_{DS}	120	V
Gate-Source Voltage	V_{GS}	±20	
Continuous Drain Current	I_D	90	A
Pulsed Drain Current ⁽¹⁾	I_{DM}	360	
Maximum Power Dissipation ⁽²⁾	P_D	2	W
Avalanche energy*	E_{AS}	500	mJ
Thermal Resistance from Junction to Case $T_c=25^{\circ}C$	$R_{\theta JC}$	0.85	$^{\circ}C/W$
Thermal Resistance from Junction to Ambient ⁽³⁾	$R_{\theta JA}$	62.5	$^{\circ}C/W$
Junction Temperature	T_J	150	$^{\circ}C$
Storage Temperature	T_{STG}	-55~ +150	

* E_{AS} test condition $V_{DD}=50V$, $V_{GS}=10V$, $R_G=25\ \Omega$, $L=0.5\ mH$, starting $T_J=25^{\circ}C$.

MOSFET ELECTRICAL CHARACTERISTICS

$T_a=25\text{ }^\circ\text{C}$ unless otherwise specified

Parameter	Symbol	Test Condition	Min	Type	Max	Unit
Static Characteristics						
Drain-source breakdown voltage	$V_{(BR)DSS}$	$V_{GS} = 0V, I_D = 250\mu A$	120			V
Zero gate voltage drain current	I_{DSS}	$V_{DS} = 120V, V_{GS} = 0V$			1	μA
Gate-body leakage current	I_{GSS}	$V_{GS} = \pm 20V, V_{DS} = 0V$			± 100	nA
Gate threshold voltage ⁽¹⁾	$V_{GS(th)}$	$V_{DS} = V_{GS}, I_D = 250\mu A$	2.0	3.0	4.0	V
Drain-source on-resistance ⁽¹⁾	$R_{DS(on)}$	$V_{GS} = 10V, I_D = 20A$		5.4	6.8	m Ω
Gate resistance	R_G			3.2		Ω
Dynamic characteristics⁽⁴⁾						
Total gate charge	Q_g	$V_{DS} = 60V, V_{GS} = 10V, I_D = 20A$		45.2		nC
Gate-source charge	Q_{gs}			13.5		
Gate-drain charge	Q_{gd}			6.7		
Input Capacitance	C_{iss}	$V_{DS} = 60V, V_{GS} = 0V, f = 1MHz$		3670		pF
Output Capacitance	C_{oss}			472		
Reverse Transfer Capacitance	C_{rss}			7.6		
SWITCHING PARAMETERS⁽⁴⁾						
Turn-on delay time	$t_{d(on)}$	$V_{GS} = 10V, V_{DS} = 60V,$ $R_G = 10\Omega, I_D = 20A$		16		ns
Turn-on rise time	t_r			9		
Turn-off delay time	$t_{d(off)}$			27		
Turn-off fall time	t_f			12		
Source-Drain Diode characteristics⁽¹⁾						
Body diode voltage	V_{SD}	$I_S = 10A, V_{GS} = 0V$			1.2	V
Reverse recovery time	T_{rr}	$V_R = 60V, I_F = 20A, di_F/dt = 500 A/\mu s$		50		ns
Reverse recovery charge	Q_{rr}			300		nC

Notes:

1. Pulse Test : Pulse width $\leq 300\mu s$, duty cycle $\leq 0.5\%$.
2. Mounted on a glass epoxy board of 25.4mm x 25.4mm x 0.8mm.
3. The value of $R_{\theta JA}$ is measured with the device mounted on 1 in 2 FR-4 board with 2oz. Copper, in a still air environment with $T_a = 25\text{ }^\circ\text{C}$.
4. Guaranteed by design, not subject to production testing.

Typical Characteristics

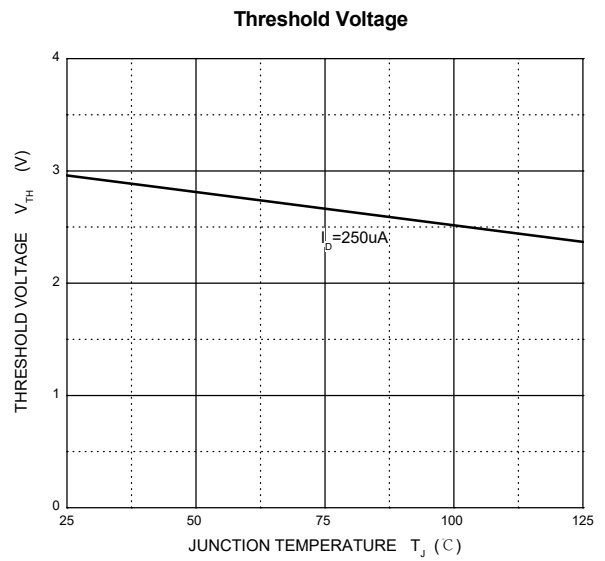
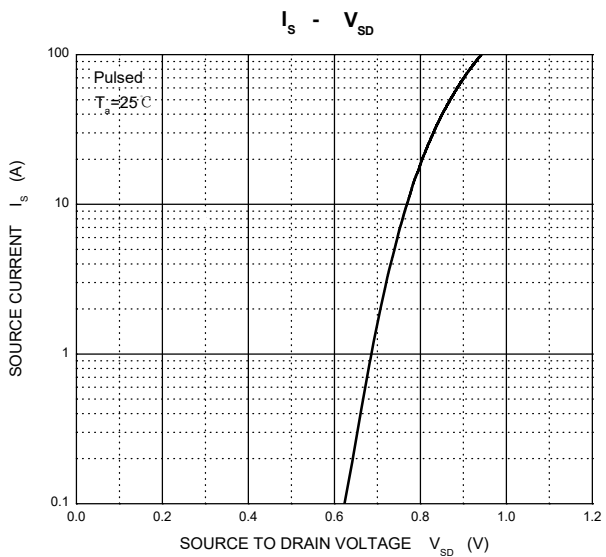
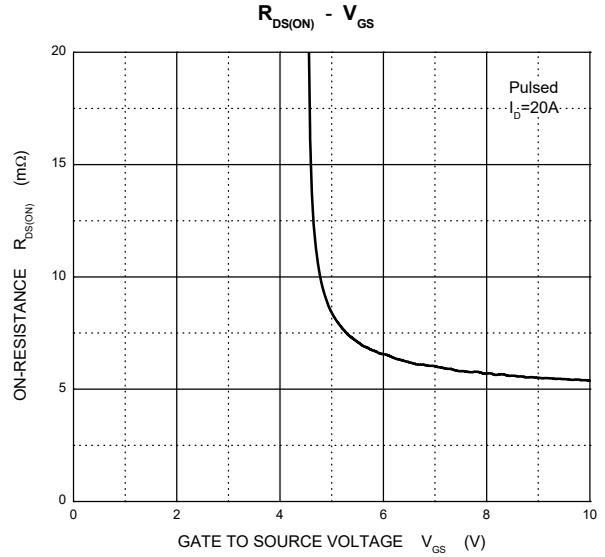
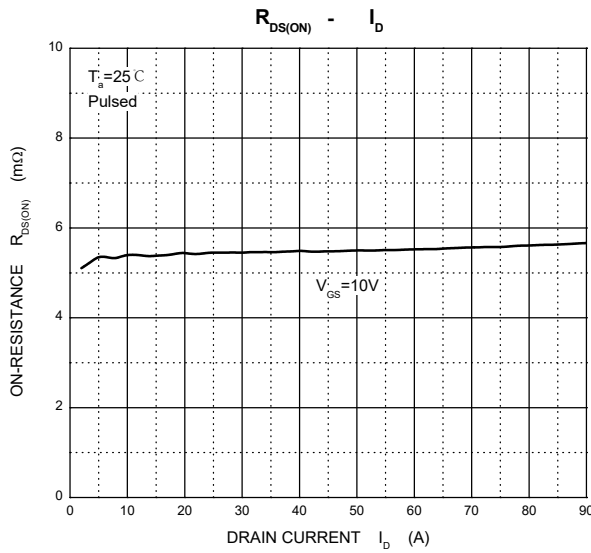
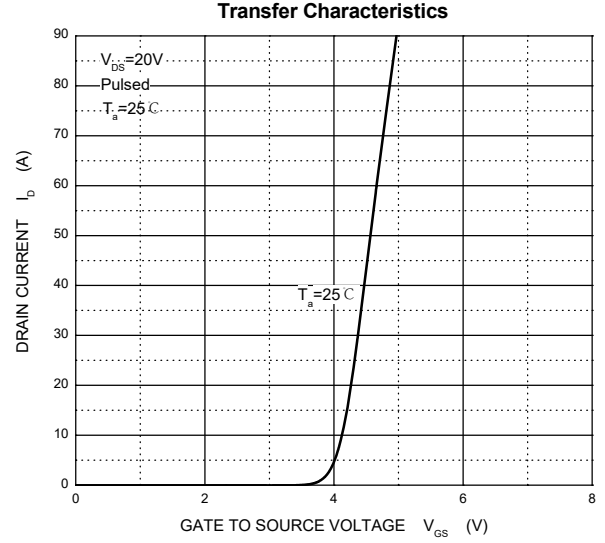
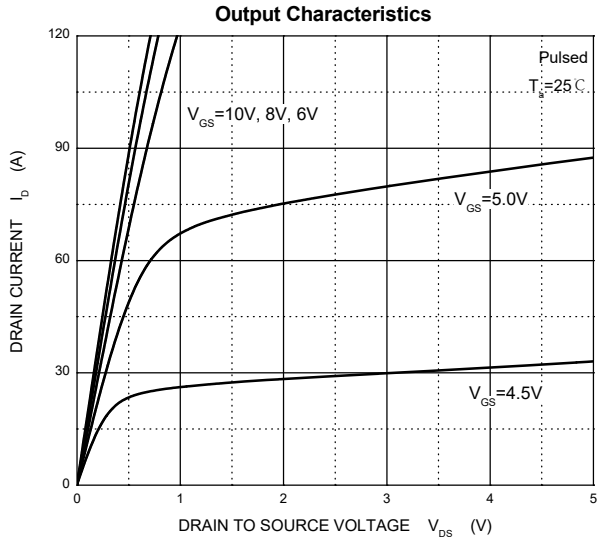

Typical Characteristics

Capacitances

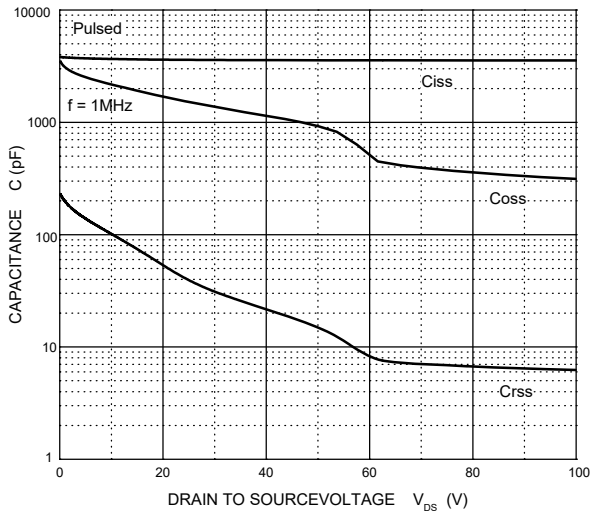

Gate Charge

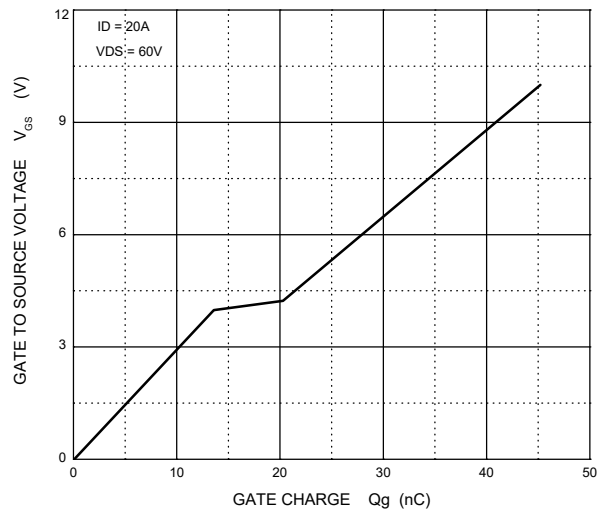

PDFNWB5x6-8L Package Outline Dimensions

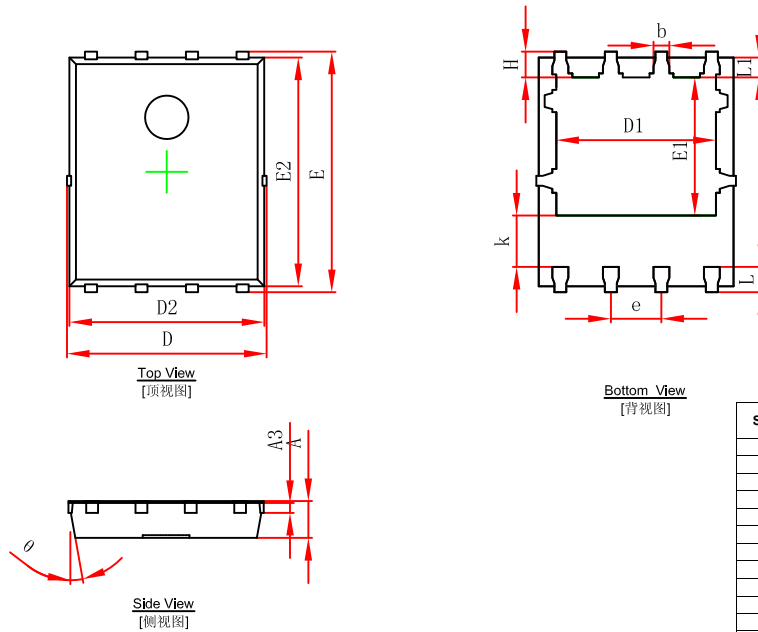

Symbol	Dimensions In Millimeters		Dimensions In Inches	
	Min.	Max.	Min.	Max.
A	0.900	1.000	0.035	0.039
A3	0.254REF.		0.010REF.	
D	4.944	5.096	0.195	0.201
E	5.974	6.126	0.235	0.241
D1	3.910	4.110	0.154	0.162
E1	3.375	3.575	0.133	0.141
D2	4.824	4.976	0.190	0.196
E2	5.674	5.826	0.223	0.229
k	1.190	1.390	0.047	0.055
b	0.350	0.450	0.014	0.018
e	1.270TYP.		0.050TYP.	
L	0.559	0.711	0.022	0.028
L1	0.424	0.576	0.017	0.023
H	0.574	0.726	0.023	0.029
θ	10°	12°	10°	12°

PDFNWB5x6-8L Suggested Pad Layout

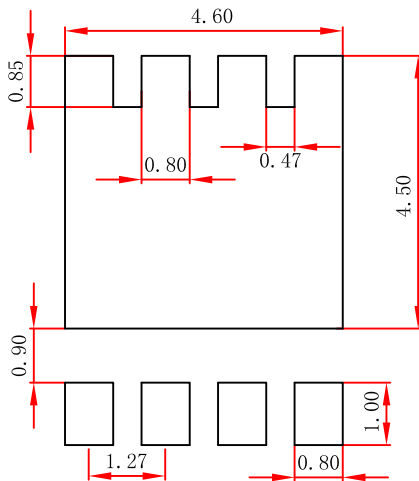

- Note:**
1. Controlling dimension: in millimeters.
 2. General tolerance: $\pm 0.05\text{mm}$.
 3. The pad layout is for reference purposes only.

NOTICE

JSCJ reserves the right to make modifications, enhancements, improvements, corrections or other changes without further notice to any product herein. JSCJ does not assume any liability arising out of the application or use of any product described herein.

PDFNWB5×6 Tape and Reel

PDFNWB5×6-8L Embossed Carrier Tape

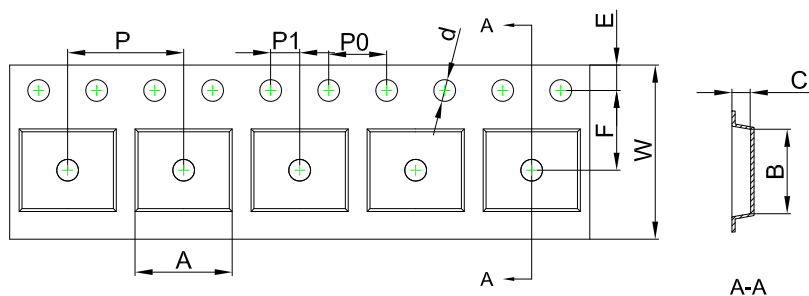

Packaging Description:
PDFNWB5×6-8L parts are shipped in tape. The carrier tape is made from a dissipative (carbon filled) polycarbonate resin. The cover tape is a multilayer film (Heat Activated Adhesive in nature) primarily composed of polyester film, adhesive layer, sealant, and anti-static sprayed agent. These reeled parts in standard option are shipped with 5,000 units per 13" or 33.0 cm diameter reel. The reels are clear in color and is made of polystyrene plastic (anti-static coated).

Dimensions are in millimeter										
Pkg type	A	B	C	d	E	F	P0	P	P1	W
PDFNWB5×6-8L	6.30	5.30	1.10	Ø1.50	1.75	5.50	4.00	8.00	2.00	12.00

PDFNWB5×6-8L Tape Leader and Trailer

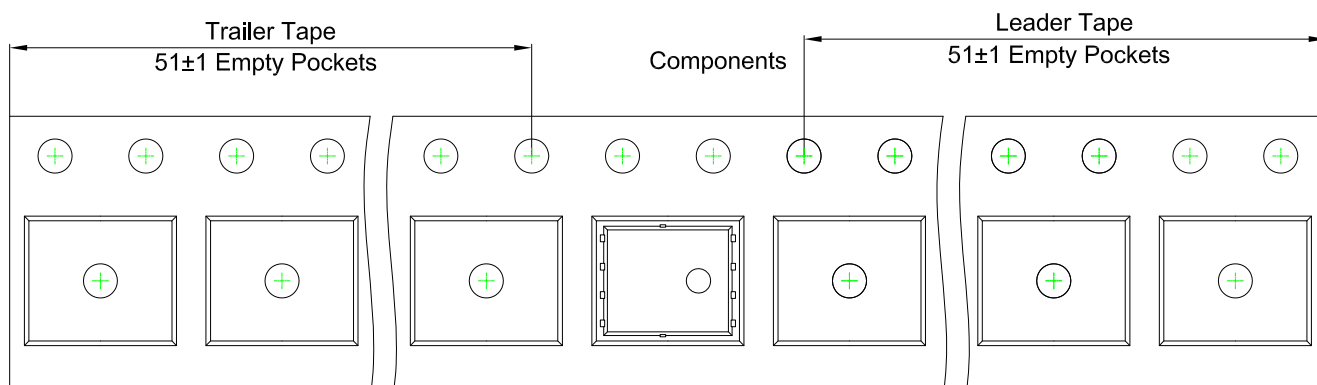

PDFNWB5×6-8L Reel

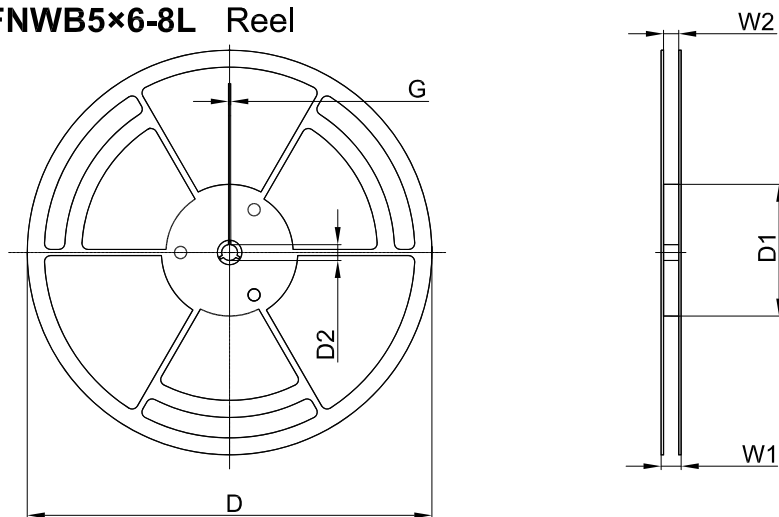

Dimensions are in millimeter						
Reel Option	D	D1	D2	G	W1	W2
13"Dia	Ø330.00	100.00	13.00	1.90	17.60	12.40

REEL	Reel Size	Box	Box Size(mm)	Carton	Carton Size(mm)
5,000 pcs	13 inch	5,000 pcs	340×336×29	50,000 pcs	353×346×365