

CJMNP517 N Channel +P Channel MOSFET

$V_{(BR)DSS}$	$R_{DS(on)MAX}$	I_D
12V	24mΩ@10V	6A
	27mΩ@4.5V	
	42mΩ@2.5V	
	72mΩ@1.8V	
-12V	45mΩ@-4.5V	-4.1A
	60mΩ@-2.5V	
	90mΩ@-1.8V	

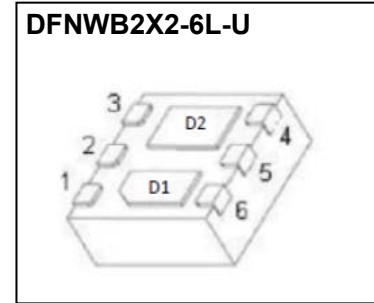

FEATURE

- Surface Mount Package
- Super High Density Cell Design for Extremely Low $R_{DS(ON)}$
- Exceptional On-resistance and Maximum DC Current Capability

APPLICATION

- Power Management In Note Book
- Portable Equipment
- Battery Powered System
- DC/DC Converter
- Load Switch

MARKING:

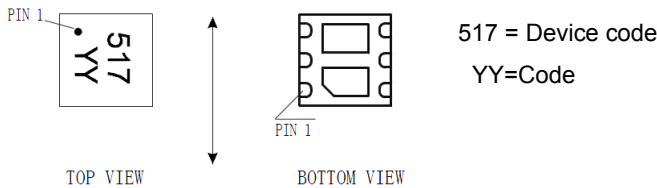

Equivalent Circuit

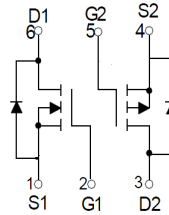

ABSOLUTE MAXIMUM RATINGS ($T_a=25^\circ\text{C}$ unless otherwise noted)

Parameter	Symbol	Value	Unit
N-MOSFET			
Drain-Source Voltage	V_{DS}	12	V
Gate-Source Voltage	V_{GS}	± 12	V
Continuous Drain Current (note 1)	I_D	6	A
Pulsed Drain Current ($t_p=10\mu\text{s}$)	I_{DM}	24	A
Continous Source-Drain Diode Current	I_S	6	A
P-MOSFET			
Drain-Source Voltage	V_{DS}	-12	V
Gate-Source Voltage	V_{GS}	± 12	V
Continuous Drain Current (note 1)	I_D	-4.1	A
Pulsed Drain Current ($t_p=10\mu\text{s}$)	I_{DM}	-16.4	A
Continous Source-Drain Diode Current	I_S	-4.1	A
Temperature and Thermal Resistance			
Thermal Resistance from Junction to Ambient (note 1)	$R_{\theta JA}$	167	$^\circ\text{C/W}$
Junction Temperature	T_J	150	$^\circ\text{C}$
Storage Temperature	T_{STG}	-55~+150	$^\circ\text{C}$
Lead Temperature for Soldering Purposes(1/8" from case for 10 s)	T_L	260	$^\circ\text{C}$

MOSFET ELECTRICAL CHARACTERISTICS

N-ch MOSFET ELECTRICAL CHARACTERISTICS($T_a=25^\circ\text{C}$ unless otherwise noted)

Parameter	Symbol	Test Condition	Min	Typ	Max	Unit
STATIC CHARACTERISTICS						
Drain-source breakdown voltage	$V_{(BR)DSS}$	$V_{GS} = 0V, I_D = 250\mu A$	12			V
Zero gate voltage drain current	I_{DSS}	$V_{DS} = 16V, V_{GS} = 0V$			1	μA
Gate-body leakage current	I_{GSS}	$V_{GS} = \pm 12V, V_{DS} = 0V$			± 100	nA
Gate threshold voltage (note 2)	$V_{GS(th)}$	$V_{DS} = V_{GS}, I_D = 250\mu A$	0.5		1	V
Drain-source on-resistance(note 2)	$R_{DS(on)}$	$V_{GS} = 10V, I_D = 6A$		18	24	$m\Omega$
		$V_{GS} = 4.5V, I_D = 5A$		21	27	$m\Omega$
		$V_{GS} = 2.5V, I_D = 4A$		27	42	$m\Omega$
		$V_{GS} = 1.8V, I_D = 2A$		44	74	$m\Omega$
Forward tranconductance(note 2)	g_{FS}	$V_{DS} = 5V, I_D = 3.8A$	4			S
Diode forward voltage	V_{SD}	$I_S = 1A, V_{GS} = 0V$			1	V
DYNAMIC CHARACTERISTICS (note 4)						
Input Capacitance	C_{iss}	$V_{DS} = 10V, V_{GS} = 0V, f = 1MHz$		630		pF
Output Capacitance	C_{oss}			164		pF
Reverse Transfer Capacitance	C_{rss}			137		pF
SWITCHING CHARACTERISTICS (note 3,4)						
Turn-on delay time	$t_{d(on)}$	$V_{GS} = 5V, V_{DS} = 10V,$ $R_{GEN} = 6\Omega, R_L = 1.7\Omega$		5.5		ns
Turn-on rise time	t_r			14		ns
Turn-off delay time	$t_{d(off)}$			29		ns
Turn-off fall time	t_f			10.2		ns
Total Gate Charge	Q_g	$V_{DS} = 10V, I_D = 6A,$ $V_{GS} = 10V$		12		nC
Gate-Source Charge	Q_{gs}			1		nC
Gate-Drain Charge	Q_{gd}			2		nC

P-ch MOSFET ELECTRICAL CHARACTERISTICS($T_a=25^\circ\text{C}$ unless otherwise noted)

Parameter	Symbol	Test Condition	Min	Typ	Max	Unit
STATIC CHARACTERISTICS						
Drain-source breakdown voltage	$V_{(BR)DSS}$	$V_{GS} = 0V, I_D = -250\mu A$	-12			V
Zero gate voltage drain current	I_{DSS}	$V_{DS} = -8V, V_{GS} = 0V$			-1	μA
Gate-body leakage current	I_{GSS}	$V_{GS} = \pm 8V, V_{DS} = 0V$			± 100	nA
Gate threshold voltage (note 2)	$V_{GS(th)}$	$V_{DS} = V_{GS}, I_D = -250\mu A$	-0.5		-0.9	V
Drain-source on-resistance(note 2)	$R_{DS(on)}$	$V_{GS} = -4.5V, I_D = -3.5A$			45	$m\Omega$
		$V_{GS} = -2.5V, I_D = -3A$			60	$m\Omega$
		$V_{GS} = -1.8V, I_D = -2A$			90	$m\Omega$
Forward tranconductance(note 2)	g_{FS}	$V_{DS} = -5V, I_D = -4.1A$	6			S
Diode forward voltage	V_{SD}	$I_S = -3.3A, V_{GS} = 0V$			-1.2	V
DYNAMIC CHARACTERISTICS (note 4)						
Input Capacitance	C_{iss}	$V_{DS} = -4V, V_{GS} = 0V, f = 1MHz$		740		pF
Output Capacitance	C_{oss}			290		pF
Reverse Transfer Capacitance	C_{rss}			190		pF
SWITCHING CHARACTERISTICS (note 3,4)						
Turn-on delay time	$t_{d(on)}$	$V_{GEN} = -4.5V, V_{DD} = -4V,$ $I_D = -3.3A, R_G = 1\Omega,$ $R_L = 1.2\Omega$			20	ns
Turn-on rise time	t_r				53	ns
Turn-off delay time	$t_{d(off)}$				48	ns
Turn-off fall time	t_f				20	ns
Total Gate Charge	Q_g	$V_{DS} = -4V, I_D = -4.1A,$ $V_{GS} = -2.5V$			9	nC
Gate-Source Charge	Q_{gs}			1.2		nC
Gate-Drain Charge	Q_{gd}			1.6		nC

Notes :

1. Surface mounted on FR4 board using the minimum recommended pad size.
2. Pulse Test : Pulse width=300 μs , duty cycle $\leq 2\%$.
3. Switching characteristics are independent of operating junction temperature.
4. Guaranteed by design, not subject to producing.

Typical Characteristics

N-Channel MOS

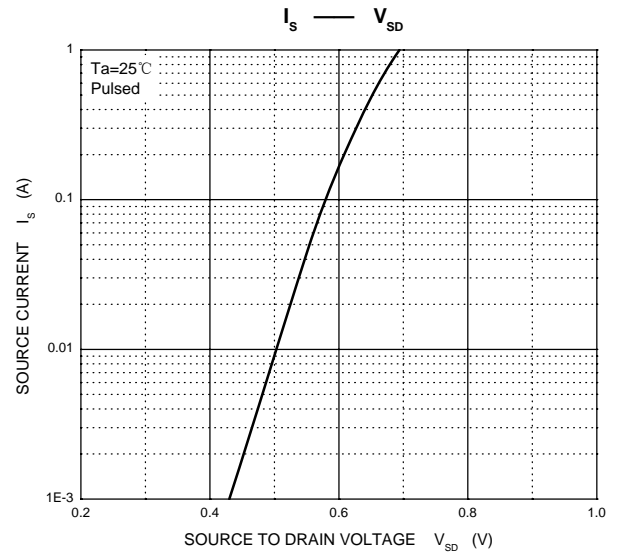
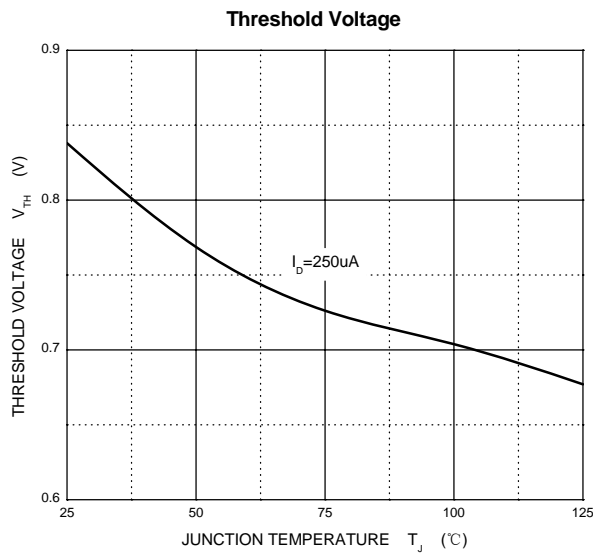
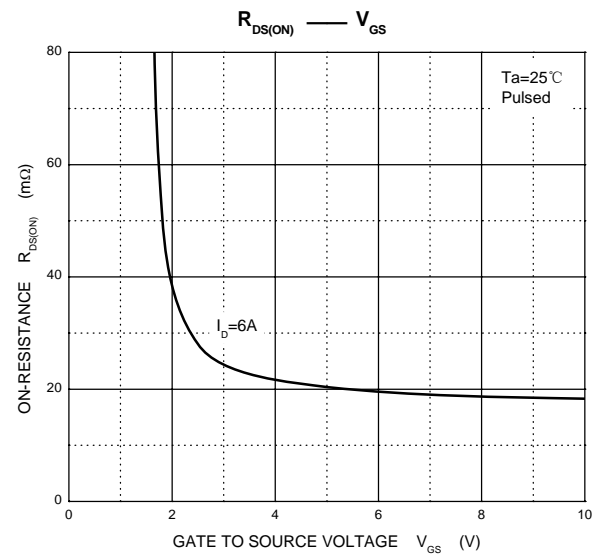
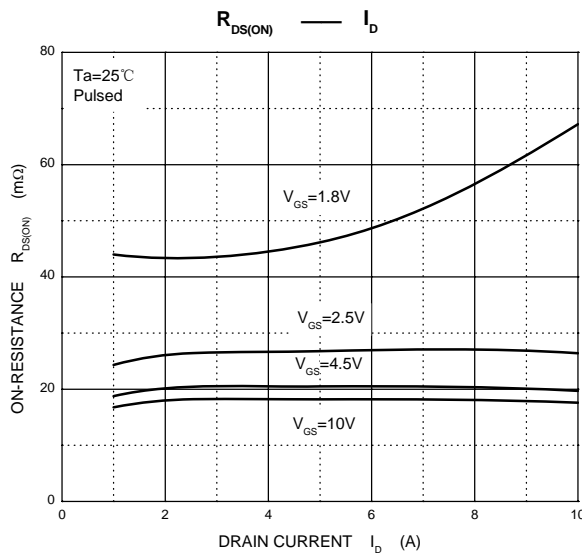
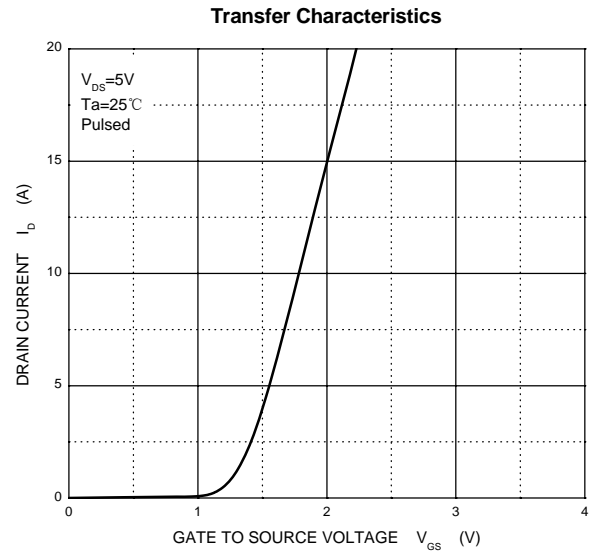
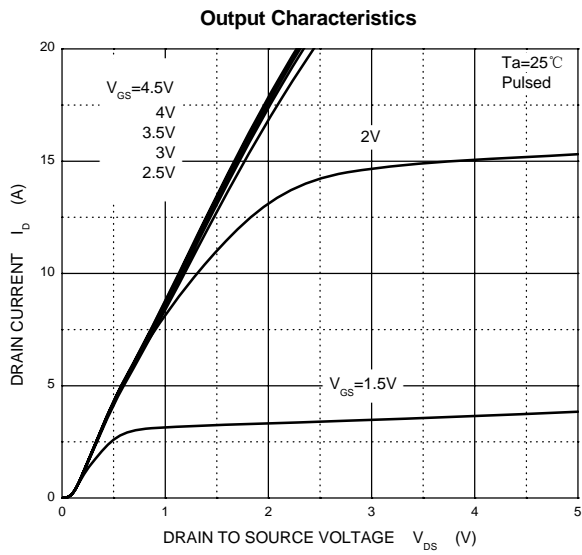

Typical Characteristics

P-Channel MOS

Output Characteristics

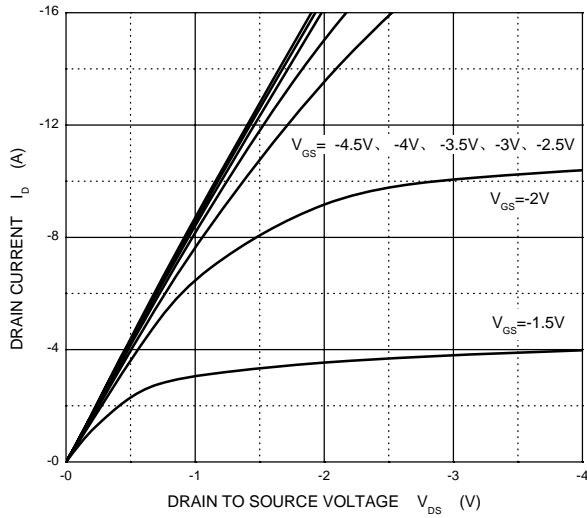

Transfer Characteristics

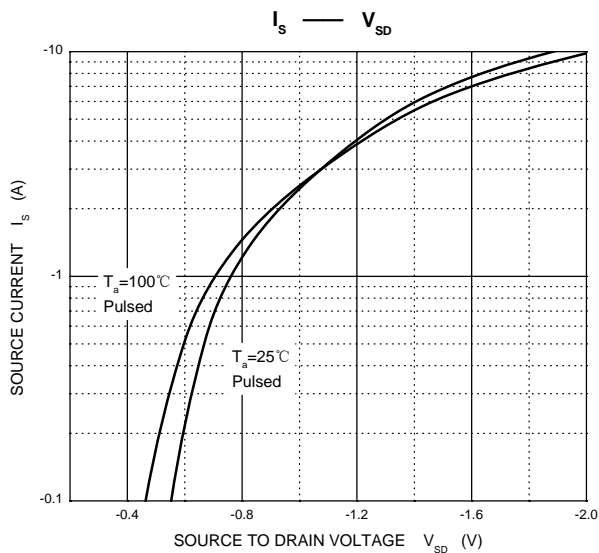
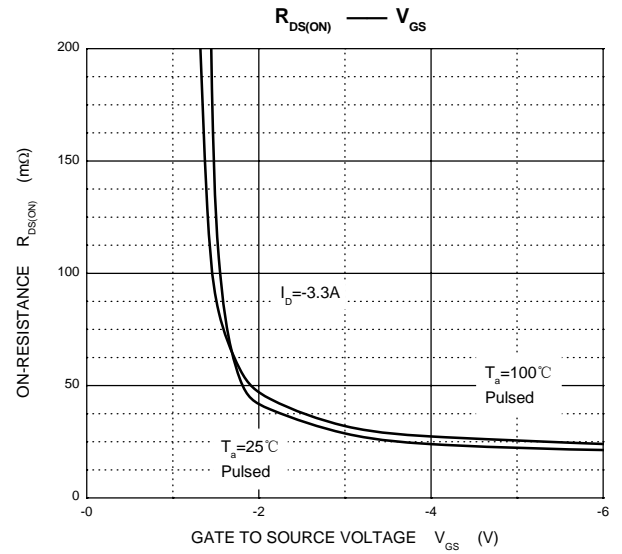
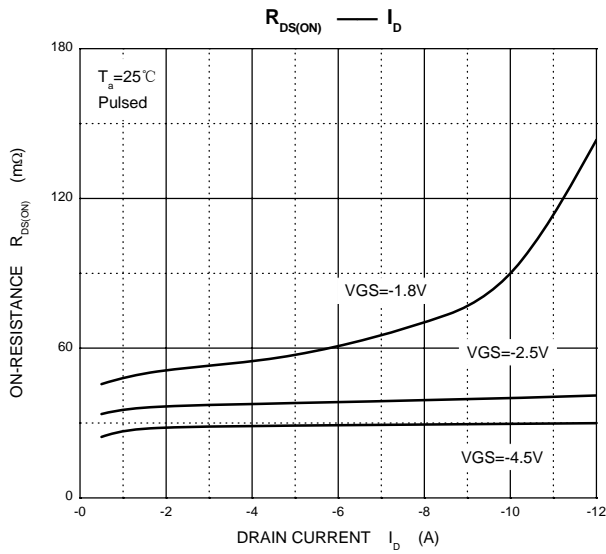
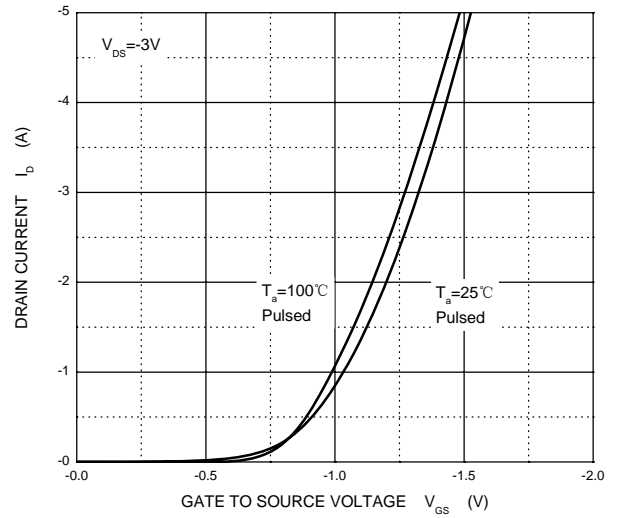

Threshold Voltage

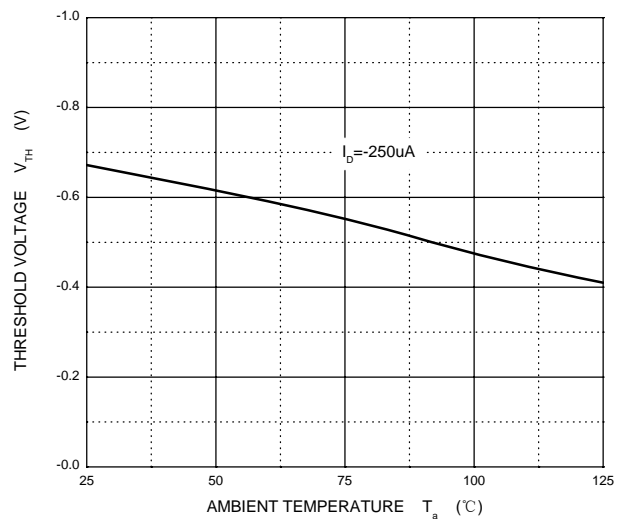

DFNWB2X2-6L-U Package Outline Dimensions

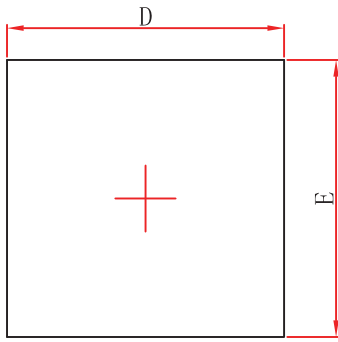

Top View

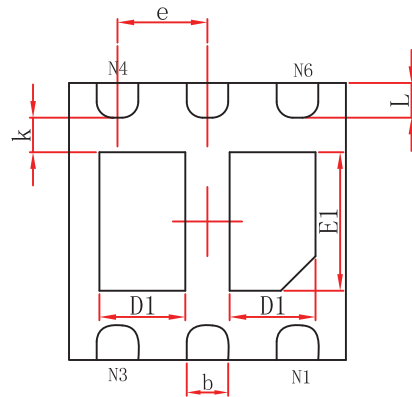

Bottom View

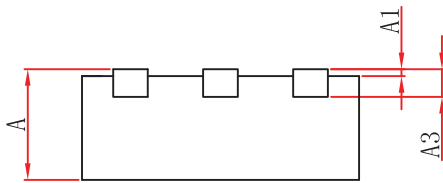

Side View

Symbol	Dimensions In Millimeters		Dimensions In Inches	
	Min.	Max.	Min.	Max.
A	0.700/0.800	0.800/0.900	0.028/0.031	0.031/0.035
A1	0.000	0.050	0.000	0.002
A3	0.203REF.		0.008REF.	
D	1.924	2.076	0.076	0.082
E	1.924	2.076	0.076	0.082
D1	0.520	0.720	0.020	0.028
E1	0.900	1.100	0.035	0.043
k	0.200MIN.		0.008MIN.	
b	0.250	0.350	0.010	0.014
e	0.650TYP.		0.026TYP.	
L	0.174	0.326	0.007	0.013

NOTICE

JSCJ reserves the right to make modifications, enhancements, improvements, corrections or other changes without further notice to any product herein. JSCJ does not assume any liability arising out of the application or use of any product described herein.

DFNWB2X2-6L-U Tape and Reel

DFNWB2×2-6L Embossed Carrier Tape

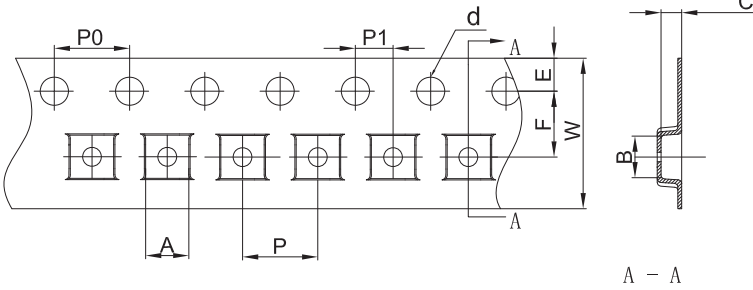

Packaging Description:
 DFNWB2×2-6L parts are shipped in tape. The carrier tape is made from a dissipative (carbon filled) polycarbonate resin. The cover tape is a multilayer film (Heat Activated Adhesive in nature) primarily composed of polyester film, adhesive layer, sealant, and anti-static sprayed agent. These reeled parts in standard option are shipped with 3,000 units per 7" or 17.8cm diameter reel. The reels are clear in color and is made of polystyrene plastic (anti-static coated).

Dimensions are in millimeter										
Pkg type	A	B	C	d	E	F	P0	P	P1	W
DFNWB2×2-6L	2.30	2.30	1.10	Ø1.50	1.75	3.50	4.00	4.00	2.00	8.00
(Tolerance)	+/-0.05	+/-0.05	+/-0.05	+/-0.1	+/-0.1	+/-0.1	+/-0.1	+/-0.1	+/-0.1	+0.3/-0.1

DFNWB2×2-6L Tape Leader and Trailer

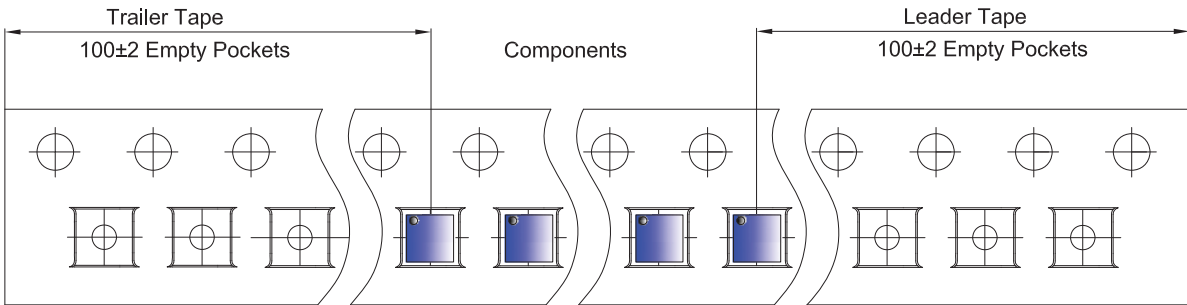

DFNWB2×2-6L Reel

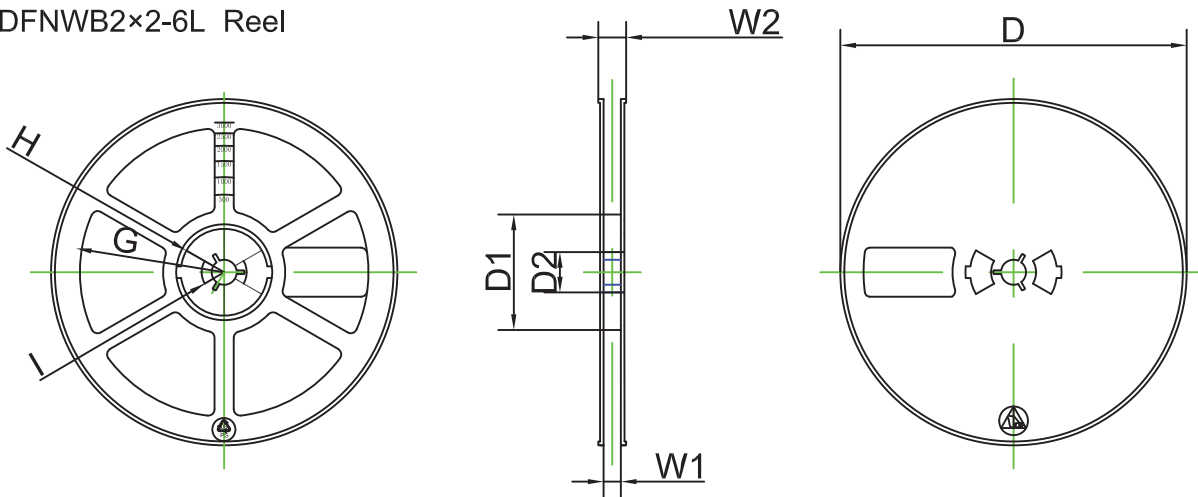

Dimensions are in millimeter								
Reel Option	D	D1	D2	G	H	I	W1	W2
7" Dia	Ø180.00	60.00	13.00	R78.00	R25.60	R11.50	9.50	13.10
Tolerance	+0/-3	+/-0.5	+/-0.2	+/-1	+/-1	+/-1	+/-1	+/-1.3

REEL	Reel Size	Box	Box Size(mm)	Carton	Carton Size(mm)	G.W.(kg)
3000 pcs	7 inch	30,000 pcs	203×203×195	120,000 pcs	438×438×220	