

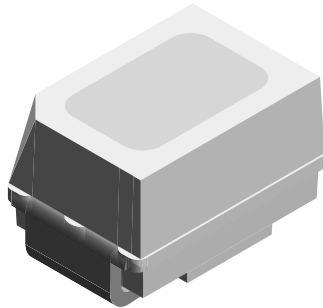

Power Mini SMD LED



19226

DESCRIPTION

The new MiniLED series has been designed in a small white SMT package. The feature of the device is the very small package 2.3 mm x 1.3 mm x 1.4 mm. The MiniLED is an obvious solution for small-scale, high-power products that are expected to work reliably in an arduous environment. This is often the case in automotive and industrial application.

PRODUCT GROUP AND PACKAGE DATA

- Product group: LED
- Product series: power
- Package: SMD MiniLED
- Angle of half intensity: $\pm 60^\circ$

FEATURES

- Utilizing latest advanced AlInGaP technology
- Available in 8 mm tape
- Luminous intensity and color categorized per packing unit
- Luminous intensity ratio per packing unit $I_{Vmax}/I_{Vmin.} \leq 1.6$
- ESD-withstand voltage: up to 2 kV according to JESD22-A114-B
- Preconditioning according to JEDEC® level 2a
- IR reflow soldering
- AEC-Q101 qualified
- Material categorization: for definitions of compliance please see www.vishay.com/doc?99912



APPLICATIONS

- Traffic signals and signs
- Interior and exterior lighting
- Dashboard illumination
- Indicator and backlighting purposes for audio, video, LCDs switches, symbols, illuminated advertising etc.

| PARTS TABLE | | | | | | | | | | | | | | |
|-------------------|-------------|--------------------------|------|------|------------------------|-----------------|------|------|------------------------|---------------------|------|------|------------------------|---------------|
| PART | COLOR | LUMINOUS INTENSITY (mcd) | | | at I _F (mA) | WAVELENGTH (nm) | | | at I _F (mA) | FORWARD VOLTAGE (V) | | | at I _F (mA) | TECHNOLOGY |
| | | MIN. | TYP. | MAX. | | MIN. | TYP. | MAX. | | MIN. | TYP. | MAX. | | |
| VLMS233T1V1-GS08 | Super red | 280 | 450 | 900 | 20 | 626 | 630 | 639 | 20 | 1.8 | 2.0 | 2.6 | 20 | AllnGaP on Si |
| VLMR233T2V2-GS08 | Red | 355 | 650 | 1120 | 20 | 619 | 625 | 631 | 20 | 1.8 | 2.0 | 2.6 | 20 | AllnGaP on Si |
| VLMK233U1AA-GS08 | Amber | 450 | 680 | 1400 | 20 | 611 | 616 | 622 | 20 | 1.8 | 2.1 | 2.6 | 20 | AllnGaP on Si |
| VLMO233U1AA-GS08 | Soft orange | 450 | 760 | 1400 | 20 | 600 | 605 | 611 | 20 | 1.8 | 2.1 | 2.6 | 20 | AllnGaP on Si |
| VLMO233U2V2-35-08 | Soft orange | 560 | 760 | 1120 | 20 | 602 | 605 | 609 | 20 | 1.8 | 2.1 | 2.6 | 20 | AllnGaP on Si |
| VLMY233T2V2-GS08 | Yellow | 355 | 650 | 1120 | 20 | 583 | 589 | 594 | 20 | 1.8 | 2.15 | 2.6 | 20 | AllnGaP on Si |

| ABSOLUTE MAXIMUM RATINGS (T _{amb} = 25 °C, unless otherwise specified) VLMS233.., VLMR233.., VLMK233.., VLMO233.., VLMY233.. | | | | |
|--|--|-------------------|-------------|------|
| PARAMETER | TEST CONDITION | SYMBOL | VALUE | UNIT |
| Reverse voltage ⁽¹⁾ | Short term application only | V _R | 5 | V |
| DC Forward current | T _{amb} ≤ 60 °C (480 K/W) | I _F | 50 | mA |
| Power dissipation | | P _V | 130 | mW |
| Junction temperature | | T _j | 125 | °C |
| Operating temperature range | | T _{amb} | -40 to +100 | °C |
| Storage temperature range | | T _{stg} | -40 to +100 | °C |
| Thermal resistance junction/ambient | Mounted on PC board (pad size > 16 mm ²) | R _{thJA} | 480 | K/W |

Note

⁽¹⁾ Driving the LED in reverse direction is suitable for a short term application only



| OPTICAL AND ELECTRICAL CHARACTERISTICS ($T_{amb} = 25\text{ }^{\circ}\text{C}$, unless otherwise specified) | | | | | | | |
|--|----------------------|-------------|-----------------|------|----------|------|---------------|
| VLMS233.., SUPER RED | | | | | | | |
| PARAMETER | TEST CONDITION | PART | SYMBOL | MIN. | TYP. | MAX. | UNIT |
| Luminous intensity | $I_F = 20\text{ mA}$ | VLMS233T1V1 | I_V | 280 | 450 | 900 | mcd |
| Luminous flux/luminous intensity | | | ϕ_V/I_V | - | 3 | - | mlm/mcd |
| Dominant wavelength | $I_F = 20\text{ mA}$ | | λ_d | 626 | 630 | 639 | nm |
| Peak wavelength | $I_F = 20\text{ mA}$ | | λ_p | - | 639 | - | nm |
| Spectral bandwidth at 50 % $I_{rel\ max.}$ | $I_F = 20\text{ mA}$ | | $\Delta\lambda$ | - | 18 | - | nm |
| Angle of half intensity | $I_F = 20\text{ mA}$ | | ϕ | - | ± 60 | - | deg |
| Forward voltage | $I_F = 20\text{ mA}$ | | V_F | 1.8 | 2 | 2.6 | V |
| Reverse current | $V_R = 5\text{ V}$ | | I_R | - | 0.01 | 10 | μA |

| OPTICAL AND ELECTRICAL CHARACTERISTICS ($T_{amb} = 25\text{ }^{\circ}\text{C}$, unless otherwise specified) | | | | | | | |
|--|----------------------|-------------|-----------------|------|----------|------|---------------|
| VLMR233.., RED | | | | | | | |
| PARAMETER | TEST CONDITION | PART | SYMBOL | MIN. | TYP. | MAX. | UNIT |
| Luminous intensity | $I_F = 20\text{ mA}$ | VLMR233T2V2 | I_V | 355 | 650 | 1120 | mcd |
| Luminous flux/luminous intensity | | | ϕ_V/I_V | - | 3 | - | mlm/mcd |
| Dominant wavelength | $I_F = 20\text{ mA}$ | | λ_d | 619 | 625 | 631 | nm |
| Peak wavelength | $I_F = 20\text{ mA}$ | | λ_p | - | 632 | - | nm |
| Spectral bandwidth at 50 % $I_{rel\ max.}$ | $I_F = 20\text{ mA}$ | | $\Delta\lambda$ | - | 18 | - | nm |
| Angle of half intensity | $I_F = 20\text{ mA}$ | | ϕ | - | ± 60 | - | deg |
| Forward voltage | $I_F = 20\text{ mA}$ | | V_F | 1.8 | 2 | 2.6 | V |
| Reverse current | $V_R = 5\text{ V}$ | | I_R | - | 0.01 | 10 | μA |

| OPTICAL AND ELECTRICAL CHARACTERISTICS ($T_{amb} = 25\text{ }^{\circ}\text{C}$, unless otherwise specified) | | | | | | | |
|--|----------------------|-------------|-----------------|------|----------|------|---------------|
| VLMK233.., AMBER | | | | | | | |
| PARAMETER | TEST CONDITION | PART | SYMBOL | MIN. | TYP. | MAX. | UNIT |
| Luminous intensity | $I_F = 20\text{ mA}$ | VLMK233U1AA | I_V | 450 | 680 | 1400 | mcd |
| Luminous flux/luminous intensity | | | ϕ_V/I_V | - | 3 | - | mlm/mcd |
| Dominant wavelength | $I_F = 20\text{ mA}$ | | λ_d | 611 | 616 | 622 | nm |
| Peak wavelength | $I_F = 20\text{ mA}$ | | λ_p | - | 622 | - | nm |
| Spectral bandwidth at 50 % $I_{rel\ max.}$ | $I_F = 20\text{ mA}$ | | $\Delta\lambda$ | - | 18 | - | nm |
| Angle of half intensity | $I_F = 20\text{ mA}$ | | ϕ | - | ± 60 | - | deg |
| Forward voltage | $I_F = 20\text{ mA}$ | | V_F | 1.8 | 2.1 | 2.6 | V |
| Reverse current | $V_R = 5\text{ V}$ | | I_R | - | 0.01 | 10 | μA |

| OPTICAL AND ELECTRICAL CHARACTERISTICS ($T_{amb} = 25\text{ }^{\circ}\text{C}$, unless otherwise specified) | | | | | | | |
|--|----------------------|----------------|-----------------|------|----------|------|---------------|
| VLMO233.., SOFT ORANGE | | | | | | | |
| PARAMETER | TEST CONDITION | PART | SYMBOL | MIN. | TYP. | MAX. | UNIT |
| Luminous intensity | $I_F = 20\text{ mA}$ | VLMO233U1AA | I_V | 450 | 760 | 1400 | mcd |
| | | VLMO233U2V2-35 | | 560 | 760 | 1120 | |
| Luminous flux/luminous intensity | | | ϕ_V/I_V | - | 3 | - | mlm/mcd |
| Dominant wavelength | $I_F = 20\text{ mA}$ | VLMO233U1AA | λ_d | 600 | 605 | 611 | nm |
| | | VLMO233U2V2-35 | | 602 | 605 | 609 | nm |
| Peak wavelength | $I_F = 20\text{ mA}$ | | λ_p | - | 611 | - | nm |
| Spectral bandwidth at 50 % $I_{rel\ max.}$ | $I_F = 20\text{ mA}$ | | $\Delta\lambda$ | - | 17 | - | nm |
| Angle of half intensity | $I_F = 20\text{ mA}$ | | ϕ | - | ± 60 | - | deg |
| Forward voltage | $I_F = 20\text{ mA}$ | | V_F | 1.8 | 2.1 | 2.6 | V |
| Reverse current | $V_R = 5\text{ V}$ | | I_R | - | 0.01 | 10 | μA |



OPTICAL AND ELECTRICAL CHARACTERISTICS ($T_{amb} = 25\text{ }^{\circ}\text{C}$, unless otherwise specified)
VLMY233.., YELLOW

| PARAMETER | TEST CONDITION | PART | SYMBOL | MIN. | TYP. | MAX. | UNIT |
|--|----------------------|-------------|-----------------|------|----------|------|---------------|
| Luminous intensity | $I_F = 20\text{ mA}$ | VLMY233T2V2 | I_V | 355 | 650 | 1120 | mcd |
| Luminous flux/luminous intensity | | | ϕ_V/I_V | - | 3 | - | mlm/mcd |
| Dominant wavelength | $I_F = 20\text{ mA}$ | | λ_d | 583 | 589 | 594 | nm |
| Peak wavelength | $I_F = 20\text{ mA}$ | | λ_p | - | 591 | - | nm |
| Spectral bandwidth at 50 % $I_{rel\ max.}$ | $I_F = 20\text{ mA}$ | | $\Delta\lambda$ | - | 17 | - | nm |
| Angle of half intensity | $I_F = 20\text{ mA}$ | | ϕ | - | ± 60 | - | deg |
| Forward voltage | $I_F = 20\text{ mA}$ | | V_F | 1.8 | 2.15 | 2.6 | V |
| Reverse current | $V_R = 5\text{ V}$ | | I_R | - | 0.01 | 10 | μA |

COLOR CLASSIFICATION

| GROUP | DOMINANT WAVELENGTH (nm) | | | | | |
|-------|--------------------------|------|-------------|------|--------|------|
| | AMBER | | SOFT ORANGE | | YELLOW | |
| | MIN. | MAX. | MIN. | MAX. | MIN. | MAX. |
| 1 | 611 | 618 | | | | |
| 2 | 614 | 622 | 600 | 603 | 583 | 586 |
| 3 | | | 602 | 605 | 585 | 588 |
| 4 | | | 604 | 607 | 587 | 590 |
| 5 | | | 606 | 609 | 589 | 592 |
| 6 | | | 608 | 611 | 591 | 594 |

Note

- Wavelengths are tested at a current pulse duration of 25 ms

LUMINOUS INTENSITY CLASSIFICATION

| GROUP | LUMINOUS INTENSITY (mcd) | | |
|-------|--------------------------|----------|------|
| | STANDARD | OPTIONAL | MAX. |
| T | 1 | 280 | 355 |
| | 2 | 355 | 450 |
| U | 1 | 450 | 560 |
| | 2 | 560 | 710 |
| V | 1 | 710 | 900 |
| | 2 | 900 | 1120 |
| A | A | 1120 | 1400 |
| | B | 1400 | 1800 |

Note

- Luminous intensity is tested at a current pulse duration of 25 ms and an accuracy of $\pm 11\%$.
 The above type numbers represent the order groups which include only a few brightness groups. Only one group will be shipped on each reel (there will be no mixing of two groups on each reel).
 In order to ensure availability, single brightness groups will not be orderable.
 In a similar manner for colors where wavelength groups are measured and binned, single wavelength groups will be shipped on any one reel.
 In order to ensure availability, single wavelength groups will not be orderable

CROSSING TABLE

| VISHAY | OSRAM |
|----------------|-----------------|
| VLMS233T1V1 | LS M67F-S2U2-1 |
| VLMO233U2V2-35 | LO M67F-U2AB-24 |
| VLMY233T2V2 | LY M67F-T2V2-36 |



TYPICAL CHARACTERISTICS (T_{amb} = 25 °C, unless otherwise specified)



Fig. 1 - Maximum Permissible Forward Current vs. Ambient Temperature

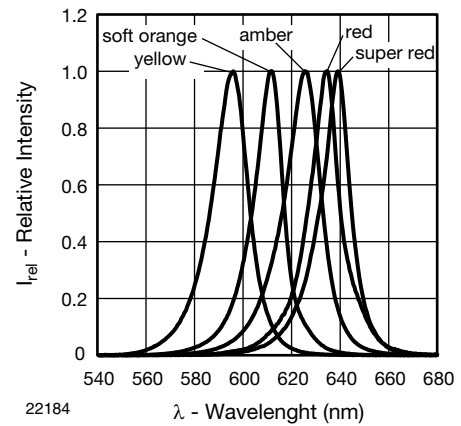

Fig. 4 - Relative Intensity vs. Wavelength

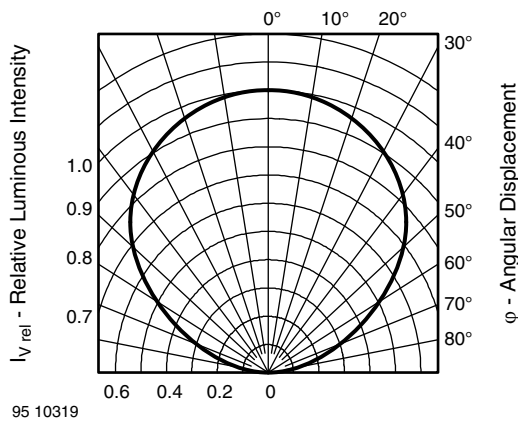

Fig. 2 - Relative Luminous Intensity vs. Angular Displacement

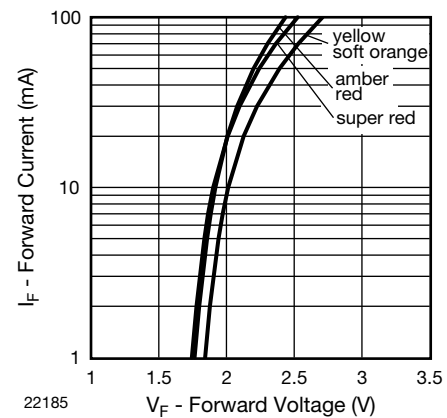

Fig. 5 - Forward Current vs. Forward Voltage



Fig. 3 - Forward Current vs. Pulse Length

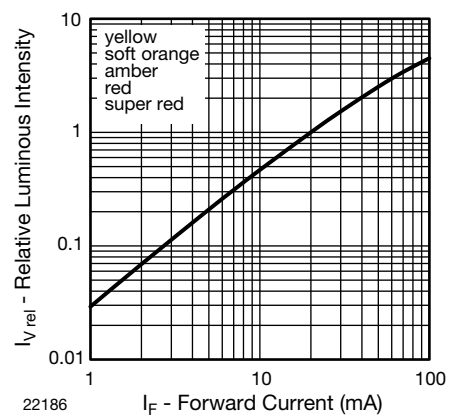

Fig. 6 - Relative Luminous Intensity vs. Forward Current

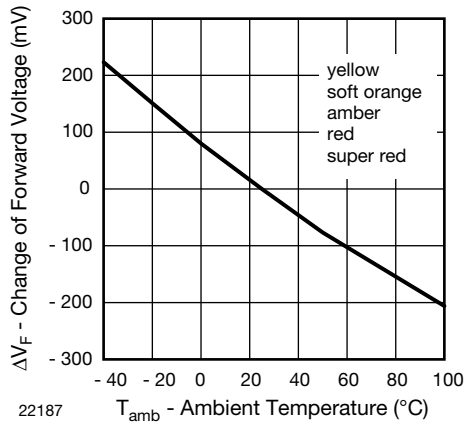

Fig. 7 - Change of Forward Voltage vs. Ambient Temperature

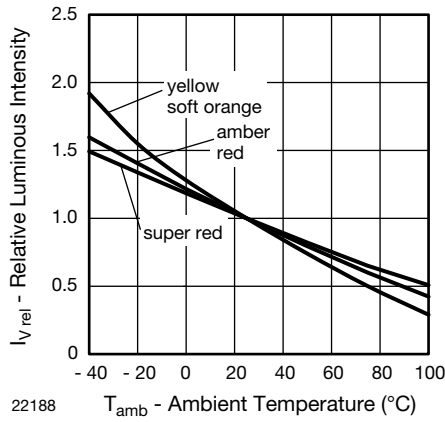

Fig. 8 - Relative Luminous Intensity vs. Ambient Temperature

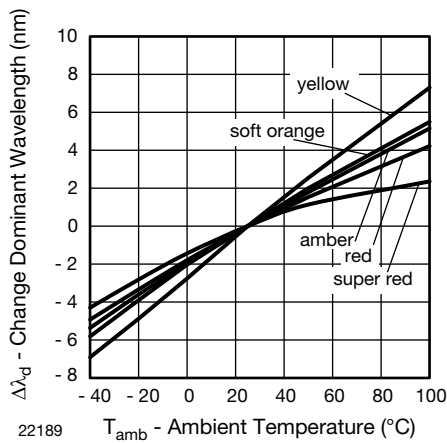
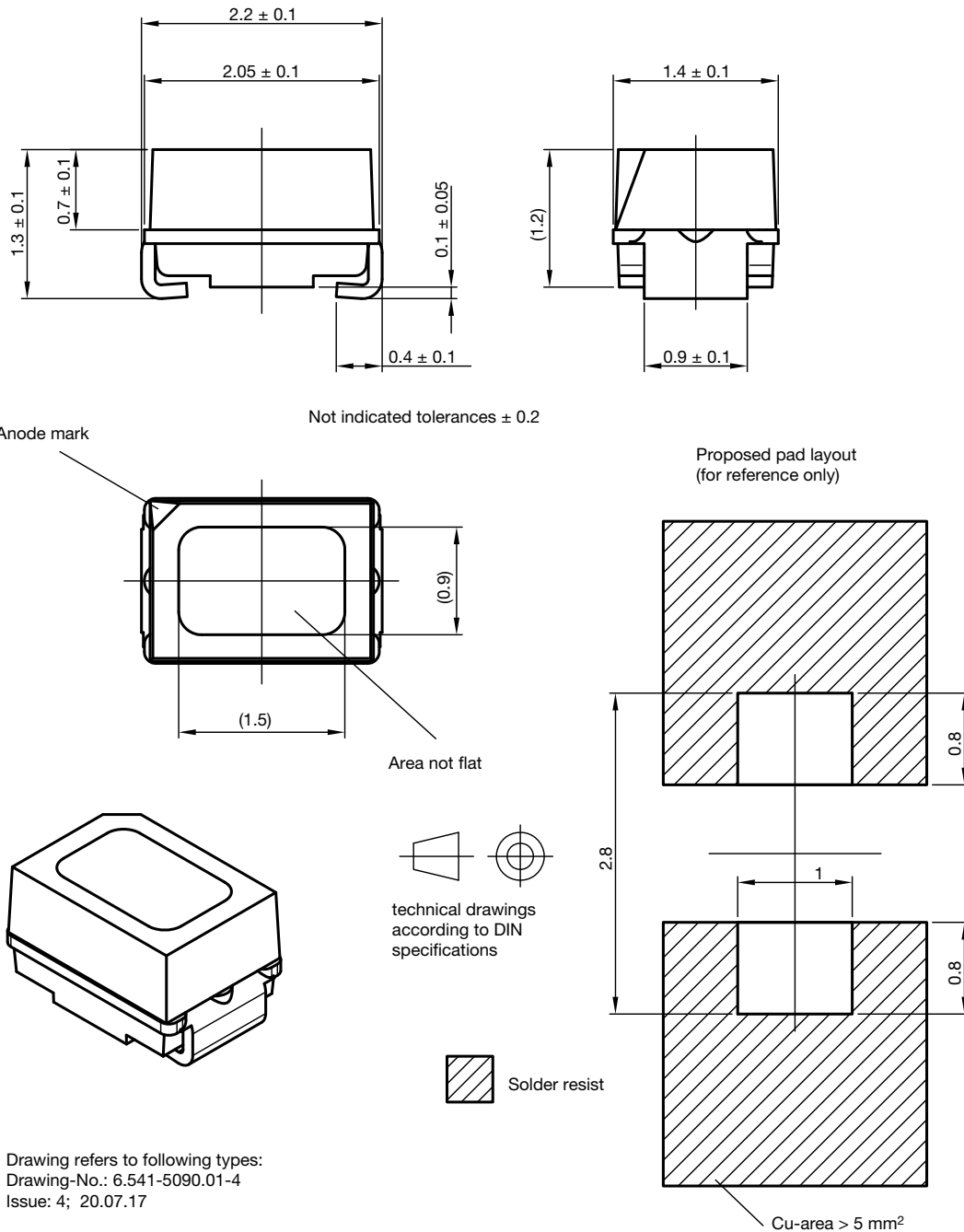

Fig. 9 - Change of Dominant Wavelength vs. Ambient Temperature



PACKAGE DIMENSIONS in millimeters





TAPE DIMENSIONS in millimeters

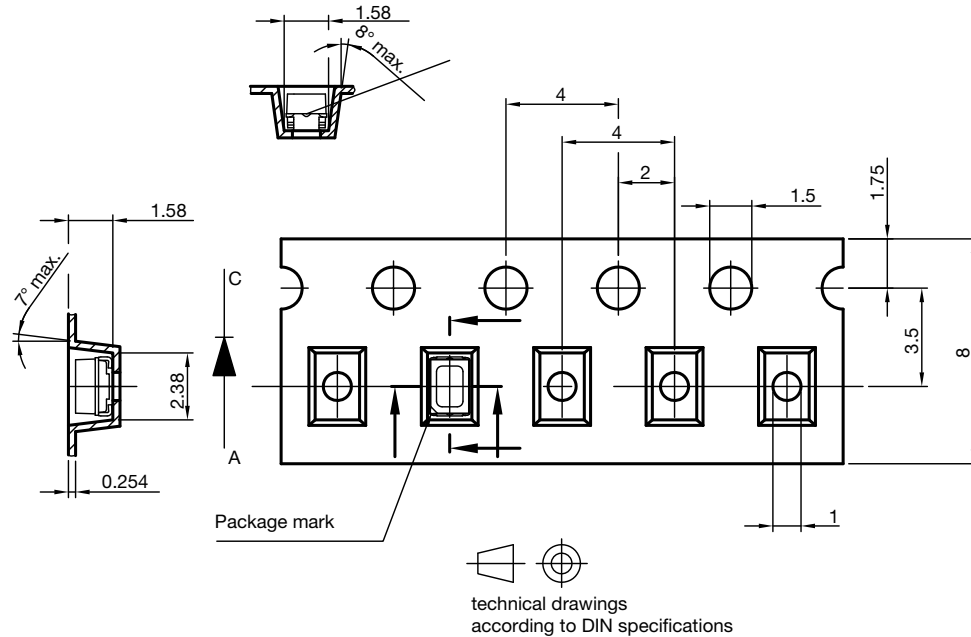

Drawing refers to following types: Mini - SMD - LED with reverse polarity: VLM. 233..., VLM. 235...
 Drawing-No.: 9.700-5381.01-4
 Issue: 2; 20.07.17

LEADER AND TRAILER DIMENSIONS in millimeters

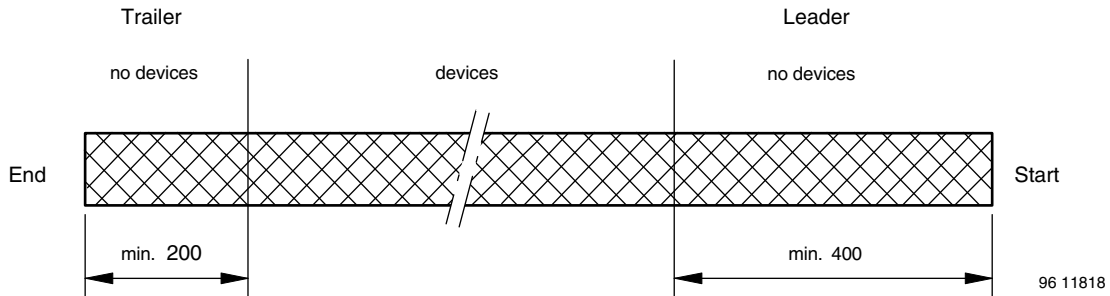

GS08 = 3000 pcs

COVER TAPE PEEL STRENGTH

According to DIN EN 60286-3
 0.1 N to 1.3 N
 300 mm/min ± 10 mm/min
 165° to 180° peel angle

LABEL

Standard bar code labels for finished goods

The standard bar code labels are product labels and used for identification of goods. The finished goods are packed in final packing area. The standard packing units are labeled with standard bar code labels before transported as finished goods to warehouses. The labels are on each packing unit and contain Vishay Semiconductor GmbH specific data.



SOLDERING PROFILE

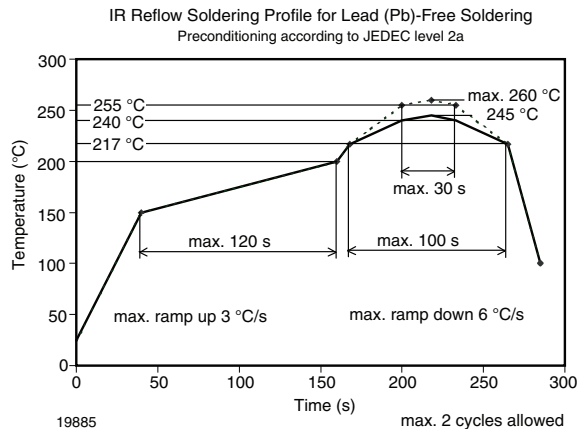

Fig. 10 - Vishay Lead (Pb)-free Reflow Soldering Profile (acc. to J-STD-020)

BAR CODE PRODUCT LABEL (example)



- A. 2D bar code
B. Part number = Vishay part number
C. QTY = Quantity
D. Sel. code = selection code (binning)
E. PTC = Code of manufacturing plant
F. Batch = date code: year / week / plant code
G. Region code
H. SL = sales location
I. Terminations finishing
J. Lead (Pb)-free symbol
K. Halogen-free symbol
L. RoHS symbol

DRY PACKING

The reel is packed in an anti-humidity bag to protect the devices from absorbing moisture during transportation and storage.

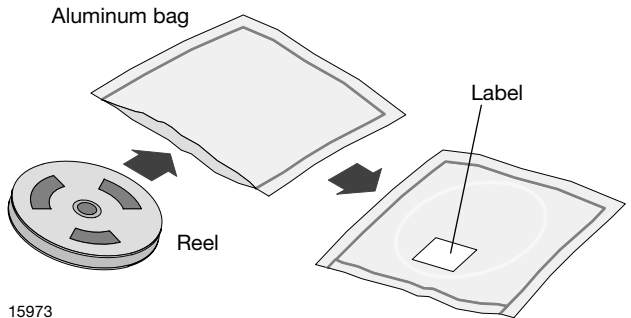

15973

FINAL PACKING

The sealed reel is packed into a cardboard box. A secondary cardboard box is used for shipping purposes.

RECOMMENDED METHOD OF STORAGE

Dry box storage is recommended as soon as the aluminum bag has been opened to prevent moisture absorption. The following conditions should be observed, if dry boxes are not available:

- Storage temperature 10 °C to 30 °C
Storage humidity ≤ 60 % RH max.

After more than 672 h under these conditions moisture content will be too high for reflow soldering.

In case of moisture absorption, the devices will recover to the former condition by drying under the following condition:

- 192 h at 40 °C + 5 °C / - 0 °C and < 5 % RH (dry air/nitrogen) or
96 h at 60 °C + 5 °C and < 5 % RH for all device containers or
24 h at 100 °C + 5 °C not suitable for reel or tubes.

An EIA JEDEC standard JESD22-A112 level 2a label is included on all dry bags.

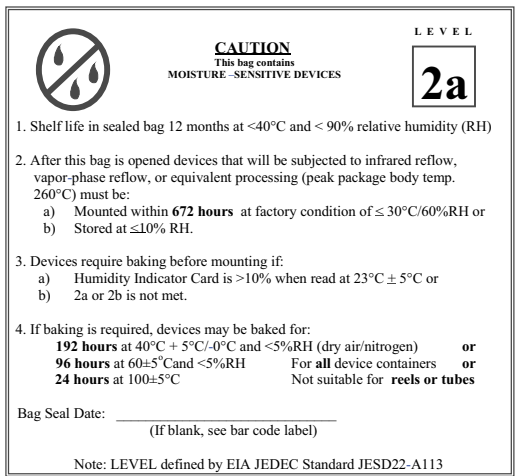

Example of JESD22-A112 level 2a label

ESD PRECAUTION

Proper storage and handling procedures should be followed to prevent ESD damage to the devices especially when they are removed from the antistatic shielding bag. Electrostatic sensitive devices warning labels are on the packaging.

VISHAY SEMICONDUCTORS STANDARD BAR CODE LABEL

The Vishay Semiconductors standard bar code labels are printed at final packing areas. The labels are on each packing unit and contain Vishay Semiconductors specific data.



Disclaimer

ALL PRODUCT, PRODUCT SPECIFICATIONS AND DATA ARE SUBJECT TO CHANGE WITHOUT NOTICE TO IMPROVE RELIABILITY, FUNCTION OR DESIGN OR OTHERWISE.

Vishay Intertechnology, Inc., its affiliates, agents, and employees, and all persons acting on its or their behalf (collectively, "Vishay"), disclaim any and all liability for any errors, inaccuracies or incompleteness contained in any datasheet or in any other disclosure relating to any product.

Vishay makes no warranty, representation or guarantee regarding the suitability of the products for any particular purpose or the continuing production of any product. To the maximum extent permitted by applicable law, Vishay disclaims (i) any and all liability arising out of the application or use of any product, (ii) any and all liability, including without limitation special, consequential or incidental damages, and (iii) any and all implied warranties, including warranties of fitness for particular purpose, non-infringement and merchantability.

Statements regarding the suitability of products for certain types of applications are based on Vishay's knowledge of typical requirements that are often placed on Vishay products in generic applications. Such statements are not binding statements about the suitability of products for a particular application. It is the customer's responsibility to validate that a particular product with the properties described in the product specification is suitable for use in a particular application. Parameters provided in datasheets and / or specifications may vary in different applications and performance may vary over time. All operating parameters, including typical parameters, must be validated for each customer application by the customer's technical experts. Product specifications do not expand or otherwise modify Vishay's terms and conditions of purchase, including but not limited to the warranty expressed therein.

Except as expressly indicated in writing, Vishay products are not designed for use in medical, life-saving, or life-sustaining applications or for any other application in which the failure of the Vishay product could result in personal injury or death. Customers using or selling Vishay products not expressly indicated for use in such applications do so at their own risk. Please contact authorized Vishay personnel to obtain written terms and conditions regarding products designed for such applications.

No license, express or implied, by estoppel or otherwise, to any intellectual property rights is granted by this document or by any conduct of Vishay. Product names and markings noted herein may be trademarks of their respective owners.