

GENERAL DESCRIPTION

OB3636A is a flyback controller with high power factor, low THD and high constant voltage (CV) precision. It can achieve low system cost for an isolated application by primary side control in a single stage converter. It significantly simplifies the CV system design by eliminating the secondary side feedback components and the opto-coupler.

The proprietary CV control scheme is used and the system can achieve high power factor with constant on-time control scheme. Quasi-resonant (QR) operation and clamping frequency greatly improves the system efficiency. The advanced start-up technology is used to meet the fast start-up time requirement.

OB3636A offers comprehensive protection including open circuit protection, short circuit protection, over load protection, cycle-by-cycle current limiting, built-in leading edge blanking (LEB), VDD under voltage lockout (UVLO), etc.

OB3636A is offered in SOT23-6 package.

FEATURES

- High precision constant voltage regulation
- Primary-side sensing and regulation without TL431 and opto-coupler
- High PF (>0.9)
- Low THD (<10%)
- Fast start-up
- Low system cost and high efficiency
- Quasi-resonant operation
- Short circuit protection
- Open circuit protection
- Cycle-by-cycle current limiting
- Built-in leading edge blanking (LEB)
- VDD under voltage lockout with hysteresis (UVLO)
- VDD over voltage protection
- Over temperature protection (OTP)
- Over load protection (OLP)
- Audio Noise Free

APPLICATIONS

- LED lighting

TYPICAL APPLICATION

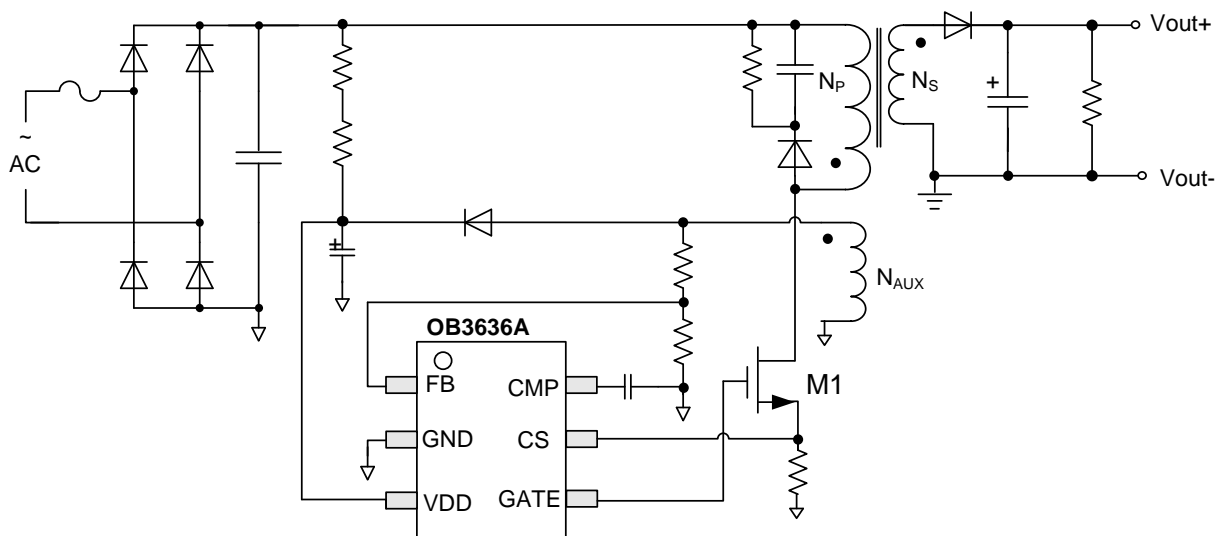

GENERAL INFORMATION

Pin Configuration

The pin map is shown as below for SOT23-6.

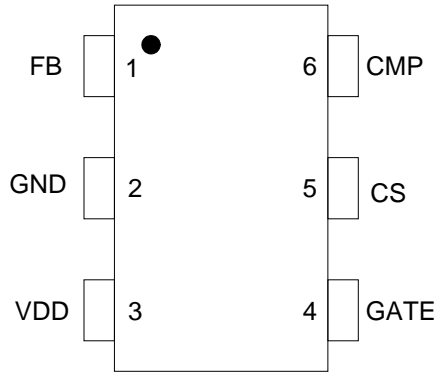

Ordering Information

Part Number	Description
OB3636AMP	SOT23-6, Halogen-free in T&R

Note: All Devices are offered in Halogen-free Package if not otherwise noted.

Package Dissipation Rating

Package	R θ JA (°C/W)
SOT23-6	200

Absolute Maximum Ratings

Parameter	Value
VDD Voltage	-0.3 to 40V
GATE Voltage	-0.3 to 40V
CS Input Voltage	-0.3 to 7V
FB Input Voltage	-0.3 to 7V
CMP Voltage	-0.3 to 7V
Min/Max Operating Junction Temperature T _J	-40 to 150 °C
Operating Ambient Temperature T _A	-20 to 85 °C
Min/Max Storage Temperature T _{stg}	-55 to 150 °C
Lead Temperature (Soldering, 10secs)	260 °C

Note: Stresses beyond those listed under "absolute maximum ratings" may cause permanent damage to the device. These are stress ratings only, functional operation of the device at these or any other conditions beyond those indicated under "recommended operating conditions" is not implied. Exposure to absolute maximum-rated conditions for extended periods may affect device reliability.

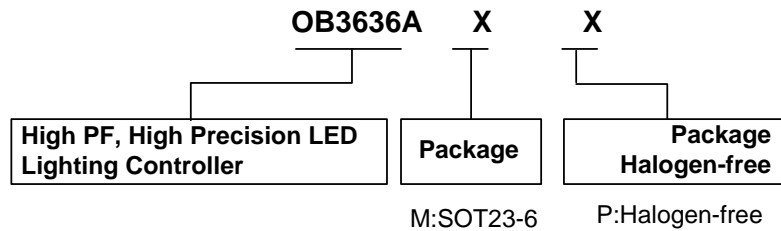

Marking Information

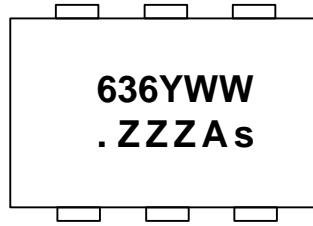

Y:Year Code
 WW:Week Code(01-52)
 ZZZ: Lot code
 A:Character Code
 s: Internal code

TERMINAL ASSIGNMENTS

Pin Num	Pin Name	I/O	Description
1	FB	I	Voltage feedback from auxiliary winding. Connected to resistor divider from auxiliary winding reflecting output voltage.
2	GND	P	Power ground.
3	VDD	P	Power supply.
4	GATE	O	Gate driver output for power MOSFET.
5	CS	I	Current sense input pin.
6	CMP	O	Loop compensation pin. A capacitor is connected between CMP and GND.

BLOCK DIAGRAM

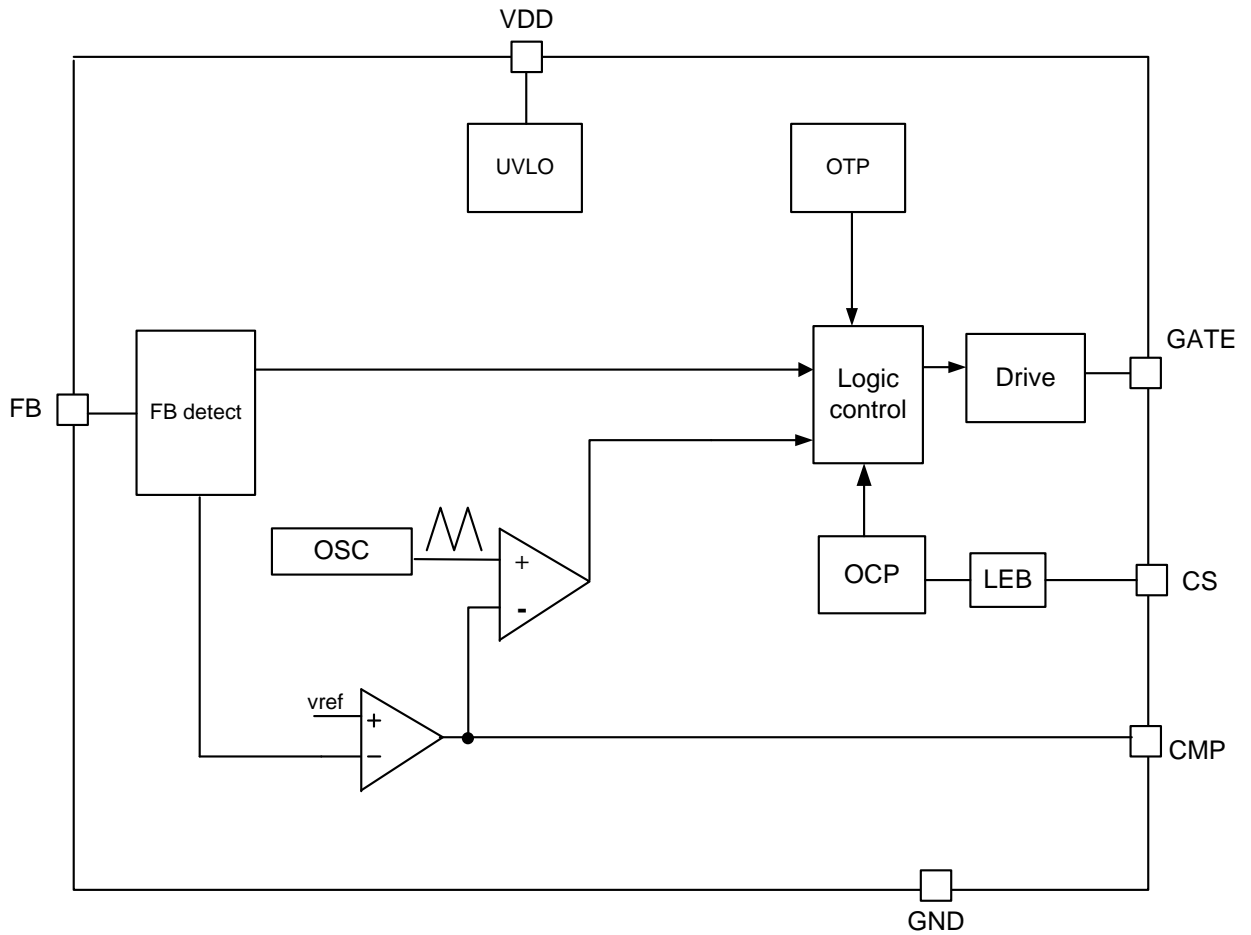

ELECTRICAL CHARACTERISTICS

(TA = 25°C, VDD=20V, if not otherwise noted)

Symbol	Parameter	Test Conditions	Min	Typ.	Max	Unit
Supply Voltage (VDD) Section						
I_start-up	Start up Current	VDD=UVLO(OFF)-1V		3	7	uA
I_OP	Static Current	VDD=20V		850	1100	uA
UVLO(ON)	VDD Under Voltage Lockout Enter	VDD falling	7	8.1	9.2	V
UVLO(OFF)	VDD Under Voltage Lockout Exit	VDD rising	20	22.5	25	V
VDD_OVP	VDD Over Voltage Protection		29	32	35	V
FB Section						
Vovp	Output over voltage protection		3	3.2	3.4	V
Vth_fb_scp	FB short protection			0.4		V
Gm amplifier section						
Vref	Error Amplifier Reference Voltage		2.425	2.5	2.575	V
Gm	Error Amplifier Transconductance Gain			40		uS
CS Section						
TLEB	Leading Edge Blanking time			300		ns
Vth_oc	Over Current Threshold Voltage	Ton=0us		0.7		V
QR Section						
Fmax	Maximum Clamping Frequency			100		KHz
Toff_max	Maximum Off Time			70		us
Ton_max	Maximum On Time			20		us
Fmin	Minimum frequency			500		Hz
OTP section						
OTP	Over Temperature Protection trigger threshold			150		°C
Gate Drive Output Section						
Vclamp	Output Clamping Voltage			12		V
Tr	Rising Edge Time	CL=1nF		80		ns
Tf	Falling Edge Time	CL=1nF		30		ns

CHARACTERIZATION PLOTS

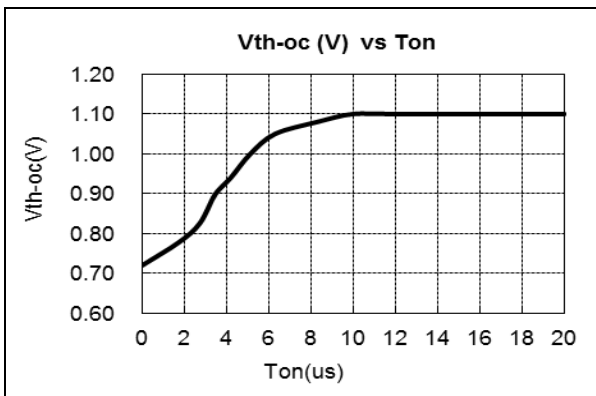
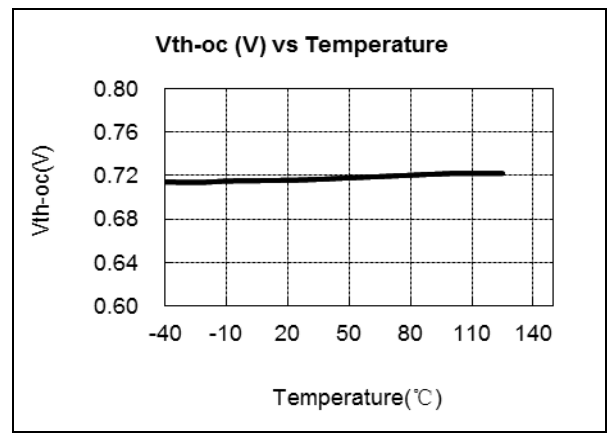
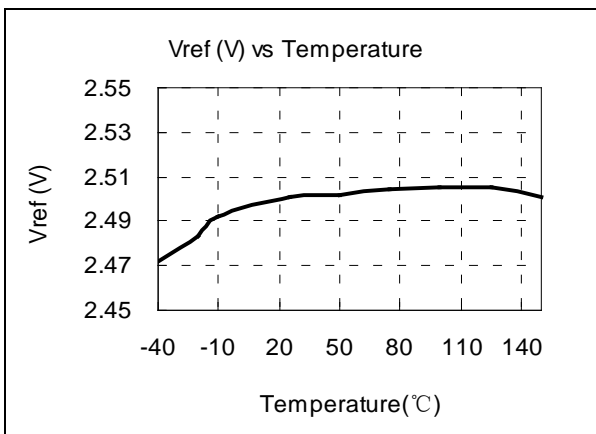
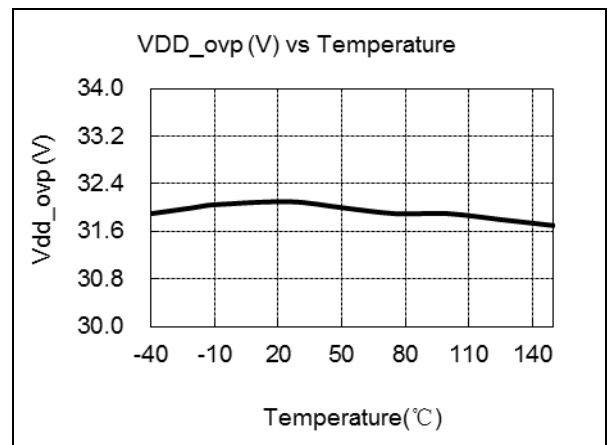
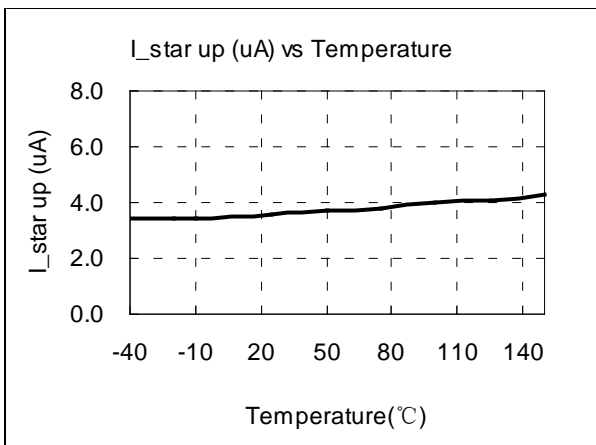
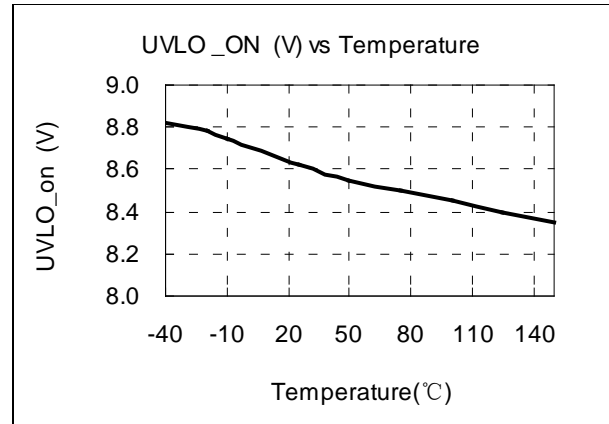
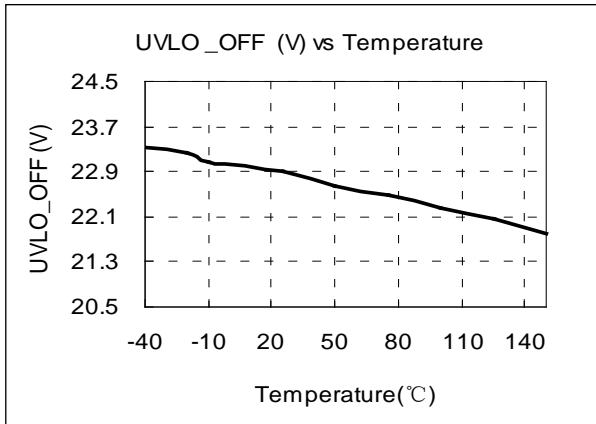

OPERATION DESCRIPTION

OB3636A is a cost effective PSR power switch optimized for high PF and low THD constant voltage applications. It operates in primary side sensing and regulation, thus opto-coupler and TL431 are not required. Proprietary built-in constant on time control can achieve high power factor control meeting most application requirements.

Startup

The advanced start-up technology is used in OB3636A to meet the start-up time requirement. Low start-up current is designed in OB3636A so that VDD could be charged up above UVLO threshold with small charging current.

During the startup, the capacitor at CMP pin is pulled up quickly. OB3636A operates at open circuit and over-current protection is set cycle-by-cycle until it senses the output voltage by FB pin up to about 1.3V. After that OB3636A operates in close loop, the transconductance of error amplifier is set to 40uS (typical).

Error Amplifier

Connected to a resistor divider from output line, the inverting input of the Error Amplifier (EA) is compared to an internal reference voltage (2.5V) to regulate the output voltage.

The EA output is internally connected to the CMP pin and externally connected for loop compensation. It is usually realized with a capacitor which connected between GND and EA output. The system loop bandwidth is set below 20 Hz to suppress the AC ripple of the line voltage.

Output voltage regulation

In order to achieve primary side constant voltage control, the output voltage is detected by the auxiliary winding voltage. During OFF time, the voltage across the auxiliary winding is:

$$V_A = (V_{OUT} + V_{DF}) \frac{N_A}{N_S}$$

N_A is the turns of auxiliary winding
 N_S is the turns of secondary winding
 V_{DF} is the forward voltage of the power diode

At the current zero-crossing point, V_{DF} is nearly zero, so V_{OUT} is proportional with V_A exactly. The voltage of this point is sampled by the IC as the feedback of output voltage. The resistor divider is designed by:

$$V_{OUT} = \frac{V_{ref}}{\frac{N_A}{N_S} \frac{R_2}{R_1 + R_2}}$$

V_{ref} is the internal voltage reference
 R_1 is resistance of the high side divider
 R_2 is resistance of the low side divider

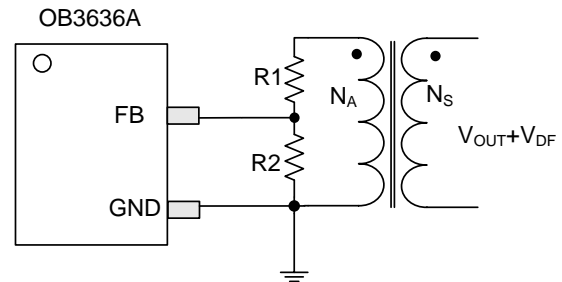

Figure.1 FB Section Circuit

PF and THD

The duration of the turn on period t_{on} is generated by comparing an internal fixed saw-tooth wave with the voltage on the CMP pin. During steady state operation, the voltage on the CMP pin V_{cmp} is slowly varying due to a large external capacitor connected at the CMP pin, therefore the turn on time t_{on} is constant. In a fly-back topology, constant turn on time and quasi-resonant operation provide high power factor (PF) and low total harmonic distortion (THD).

Current Sensing and Leading Edge Blanking

Cycle-by-Cycle current limiting (OCP) is offered in OB3636A. The switching current is detected by a sense resistor connected between the CS pin and GND. An internal leading edge blanking circuit chops off the sense voltage spike at initial MOSFET on state due to snubber diode reverse recovery so that the external RC filter is no longer required. The current limit comparator is disabled at this blanking time and thus the external MOSFET cannot be turned off during this blanking time.

Quasi-Resonant Operation

OB3636A performs quasi-resonant detection through FB pin by monitoring the voltage activity on the primary windings in series with external resistors. When the stored energy of fly-back transformer is fully released to the output, the voltage at FB pin decreases. When FB pin voltage falls below 0V (typical), an internal FB comparator is triggered and a new PWM switching cycle is initiated following the FB triggering.

Short Circuit Protection

When output is short, the FB voltage is low. If the voltage at FB pin is lower than a threshold of approximately 0.4 V (typical), the threshold voltage of OCP is reduced to 0.4 V (typical). The power dissipation is greatly reduced in this way.

Open Circuit Protection

When the open circuit happens, the FB pin voltage is high. If the voltage at FB pin is higher than a threshold of approximately 3.2V (typical), the IC will shut down and enter power on startup sequence thereafter.

Over Load Protection

OB3636A detects output power and offers over load protection (OLP). If output power exceeds power limit threshold value (about 1.3 times of full load), control circuit reacts to turn off the power MOSFET. After 150ms (typical) the OLP state will be reset.

Gate Drive Output

The output stage is designed to ensure zero

cross-conduction current. This minimizes heat dissipation, increase efficiency, and enhance reliability. The built-in 12V clamp at the gate output protects the MOSFET gate from high voltage stress.

Over Temperature Protection

Over temperature protection is offered in OB3636A. When temperature of the device rises over 150°C (typical), the IC will shut down. And the state will be kept until the device restarts.

Protection Controls

OB3636A ensures good reliability design through its good protection coverage. Output dynamic and static over-voltage protection (OVP), Over Load Protection (OLP), VDD under voltage lockout (UVLO), VDD over-voltage protection (VDD OVP), cycle-by-cycle current limiting, Diode short protection and output gate clamp are standard features provided by OB3636A.

PACKAGE MECHANICAL DATA

PACKAGE OUTLINE DIMENSIONS

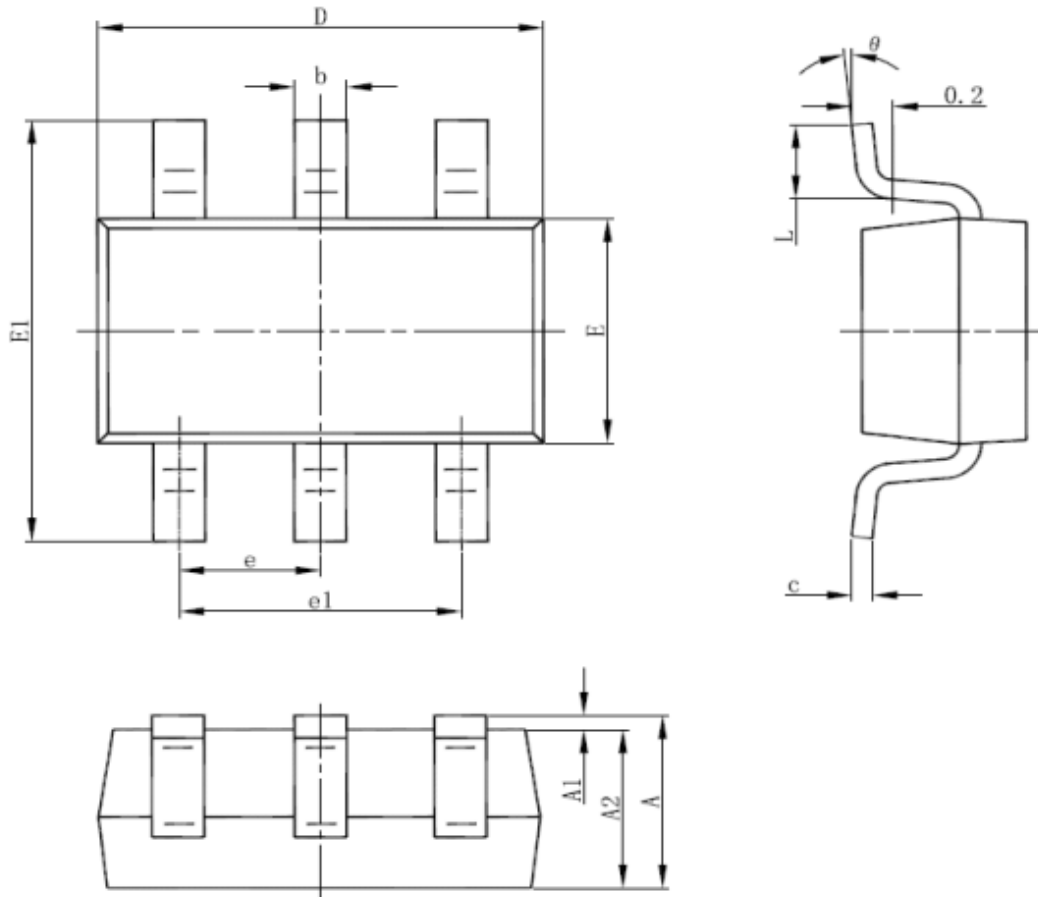

Symbol	Dimensions In Millimeters		Dimensions In Inches	
	Min	Max	Min	Max
A	1.000	1.450	0.039	0.057
A1	0.000	0.150	0.000	0.006
A2	0.900	1.300	0.035	0.051
b	0.300	0.500	0.012	0.020
c	0.080	0.220	0.003	0.009
D	2.800	3.020	0.110	0.119
E	1.500	1.726	0.059	0.068
E1	2.600	3.000	0.102	0.118
e	0.950 (BSC)		0.037 (BSC)	
e1	1.800	2.000	0.071	0.079
L	0.300	0.600	0.012	0.024
θ	0°	8°	0°	8°

IMPORTANT NOTICE

RIGHT TO MAKE CHANGES

On-Bright Electronics Corp. reserves the right to make corrections, modifications, enhancements, improvements and other changes to its products and services at any time and to discontinue any product or service without notice. Customers should obtain the latest relevant information before placing orders and should verify that such information is current and complete.

WARRANTY INFORMATION

On-Bright Electronics Corp. warrants performance of its hardware products to the specifications applicable at the time of sale in accordance with its standard warranty. Testing and other quality control techniques are used to the extent it deems necessary to support this warranty. Except where mandated by government requirements, testing of all parameters of each product is not necessarily performed.

On-Bright Electronics Corp. assumes no liability for application assistance or customer product design. Customers are responsible for their products and applications using On-Bright's components, data sheet and application notes. To minimize the risks associated with customer products and applications, customers should provide adequate design and operating safeguards.

LIFE SUPPORT

On-Bright Electronics Corp.'s products are not designed to be used as components in devices intended to support or sustain human life. On-bright Electronics Corp. will not be held liable for any damages or claims resulting from the use of its products in medical applications.

MILITARY

On-Bright Electronics Corp.'s products are not designed for use in military applications. On-Bright Electronics Corp. will not be held liable for any damages or claims resulting from the use of its products in military applications.