

WL2852K

High Input Voltage, Low Quiescent Current LDO

[Http://www.sh-willsemi.com](http://www.sh-willsemi.com)

Descriptions

The WL2852K series is a high accuracy, high input voltage low quiescent current, high speed, and low dropout Linear regulator with high ripple rejection. The device is manufactured with Bi-CMOS process.

The WL2852K offers over-current limit and over temperature protection to ensure the device working in well conditions.

The WL2852K regulators are available in standard SOT-89-3L packages. Standard products are Pb-free and Halogen-free.

Features

- Supply Voltage : 4.75V~40V
- Output Range : 1.8V~5.7V
- Output Accuracy : <+/-2%
- Output Current : 100mA (Up to 150mA Typ.)
- PSRR : 60dB @ 100Hz
- Dropout Voltage : 800mV @ I_{OUT}=100mA
- Quiescent Current : 10μA@V_{IN}=7V(Typ.)
- Recommend Capacitor : 10uF
(Locate Cin as close to the Vin pin as possible.)

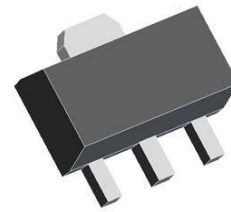

SOT-89

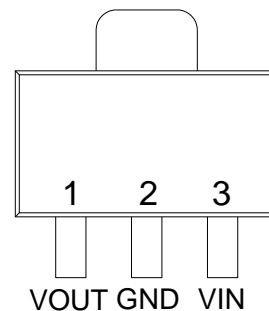

Pin Configuration (Top View)

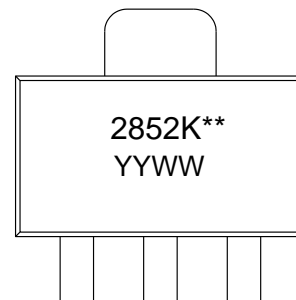

For detail marking information, please see page 10.

Marking

Order Information

For detail order information, please see page 10.

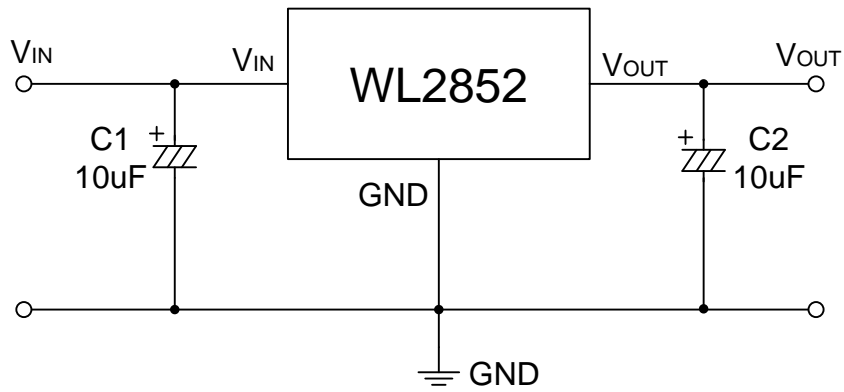
Typical Application

Pin Description

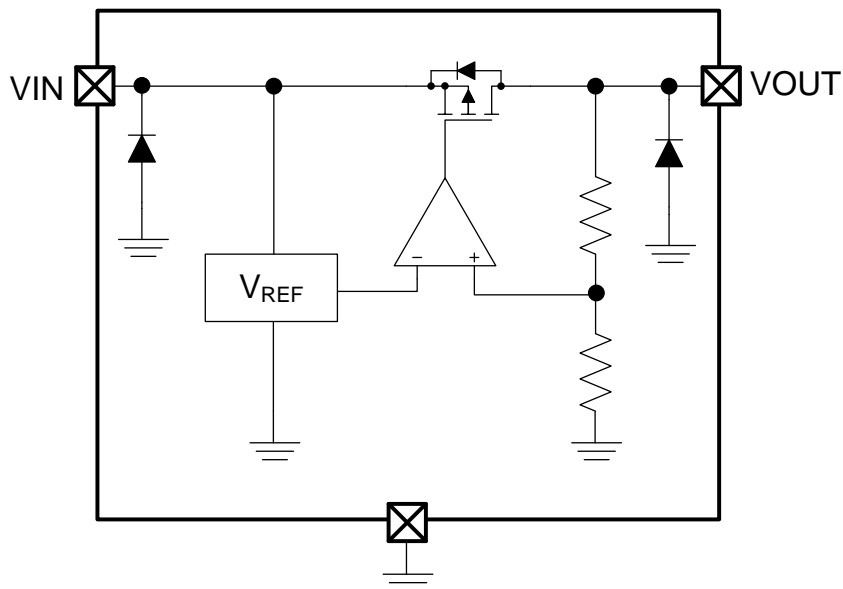
PIN	Symbol	Description
1	VOUT	Voltage Output
2	GND	Ground
3	VIN	Voltage Input

Block Diagram

Absolute Maximum Ratings

Parameter	Value	Unit
Power Dissipation	Internal limited	mW
V _{IN} Range	-0.3~45	V
V _{OUT} Range	-0.3~6.5	V
Lead Temperature Range	260	°C
Storage Temperature Range	-55 ~ 150	°C
Operating Junction Temperature Range	150	°C
ESD MM	400	V
ESD HBM	4K	V

Recommend Operating Ratings

Parameter	Value	Unit
Operating Supply voltage	4.75~40	V
Operating Temperature Range	-40~85	°C
Thermal Resistance (On PCB) , R _{θJA}	43.5	°C/W
Power Dissipation	1000	mW

Electronics Characteristics (Ta=25°C, V_{IN}=12V, C_{IN}=C_{OUT}=10uF, unless otherwise noted)

Symbol	Parameter	Test Condition	WL2852K SPEC			Unit
			Min.	Typ.	Max.	
V _{IN}	Input Range	I _{OUT} =10mA	4.75		40	V
V _{OUT}	Output Range	I _{OUT} =10mA	V _{OUT} *0.98	V _{OUT}	V _{OUT} *1.02	V
ΔV _{OUT}	Output Voltage	V _{IN} =12V, I _{OUT} =10mA	5.586	5.7	5.814	V
			5.194	5.3	5.406	V
			4.9	5.0	5.1	V
			4.312	4.4	4.488	V
			3.920	4.0	4.080	V
			3.528	3.6	3.672	V
			3.234	3.3	3.366	V
I _{OUT_PK}	Maximum Output Current	V _{IN} =12V, R _L =1Ω	180	280	460	mA
I _Q	Quiescent Current	V _{IN} =7V, No load		10	15	μA
		V _{IN} =24V, No load		11	16	
		V _{IN} =40V, No load		13	20	
V _{DROP}	Dropout Voltage	I _{OUT} =1mA		8	12	mV
		I _{OUT} =100mA		800	1200	
Δ V _{Line}	Line Regulation	V _{IN} =7--24V, V _{OUT} =5V I _{OUT} =1mA		0.02		%V
		V _{IN} =7--45V, V _{OUT} =5V I _{OUT} =1mA		0.1		
Δ V _{Load}	Load Regulation	V _{IN} =12V, I _{OUT} =1--100mA		0.6		%
e _{NO}	Output Noise	I _{OUT} =10mA	-100		+100	μV
PSRR	Ripple Rejection	V _{IN} =10V	f=100Hz	60		dB
		V _{PP} =0.5V	f=1KHz	45		
		I _{OUT} =1mA	f=10KHz	35		
T _{SD}	Thermal Protection	V _{IN} =12V, I _{OUT} =1mA		165		°C
T _{SD_HYS}	Thermal Protection Hys	V _{IN} =12V, I _{OUT} =1mA		30		°C
ΔVo/ΔT	Temperature Coefficient	V _{IN} =12V, I _{OUT} =1mA		±0.5		mv/°C

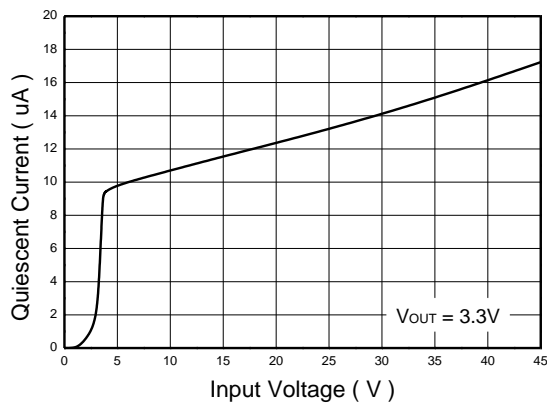
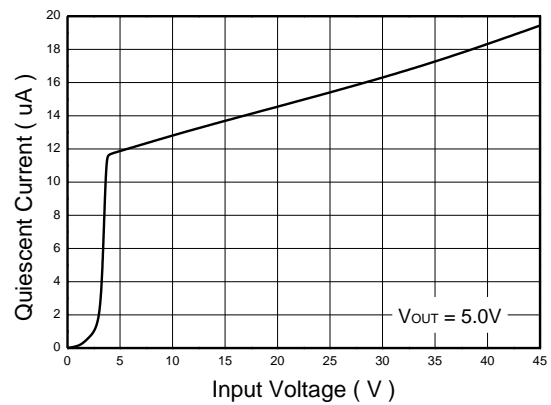
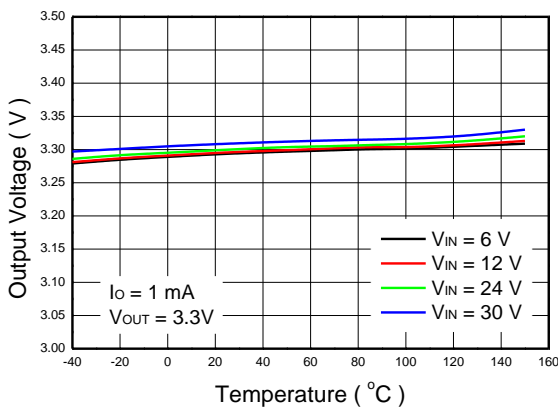
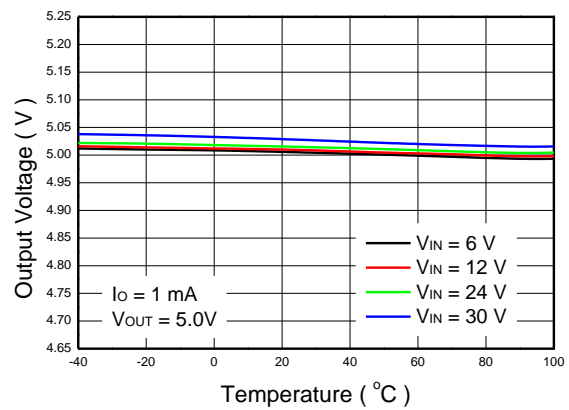
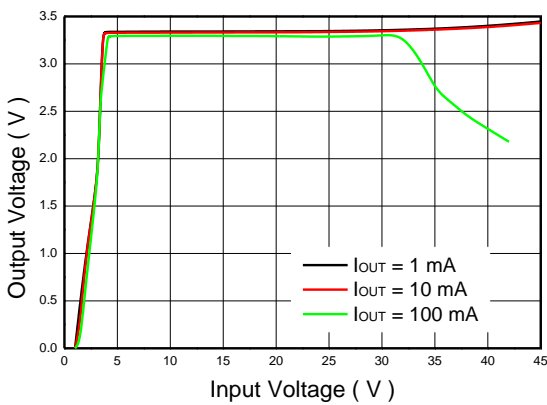
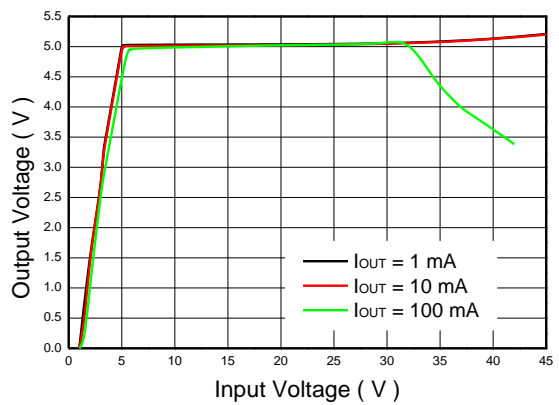
Typical characteristics (Ta=25oC, CIN=COUT=10uF, unless otherwise noted)

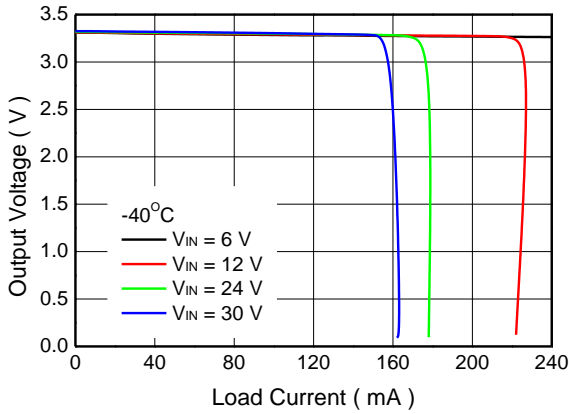
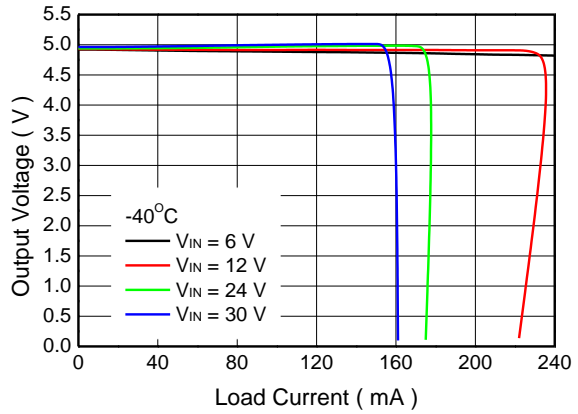
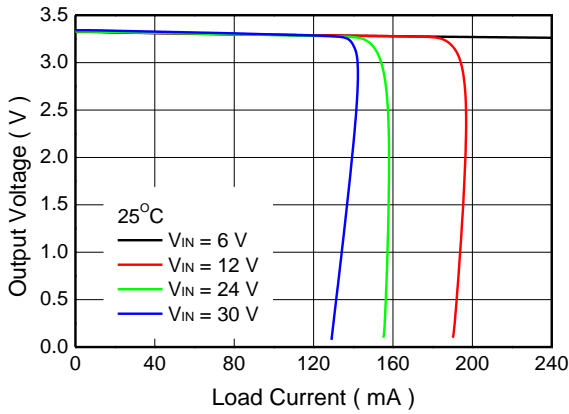
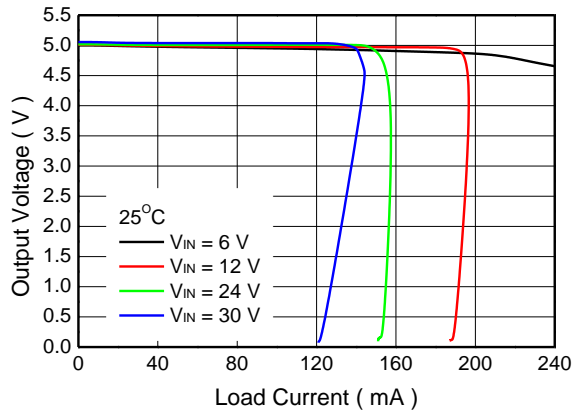
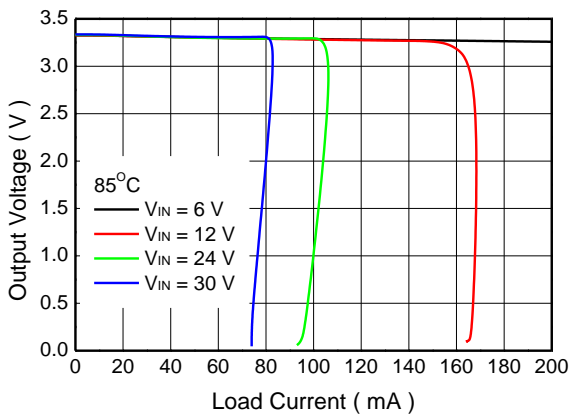
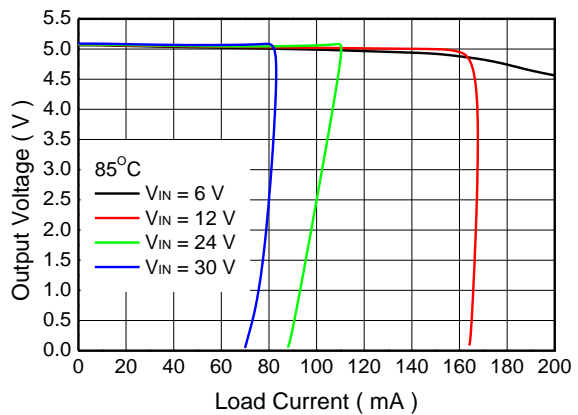
Quiescent Current vs. Input Voltage

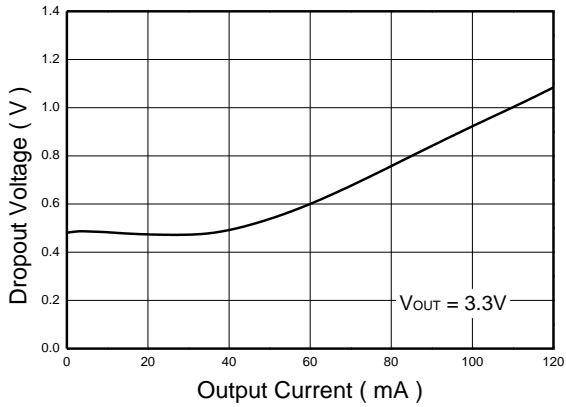
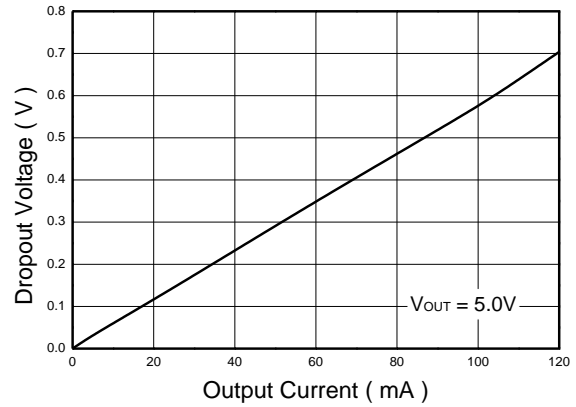
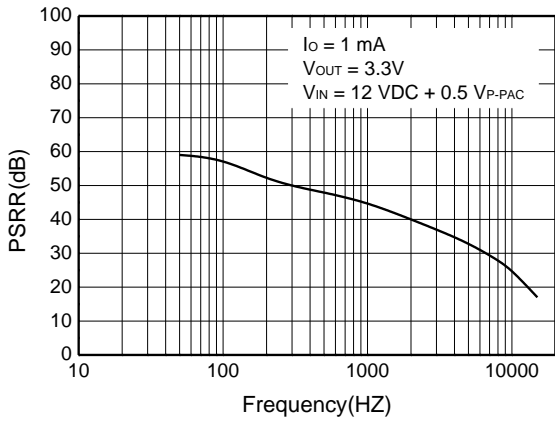
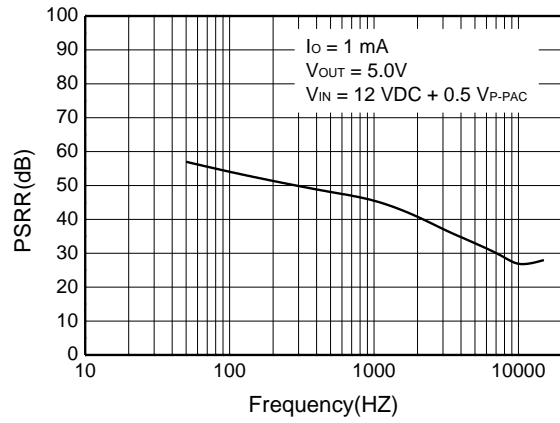
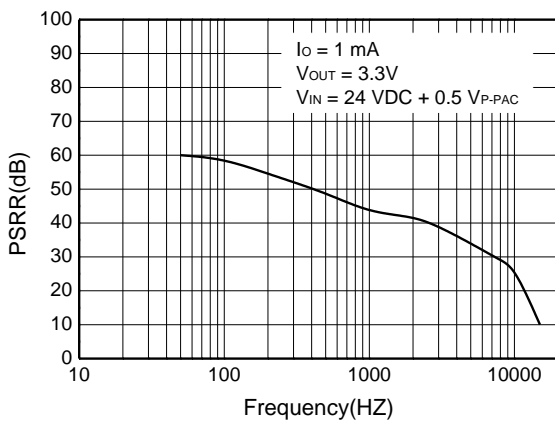
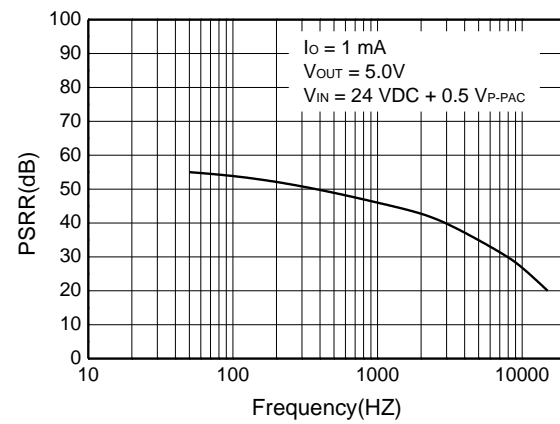
Quiescent Current vs. Input Voltage

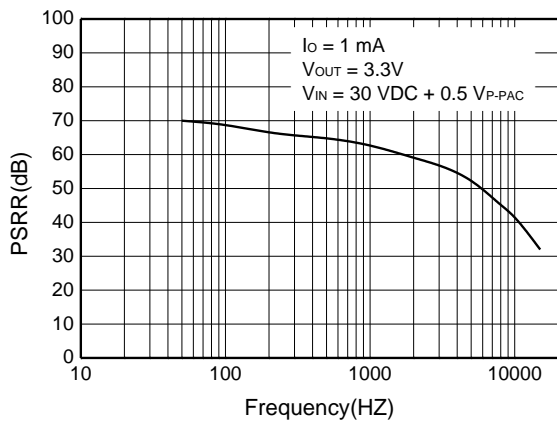
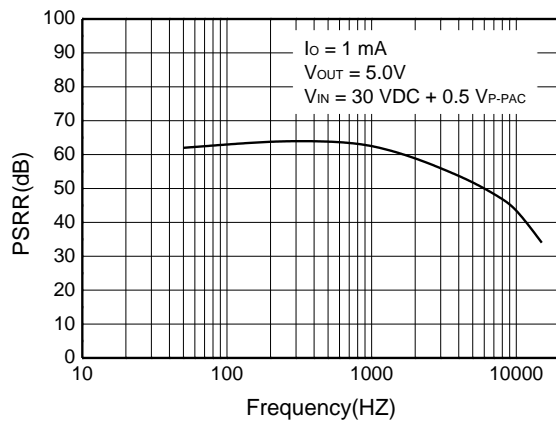
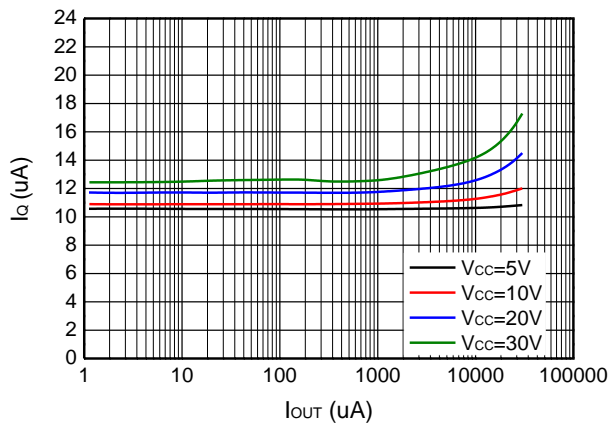
Output Voltage vs. Temperature

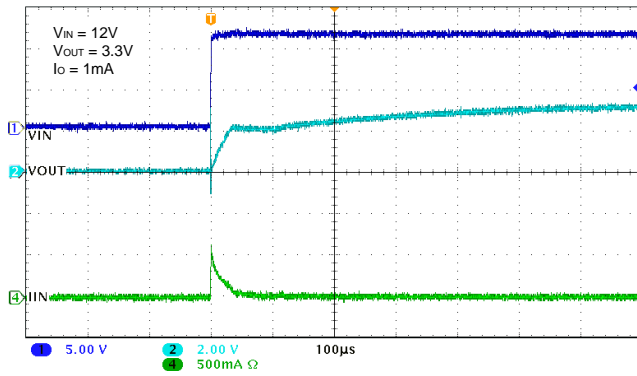
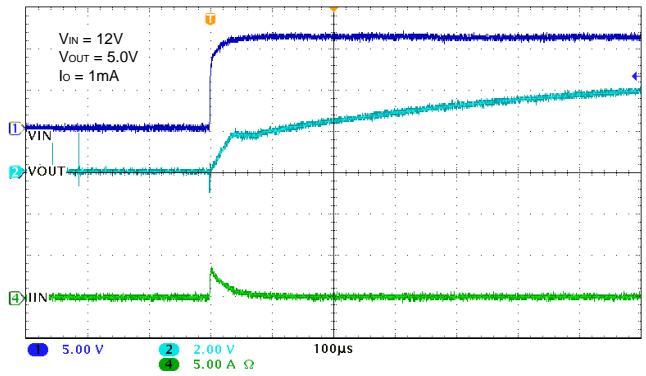
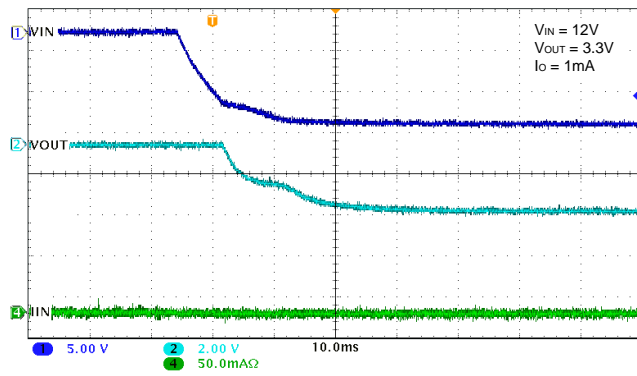
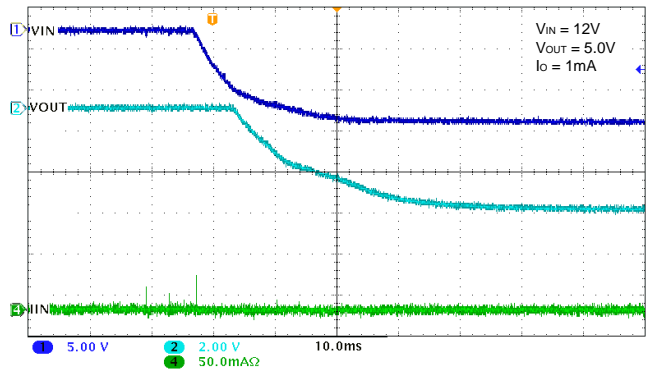
Output Voltage vs. Temperature

Output Voltage vs. Input Voltage

Output Voltage vs. Input Voltage

Output Voltage vs. Load Current

Output Voltage vs. Load Current

Output Voltage vs. Load Current

Output Voltage vs. Load Current

Output Voltage vs. Load Current

Output Voltage vs. Load Current

Dropout Voltage vs. Output Current

Dropout Voltage vs. Output Current

PSRR vs. Frequency

PSRR vs. Frequency

PSRR vs. Frequency

PSRR vs. Frequency

PSRR vs. Frequency

PSRR vs. Frequency

Quiescent Current vs. Output Current

Startup from Power ON

Startup from Power ON

Shutdown from Power OFF

Shutdown from Power OFF

ORDER INFORMATION

Ordering No.	Vout (V)	Package	Operating Temperature	Marking	Shipping
WL2852K33-3/TR	3.3	SOT-89	-40~+85°C	2852KDD YYWW	Tape and Reel, 1000
WL2852K36-3/TR	3.6	SOT-89	-40~+85°C	2852KDG YYWW	Tape and Reel, 1000
WL2852K40-3/TR	4.0	SOT-89	-40~+85°C	2852KEA YYWW	Tape and Reel, 1000
WL2852K44-3/TR	4.4	SOT-89	-40~+85°C	2852KEE YYWW	Tape and Reel, 1000
WL2852K50-3/TR	5.0	SOT-89	-40~+85°C	2852KFA YYWW	Tape and Reel, 1000
WL2852K53-3/TR	5.3	SOT-89	-40~+85°C	2852KFD YYWW	Tape and Reel, 1000
WL2852K57-3/TR	5.7	SOT-89	-40~+85°C	2852KFH YYWW	Tape and Reel, 1000

Marking:

2852K** = Device Code

YY = Year

WW = Week

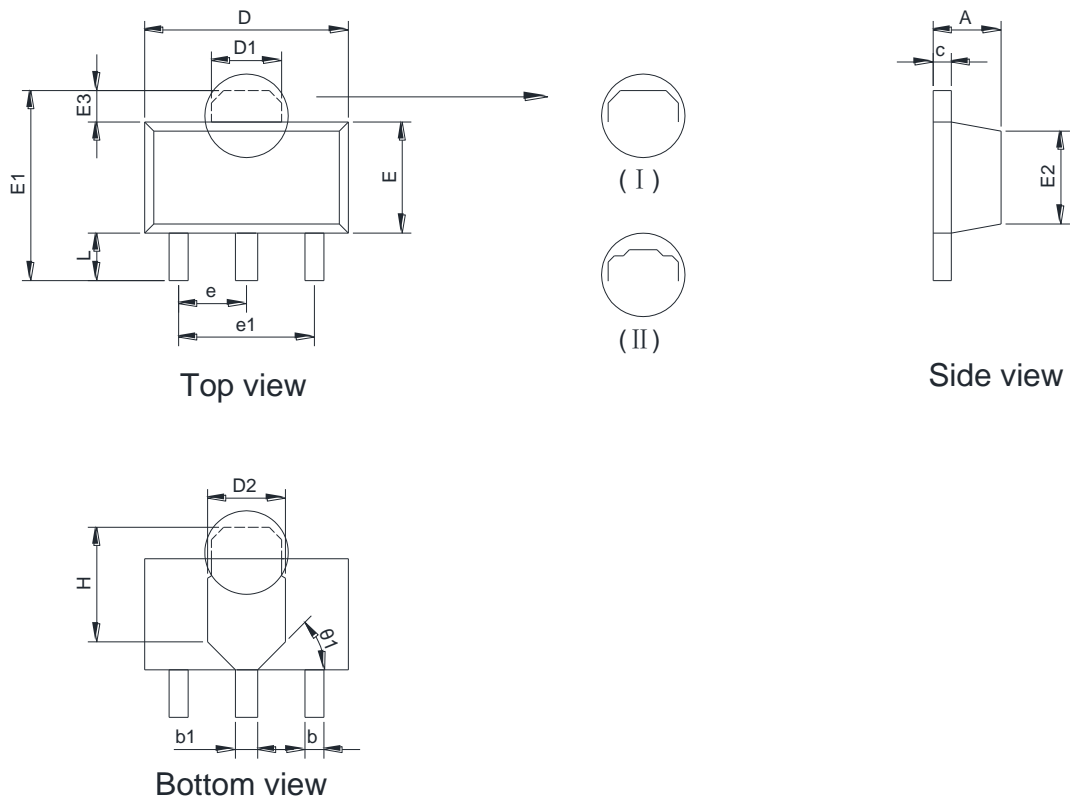
Package outline dimensions
SOT-89-3L

Symbol	Dimensions in millimeters	
	Min.	Max.
A	1.400	1.600
b	0.320	0.520
b 1	0.400	0.580
c	0.350	0.440
D	4.400	4.600
D1	1.550	1.800
D2	1.600	1.900
E	2.300	2.600
E1	3.940	4.250
E2	1.940	2.290
E3	0.600	0.800
H	2.700	3.000
e	1.500TYP	
e 1	3.000TYP	
L	0.890	1.200
θ 1	45°	

TAPE AND REEL INFORMATION

Reel Dimensions

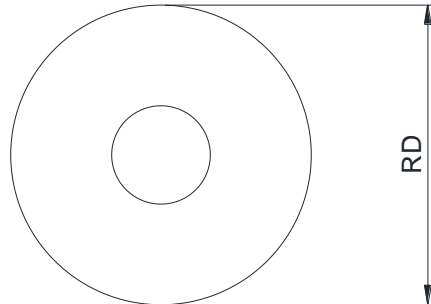

Tape Dimensions

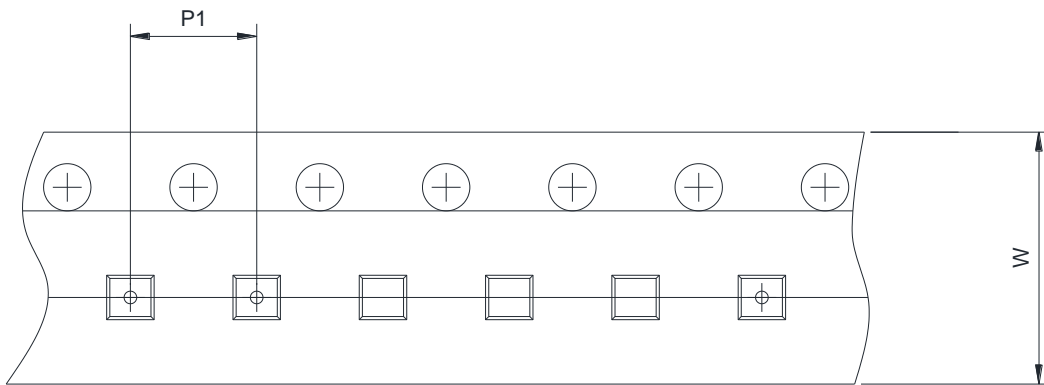

Quadrant Assignments For PIN1 Orientation In Tape

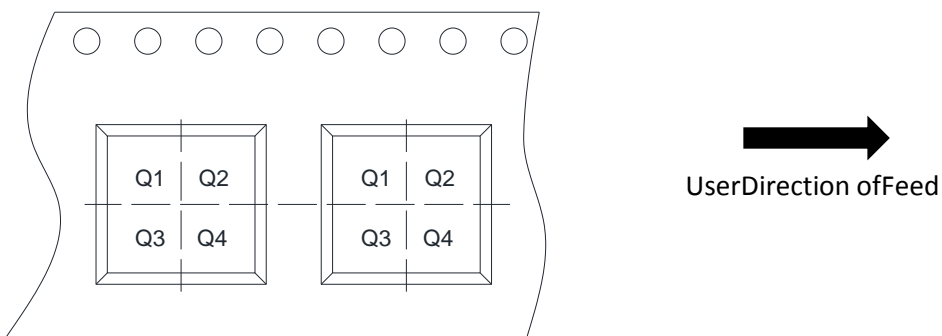

RD	Reel Dimension	■ 7 inch □ 13 inch
P1	Pitch between successive cavity centers	□ 2 mm □ 4 mm ■ 8 mm
W	Overall width of the carrier tape	□ 8 mm ■ 12 mm
Pin1	Pin1 Quadrant	□ Q1 □ Q2 □ Q3 □ Q4