

## WS7918DC

### CMOS High Gain GPS LNA

<http://www.sh-willsemi.com>

#### Descriptions

The WS7918DC is a low noise amplifier (LNA) for GPS receiver applications, available in a small 6-pin DFN package. The WS7918DC requires only one external inductor for input matching.

The WS7918DC is designed to achieve low power dissipation and good performance.

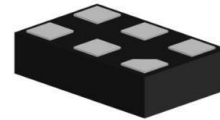

**DFN1109-6L (Bottom view)**

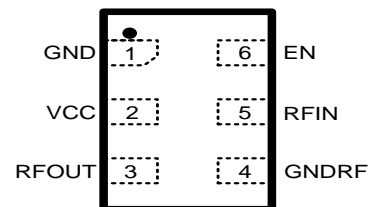

**Pin configuration (Top view)**

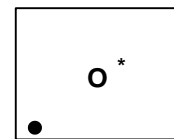

○ = Device code  
\* = Month code (A~Z)

**Marking (Top view)**

#### Features

- Operating frequency: 1550 MHz to 1615 MHz
- Noise figure = 0.65 dB
- Gain = 16.5 dB
- Input 1 dB compression point = -5.0 dBm
- Out-band input IP3 = +5.0 dBm
- Supply voltage: 1.6 V to 3.1 V
- Integrated supply decoupling capacitor
- Supply current: 7.5 mA
- Power-down mode leakage current < 10μA
- One external matching inductor required
- Output decoupled to ground
- ESD protection: HBM > 2.0kV for all pins
- Integrated input/output DC block capacitor
- Integrated output matching
- Package: 6-pin DFN, 1.1 x 0.9 x 0.45 mm<sup>3</sup>
- Process: CMOS

#### Applications

- Cell phones
- Tablets
- Other RF front-end modules

#### Order information

Device	Package	Shipping
WS7918DC-6/TR	DFN1109-6L	3000/Reel&Tape

**Pinning Information**

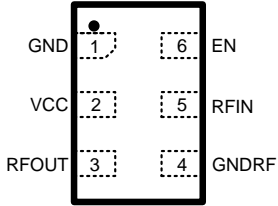
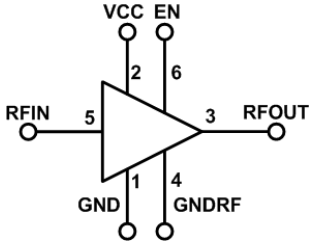
Pin	Description	Transparent top view	Symbol view
1	GND		
2	VCC		
3	RFOUT		
4	GNDRF		
5	RFIN		
6	EN		

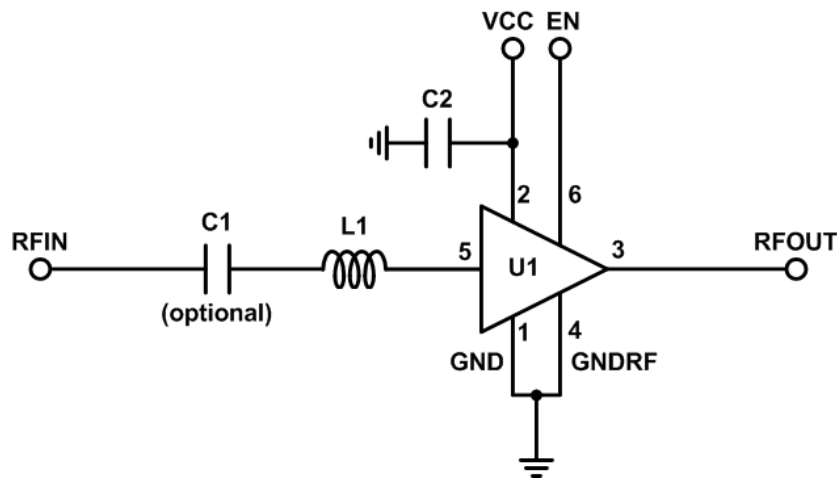
**Application Information**

Symbol	Description	Footprint	Value	Supplier	Comment
U1	WS7918DC	1.1x0.9x0.45 mm <sup>3</sup>	NA	Will-Semi	DUT
C1	Capacitor	0402	1 nF	Various	DC blocking
C2	Capacitor	0402	1 nF	Various	Supply decoupling
L1	Inductor	0402	10 nH	Murata LQW15	Input matching

### Quick Reference Data

freq = 1575.42 MHz;  $V_{CC} = 2.8$  V;  $V_{EN} > 1.2$  V; Temp = 25°C; input matched to 50  $\Omega$  with a 10 nH inductor. The condition is applied unless otherwise specified.

Symbol	Parameter	Condition	Min	Typ	Max	Unit
$V_{CC}$	Supply voltage		1.6	2.8	3.1	V
$I_{CC}$	Supply current			7.5		mA
$G_p$	Power gain			16.5		dB
NF	Noise figure			0.65		dB
$IP_{1dB}$	Input power at 1dB gain compression			-5.0		dBm
$IIP_3$	Input third-order intercept point			+5.0		dBm

### Recommended Operating Conditions

Symbol	Parameter	Condition	Min	Typ	Max	Unit
$V_{CC}$	Supply voltage		1.6	2.8	3.1	V
Temp	Ambient temperature		-40	+25	+85	°C
$V_{EN}$	Input voltage on pin 6 (EN)	OFF state	0		0.3	V
		ON state	1.2		$V_{CC}$	V

### Absolute Maximum Ratings

Maximum ratings are absolute ratings, exceeding only one of these values may cause irreversible damage to the integrated circuit.

Symbol	Parameter	Condition	Min	Max	Unit
$V_{CC}$	Supply voltage		-0.3	3.3	V
$V_{EN}$	Input voltage on pin EN		-0.3	3.3	V
$V_{RFIN}$	Input voltage on pin RFIN		-0.3	3.3	V
$V_{RFOUT}$	Input voltage on pin RFOUT		-0.3	3.3	V
$P_{in}$	RF input power			0	dBm
$T_{STG}$	Storage temperature		-65	+150	°C
$T_J$	Junction temperature			150	°C
$V_{ESD}$	ESD capability all pins	Human Body Model (HBM)		$\pm 2000$	V

**Characteristics**

1550 MHz ≤ f ≤ 1615 MHz; V<sub>CC</sub> = 2.8 V; V<sub>EN</sub> > 1.2 V; Temp = 25°C; input mated to 50 Ω with a 10 nH inductor; The condition is applied unless otherwise specified.

Symbol	Parameter	Conditions	Min	Typ	Max	Unit
I <sub>CC</sub>	Supply current	On state		7.5		mA
		Off state		8.0	10.0	μA
G <sub>p</sub>	Power gain	f = 1575 MHz		16.5		dB
RL <sub>in</sub>	Input return loss	f = 1575 MHz		6.5		dB
RL <sub>out</sub>	Output return loss	f = 1575 MHz		18.0		dB
ISL	Reverse isolation	f = 1575 MHz		27.0		dB
NF	Noise figure	f = 1575 MHz		0.65		dB
IP <sub>1dB</sub>	Input power at 1 dB gain compression	f = 1575 MHz		-5.0		dBm
IIP <sub>3</sub>	Input third-order intercept point <sup>[1]</sup>			+5.0		dBm
K	Rollett stability factor <sup>[2]</sup>		1			
t <sub>on</sub>	Turn-on time				5	μs
t <sub>off</sub>	Turn-off time				5	μs

[1] f<sub>1</sub> = 1713 MHz, f<sub>2</sub> = 1851 MHz, P<sub>in</sub> = -20 dBm

[2] 10M~20GHz

1550 MHz  $\leq$  f  $\leq$  1615 MHz;  $V_{CC} = 1.8$  V;  $V_{EN} > 1.2$  V; Temp = 25°C; input mated to 50  $\Omega$  with a 10 nH inductor; The condition is applied unless otherwise specified.

Symbol	Parameter	Conditions	Min	Typ	Max	Unit
$I_{CC}$	Supply current	On state		8.0		mA
		Off state		4.5	5.5	$\mu$ A
$G_p$	Power gain	f = 1575 MHz		16.0		dB
$RL_{in}$	Input return loss	f = 1575 MHz		6.3		dB
$RL_{out}$	Output return loss	f = 1575 MHz		18.0		dB
ISL	Reverse isolation	f = 1575 MHz		26.0		dB
NF	Noise figure	f = 1575 MHz		0.65		dB
$IP_{1dB}$	Input power at 1 dB gain compression	f = 1575 MHz		-7.0		dBm
$IIP_3$	Input third-order intercept point <sup>[1]</sup>			+3.0		dBm
K	Rollett stability factor <sup>[2]</sup>		1			
$t_{on}$	Turn-on time				5	$\mu$ s
$t_{off}$	Turn-off time				5	$\mu$ s

[1]  $f_1 = 1713$  MHz,  $f_2 = 1851$  MHz,  $P_{in} = -20$  dBm

[2] 10M~20GHz

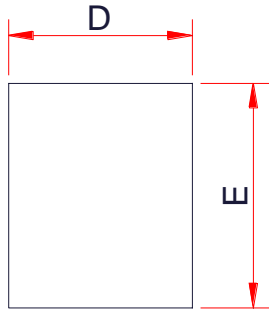
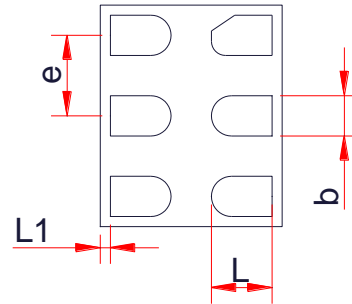
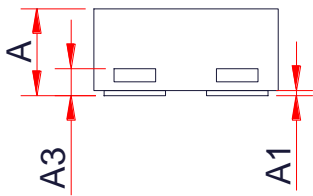
**Package Outline Dimensions**
**DFN1109-6L**

**TOP VIEW**

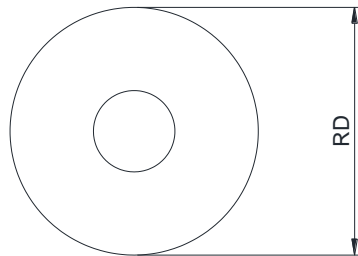
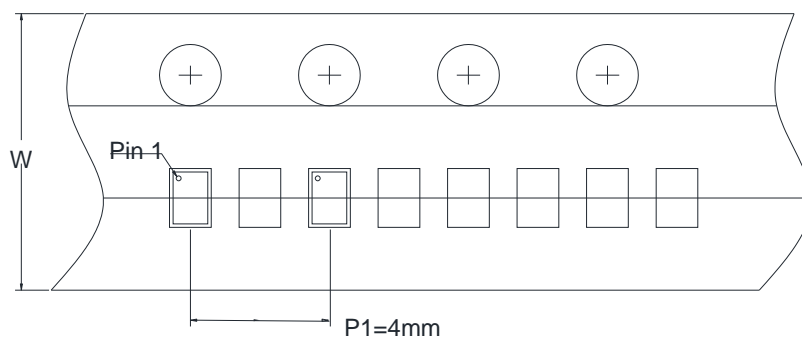
**BOTTOM VIEW**

**SIDE VIEW**

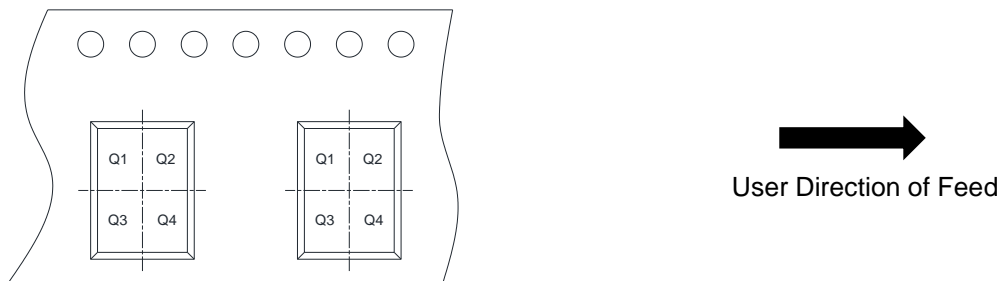
Symbol	Dimensions in Millimeters		
	Min.	Typ.	Max.
A	0.40	0.45	0.50
A1	0.00	0.02	0.05
A3	0.15 Ref.		
b	0.15	0.20	0.25
D	0.80	0.90	1.00
E	1.00	1.10	1.20
e	0.40 BSC		
L	0.22	-	0.35
L1	0.05 Ref.		

**Tape & Reel Dimensions**
**Reel Dimensions**

**Tape Dimensions**

**Note:** Tape material is plastic. Pitch between successive cavity centers is 2mm.

**Quadrant Assignments For PIN1 Orientation In Tape**

RD	Reel Dimension	<input checked="" type="checkbox"/> 7inch	<input type="checkbox"/> 13inch
W	Overall width of the carrier tape	<input checked="" type="checkbox"/> 8mm	<input type="checkbox"/> 12mm <input type="checkbox"/> 16mm
P1	Pitch between successive chip centers	<input type="checkbox"/> 2mm	<input checked="" type="checkbox"/> 4mm <input type="checkbox"/> 8mm
Pin1	Pin1 Quadrant	<input checked="" type="checkbox"/> Q1	<input type="checkbox"/> Q2 <input type="checkbox"/> Q3 <input type="checkbox"/> Q4