



Is Now Part of



ON Semiconductor®

To learn more about ON Semiconductor, please visit our website at
www.onsemi.com

Please note: As part of the Fairchild Semiconductor integration, some of the Fairchild orderable part numbers will need to change in order to meet ON Semiconductor's system requirements. Since the ON Semiconductor product management systems do not have the ability to manage part nomenclature that utilizes an underscore (_), the underscore (_) in the Fairchild part numbers will be changed to a dash (-). This document may contain device numbers with an underscore (_). Please check the ON Semiconductor website to verify the updated device numbers. The most current and up-to-date ordering information can be found at www.onsemi.com. Please email any questions regarding the system integration to Fairchild_questions@onsemi.com.

ON Semiconductor and the ON Semiconductor logo are trademarks of Semiconductor Components Industries, LLC dba ON Semiconductor or its subsidiaries in the United States and/or other countries. ON Semiconductor owns the rights to a number of patents, trademarks, copyrights, trade secrets, and other intellectual property. A listing of ON Semiconductor's product/patent coverage may be accessed at www.onsemi.com/site/pdf/Patent-Marking.pdf. ON Semiconductor reserves the right to make changes without further notice to any products herein. ON Semiconductor makes no warranty, representation or guarantee regarding the suitability of its products for any particular purpose, nor does ON Semiconductor assume any liability arising out of the application or use of any product or circuit, and specifically disclaims any and all liability, including without limitation special, consequential or incidental damages. Buyer is responsible for its products and applications using ON Semiconductor products, including compliance with all laws, regulations and safety requirements or standards, regardless of any support or applications information provided by ON Semiconductor. "Typical" parameters which may be provided in ON Semiconductor data sheets and/or specifications can and do vary in different applications and actual performance may vary over time. All operating parameters, including "Typicals" must be validated for each customer application by customer's technical experts. ON Semiconductor does not convey any license under its patent rights nor the rights of others. ON Semiconductor products are not designed, intended, or authorized for use as a critical component in life support systems or any FDA Class 3 medical devices or medical devices with a same or similar classification in a foreign jurisdiction or any devices intended for implantation in the human body. Should Buyer purchase or use ON Semiconductor products for any such unintended or unauthorized application, Buyer shall indemnify and hold ON Semiconductor and its officers, employees, subsidiaries, affiliates, and distributors harmless against all claims, costs, damages, and expenses, and reasonable attorney fees arising out of, directly or indirectly, any claim of personal injury or death associated with such unintended or unauthorized use, even if such claim alleges that ON Semiconductor was negligent regarding the design or manufacture of the part. ON Semiconductor is an Equal Opportunity/Affirmative Action Employer. This literature is subject to all applicable copyright laws and is not for resale in any manner.



October 2014

FDPC8012S

PowerTrench[®] Power Clip

25V Asymmetric Dual N-Channel MOSFET

Features

- Q1: N-Channel
 - Max $r_{DS(on)} = 7.0 \text{ m}\Omega$ at $V_{GS} = 4.5 \text{ V}$, $I_D = 12 \text{ A}$
- Q2: N-Channel
 - Max $r_{DS(on)} = 2.2 \text{ m}\Omega$ at $V_{GS} = 4.5 \text{ V}$, $I_D = 23 \text{ A}$
 - Low inductance packaging shortens rise/fall times, resulting in lower switching losses
 - MOSFET integration enables optimum layout for lower circuit inductance and reduced switch node ringing
 - RoHS Compliant



General Description

This device includes two specialized N-Channel MOSFETs in a dual package. The switch node has been internally connected to enable easy placement and routing of synchronous buck converters. The control MOSFET (Q1) and synchronous SyncFET[™] (Q2) have been designed to provide optimal power efficiency.

Applications

- Computing
- Communications
- General Purpose Point of Load

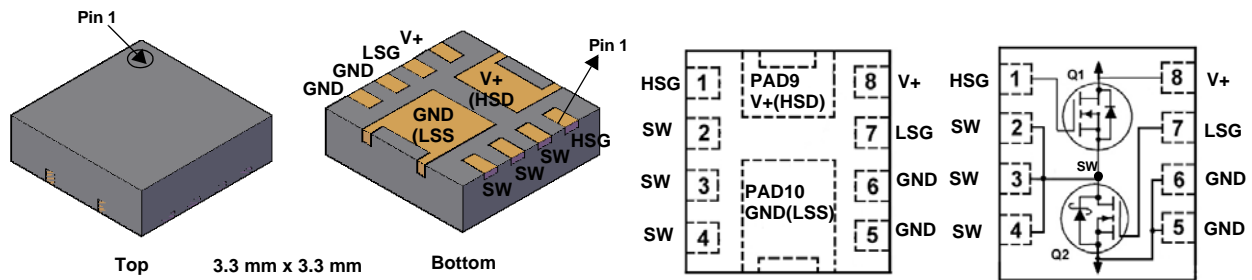

MOSFET Maximum Ratings $T_A = 25 \text{ }^\circ\text{C}$ unless otherwise noted

Symbol	Parameter	Q1	Q2	Units
V_{DS}	Drain to Source Voltage	25	25	V
V_{GS}	Gate to Source Voltage	12	12	V
I_D	Drain Current -Continuous	$T_C = 25 \text{ }^\circ\text{C}$	35	88
	-Continuous	$T_A = 25 \text{ }^\circ\text{C}$	13 ^{1a}	26 ^{1b}
	-Pulsed	(Note 4)	40	120
E_{AS}	Single Pulse Avalanche Energy	(Note 3)	50	181
P_D	Power Dissipation for Single Operation	$T_A = 25 \text{ }^\circ\text{C}$	1.6 ^{1a}	2.0 ^{1b}
	Power Dissipation for Single Operation	$T_A = 25 \text{ }^\circ\text{C}$	0.8 ^{1c}	0.9 ^{1d}
T_J, T_{STG}	Operating and Storage Junction Temperature Range	-55 to +150		$^\circ\text{C}$

Thermal Characteristics

$R_{\theta JA}$	Thermal Resistance, Junction to Ambient	77 ^{1a}	63 ^{1b}	$^\circ\text{C/W}$
$R_{\theta JA}$	Thermal Resistance, Junction to Ambient	151 ^{1c}	135 ^{1d}	
$R_{\theta JC}$	Thermal Resistance, Junction to Case	5.0	3.5	

Package Marking and Ordering Information

Device Marking	Device	Package	Reel Size	Tape Width	Quantity
01OD/03OD	FDPC8012S	Power Clip 33	13 "	12 mm	3000 units

Electrical Characteristics $T_J = 25\text{ }^\circ\text{C}$ unless otherwise noted

Symbol	Parameter	Test Conditions	Type	Min	Typ	Max	Units
--------	-----------	-----------------	------	-----	-----	-----	-------

Off Characteristics

BV_{DSS}	Drain to Source Breakdown Voltage	$I_D = 250\text{ }\mu\text{A}$, $V_{GS} = 0\text{ V}$ $I_D = 1\text{ mA}$, $V_{GS} = 0\text{ V}$	Q1 Q2	25 25			V
$\frac{\Delta BV_{DSS}}{\Delta T_J}$	Breakdown Voltage Temperature Coefficient	$I_D = 250\text{ }\mu\text{A}$, referenced to $25\text{ }^\circ\text{C}$ $I_D = 10\text{ mA}$, referenced to $25\text{ }^\circ\text{C}$	Q1 Q2		18 22		mV/ $^\circ\text{C}$
I_{DSS}	Zero Gate Voltage Drain Current	$V_{DS} = 20\text{ V}$, $V_{GS} = 0\text{ V}$ $V_{DS} = 20\text{ V}$, $V_{GS} = 0\text{ V}$	Q1 Q2			1 500	μA μA
I_{GSS}	Gate to Source Leakage Current, Forward	$V_{GS} = 12\text{ V/-8 V}$, $V_{DS} = 0\text{ V}$ $V_{GS} = 12\text{ V/-8 V}$, $V_{DS} = 0\text{ V}$	Q1 Q2			± 100 ± 100	nA nA

On Characteristics

$V_{GS(th)}$	Gate to Source Threshold Voltage	$V_{GS} = V_{DS}$, $I_D = 250\text{ }\mu\text{A}$ $V_{GS} = V_{DS}$, $I_D = 1\text{ mA}$	Q1 Q2	0.8 1.1	1.3 1.6	2.2 2.2	V
$\frac{\Delta V_{GS(th)}}{\Delta T_J}$	Gate to Source Threshold Voltage Temperature Coefficient	$I_D = 250\text{ }\mu\text{A}$, referenced to $25\text{ }^\circ\text{C}$ $I_D = 10\text{ mA}$, referenced to $25\text{ }^\circ\text{C}$	Q1 Q2		-4 -4		mV/ $^\circ\text{C}$
$r_{DS(on)}$	Drain to Source On Resistance	$V_{GS} = 4.5\text{ V}$, $I_D = 12\text{ A}$ $V_{GS} = 4.5\text{ V}$, $I_D = 12\text{ A}$, $T_J = 125\text{ }^\circ\text{C}$	Q1		5.2 7.5	7.0 10.5	m Ω
		$V_{GS} = 4.5\text{ V}$, $I_D = 23\text{ A}$ $V_{GS} = 4.5\text{ V}$, $I_D = 23\text{ A}$, $T_J = 125\text{ }^\circ\text{C}$	Q2		1.6 2.3	2.2 3.2	
g_{FS}	Forward Transconductance	$V_{DS} = 5\text{ V}$, $I_D = 13\text{ A}$ $V_{DS} = 5\text{ V}$, $I_D = 26\text{ A}$	Q1 Q2		79 200		S

Dynamic Characteristics

C_{iss}	Input Capacitance	Q1: $V_{DS} = 13\text{ V}$, $V_{GS} = 0\text{ V}$, $f = 1\text{ MHz}$	Q1 Q2		1075 3456		pF
C_{oss}	Output Capacitance	Q2: $V_{DS} = 13\text{ V}$, $V_{GS} = 0\text{ V}$, $f = 1\text{ MHz}$	Q1 Q2		250 885		pF
C_{riss}	Reverse Transfer Capacitance	$V_{DS} = 13\text{ V}$, $V_{GS} = 0\text{ V}$, $f = 1\text{ MHz}$	Q1 Q2		50 130		pF
R_g	Gate Resistance		Q1 Q2	0.1 0.1	0.4 0.5	2.0 2.0	Ω

Switching Characteristics

$t_{d(on)}$	Turn-On Delay Time		Q1 Q2		6 12		ns
t_r	Rise Time	Q1: $V_{DD} = 13\text{ V}$, $I_D = 13\text{ A}$, $R_{GEN} = 6\text{ }\Omega$	Q1 Q2		2 3		ns
$t_{d(off)}$	Turn-Off Delay Time	Q2: $V_{DD} = 13\text{ V}$, $I_D = 26\text{ A}$, $R_{GEN} = 6\text{ }\Omega$	Q1 Q2		19 34		ns
t_f	Fall Time		Q1 Q2		2 3		ns
Q_g	Total Gate Charge	$V_{GS} = 0\text{ V to }4.5\text{ V}$	Q1 Q2		8 25		nC
Q_{gs}	Gate to Source Gate Charge		Q1 Q2		2.3 7.8		nC
Q_{gd}	Gate to Drain "Miller" Charge		Q1 Q2		2.0 6.4		nC

Electrical Characteristics $T_J = 25\text{ }^\circ\text{C}$ unless otherwise noted

Symbol	Parameter	Test Conditions	Type	Min	Typ	Max	Units
--------	-----------	-----------------	------	-----	-----	-----	-------

Drain-Source Diode Characteristics

V_{SD}	Source to Drain Diode Forward Voltage	$V_{GS} = 0\text{ V}, I_S = 13\text{ A}$ (Note 2) $V_{GS} = 0\text{ V}, I_S = 26\text{ A}$ (Note 2)	Q1 Q2		0.8 0.8	1.2 1.2	V
t_{rr}	Reverse Recovery Time	Q1 $I_F = 13\text{ A}, di/dt = 100\text{ A}/\mu\text{s}$	Q1 Q2		20 27	35 43	ns
Q_{rr}	Reverse Recovery Charge	Q2 $I_F = 26\text{ A}, di/dt = 300\text{ A}/\mu\text{s}$	Q1 Q2		6 27	12 43	nC

Notes:

1. $R_{\theta JA}$ is determined with the device mounted on a 1 in² pad 2 oz copper pad on a 1.5 x 1.5 in. board of FR-4 material. $R_{\theta JC}$ is guaranteed by design while $R_{\theta CA}$ is determined by the user's board design.

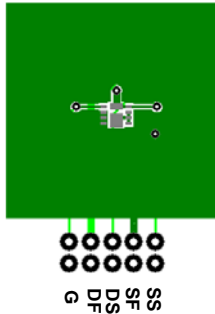

a. 77 °C/W when mounted on a 1 in² pad of 2 oz copper

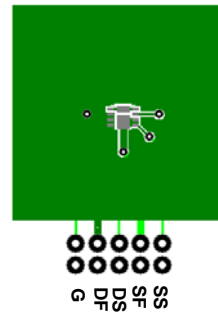

b. 63 °C/W when mounted on a 1 in² pad of 2 oz copper



c. 151 °C/W when mounted on a minimum pad of 2 oz copper



d. 135 °C/W when mounted on a minimum pad of 2 oz copper

2 Pulse Test: Pulse Width < 300 μs , Duty cycle < 2.0%.

3. Q1 : E_{AS} of 50 mJ is based on starting $T_J = 25\text{ }^\circ\text{C}$; N-ch: $L = 3\text{ mH}, I_{AS} = 5.8\text{ A}, V_{DD} = 25\text{ V}, V_{GS} = 10\text{ V}$. 100% test at $L = 0.1\text{ mH}, I_{AS} = 14.5\text{ A}$.

Q2: E_{AS} of 181 mJ is based on starting $T_J = 25\text{ }^\circ\text{C}$; N-ch: $L = 3\text{ mH}, I_{AS} = 11\text{ A}, V_{DD} = 25\text{ V}, V_{GS} = 10\text{ V}$. 100% test at $L = 0.1\text{ mH}, I_{AS} = 32.9\text{ A}$.

4. Pulsed Id limited by junction temperature, $t_d \leq 10\mu\text{s}$. Please refer to SOA curve for more details.

Typical Characteristics (Q1 N-Channel) $T_J = 25^\circ\text{C}$ unless otherwise noted

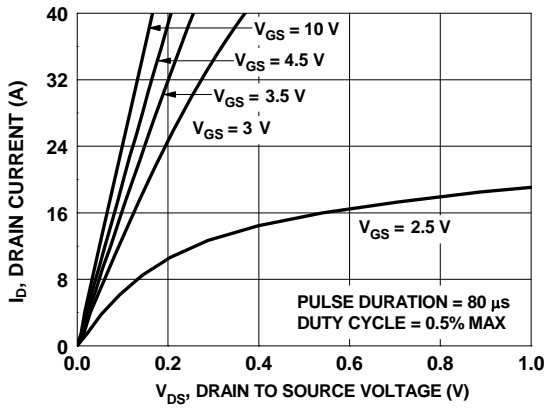

Figure 1. On Region Characteristics

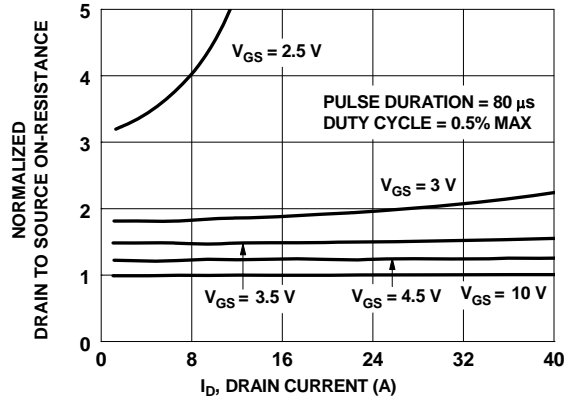

Figure 2. Normalized On-Resistance vs Drain Current and Gate Voltage

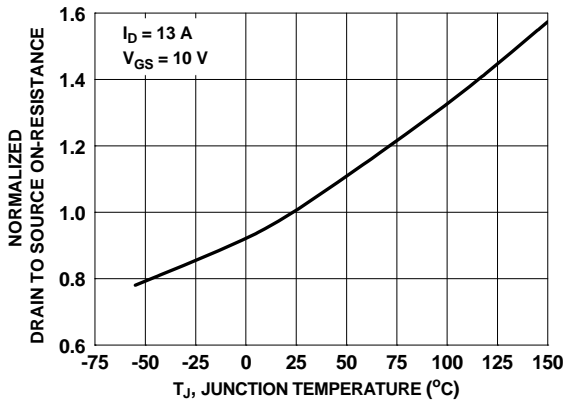

Figure 3. Normalized On Resistance vs Junction Temperature

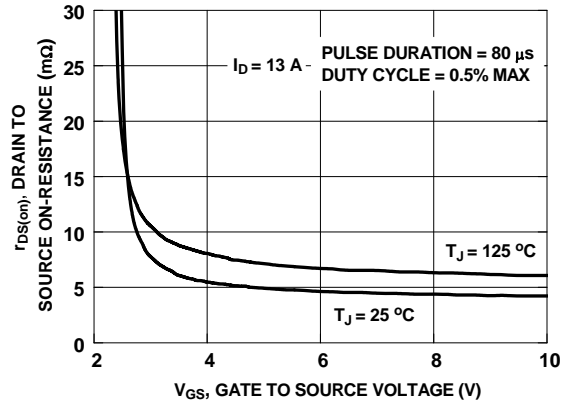

Figure 4. On-Resistance vs Gate to Source Voltage

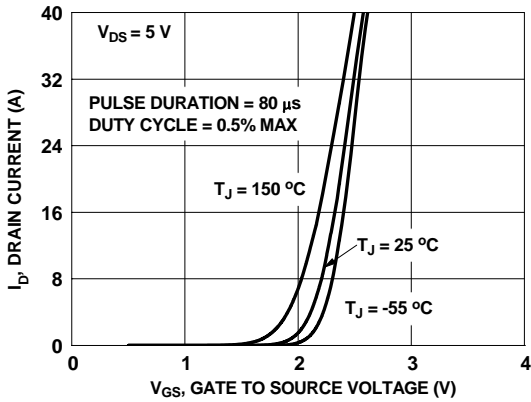

Figure 5. Transfer Characteristics

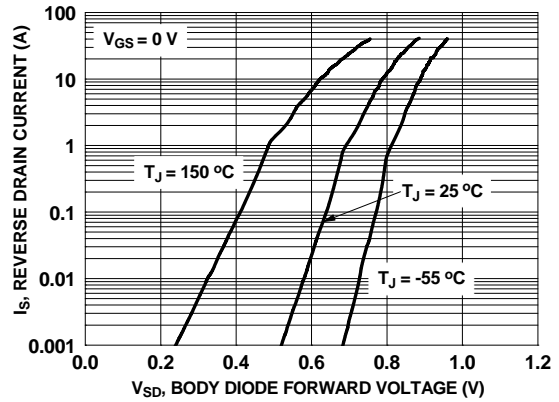

Figure 6. Source to Drain Diode Forward Voltage vs Source Current

Typical Characteristics (Q1 N-Channel) $T_J = 25^\circ\text{C}$ unless otherwise noted

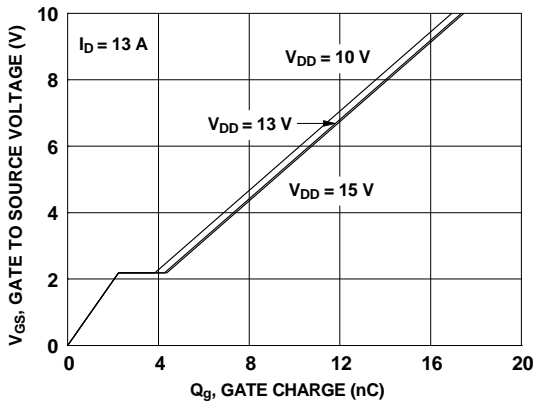

Figure 7. Gate Charge Characteristics

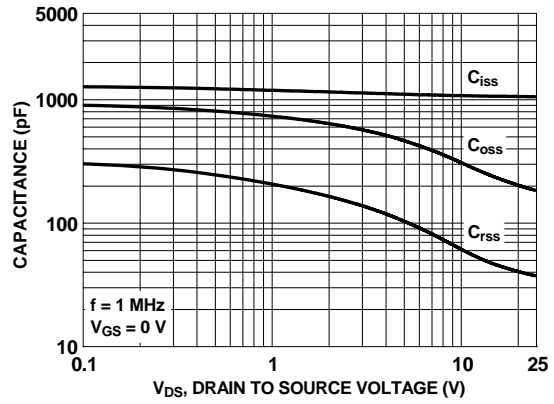

Figure 8. Capacitance vs Drain to Source Voltage

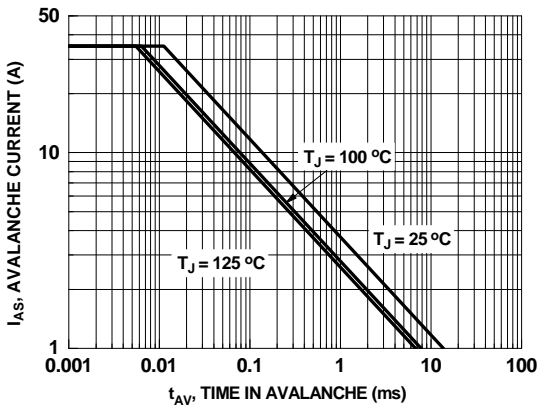

Figure 9. Unclamped Inductive Switching Capability

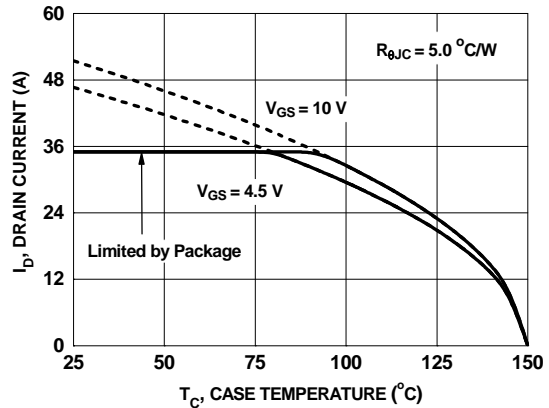

Figure 10. Maximum Continuous Drain Current vs Case Temperature

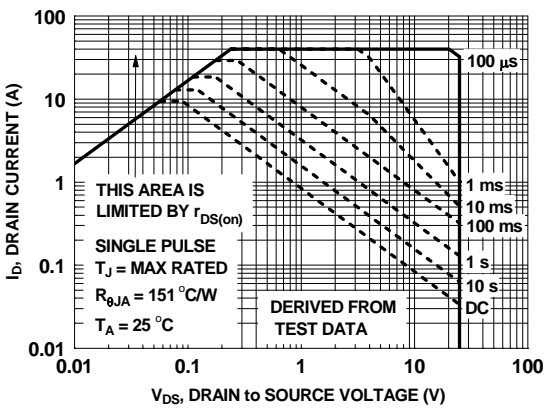

Figure 11. Forward Bias Safe Operating Area

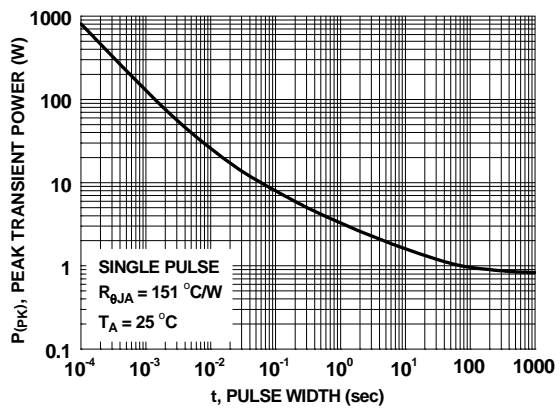

Figure 12. Single Pulse Maximum Power Dissipation

Typical Characteristics (Q1 N-Channel) $T_J = 25^\circ\text{C}$ unless otherwise noted

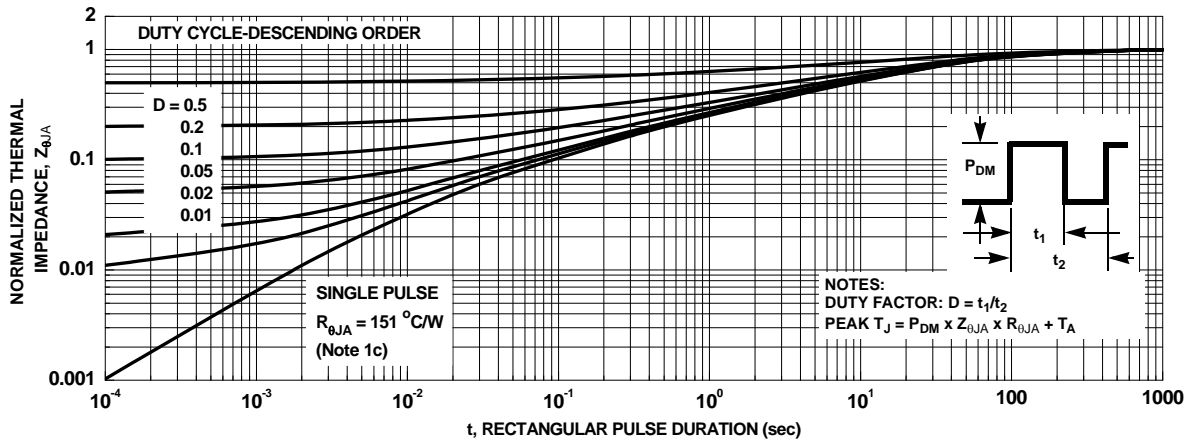

Figure 13. Junction-to-Ambient Transient Thermal Response Curve

Typical Characteristics (Q2 N-Channel) $T_J = 25\text{ }^\circ\text{C}$ unless otherwise noted

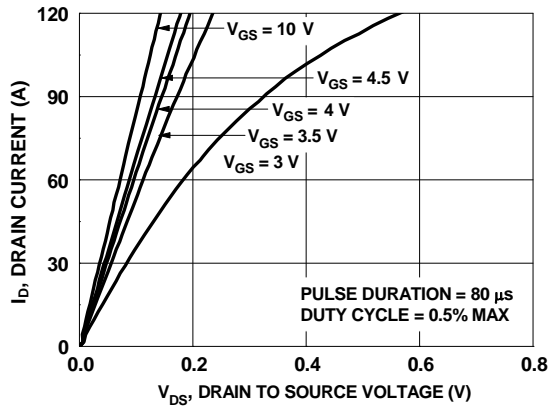

Figure 14. On-Region Characteristics

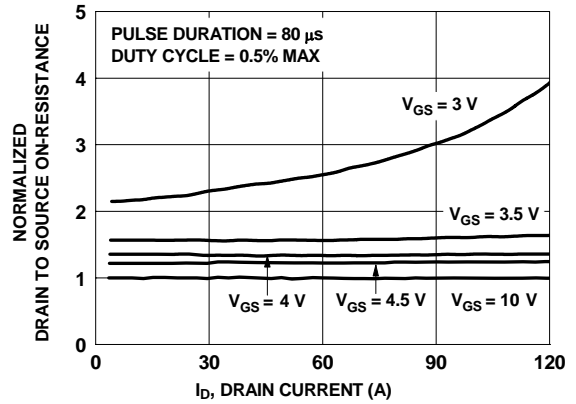

Figure 15. Normalized on-Resistance vs Drain Current and Gate Voltage

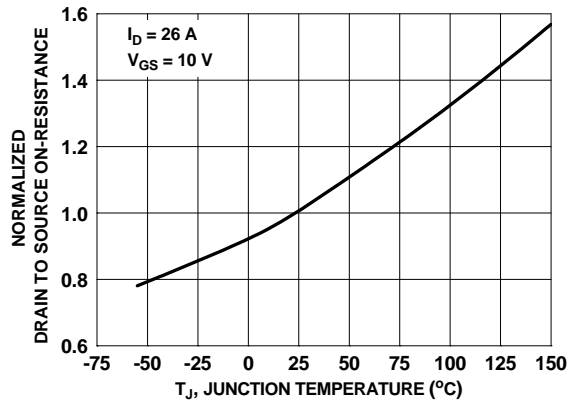

Figure 16. Normalized On-Resistance vs Junction Temperature

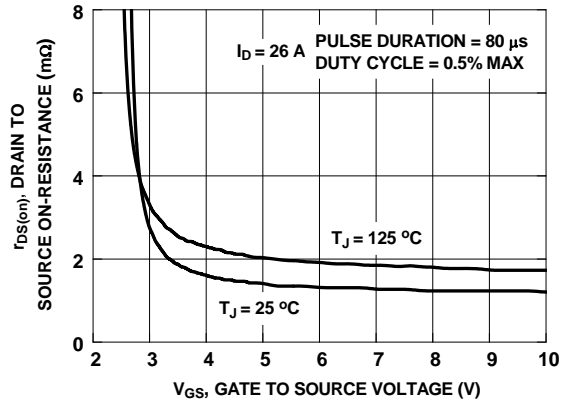

Figure 17. On-Resistance vs Gate to Source Voltage

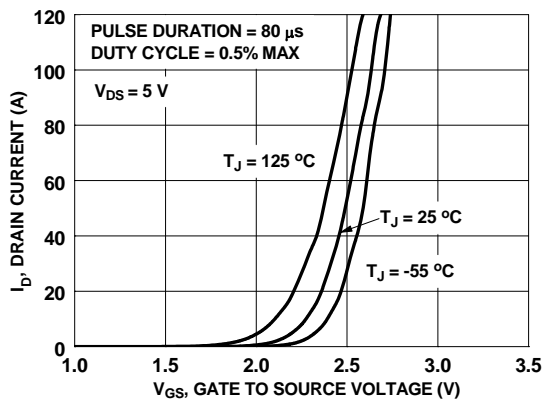

Figure 18. Transfer Characteristics

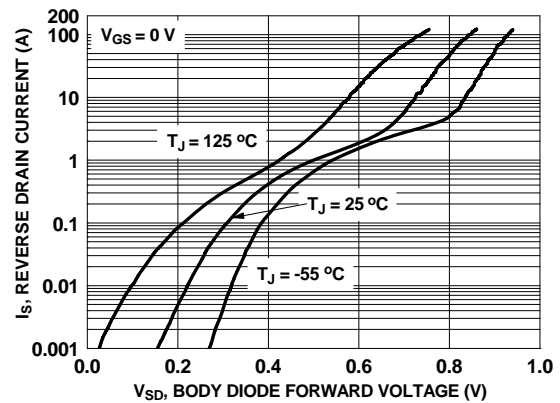

Figure 19. Source to Drain Diode Forward Voltage vs Source Current

Typical Characteristics (Q2 N-Channel) $T_J = 25^\circ\text{C}$ unless otherwise noted

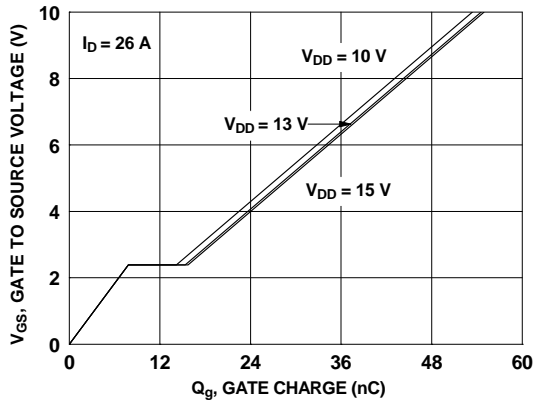

Figure 20. Gate Charge Characteristics

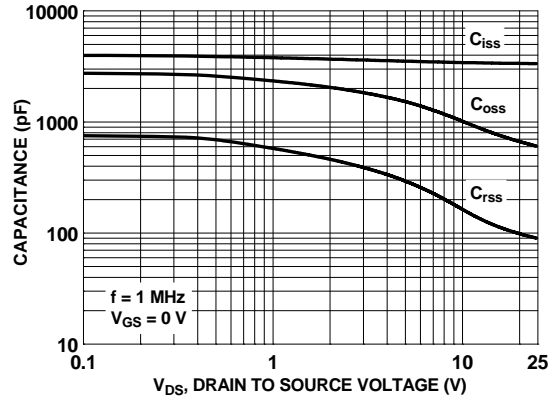

Figure 21. Capacitance vs Drain to Source Voltage

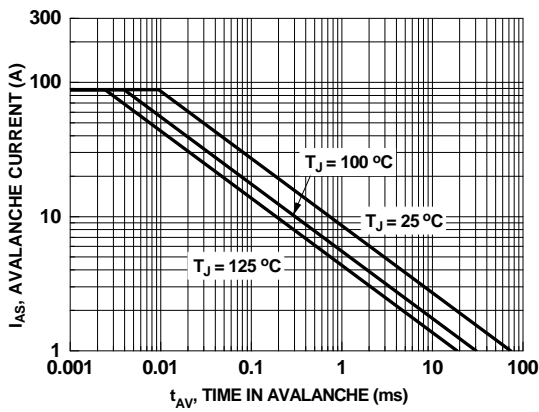

Figure 22. Unclamped Inductive Switching Capability

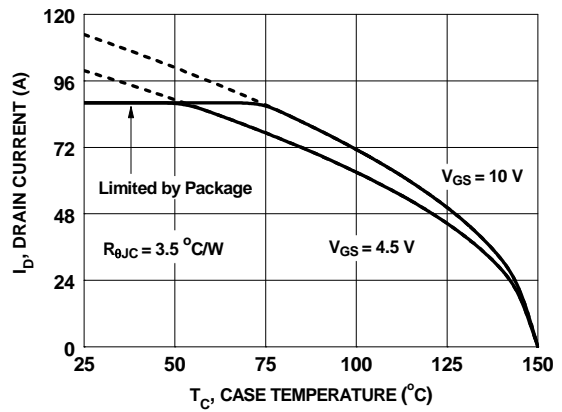

Figure 23. Maximum Continuous Drain Current vs Case Temperature

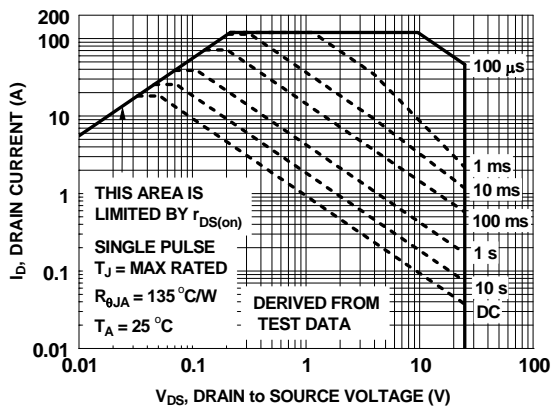

Figure 24. Forward Bias Safe Operating Area

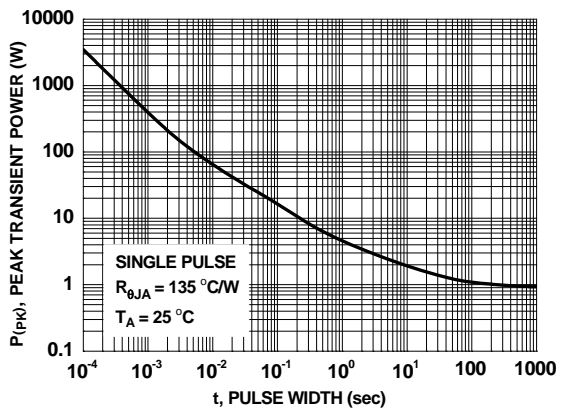

Figure 25. Single Pulse Maximum Power Dissipation

Typical Characteristics (Q2 N-Channel) $T_J = 25\text{ }^\circ\text{C}$ unless otherwise noted

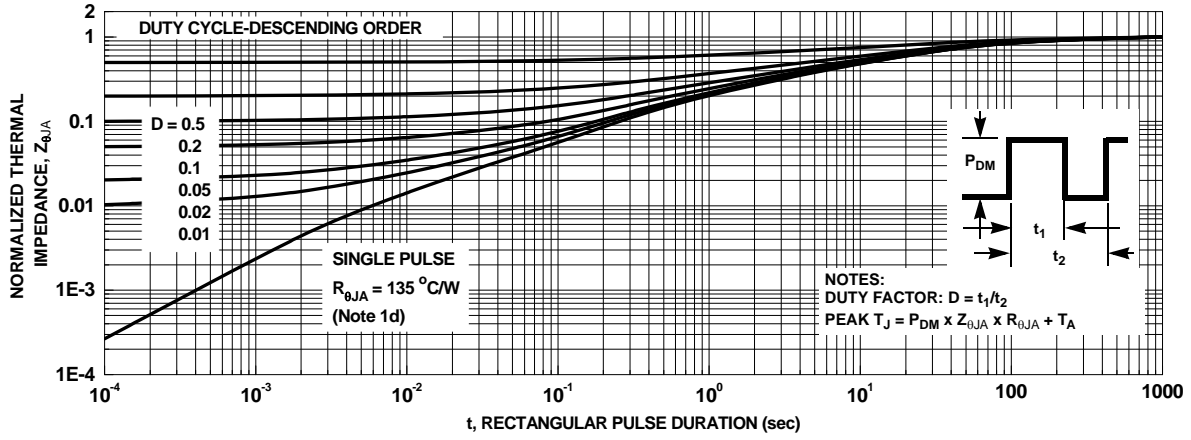

Figure 26. Junction-to-Ambient Transient Thermal Response Curve

Typical Characteristics (continued)

SyncFET™ Schottky body diode Characteristics

Fairchild's SyncFET™ process embeds a Schottky diode in parallel with PowerTrench MOSFET. This diode exhibits similar characteristics to a discrete external Schottky diode in parallel with a MOSFET. Figure 27 shows the reverse recovery characteristic of the FDPC8012S.

Schottky barrier diodes exhibit significant leakage at high temperature and high reverse voltage. This will increase the power in the device.

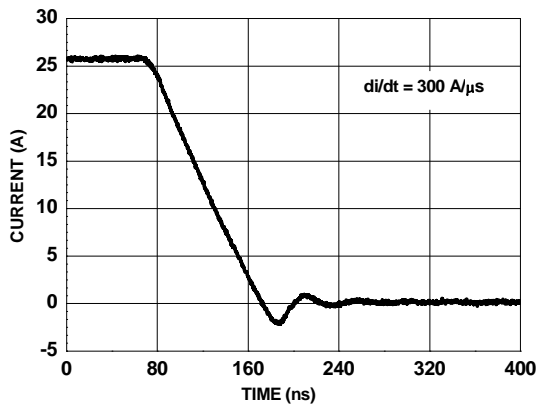

Figure 27. FDPC8012S SyncFET™ body diode reverse recovery characteristic

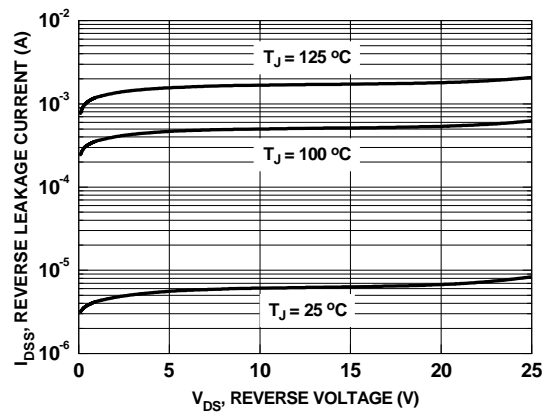

Figure 28. SyncFET™ body diode reverse leakage versus drain-source voltage

Application Information

Typical Application Diagram (Synchronous Rectifier Buck Converter)

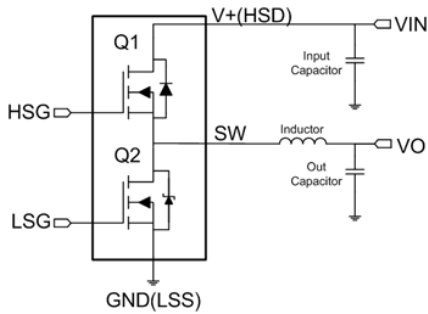

Figure 1. Power Clip in Buck Converter Topology

As shown in Figure 1, in the Power Clip package Q1 is the High Side MOSFET (Control MOSFET) and Q2 is the Low Side MOSFET (Synchronous MOSFET). Figure 2 below shows the package pin out. The blue overlay on the drawing indicates a typical PCB land pattern for the part.

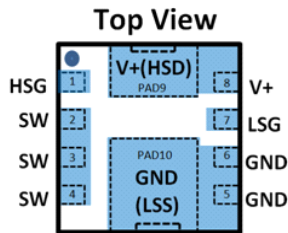

Figure 2. Top View of Power Clip

Table 1 Pin Information shows the name and description of each pin.

PIN		Description
Number	Name	
1	HSG	Gate signal input of Q1 Gate
2,3,4	SW	Switch or Phase node, Source of Q1 and Drain of Q2
5,6,PAD 10	GND,GND(LSS) PAD	Ground, Source of Q2
7	LSG	Gate signal input of Q2 Gate
8,PAD 9	V+, V+(HSD) PAD	Input voltage of SR Buck converter, Drain of Q1

Table 1. Pin Information

Recommended PCB Layout Guidelines

As a PCB designer, it is necessary to address critical issues in layout to minimize losses and optimize the performance of the power train. Power Clip is a high power density solution and all high current flow paths, such as V+(HSD), SW and GND(LSS) should be short and wide for minimal resistance and inductance. V+(HSD) and GND(LSS) are the primary heat flow paths for the Power Clip. A recommended layout procedure is discussed below to maximize the electrical and thermal performance of the part.

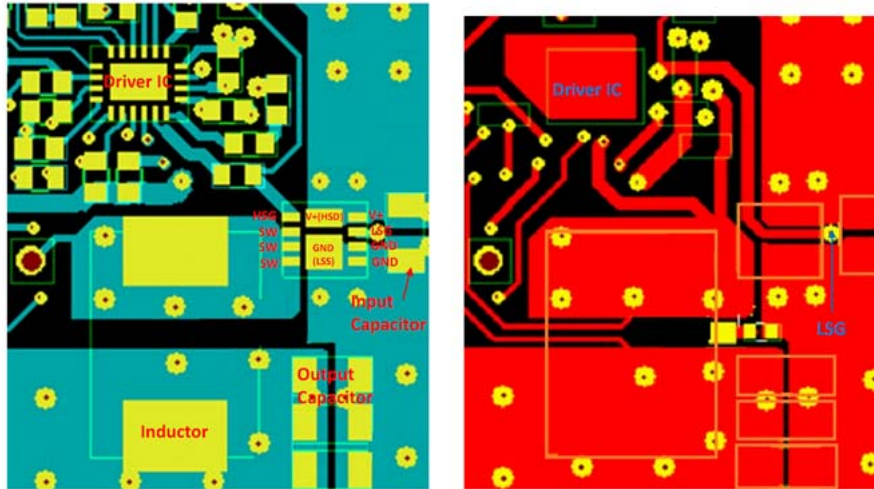

Figure 3. Top/Component (green) View and Bottom (red) PCB View

Following is a guideline, not a requirement which the PCB designer should consider.

Figure 3 shows an example of a well designed layout. The discussion that follows summarizes the key features of this layout.

- "The input ceramic bypass capacitor between VIN and GND should be placed as close as possible to the pins V+ / V+(HSD) PAD and GND / GND(LSS) PAD to help reduce parasitic inductance and high frequency ringing. Several capacitors may be placed in parallel, and capacitors may be placed on both the top and bottom side of the board. The capacitor located immediately adjacent to the Power Clip will be the most effective at reducing HF parasitic. Caps located farther away, or on the opposite side of the board will also assist, but will be less effective due to increased trace inductance.
- "The Power Clip package design, with very short distance between pins V+ and GND, allows for a short connect distance to the input cap. This is a factor that enables the Power Clip switch loop to have very low parasitic inductance.
- "Use large copper areas on the component side to connect the V+ pin and V+ (HSD) pad, and the GND and GND(LSS) PAD.
- "The SW to inductor copper trace is a high current path. It will also be a high noise region due to switching voltage transients. The trace should be short and wide to enable a low resistance path and to minimize the size of the noise region. Care should be taken to minimize coupling of this trace to adjacent traces. The layout in Figure 3 shows a good example of this short, wide path.
- "The Power Trench® Technology MOSFETs used in the Power Clip are effective at minimizing SW node ringing. They incorporate a proprietary design¹ that minimizes the peak overshoot ring voltage on the switch node (SW). They allow the part to operate well within the breakdown voltage limits. For most layouts, this eliminates the need to add an external snubber circuit. If the designer chooses to use an RC snubber, it should be placed close to the part between the SW pins and GND / GND (LSS) PAD to dampen the high frequency ringing.
- "The Driver IC should be placed relatively closed to HSG pin and LSG pin to minimize G drive trace inductance. Excessive G trace length may slow the switching speed of the HS drive. And it may lead to excessive ringing on the LS G. If the designer must place the driver a significant distance away from the Power Clip, it would be a good practice to include a 0 Ohm resistor in the LS G path as a place holder. In the final design, if the LS G exhibits excessive LF ringing, efficiency can often be improved by changing this resistor to a few Ohms to dampen the LS G LF ringing.
- "The Power Clip has very good Junction-PCB heat transfer from all power pins. It has much better heat transfer Junction-GND (LSS) than traditional dual FET packages. In most cases, board ground will be the most effective heat transfer path on the PCB. Use a large copper area between GND / GND(LSS) PAD pins and board ground. To ensure the best thermal and electrical connection to ground, we recommend using multiple vias to interconnect ground plane layers as shown in Figure 3.

1. Patent Pending

- "Use multiple vias in parallel on each copper region to interconnect top, inner and bottom layers. This will reduce resistance and inductance of the vias and will improve thermal conductivity. Vias should be relatively large, around 8 mils to 10 mils.
- "Avoid using narrow thermal relief traces on the V+ / V+(HSD) PAD and GND / GND(LSS)PAD pins. These will increase HF switch loop inductance. And these will increase ringing of the HF power loop and the SW node.

Dimensional Outline and Pad Layout

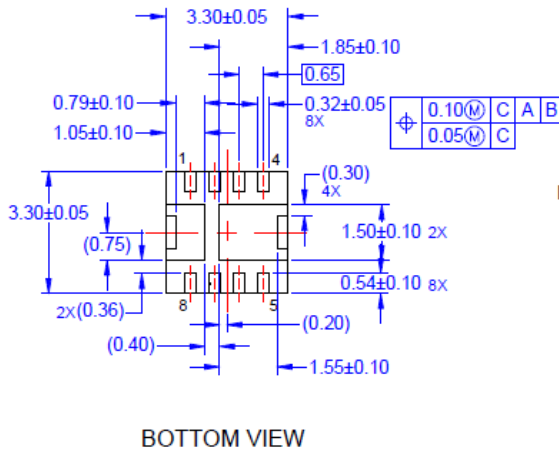
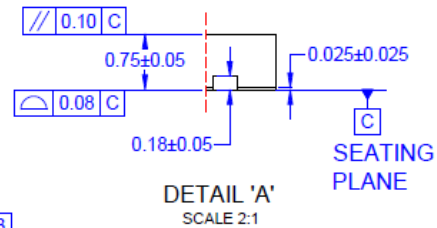
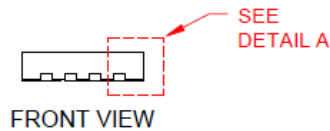
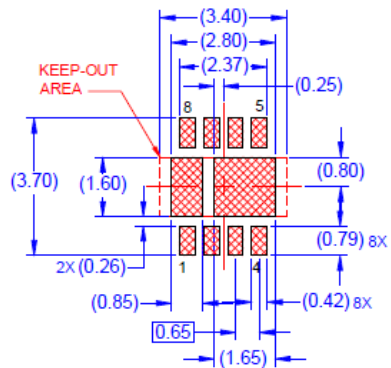
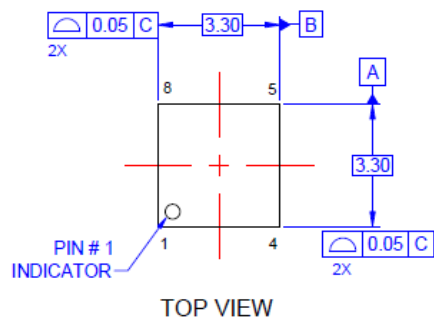

- NOTES: UNLESS OTHERWISE SPECIFIED
- A) THIS PACKAGE IS REFERENCED FROM JEDEC MO-240, VARIATION BA.
 - B) ALL DIMENSIONS ARE IN MILLIMETERS.
 - C) DIMENSIONS DO NOT INCLUDE BURRS OR MOLD FLASH. MOLD FLASH OR BURRS DOES NOT EXCEED 0.10MM.
 - D) DIMENSIONING AND TOLERANCING PER ASME Y14.5M-2009.
 - E) IT IS RECOMMENDED TO HAVE NO TRACES OR VIAS WITHIN THE KEEP OUT AREA.
 - F) DRAWING FILE NAME: MKT-PQFN08GREV4



Package drawings are provided as a service to customers considering Fairchild components. Drawings may change in any manner without notice. Please note the revision and/or date on the drawing and contact a Fairchild Semiconductor representative to verify or obtain the most recent revision. Package specifications do not expand the terms of Fairchild's worldwide terms and conditions, specifically the warranty therein, which covers Fairchild products.

Always visit Fairchild Semiconductor's online packaging area for the most recent package drawings:
https://www.fairchildsemi.com/evaluate/package-specifications/packageDetails.html?id=PN_PQDEU-X08.



TRADEMARKS

The following includes registered and unregistered trademarks and service marks, owned by Fairchild Semiconductor and/or its global subsidiaries, and is not intended to be an exhaustive list of all such trademarks.

- | | | | |
|--|---|---------------------------------------|------------------|
| AccuPower™ | F-PFET™ | PowerTrench® | SYSTEM GENERAL® |
| Awinda® | FRFET® | PowerXS™ | TinyBoost® |
| AX-CAP®* | Global Power Resource™ | Programmable Active Droop™ | TinyBuck® |
| BitSiC™ | GreenBridge™ | QFET® | TinyCalc™ |
| Build it Now™ | Green FPS™ | QS™ | TinyLogic® |
| CorePLUS™ | Green FPS™ e-Series™ | Quiet Series™ | TINYOPTO™ |
| CorePOWER™ | Gmax™ | RapidConfigure™ | TinyPower™ |
| CROSSVOLT™ | GTO™ | SM™ | TinyPWM™ |
| CTL™ | IntelliMAX™ | Saving our world, 1mW/W/kW at a time™ | TinyWire™ |
| Current Transfer Logic™ | ISOPLANAR™ | SignalWise™ | TranSiC™ |
| DEUXPEED® | Marking Small Speakers Sound Louder and Better™ | SmartMax™ | TriFault Detect™ |
| Dual Cool™ | MegaBuck™ | SMART START™ | TRUECURRENT®* |
| EcoSPARK® | MICROCOUPLER™ | Solutions for Your Success™ | µSerDes™ |
| EfficientMax™ | MicroFET™ | SPM® | UHC® |
| ESBC™ | MicroPak™ | STEALTH™ | Ultra FRFET® |
|  Fairchild® | MicroPak2™ | SuperFET® | UniFET™ |
| Fairchild Semiconductor® | MillerDrive™ | SuperSOT™-3 | VCX™ |
| FACT Quiet Series™ | MotionMax™ | SuperSOT™-6 | VisualMax™ |
| FACT® | MotionGrid® | SuperSOT™-8 | VoltagePlus™ |
| FAST® | MTi® | SupreMOS® | XST™ |
| FastvCore™ | MTx® | SyncFET™ | Xsens™ |
| FETBench™ | MVN® | Sync-Lock™ | 仙童™ |
| FPS™ | mWSaver® | | |
| | OptoHit™ | | |

*Trademarks of System General Corporation, used under license by Fairchild Semiconductor.

DISCLAIMER

FAIRCHILD SEMICONDUCTOR RESERVES THE RIGHT TO MAKE CHANGES WITHOUT FURTHER NOTICE TO ANY PRODUCTS HEREIN TO IMPROVE RELIABILITY, FUNCTION, OR DESIGN. TO OBTAIN THE LATEST, MOST UP-TO-DATE DATASHEET AND PRODUCT INFORMATION, VISIT OUR WEBSITE AT [HTTP://WWW.FAIRCHILDSEMI.COM](http://www.fairchildsemi.com). FAIRCHILD DOES NOT ASSUME ANY LIABILITY ARISING OUT OF THE APPLICATION OR USE OF ANY PRODUCT OR CIRCUIT DESCRIBED HEREIN; NEITHER DOES IT CONVEY ANY LICENSE UNDER ITS PATENT RIGHTS, NOR THE RIGHTS OF OTHERS. THESE SPECIFICATIONS DO NOT EXPAND THE TERMS OF FAIRCHILD'S WORLDWIDE TERMS AND CONDITIONS, SPECIFICALLY THE WARRANTY THEREIN, WHICH COVERS THESE PRODUCTS.

LIFE SUPPORT POLICY

FAIRCHILD'S PRODUCTS ARE NOT AUTHORIZED FOR USE AS CRITICAL COMPONENTS IN LIFE SUPPORT DEVICES OR SYSTEMS WITHOUT THE EXPRESS WRITTEN APPROVAL OF FAIRCHILD SEMICONDUCTOR CORPORATION.

As used here in:

1. Life support devices or systems are devices or systems which, (a) are intended for surgical implant into the body or (b) support or sustain life, and (c) whose failure to perform when properly used in accordance with instructions for use provided in the labeling, can be reasonably expected to result in a significant injury of the user.
2. A critical component in any component of a life support, device, or system whose failure to perform can be reasonably expected to cause the failure of the life support device or system, or to affect its safety or effectiveness.

ANTI-COUNTERFEITING POLICY

Fairchild Semiconductor Corporation's Anti-Counterfeiting Policy. Fairchild's Anti-Counterfeiting Policy is also stated on our external website, www.fairchildsemi.com, under Sales Support.

Counterfeiting of semiconductor parts is a growing problem in the industry. All manufactures of semiconductor products are experiencing counterfeiting of their parts. Customers who inadvertently purchase counterfeit parts experience many problems such as loss of brand reputation, substandard performance, failed application, and increased cost of production and manufacturing delays. Fairchild is taking strong measures to protect ourselves and our customers from the proliferation of counterfeit parts. Fairchild strongly encourages customers to purchase Fairchild parts either directly from Fairchild or from Authorized Fairchild Distributors who are listed by country on our web page cited above. Products customers buy either from Fairchild directly or from Authorized Fairchild Distributors are genuine parts, have full traceability, meet Fairchild's quality standards for handling and storage and provide access to Fairchild's full range of up-to-date technical and product information. Fairchild and our Authorized Distributors will stand behind all warranties and will appropriately address and warranty issues that may arise. Fairchild will not provide any warranty coverage or other assistance for parts bought from Unauthorized Sources. Fairchild is committed to combat this global problem and encourage our customers to do their part in stopping this practice by buying direct or from authorized distributors.

PRODUCT STATUS DEFINITIONS

Definition of Terms

Datasheet Identification	Product Status	Definition
Advance Information	Formative / In Design	Datasheet contains the design specifications for product development. Specifications may change in any manner without notice.
Preliminary	First Production	Datasheet contains preliminary data; supplementary data will be published at a later date. Fairchild Semiconductor reserves the right to make changes at any time without notice to improve design.
No Identification Needed	Full Production	Datasheet contains final specifications. Fairchild Semiconductor reserves the right to make changes at any time without notice to improve the design.
Obsolete	Not In Production	Datasheet contains specifications on a product that is discontinued by Fairchild Semiconductor. The datasheet is for reference information only.

Rev. I71

ON Semiconductor and  are trademarks of Semiconductor Components Industries, LLC dba ON Semiconductor or its subsidiaries in the United States and/or other countries. ON Semiconductor owns the rights to a number of patents, trademarks, copyrights, trade secrets, and other intellectual property. A listing of ON Semiconductor's product/patent coverage may be accessed at www.onsemi.com/site/pdf/Patent-Marking.pdf. ON Semiconductor reserves the right to make changes without further notice to any products herein. ON Semiconductor makes no warranty, representation or guarantee regarding the suitability of its products for any particular purpose, nor does ON Semiconductor assume any liability arising out of the application or use of any product or circuit, and specifically disclaims any and all liability, including without limitation special, consequential or incidental damages. Buyer is responsible for its products and applications using ON Semiconductor products, including compliance with all laws, regulations and safety requirements or standards, regardless of any support or applications information provided by ON Semiconductor. "Typical" parameters which may be provided in ON Semiconductor data sheets and/or specifications can and do vary in different applications and actual performance may vary over time. All operating parameters, including "Typicals" must be validated for each customer application by customer's technical experts. ON Semiconductor does not convey any license under its patent rights nor the rights of others. ON Semiconductor products are not designed, intended, or authorized for use as a critical component in life support systems or any FDA Class 3 medical devices or medical devices with a same or similar classification in a foreign jurisdiction or any devices intended for implantation in the human body. Should Buyer purchase or use ON Semiconductor products for any such unintended or unauthorized application, Buyer shall indemnify and hold ON Semiconductor and its officers, employees, subsidiaries, affiliates, and distributors harmless against all claims, costs, damages, and expenses, and reasonable attorney fees arising out of, directly or indirectly, any claim of personal injury or death associated with such unintended or unauthorized use, even if such claim alleges that ON Semiconductor was negligent regarding the design or manufacture of the part. ON Semiconductor is an Equal Opportunity/Affirmative Action Employer. This literature is subject to all applicable copyright laws and is not for resale in any manner.

PUBLICATION ORDERING INFORMATION

LITERATURE FULFILLMENT:

Literature Distribution Center for ON Semiconductor
19521 E. 32nd Pkwy, Aurora, Colorado 80011 USA
Phone: 303-675-2175 or 800-344-3860 Toll Free USA/Canada
Fax: 303-675-2176 or 800-344-3867 Toll Free USA/Canada
Email: orderlit@onsemi.com

N. American Technical Support: 800-282-9855 Toll Free
USA/Canada
Europe, Middle East and Africa Technical Support:
Phone: 421 33 790 2910
Japan Customer Focus Center
Phone: 81-3-5817-1050

ON Semiconductor Website: www.onsemi.com
Order Literature: <http://www.onsemi.com/orderlit>
For additional information, please contact your local
Sales Representative