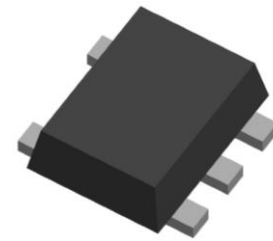
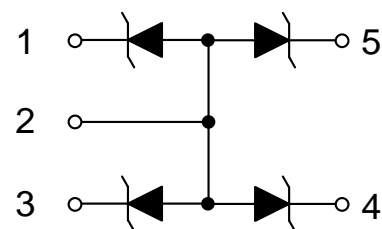
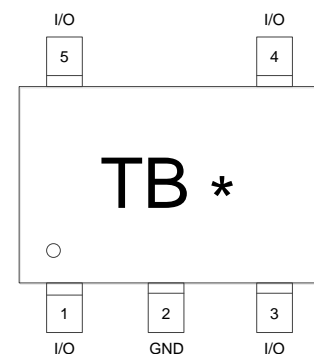

**ESDA6V8V5**
**4-Lines, Uni-directional, Transient Voltage Suppressor**
<http://www.sh-willsemi.com>
**Descriptions**

The ESDA6V8V5 array is 4-line ESD transient voltage suppressor which provides a very high level of protection for sensitive electronic components that may be subjected to electrostatic discharge (ESD). These devices clamp the voltage just above the logic level supply for positive transient and to a diode drop below ground for negative transient.

The ESDA6V8V5 may be used to provide ESD protection up to  $\pm 30\text{kV}$  (contact discharge) according to IEC61000-4-2, and withstand peak pulse current up to 8A (8/20 $\mu\text{s}$ ) according to IEC61000-4-5.

The ESDA6V8V5 is available in SOT-553 package. Standard products are Pb-free and Halogen-free.

**SOT-553**

**Circuit diagram**

TB = Device code

\* = Date code

**Marking & Pin configuration**
**Features**

- Reverse stand-off voltage: 5V max.
- Transient protection for each line according to IEC61000-4-2 (ESD):  $\pm 30\text{kV}$  (contact discharge)  
IEC61000-4-5 (surge): 8A (8/20 $\mu\text{s}$ )
- Capacitance:  $C_j = 55\text{pF}$  typ.
- Low leakage current
- Low clamping voltage
- Solid-state silicon technology

**Applications**

- Cell Phone Handsets and Accessories
- Personal Digital Assistants
- Notebooks, Desktops, and Servers
- Portable Instrument

**Order information**

Device	Package	Shipping
ESDA6V8V5-5/TR	SOT-553	3000/Tape&Reel

**Absolute maximum ratings**

Parameter	Symbol	Rating	Unit
Peak pulse power ( $t_p = 8/20\mu s$ )	$P_{pk}$	96	W
Peak pulse current ( $t_p = 8/20\mu s$ )	$I_{PP}$	8	A
ESD according to IEC61000-4-2 air discharge	$V_{ESD}$	$\pm 30$	kV
ESD according to IEC61000-4-2 contact discharge		$\pm 30$	
Junction temperature	$T_J$	125	$^{\circ}C$
Operation temperature	$T_{OP}$	-40~85	$^{\circ}C$
Lead temperature	$T_L$	260	$^{\circ}C$
Storage temperature	$T_{STG}$	-55~150	$^{\circ}C$

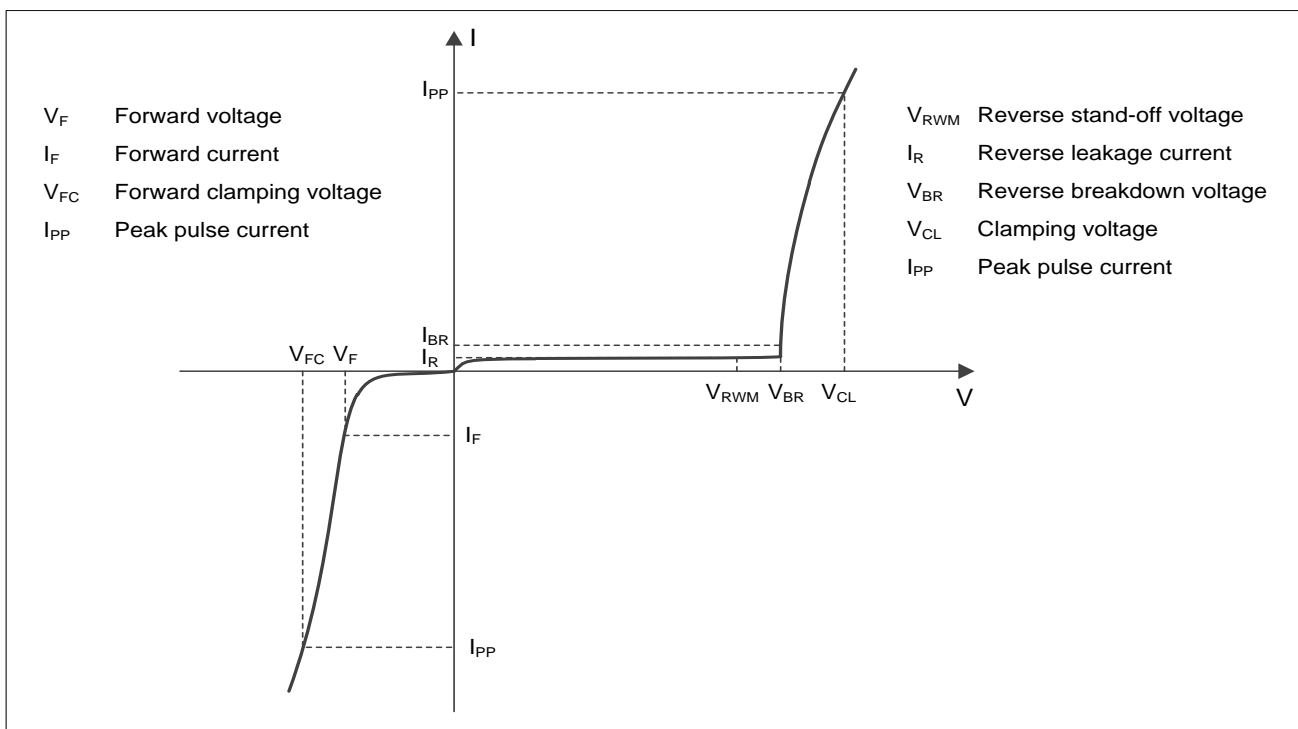
**Electrical characteristics ( $T_A = 25^{\circ}C$ , unless otherwise noted)**

**Definitions of electrical characteristics**

**Electrical characteristics ( $T_A = 25^\circ\text{C}$ , unless otherwise noted)**

Parameter	Symbol	Condition	Min.	Typ.	Max.	Unit
Reverse stand-off voltage	$V_{RWM}$				5.0	V
Reverse leakage current	$I_R$	$V_{RWM} = 5\text{V}$			1	$\mu\text{A}$
Reverse breakdown voltage	$V_{BR}$	$I_{BR} = 1\text{mA}$	6.2		8.2	V
Forward voltage	$V_F$	$I_F = 10\text{mA}$	0.4	0.8	1.25	V
Clamping voltage <sup>1)</sup>	$V_{CL}$	$I_{PP} = 16\text{A}$ , $t_p = 100\text{ns}$		11		V
Clamping voltage <sup>2)</sup>	$V_{CL}$	$V_{ESD} = +8\text{kV}$		11		V
Dynamic resistance <sup>1)</sup>	$R_{DYN}$			0.25		$\Omega$
Clamping voltage <sup>3)</sup>	$V_{CL}$	$I_{PP} = 1\text{A}$ , $t_p = 8/20\mu\text{s}$			9	V
		$I_{PP} = 8\text{A}$ , $t_p = 8/20\mu\text{s}$			12	V
Junction capacitance	$C_J$	$V_R = 0\text{V}$ , $f = 1\text{MHz}$		55	65	pF

**Notes:**

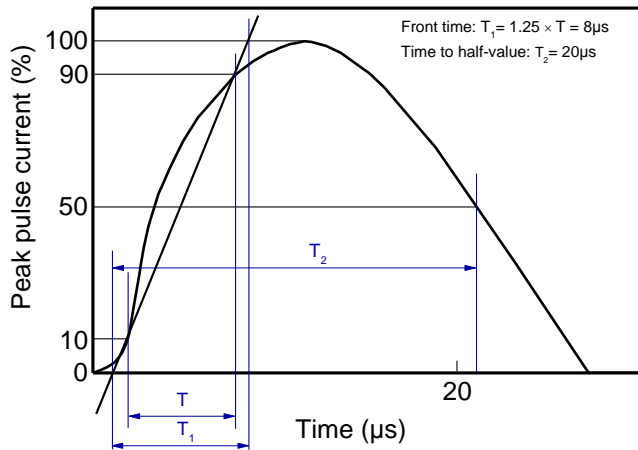
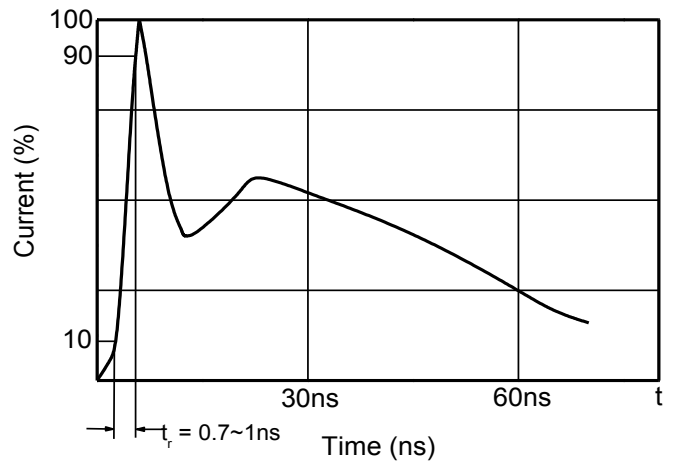
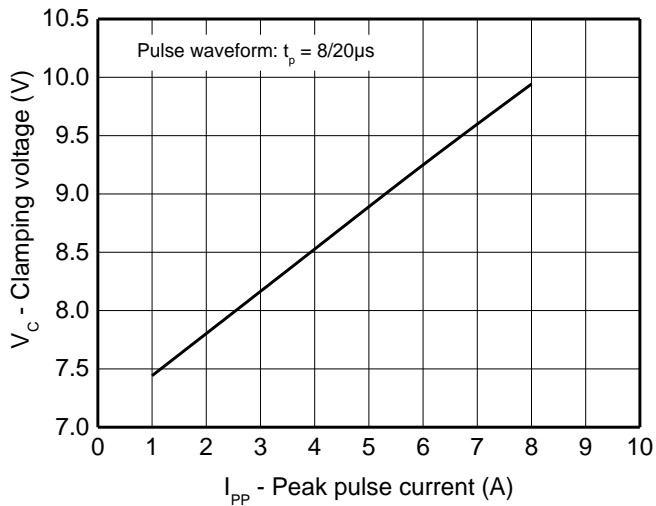
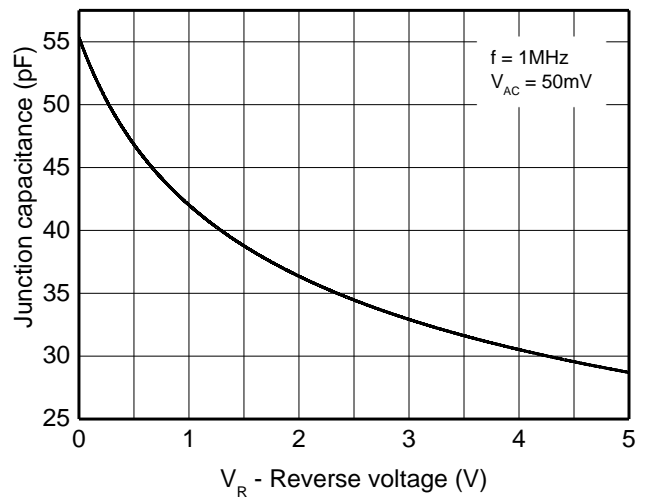
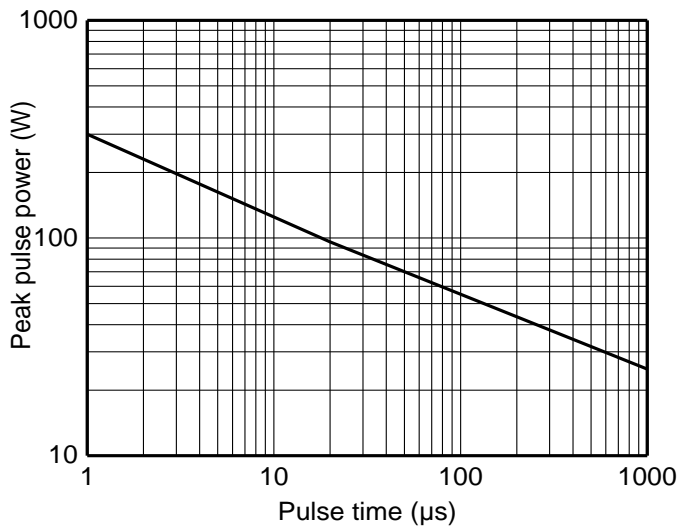
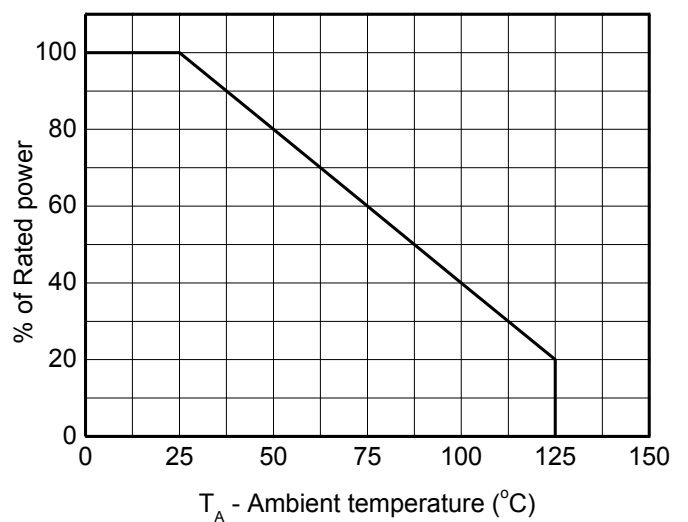
- 1) TLP parameter:  $Z_0 = 50\ \Omega$ ,  $t_p = 100\text{ns}$ ,  $t_r = 2\text{ns}$ , averaging window from 60ns to 80ns.  $R_{DYN}$  is calculated from 4A to 16A.
- 2) Contact discharge mode, according to IEC61000-4-2
- 3) Non-repetitive current pulse, according to IEC61000-4-5.

**Typical characteristics ( $T_A = 25^\circ\text{C}$ , unless otherwise noted)**

**8/20 $\mu\text{s}$  waveform per IEC61000-4-5**

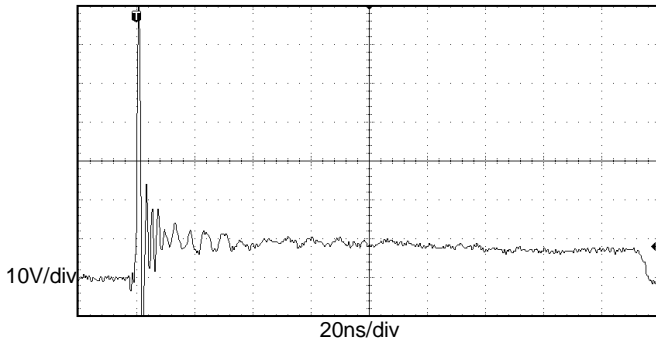
**Contact discharge current waveform per IEC61000-4-2**

**Clamping voltage vs. Peak pulse current**

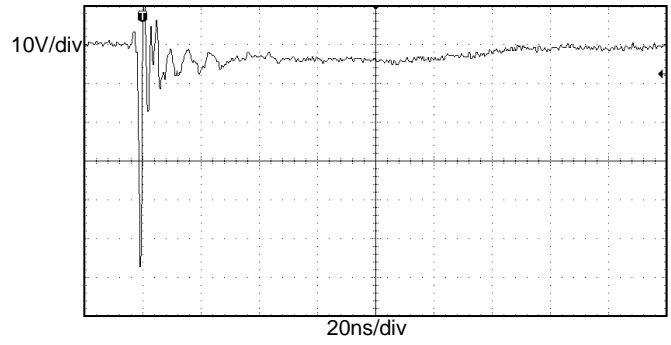
**Capacitance vs. Reverse voltage**

**Non-repetitive peak pulse power vs. Pulse time**

**Power derating vs. Ambient temperature**

Typical characteristics ( $T_A = 25^\circ\text{C}$ , unless otherwise noted)



**ESD clamping**  
 (+8kV contact discharge per IEC61000-4-2)



**ESD clamping**  
 (-8kV contact discharge per IEC61000-4-2)

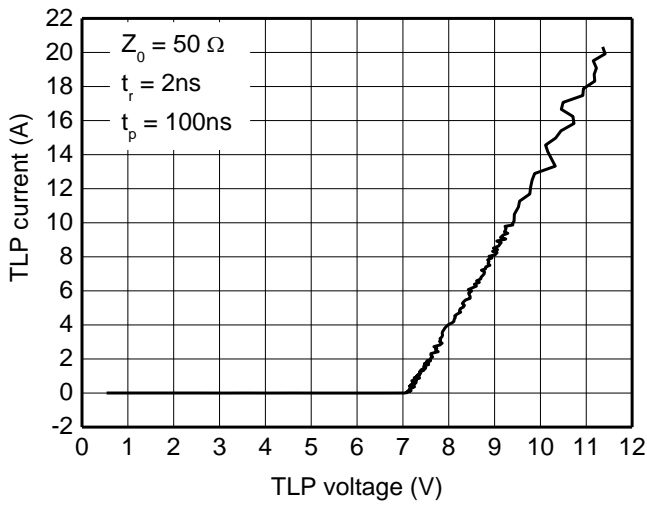

**TLP Measurement**

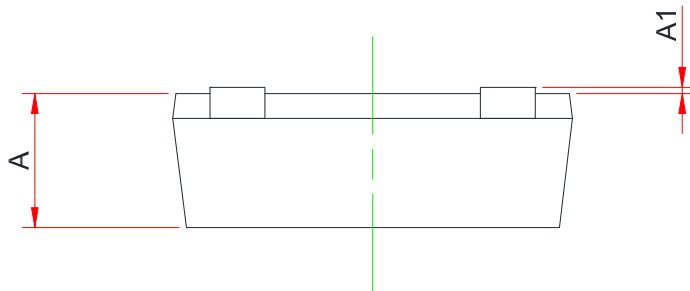
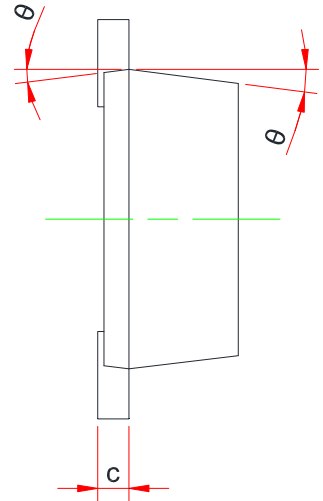
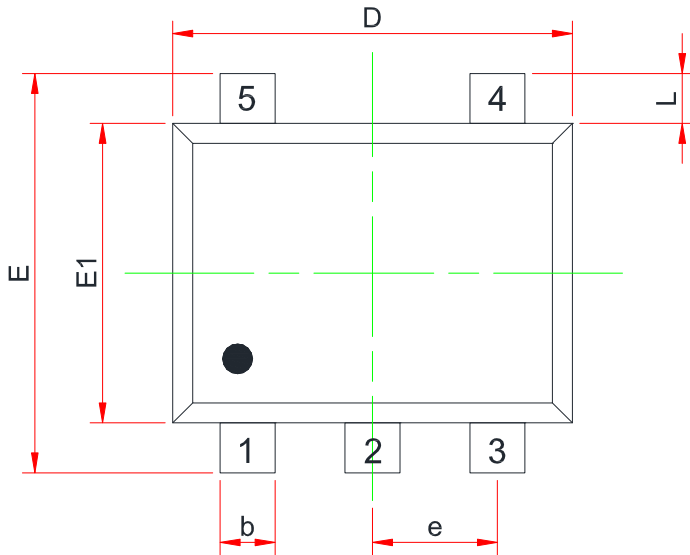
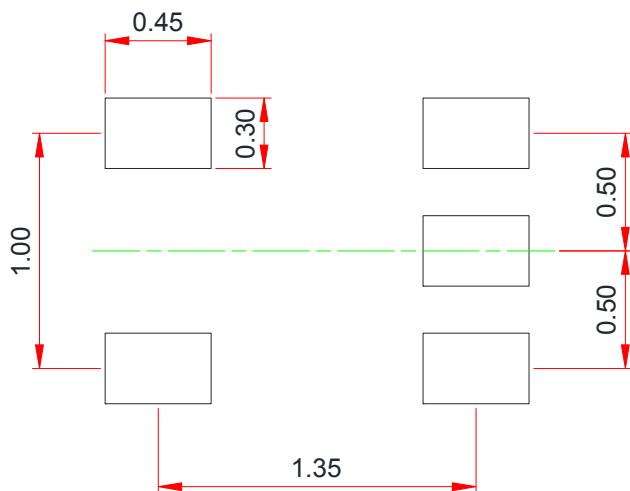
**Package outline dimensions**
**SOT-553**

**Recommend land pattern (Unit: mm)**

Symbol	Dimensions in Millimeters		
	Min.	Typ.	Max.
A	0.525	-	0.600
A1	0.000	-	0.050
D	1.500	-	1.700
E	1.500	-	1.700
E1	1.100	-	1.300
b	0.170	-	0.270
c	0.090	-	0.160
e	0.450	-	0.550
L	0.100	-	0.300
$\theta$	7° REF.		

**Notes:**

This recommended land pattern is for reference purposes only. Please consult your manufacturing group to ensure your PCB design guidelines are met.