

REVISION RECORD			
REV	ECN	DESCRIPTION	DRFT DATE

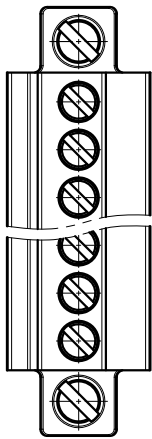

DRILL HOLE(2X)  
 Ø0.80 MAX  
 DEPTH 1.20MM

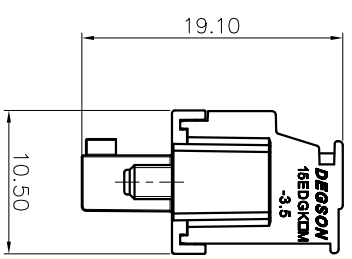
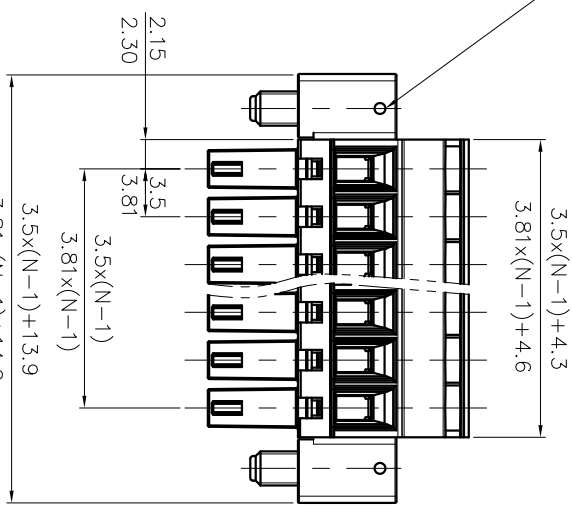
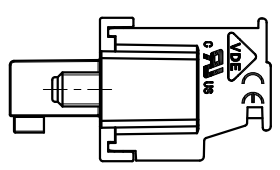

- NOTES1:  
 UL Standard  
 1. Rated voltage/current : 300V / 8A  
 2. Withstanding voltage : AC1600V/1Min.  
 3. Torque value : M2 , 1.77Lb.in  
 4. Wire range : 28~16AWG
- IEC Standard  
 1. Pollution degree 2  
 Overvoltage category II  
 Rate impulse voltage(kV) 2.5kV  
 Rate voltage(V) 250V  
 Rate current(A) 7A
2. Torque value : M2 , 0.2N·m  
 3. Wire range : 0.5~1.5mm<sup>2</sup>

NOTES2:

1. Dimension shall be interpreted per ASME Y14.5-2009  
 2. Pitch : 3.5/3.81mm, Poles : N=02~24P  
 3. Stripping length : 6~7mm  
 4. Operating temperature : -40°C~+105°C  
 5. Undimensioned tolerances:

Pitch	range		In	Nominal dimension		range	Tolerance		
	mm	Over		In	mm			Over	
6	TO	10	TO	30	60	100	0.1/10		
10	TO	24	TO	60	100	150	≤		
15	±0.15	±0.20	±0.30	±0.30	±0.50	±0.70	±1.00	±1.30	±2

6. RoHS Compliance

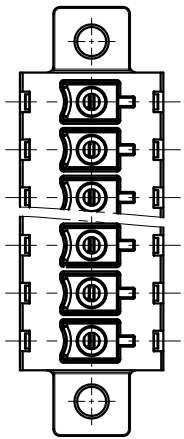
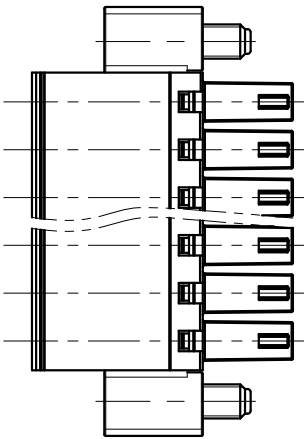
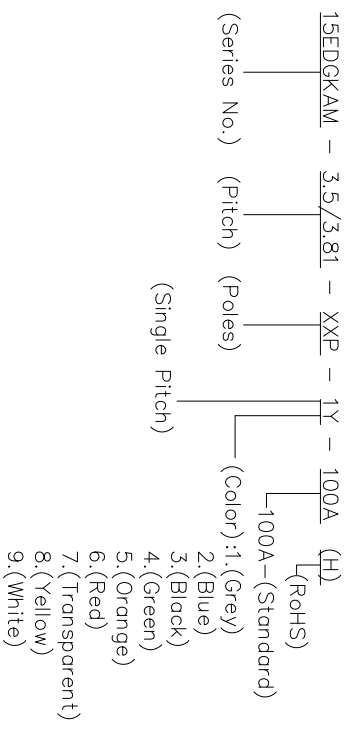

DETACHED LISTS			
PART NO.:	/	NAME:	DEGSON® NINGBO DEGSON ELECTRICAL CO., LTD 宁波高松电子有限公司
APPD:	/	TITLE:	CUSTOMER DRAWING
CHKD:	/	DRAWING NO.:	/
DRFT:	/	DO NOT SCALE DRAWING	SCALE
THIRD ANGLE PROJECTION	3	1:1	1:1