

Description

The MOSFET provide the best combination of fast switching, low on-resistance and cost-effectiveness.

MOSFET Product Summary		
$V_{DS}(V)$	$R_{DS(on)}(\Omega)$	$I_D(A)$
20	0.2 @ $V_{GS}=4.5V$	±1
	0.25 @ $V_{GS}=2.5V$	
	0.31 @ $V_{GS}=1.8V$	

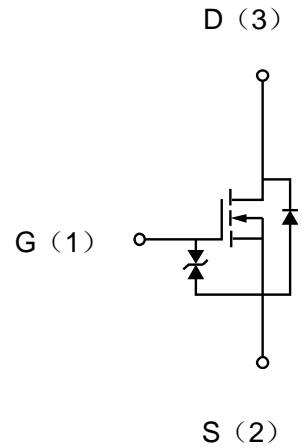

Absolute maximum rating@25°C

Parameter	Symbol	Value	Units
Drain-Source Voltage	V_{DS}	20	V
Gate-Source Voltage	V_{GS}	±8	V
Continuous Drain Current ($T_J=150^\circ C$)	Continuous	±1	A
	Pulsed	±4	
Total power dissipation	P_D	140	mW
Channel temperature	T_{CH}	150	°C
Range of storage temperature	T_{STG}	-55 to +150	°C

Thermal resistance

Parameter	Symbol	Limits	Units
Channel to ambient	$R_{th(ch-a)}$	800	°C/W

Electrical characteristics per line@25°C(unless otherwise specified)

Parameter	Symbol	Conditions	Min.	Typ.	Max.	Units
Drain-Source Breakdown Voltage	BV_{DSS}	$I_D=1mA, V_{GS}=0V$	20		-	V
Zero Gate Voltage Drain Current	I_{DSS}	$V_{DS}=20V, V_{GS}=0V$	-	-	1	μA
Gate-Body Leakage Current	I_{GSS}	$V_{DS}=0V, V_{GS}=\pm 8V$	-	-	± 10	μA
Gate Threshold Voltage	$V_{GS(th)}$	$V_{DS}=10V, I_D=1mA$	0.5	-	1.1	V
Static Drain-Source On-Resistance	$R_{DS(on)}$	$V_{GS}=4.5V, I_D=650mA$	-	0.2	0.25	Ω
		$V_{GS}=2.5V, I_D=450mA$	-	0.25	0.3	Ω
		$V_{GS}=1.8V, I_D=250mA$		0.31	0.45	Ω
Forward transfer admittance	$ Y_{fs} $	$V_{DS}=10V, I_D=300mA$	395			ms
Input Capacitance	C_{ISS}	$V_{GS}=0V, V_{DS}=10V,$ $f=1MHz$	-	30		pF
Output Capacitance	C_{OSS}		-	13		pF
Reverse Transfer Capacitance	C_{RSS}		-	13		pF
Turn-On Delay Time	$t_{d(on)}$	$V_{DD}=10V, V_{GS}=4.0V,$ $R_G=10\Omega, R_L=67\Omega$ $I_D=150mA$	-	7		ns
Turn-Off Delay Time	$t_{d(off)}$		-	23		ns
Turn-On Rise Time	t_r		-	15		ns
Turn-On Fall Time	t_f		-	15		ns
Drain-Source Diode Forward Voltage	V_{SD}	$V_{GS}=0V, I_S=100mA$		-	1.2	V

Typical Characteristics

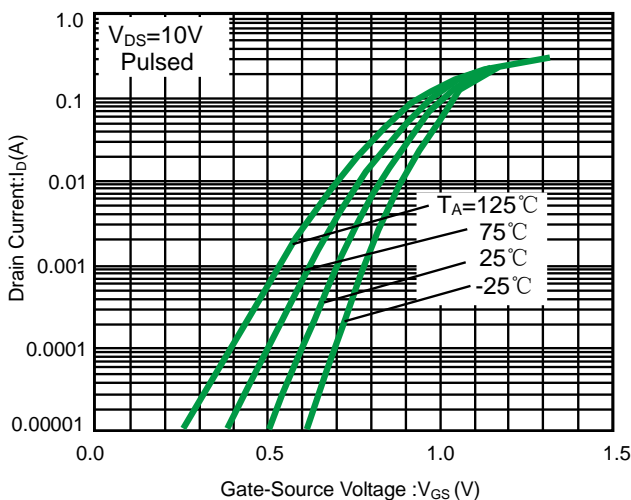

Fig 1. Typical transfer Characteristics

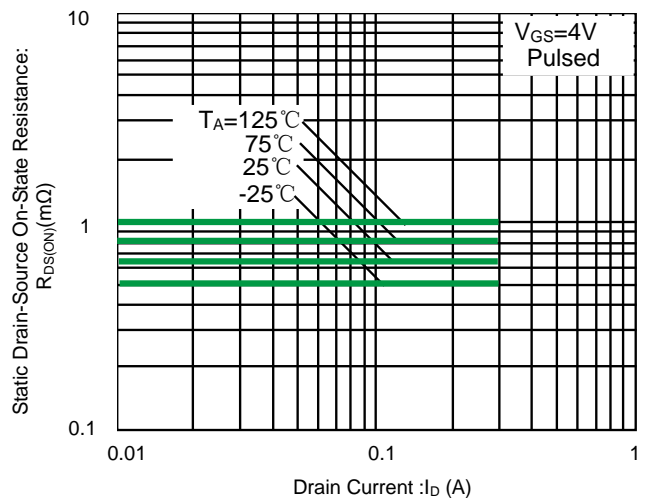

Fig 2. Static drain-source on-state resistance vs. drain current(I)

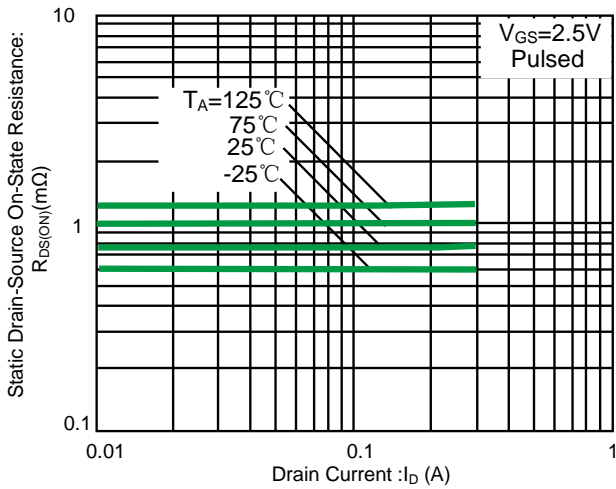

Fig 3. Static drain-source on-state resistance vs. drain current (II)

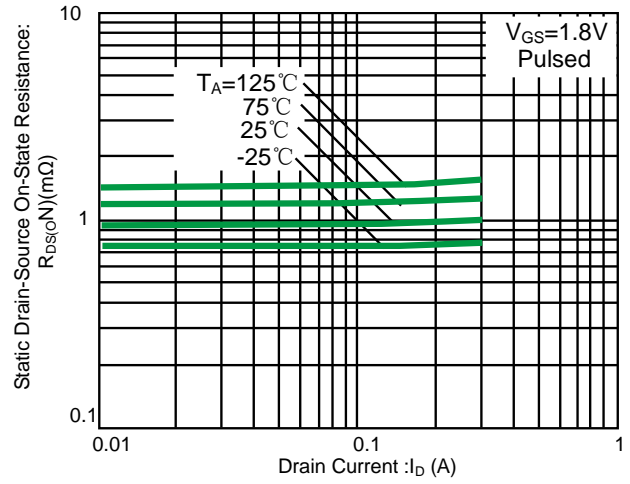

Fig 4. Static drain-source on-state resistance vs. drain current (III)

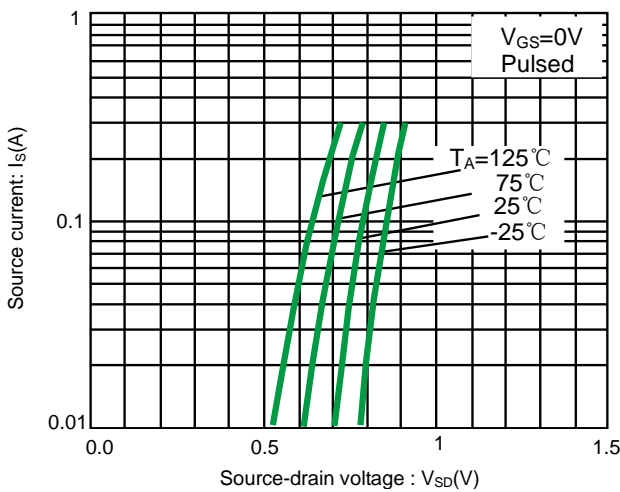

Fig 5. Source current vs. source-drain voltage

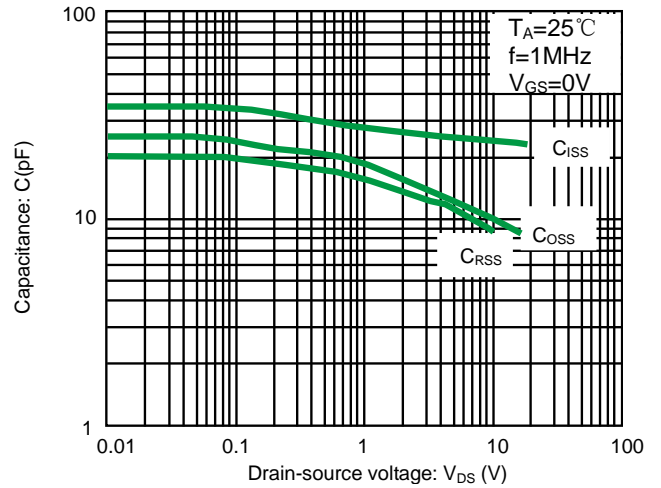

Fig 6. Typical capacitance vs. drain-source voltage

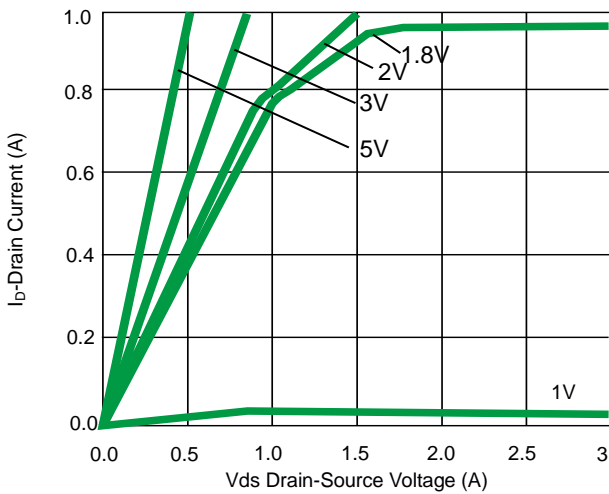

Fig 7. Output Characteristics

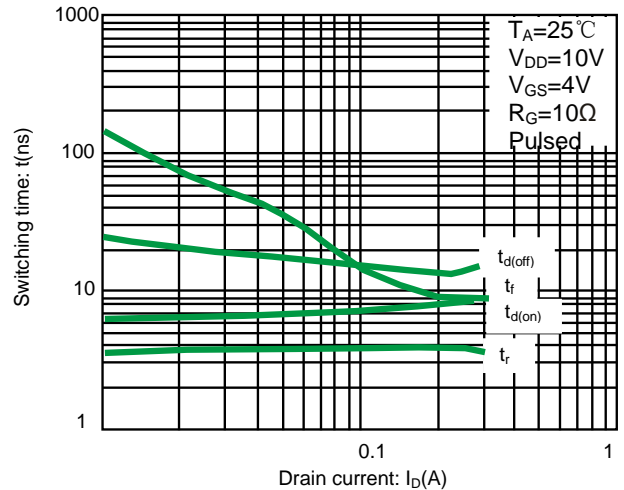

Fig 8. Switching characteristics

Switching characteristics measurement circuit

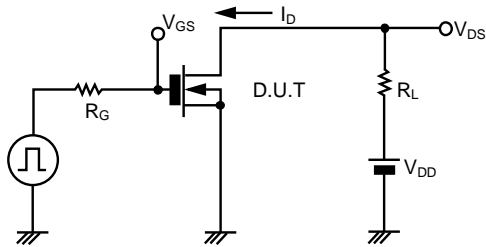

Fig.8 Switching time measurement circuit

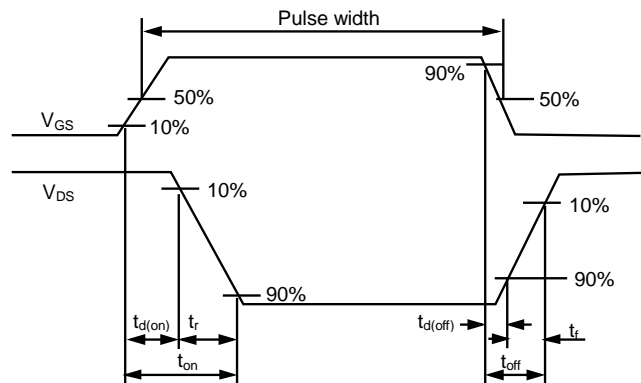
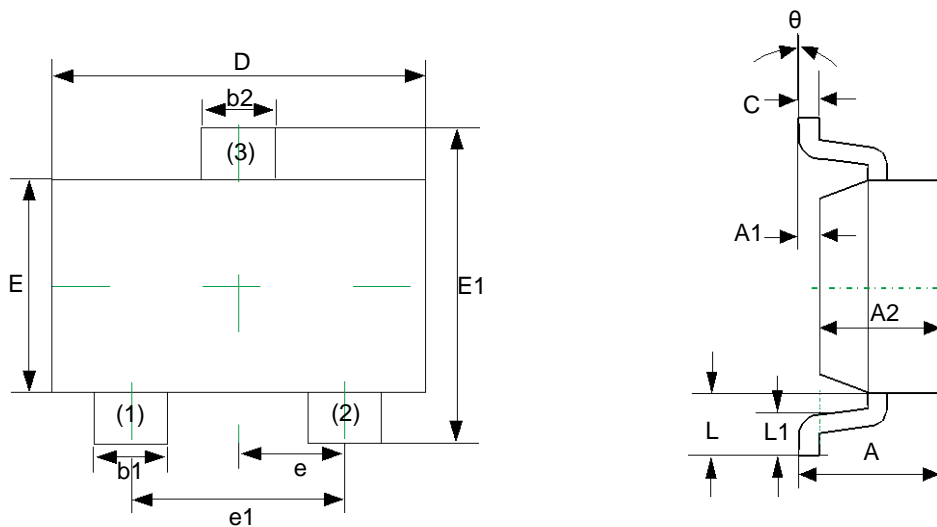
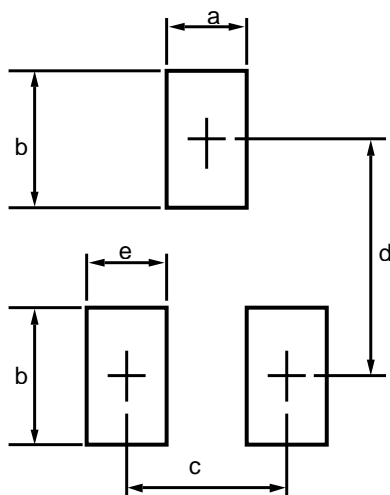

Fig.9 Switching time waveforms

Product dimension (SOT-523)



Dim	Millimeters		Inches	
	MIN	MAX	MIN	MAX
A	0.700	0.900	0.028	0.035
A1	0.000	0.100	0.000	0.004
A2	0.700	0.800	0.028	0.031
b1	0.150	0.250	0.006	0.010
b2	0.250	0.350	0.010	0.014
c	0.100	0.200	0.004	0.008
D	1.500	1.700	0.059	0.067
E	0.700	0.900	0.028	0.035
E1	1.450	1.750	0.057	0.069
e	0.500TYP		0.020TYP	
e1	0.900	1.100	0.035	0.043
L	0.400REF		0.016REF	
L1	0.260	0.460	0.010	0.018
θ	0°	8°	0°	8°



Dim	Millimeters	
	MIN	MAX
a	--	0.5
b	--	0.6
c	--	1.0
d	--	1.24
e	--	0.4

Ordering information

Device	Package	Shipping
PNM523T201E0	SOT-523 (Pb-Free)	3000 / Tape & Reel

IMPORTANT NOTICE

 and **Prisemi**[®] are registered trademarks of **Prisemi Electronics Co., Ltd (Prisemi)** ,Prisemi reserves the right to make changes without further notice to any products herein. Prisemi makes no warranty, representation or guarantee regarding the suitability of its products for any particular purpose, nor does Prisemi assume any liability arising out of the application or use of any product or circuit, and specifically disclaims any and all liability, including without limitation special, consequential or incidental damages. “Typical” parameters which may be provided in Prisemi data sheets and/or specifications can and do vary in different applications and actual performance may vary over time. All operating parameters, including “Typicals” must be validated for each customer application by customer’s technical experts. Prisemi does not convey any license under its patent rights nor the rights of others. The products listed in this document are designed to be used with ordinary electronic equipment or devices, Should you intend to use these products with equipment or devices which require an extremely high level of reliability and the malfunction of with would directly endanger human life (such as medical instruments, aerospace machinery, nuclear-reactor controllers, fuel controllers and other safety devices), please be sure to consult with our sales representative in advance.

Website: <http://www.prisemi.com>

For additional information, please contact your local Sales Representative.

©Copyright 2009, Prisemi Electronics

 **Prisemi**[®] is a registered trademark of Prisemi Electronics.

All rights are reserved.