

LTVS16H5.0ET5G

LTVS16H5.0ET5G

Features

- 5V uni-directional ESD diode
- Low clamping voltage
- Complies with IEC 61000-4-2 standards:
 - Air discharge: $\pm 30\text{kV}$
 - Contact discharge: $\pm 30\text{kV}$
- RoHS Compliant



**MARKING
DIAGRAM**

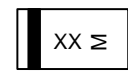

cathode

XX = Specific Device Code
M = Month Code

Ordering information

Device	Marking	Shipping
LTVS16H5.0ET5G	B1	8000/Tape&Reel

Absolute Maximum Ratings ($T_A=25^\circ\text{C}$ unless otherwise specified)

Parameter	Symbol	Value	Unit
Peak Pulse Power (8/20 μs)	Ppk	1800	W
Peak Pulse Current (8/20 μs)	I _{PP}	150	A
Operating Temperature Range	T _J	-55 to +125	$^\circ\text{C}$
Storage Temperature Range	T _{stg}	-55 to +150	$^\circ\text{C}$

Electrical Characteristics ($T_A=25^\circ\text{C}$ unless otherwise specified)

Parameter	Symbol	Min	Typ	Max	Unit	Test Condition
Reverse Working Voltage	V _{RWM}			5	V	
Breakdown Voltage	V _{BR}	6		7.1	V	I _T = 1mA
Reverse Leakage Current	I _R			0.6	μA	V _R = 5V
Clamping Voltage	V _C			10.8	V	I _{PP} = 80A (8 x 20 μs pulse)
Junction Capacitance	C _J		800		pF	V _R = 0V, f = 1MHz

Note: Electrical parameters are only for die, performance may alter after assembly.

LTVS16H5.0ET5G

Typical Performance Characteristics (T_A=25°C unless otherwise Specified)

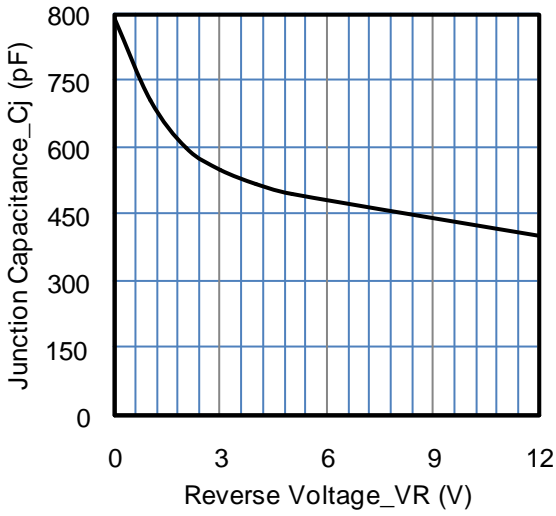

Fig1. Junction Capacitance vs. Reverse Voltage

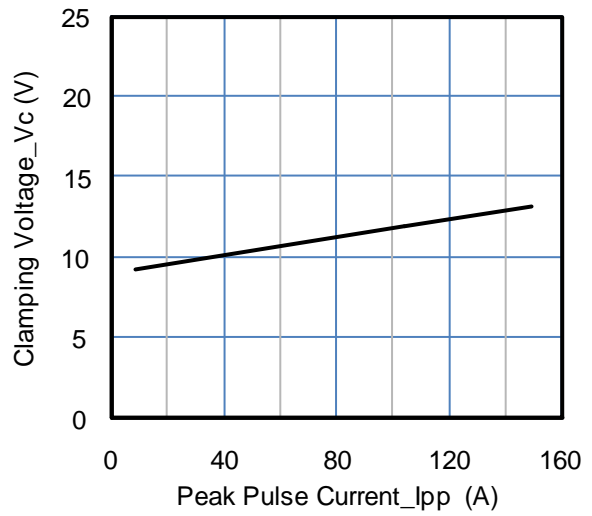

Fig2. Clamping Voltage vs. Peak Pulse Current

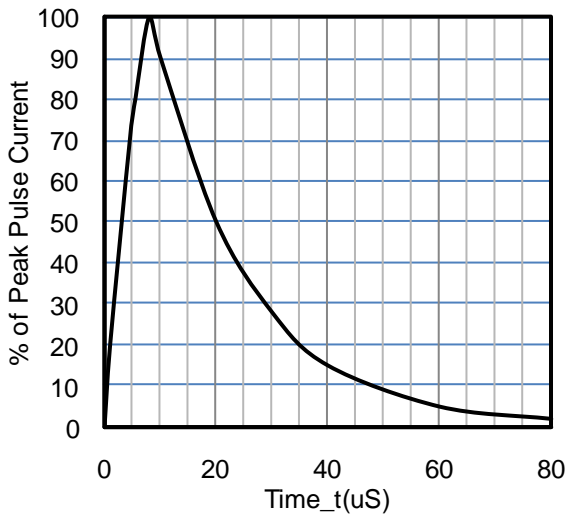

Fig3. 8 X 20uS Pulse Waveform

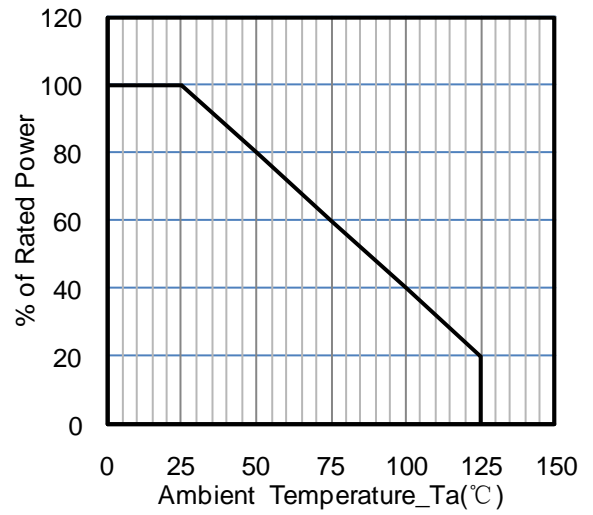

Fig4. Power Derating Curve

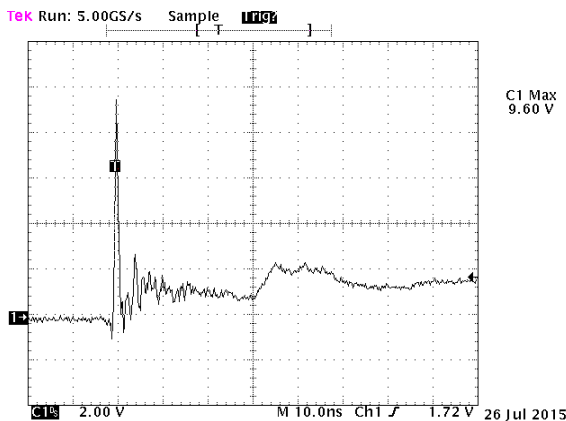

Fig 5. ESD Clamping Voltage
Positive 8 kV Contact per IEC61000-4-2

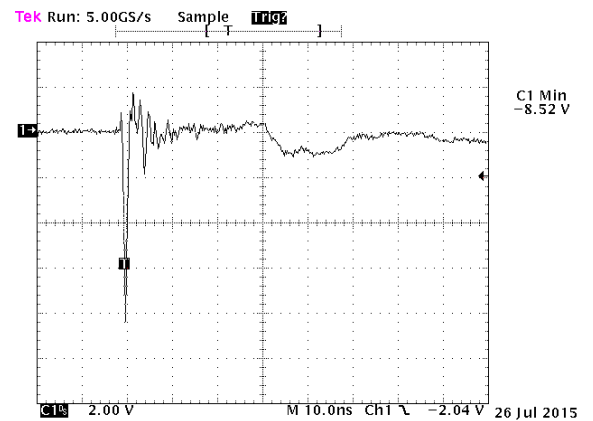
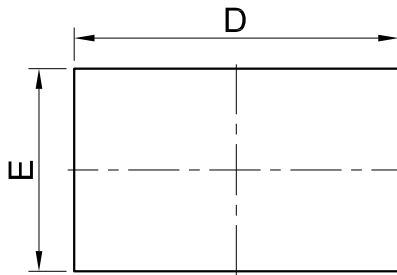

Fig 6. ESD Clamping Voltage
Negative 8 kV Contact per IEC61000-4-2

LTVS16H5.0ET5G

OUTLINE AND DIMENSIONS



TOP VIEW

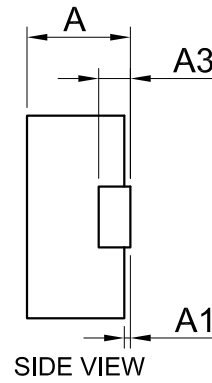

SIDE VIEW

DFN1610			
DIM	MIN	NOR	MAX
A	0.46	0.51	0.56
A1	0.01	0.03	0.05
b	0.75	0.80	0.85
b1	0.25	0.30	0.35
D	1.55	1.60	1.65
E	0.95	1.00	1.05
e	1.10BSC		
L	0.35	0.40	0.45
A3	0.127REF.		
All Dimensions in mm			

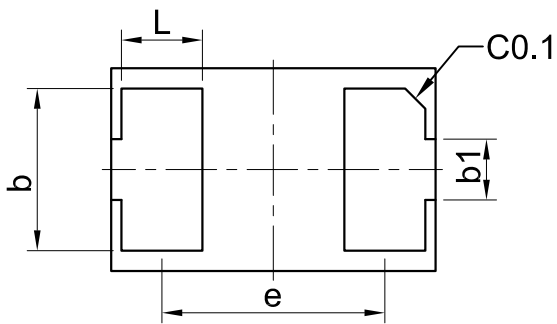

BOTTOM VIEW

SOLDERING FOOTPRINT

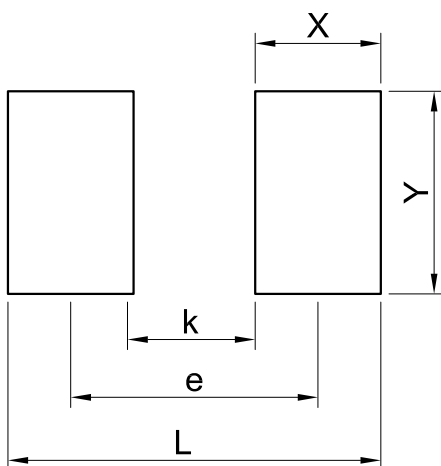

DFN1610	
DIM	(mm)
X	0.62
Y	1.00
L	1.84
e	1.22
K	0.60