

■ Specifications :

- Voltage rating: 250V AC / DC
- Current rating: 10A AC / DC
- Withstanding voltage: 1500V AC/minute
- Temperature range: -25°C~+85°C
- Insulation resistance: $\geq 1000M\Omega$
- Contact resistance: $\leq 10m\Omega$
- After environmental testing: $\leq 20m\Omega$

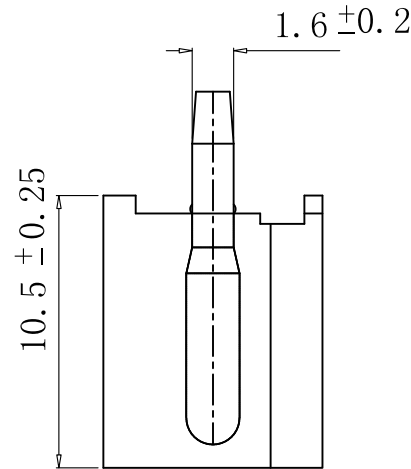
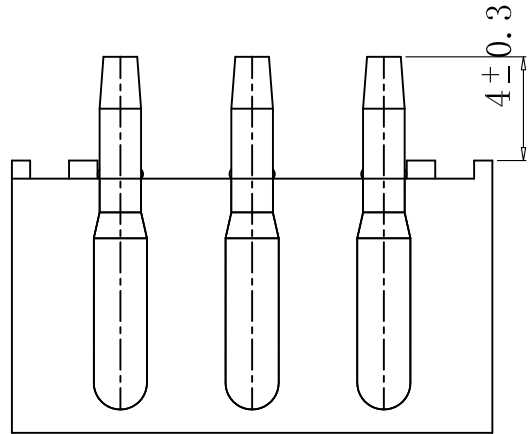

				TOLERANCE UNLESS OTHERWISE		DRAWN	CK tan	XFCN兴飞连接器有限公司 CONNECTORS XFCN CONNECTORS CO., LTD.		SHEET	1/1	
				X.	± 0.30	X°	$\pm 5^\circ$			CHKD	DATE	2010. 4. 12
				.X	± 0.20	.X°	$\pm 2^\circ$	APPD	PRODUCT NAME	5.08mm Crimp Style Connectors	UNITS	mm
				.XX	± 0.08	.XX°	$\pm 1^\circ$	VIEW	PART. NO.	M5082VK-03P	SCALE	1:1
				.XXX	± 0.03	.XXX°	$\pm 0.5^\circ$			DWG. NO.	009	
A0	MODIFICATION		DRAW	DATE								