

**YXJ SERIES**
**105°C Miniaturized, Long Life**

\*Load Life : 105°C 4000~10000 hours.

**◆SPECIFICATIONS**

Items	Characteristics																																				
Category Temperature Range	-40~+105°C																																				
Rated Voltage Range	6.3~100Vdc																																				
Capacitance Tolerance	±20% (20°C, 120Hz)																																				
Leakage Current(MAX)	I=0.01CV or 3µA whichever is greater.(After 2 minutes) I=Leakage Current(µA)      C=Capacitance(µF)      V=Rated Voltage(Vdc)																																				
Dissipation Factor(MAX) (tanδ)	<table border="1"> <thead> <tr> <th>Rated Voltage (Vdc)</th> <th>6.3</th> <th>10</th> <th>16</th> <th>25</th> <th>35</th> <th>50</th> <th>63</th> <th>100</th> </tr> </thead> <tbody> <tr> <td>(20°C, 120Hz)</td> <td>0.22</td> <td>0.19</td> <td>0.16</td> <td>0.14</td> <td>0.12</td> <td>0.10</td> <td>0.09</td> <td>0.08</td> </tr> </tbody> </table> <p>When capacitance is over 1000µF, tanδ shall be added 0.02 to the listed value with increase of every 1000µF.</p>	Rated Voltage (Vdc)	6.3	10	16	25	35	50	63	100	(20°C, 120Hz)	0.22	0.19	0.16	0.14	0.12	0.10	0.09	0.08																		
Rated Voltage (Vdc)	6.3	10	16	25	35	50	63	100																													
(20°C, 120Hz)	0.22	0.19	0.16	0.14	0.12	0.10	0.09	0.08																													
Endurance	<p>After applying rated voltage with rated ripple current for specified time at 105°C, the capacitors shall meet the following requirements.</p> <table border="1"> <thead> <tr> <th rowspan="2">Capacitance Change</th> <th rowspan="2">Within ±25% of the initial value.(6.3V:±30%)</th> <th colspan="2">Life Time(hrs)</th> </tr> <tr> <th>6.3~10Vdc</th> <th>16~100Vdc</th> </tr> </thead> <tbody> <tr> <td>Dissipation Factor</td> <td>Not more than 200% of the specified value.</td> <td>φD=5</td> <td>4000    5000</td> </tr> <tr> <td rowspan="2">Leakage Current</td> <td rowspan="2">Not more than the specified value.</td> <td>φD=6.3,8</td> <td>6000    7000</td> </tr> <tr> <td>φD≥10</td> <td>8000    10000</td> </tr> </tbody> </table>	Capacitance Change	Within ±25% of the initial value.(6.3V:±30%)	Life Time(hrs)		6.3~10Vdc	16~100Vdc	Dissipation Factor	Not more than 200% of the specified value.	φD=5	4000    5000	Leakage Current	Not more than the specified value.	φD=6.3,8	6000    7000	φD≥10	8000    10000																				
Capacitance Change	Within ±25% of the initial value.(6.3V:±30%)			Life Time(hrs)																																	
		6.3~10Vdc	16~100Vdc																																		
Dissipation Factor	Not more than 200% of the specified value.	φD=5	4000    5000																																		
Leakage Current	Not more than the specified value.	φD=6.3,8	6000    7000																																		
		φD≥10	8000    10000																																		
Low Temperature Stability Impedance Ratio(MAX)	<table border="1"> <thead> <tr> <th>Rated Voltage (Vdc)</th> <th>6.3</th> <th>10</th> <th>16</th> <th>25</th> <th>35</th> <th>50</th> <th>63</th> <th>100</th> </tr> </thead> <tbody> <tr> <td>(120Hz)</td> <td colspan="8"></td> </tr> <tr> <td>Z(-25°C)/Z(20°C)</td> <td>4</td> <td>3</td> <td>2</td> <td>2</td> <td>2</td> <td>2</td> <td>2</td> <td>2</td> </tr> <tr> <td>Z(-40°C)/Z(20°C)</td> <td>8</td> <td>6</td> <td>4</td> <td>3</td> <td>3</td> <td>3</td> <td>3</td> <td>3</td> </tr> </tbody> </table>	Rated Voltage (Vdc)	6.3	10	16	25	35	50	63	100	(120Hz)									Z(-25°C)/Z(20°C)	4	3	2	2	2	2	2	2	Z(-40°C)/Z(20°C)	8	6	4	3	3	3	3	3
Rated Voltage (Vdc)	6.3	10	16	25	35	50	63	100																													
(120Hz)																																					
Z(-25°C)/Z(20°C)	4	3	2	2	2	2	2	2																													
Z(-40°C)/Z(20°C)	8	6	4	3	3	3	3	3																													

**◆MULTIPLIER FOR RIPPLE CURRENT**

(6.3Vdc~50Vdc)

Frequency (Hz)		120	1k	10k	100k≤
Coefficient	1µF	0.35	0.60	0.80	1.00
	2.2~10µF	0.42	0.60	0.80	1.00
	22~47µF	0.55	0.75	0.90	1.00
	100~330µF	0.70	0.85	0.95	1.00
	470~1000µF	0.75	0.90	0.98	1.00
	2200~15000µF	0.80	0.95	1.00	1.00

(63Vdc~100Vdc)

Frequency (Hz)	120	1k	10k	100k≤
Coefficient	0.42	0.60	0.80	1.00

**◆DIMENSIONS**

(mm)

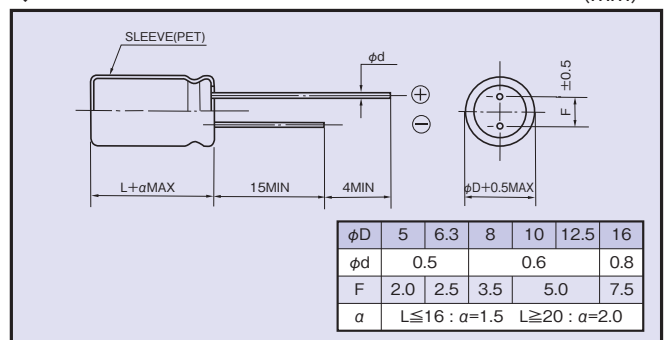
**◆OPTION**

	Code
PET Sleeve	Blank

**◆PART NUMBER**

□□□	YXJ	□□□□□	M	□□□	□□	D×L
Rated Voltage	Series	Capacitance	Capacitance Tolerance	Option	Lead Forming	Case Size

**◆STANDARD SIZE**

Rated Voltage (Vdc)	Capacitance (μF)	Size φD×L(mm)	Rated ripple current (mA r.m.s./105°C, 100kHz)	Impedance (Ω MAX)	
				20°C, 100kHz	-10°C, 100kHz
6.3	100	5×11	150	0.90	3.6
	220	5×11	250	0.40	1.2
	330	6.3×11	340	0.22	0.87
	470	6.3×11	400	0.22	0.87
	1000	8×11.5	640	0.13	0.52
	2200	10×16	1300	0.062	0.25
	3300	10×20	1400	0.046	0.18
	4700	12.5×25	2230	0.032	0.11
	6800	12.5×25	2230	0.032	0.11
	10000	16×25	2930	0.021	0.060
15000	16×35.5	3610	0.015	0.044	
10	100	5×11	150	0.90	3.6
	220	5×11	250	0.40	1.2
	330	6.3×11	400	0.22	0.87
	470	6.3×11	400	0.22	0.87
	1000	10×12.5	865	0.080	0.32
	2200	10×20	1400	0.046	0.18
	3300	12.5×20	1900	0.041	0.14
	4700	12.5×25	2230	0.032	0.11
	6800	16×25	2930	0.021	0.060
10000	16×31.5	3450	0.019	0.056	
16	47	5×11	250	0.40	1.2
	100	5×11	250	0.40	1.2
	220	6.3×11	400	0.22	0.87
	330	6.3×11	400	0.22	0.87
	470	8×11.5	640	0.13	0.52
	1000	10×16	1210	0.062	0.25
	2200	12.5×20	1900	0.041	0.14
	3300	12.5×25	2230	0.032	0.11
	4700	16×25	2930	0.021	0.060
6800	16×31.5	3450	0.019	0.056	
25	33	5×11	250	0.40	1.2
	47	5×11	250	0.40	1.2
	100	5×11	250	0.40	1.2
	220	6.3×11	400	0.22	0.87
	330	8×11.5	640	0.13	0.52
	470	10×12.5	865	0.080	0.32
	1000	10×20	1400	0.046	0.18
	2200	12.5×25	2230	0.032	0.11
	3300	16×25	2930	0.021	0.060
4700	16×31.5	3450	0.019	0.056	
35	33	5×11	250	0.40	1.2
	47	5×11	250	0.40	1.2
	100	6.3×11	400	0.22	0.87
	220	8×11.5	640	0.13	0.52
	330	10×12.5	865	0.080	0.32
	470	10×16	1210	0.062	0.25
	1000	12.5×20	1900	0.041	0.14
	2200	16×25	2930	0.021	0.060
3300	16×31.5	3450	0.019	0.056	

Rated Voltage (Vdc)	Capacitance (μF)	Size φD×L(mm)	Rated ripple current (mA r.m.s./105°C, 100kHz)	Impedance (Ω MAX)	
				20°C, 100kHz	-10°C, 100kHz
50	1	5×11	30	4.0	8.0
	2.2	5×11	43	2.5	6.0
	3.3	5×11	53	2.2	5.6
	4.7	5×11	88	1.9	5.0
	10	5×11	100	1.5	4.0
	22	5×11	180	0.70	2.8
	33	5×11	250	0.70	2.8
	47	6.3×11	295	0.30	1.2
	100	8×11.5	555	0.17	0.68
	220	10×16	1050	0.084	0.34
	330	10×20	1220	0.060	0.24
	470	12.5×20	1660	0.045	0.15
	1000	16×25	2730	0.032	0.096
	2200	16×35.5	3150	0.019	0.057
63	10	5×11	173	0.88	3.5
	22	5×11	173	0.88	3.5
	33	6.3×11	278	0.35	1.4
	47	6.3×11	278	0.35	1.4
	100	10×12.5	725	0.15	0.60
	220	10×20	1200	0.078	0.31
	330	12.5×20	1570	0.060	0.19
	470	12.5×25	1990	0.043	0.14
	1000	16×25	2730	0.032	0.096
100	1	5×11	20	4.5	15.0
	2.2	5×11	30	3.0	13.0
	3.3	5×11	40	2.7	11.0
	4.7	5×11	65	2.5	10.0
	10	6.3×11	267	0.57	2.3
	22	6.3×11	267	0.57	2.3
	33	8×11.5	462	0.36	1.4
	47	8×16	585	0.25	1.0
	100	10×20	1040	0.12	0.52
	220	12.5×25	1620	0.060	0.23
	330	16×25	2210	0.044	0.16