



BYD Microelectronics Co., Ltd.

# BG150B12UY3-I

## IGBT Power Module

$V_{CE}=1200V$   $I_C=150A$

### General Description

BYD IGBT Power Module BG150B12UY3-I provides fast switching characteristic as well as high short circuit capability, which introduce the advanced IGBT chip/FWD and improved connection.

### Features

- High speed IGBT in trench/field stop technology
- Including ultra fast & soft recovery anti-parallel FWD
- Low inductance
- Standard package
- High short circuit capability
- Fast switching and short tail current

### Applications

- High frequency drivers
- AC motor control
- Inverters
- Servo
- UPS (Uninterruptible Power Supplies)
- Electric welding



### Characteristic values

Parameter	Symbol	Conditions	Temperature	Value	Unit
<b>Absolute Maximum Ratings</b>					
Collector-emitter voltage	$V_{CES}$	$I_C=6mA, V_{GE}=0V$	$T_{vj}=25^{\circ}C$	1200	V
Continuous collector current	$I_C$	—	$T_c=80^{\circ}C$	150	A
Peak collector current	$I_{CRM}$	$I_{CRM}=2I_C$	—	300	A
Gate-emitter voltage	$V_{GES}$	—	—	+/-20	V
Total power dissipation	$P_{tot}$	per switch (IGBT)	$T_c = 25^{\circ}C$	tbd	W
IGBT short circuit SOA	$t_{psc}$	$V_{CC}=600V, V_{GE}\leq 15V$ $V_{CEM}\leq 1200V$	$T_{vj}\leq 125^{\circ}C$	10	us
Max. junction temperature	$T_{vj\ max}$	—	—	150	$^{\circ}C$
Operation junction temperature	$T_{vj\ op}$	—	—	-40~150	$^{\circ}C$
Storage temperature range	$T_{stg}$	—	—	-40~125	$^{\circ}C$
Diode DC forward current	$I_F$	—	$T_c=80^{\circ}C$	150	A
Peak forward current	$I_{FRM}$	$I_{FRM}=2I_F$	—	300	A
$I^2t$ -value, Diode	$I^2t$	$V_R=0V, t=10ms$	$T_j=125^{\circ}C$	—	$A^2s$
Isolation voltage	$V_{isol}$	$t=1min, f=50Hz$	—	2500	V



Parameter	Symbol	Conditions	Temperature	Value			Unit
<b>Characteristics</b>							
<b>IGBT</b>				<b>min.</b>	<b>typ.</b>	<b>max.</b>	
Gate-emitter threshold voltage	$V_{GE(th)}$	$I_c=6mA, V_{GE}=V_{CE}$	$T_{vj}=25^{\circ}C$	5.0	5.5	6.5	V
Collector-emitter cut-off current	$I_{CES}$	$V_{CE}=1200V, V_{GE}=0V$	$T_{vj}=25^{\circ}C$	—	—	1.0	mA
			$T_{vj}=125^{\circ}C$	—	—	10	mA
Gate-emitter cut-off current	$I_{GES}$	$V_{CE}=0V, V_{GE}=\pm 20V$	$T_{vj}=25^{\circ}C$	-300	—	300	nA
Collector-emitter saturation voltage	$V_{CE(sat)}$	$I_c=150A, V_{GE}=15V$	$T_{vj}=25^{\circ}C$	—	2.6	—	V
			$T_{vj}=125^{\circ}C$	—	3.4	—	V
Integrated gate resistor	$R_{Gint}$	—	$T_{vj}=25^{\circ}C$	—	—	—	$\Omega$
Total Gate Charge	$Q_g$	$V_{CE}=600V, I_c=150A, V_{GE}=\pm 15V$	—	—	tbd	—	$\mu C$
Gate-Emitter Charge	$Q_{ge}$		—	—	tbd	—	$\mu C$
Gate-Collector Charge	$Q_{gc}$		—	—	tbd	—	$\mu C$
Input capacitance	$C_{ies}$	$V_{CE}=25V, V_{GE}=0V, f=1MHz$	$T_{vj}=25^{\circ}C$	—	tbd	—	nF
Output capacitance	$C_{oes}$			—	tbd	—	nF
Reverse transfer capacitance	$C_{res}$			—	tbd	—	nF
Turn-on delay time	$t_{d(on)}$	$V_{CC}=600V, I_c=150A, R_{Gon}=R_{Goff}=3.3\Omega, V_{GE}=\pm 15V, L_{\sigma}=80nH, \text{Inductive load}$	$T_{vj}=25^{\circ}C$	—	283	—	ns
			$T_{vj}=125^{\circ}C$	—	300	—	ns
Rise time	$t_r$		$T_{vj}=25^{\circ}C$	—	145	—	ns
			$T_{vj}=125^{\circ}C$	—	51	—	ns
Turn-off delay time	$t_{d(off)}$		$T_{vj}=25^{\circ}C$	—	34	—	ns
			$T_{vj}=125^{\circ}C$	—	375	—	ns
Fall time	$t_f$		$T_{vj}=25^{\circ}C$	—	48	—	ns
			$T_{vj}=125^{\circ}C$	—	166	—	ns
Energy dissipation during turn-on time	$E_{on}$		$T_{vj}=25^{\circ}C$	—	7.0	—	mJ
			$T_{vj}=125^{\circ}C$	—	14.4	—	mJ
Energy dissipation during turn-off time	$E_{off}$	$T_{vj}=25^{\circ}C$	—	6.5	—	mJ	
		$T_{vj}=125^{\circ}C$	—	9.0	—	mJ	
<b>Diode</b>				<b>min.</b>	<b>typ.</b>	<b>max.</b>	
Forward voltage	$V_F$	$I_F=150A$	$T_{vj}=25^{\circ}C$	—	1.7	—	V
			$T_{vj}=125^{\circ}C$	—	1.7	—	V
Peak reverse recovery current	$I_{RR}$	$I_F=150A, V_R=600V, di_F/dt=1100A/\mu s$	$T_{vj}=125^{\circ}C$	—	210	—	A
Recovered charge	$Q_{rr}$		$T_{vj}=125^{\circ}C$	—	26.4	—	$\mu C$
Reverse recovery time	$t_{rr}$		$T_{vj}=125^{\circ}C$	—	299	—	ns
Reverse recovery energy	$E_{rec}$		$T_{vj}=125^{\circ}C$	—	14.0	—	mJ



Parameter	Symbol	Conditions	min.	typ.	Max.	Unit	
<b>Thermal-Mechanical Specifications</b>							
IGBT thermal resistance junction to case	$R_{th(j-c)}$	per IGBT	—	tbd	—	K/W	
Diode thermal resistance junction to case	$R_{th(j-c)}$	per diode	—	tbd	—	K/W	
Thermal resistance case to heat-sink	$R_{th(c-s)}$	per module	—	0.03	—	K/W	
Dimensions	L x W x H	Typical , see outline drawing	106.4 x 61.4 x 31.5			mm	
Clearance distance in air	da	according to IEC 60664-1 and EN 50124-1	Term. to base:	—	—	28.3	mm
			Term. to term:	6.0	—	—	
Surface creepage distance	ds	according to IEC 60664-1 and EN 50124-1	Term. to base:	—	24	—	mm
			Term. to term:	—	14	—	
Mass	m	—	—	320	—	g	

Thermal and mechanical properties according to IEC 60747 – 15

Specification according to the valid application note.

## Characterization curves

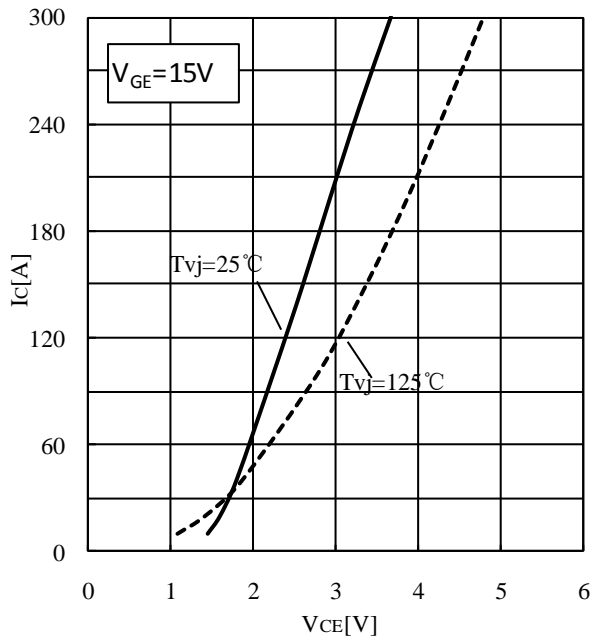

Fig.1 Typ. On-state Characteristics

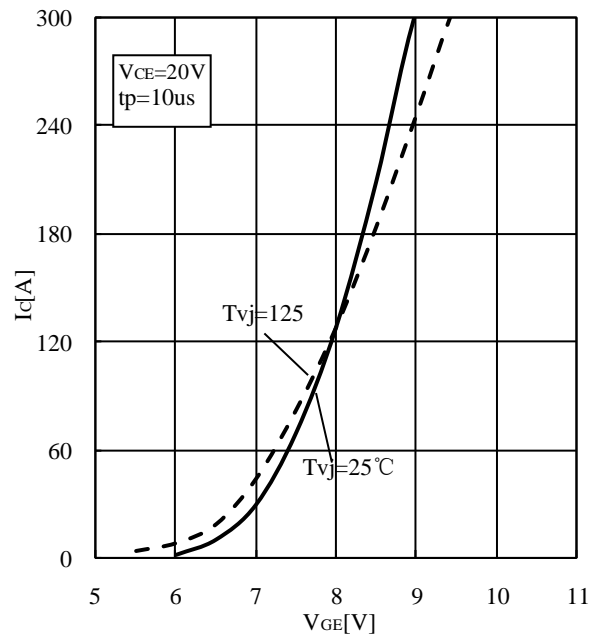

Fig.2 Typ. Transfer Characteristics

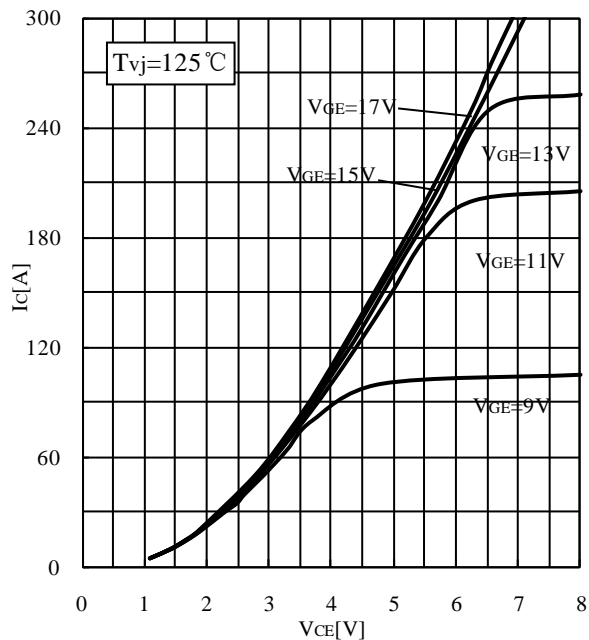

Fig.3 Typ. Output Characteristics

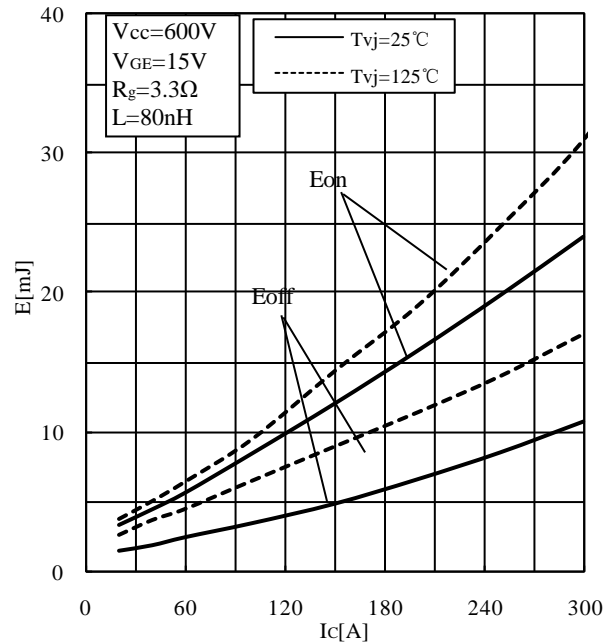

Fig.4 Switching Loss vs. Collector Current

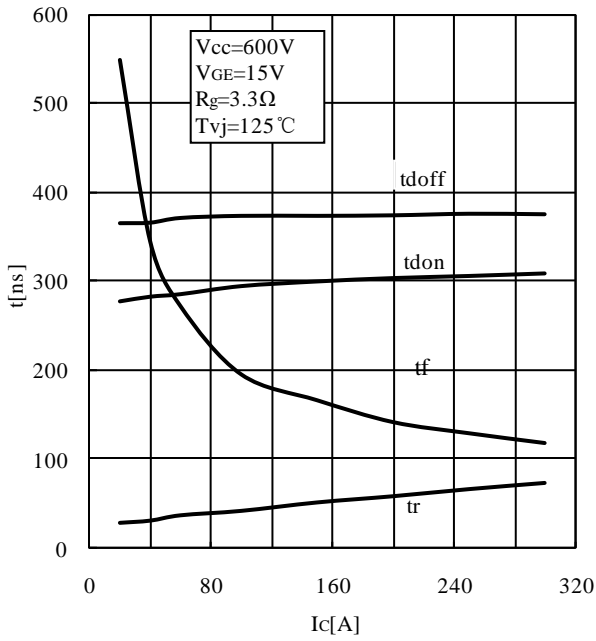

Fig.5 Typ. Switching Times vs. Ic

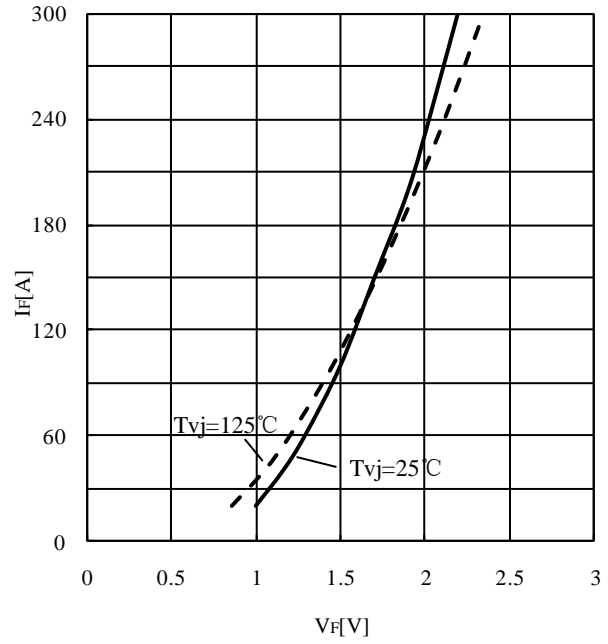

Fig.6 FWD Forward Characteristics

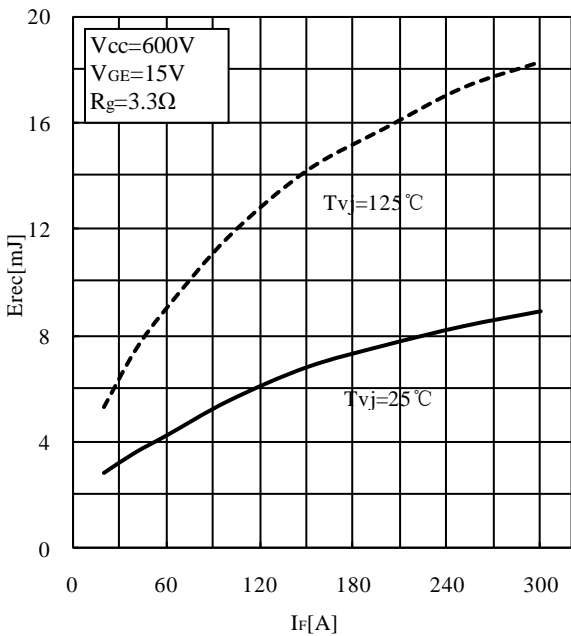

Fig.7 Typ. Switching Losses Diode-inverter

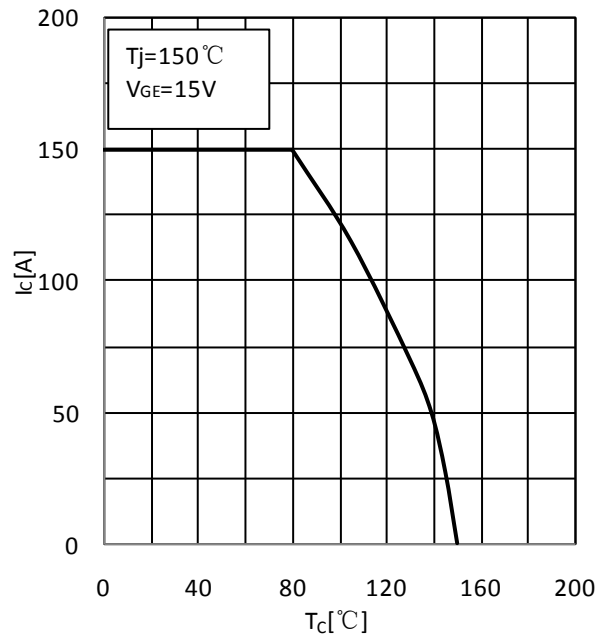

Fig. 8 Rate Current vs. Temperature ( $T_c$ )

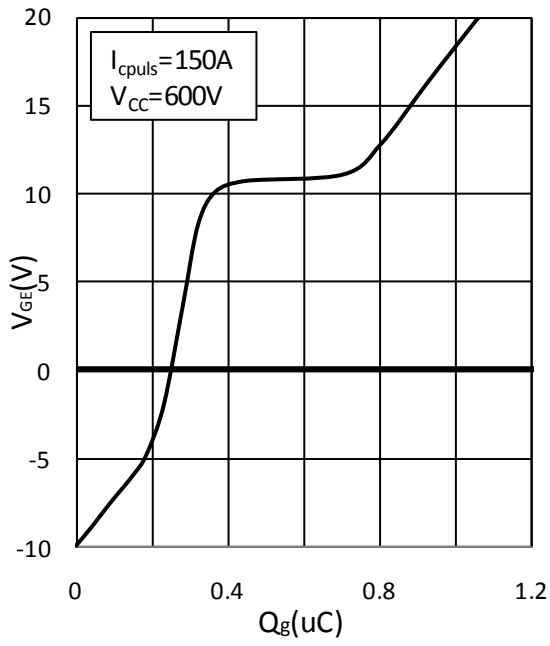

Fig.9 Typ. Gate Charge Characteristics

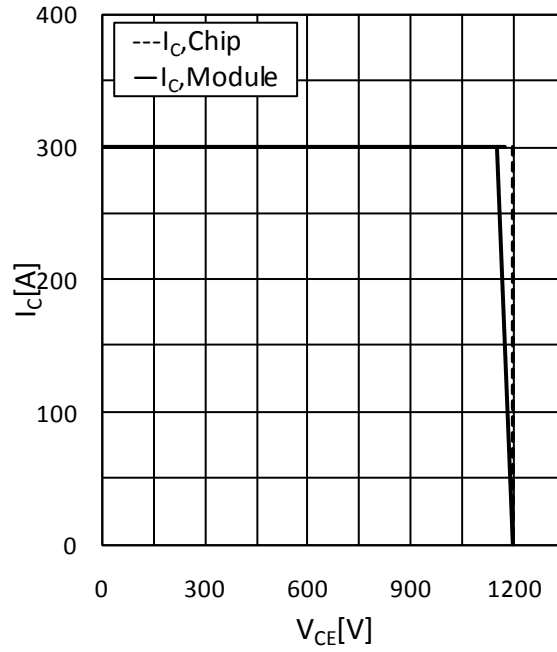
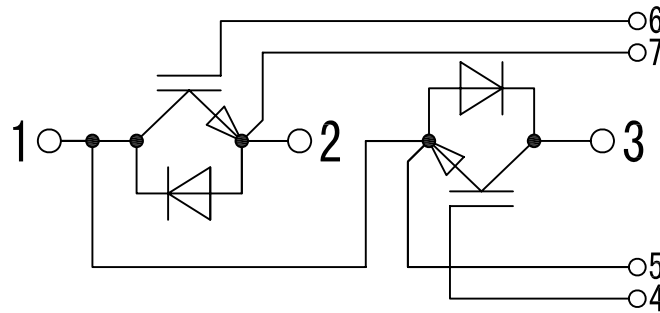

Fig.10 Reverse Bias Safe Operating Area (RBSOA)

## Circuit Diagram



## Package Outlines

### Dimensions in mm

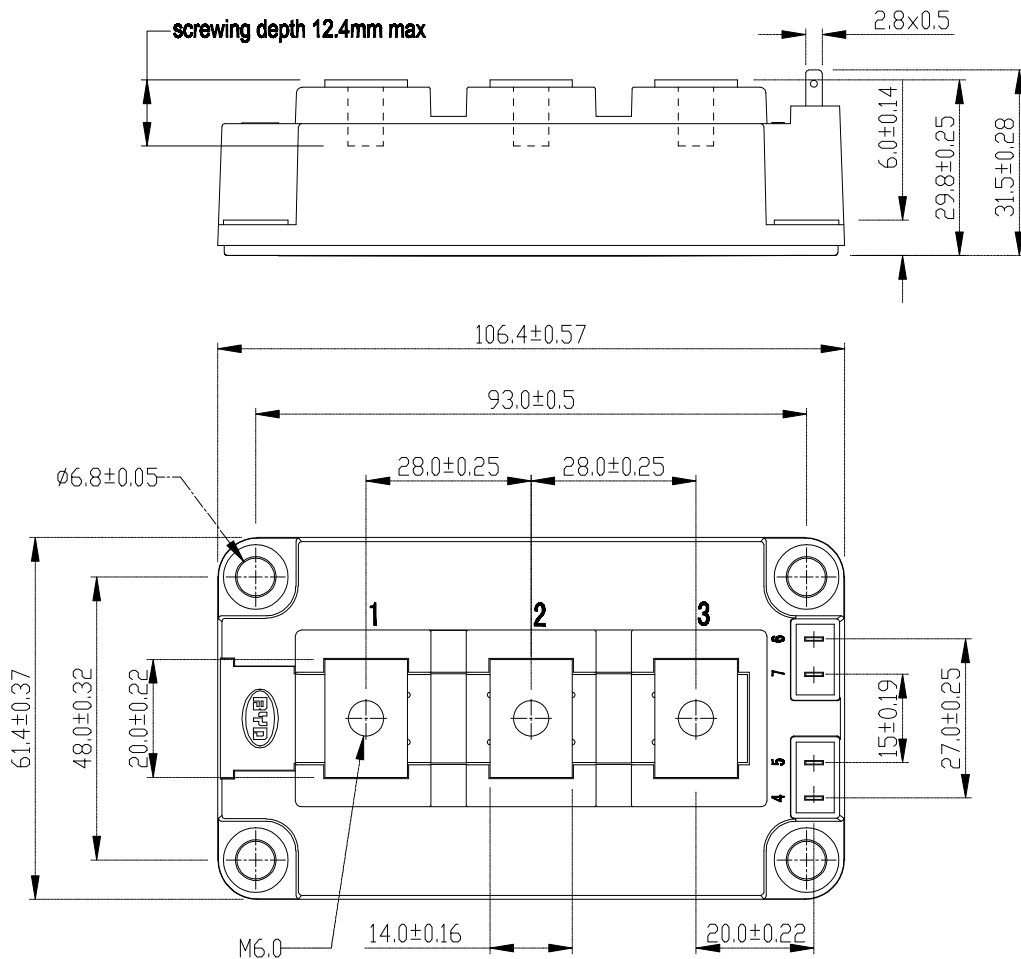

## Attached (recommended torque):

$M_S$  : (to heat sink M6) 3~6 Nm

$M_t$  : (to terminals M6) 2.5~5 Nm



## Attention

1. In order to reduce the contact resistance, we suggest add thermal grease between base and heat-sink, which thickness is about 0.1mm.
2. When installing the module, please wear a electrostatic bracelet to prevent the gate breakdown and the imbalance power may damage the internal chip, even to damage the module.
3. This is an electrostatic sensitive device, please observe the international standard IEC 60747-1, chap. IX.

## RESTRICTIONS ON PRODUCT USE

- The information contained herein is subject to change without notice.
- BYD Microelectronics Co., Ltd. (short for BME) exerts the greatest possible effort to ensure high quality and reliability. Nevertheless, semiconductor devices in general can malfunction or fail due to their inherent electrical sensitivity and vulnerability to physical stress. It is the responsibility of the buyer, when utilizing BME products, to comply with the standards of safety in making a safe design for the entire system, including redundancy, fire-prevention measures, and malfunction prevention, to prevent any accidents, fires, or community damage that may ensue. In developing your designs, please ensure that BME products are used within specified operating ranges as set forth in the most recent BME products specifications.
- The BME products listed in this document are intended for usage in general electronics applications (personal equipment, measuring equipment, industrial robotics, domestic appliances, etc.). These BME products are neither intended nor warranted for usage in equipment that requires extraordinarily high quality and/or reliability or a malfunction or failure of which may cause loss of human life or bodily injury ("Unintended Usage"). Unintended Usage include atomic energy control instruments, airplane or spaceship instruments, transportation instruments, traffic signal instruments, combustion control instruments, medical instruments, all types of safety devices, etc.. Unintended Usage of BME products listed in this document shall be made at the customer's own risk.