

MAXIM

32-Tap FleaPoT™, 2-Wire Digital Potentiometers

MAX5460–MAX5468

General Description

The MAX5460–MAX5468 linear-taper digital potentiometers perform the same function as a mechanical potentiometer or a variable resistor. These devices consist of a fixed resistor and a wiper contact with 32-tap points that are digitally controlled through a 2-wire serial interface.

The MAX5462/MAX5465/MAX5468 are configured as potentiometers. The rest of the devices in this family are configured as variable resistors. See *Pin Configurations* for part functionality.

Three resistance values are available: 10k Ω (MAX5466/MAX5467/MAX5468), 50k Ω (MAX5463/MAX5464/MAX5465), and 100k Ω (MAX5460/MAX5461/MAX5462). The MAX5460–MAX5465 (100k Ω and 50k Ω) are available in space-saving 5-pin and 6-pin SC70 packages. The MAX5466/MAX5467/MAX5468 (10k Ω) are available in 5-pin and 6-pin SOT23 packages.

Applications

LCD Screen Adjustment
Volume Control
Mechanical Potentiometer Replacement
Gain Adjustment
Line Impedance Matching

FleaPoT is a trademark of Maxim Integrated Products Inc.

Functional Diagram appears at end of data sheet.

Features

- ◆ Miniature SC70 and SOT23 Packages
- ◆ 0.3 μ A Ultra-Low Supply Current
- ◆ +2.7V to +5.5V Single-Supply Operation
- ◆ Glitchless Switching Between Resistor Taps
- ◆ Power-On Reset to Midscale
- ◆ 2-Wire Up/Down Serial Interface
- ◆ 10k Ω , 50k Ω , and 100k Ω Resistance Values

Ordering Information

PART	PIN-PACKAGE	TOP MARK	R (k Ω)	PKG CODE
MAX5460EXK	5 SC70	ACA	100	X5-1
MAX5461EXT	6 SC70	AAP	100	X6S-1
MAX5462EXT	6 SC70	AAQ	100	X6S-1
MAX5463EXK	5 SC70	ACB	50	X5-1
MAX5464EXT	6 SC70	AAR	50	X6S-1
MAX5465EXT	6 SC70	AAS	50	X6S-1
MAX5466EUK	5 SOT23	ADQQ	10	U5-1
MAX5467EUT	6 SOT23	AARH	10	U6-1
MAX5468EUT	6 SOT23	AARI	10	U6-1

Note: All devices operate over the -40°C to +85°C temperature range.

Pin Configurations

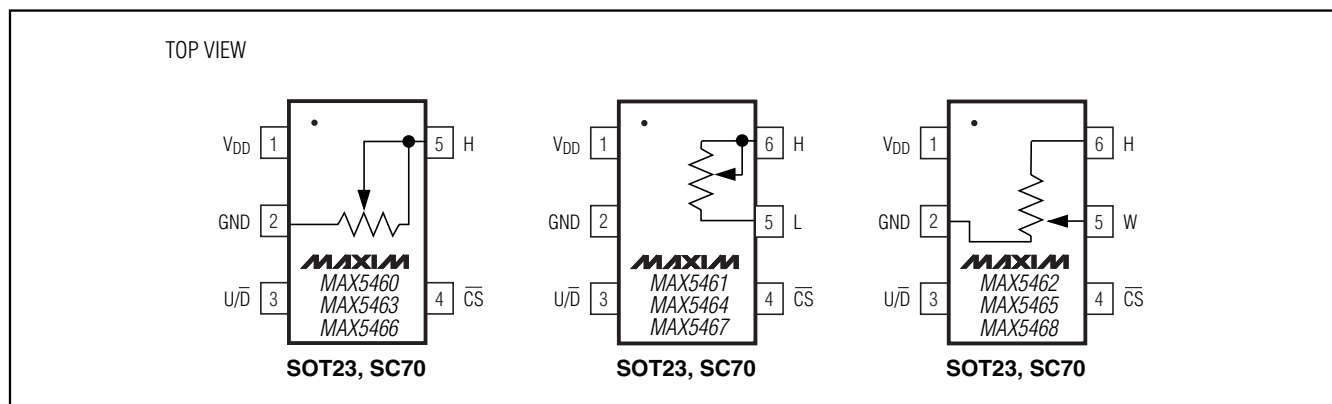

32-Tap FleaPoT™, 2-Wire Digital Potentiometers

ABSOLUTE MAXIMUM RATINGS

V _{DD} to GND	-0.3V to +6V
All Other Pins to GND	-0.3V to (V _{DD} + 0.3)V
Input and Output Latch-Up Immunity	±200mA
Maximum Continuous Current into H, L, and W	
MAX5460/MAX5461/MAX5462 (100kΩ)	±0.6mA
MAX5463/MAX5464/MAX5465 (50kΩ)	±1.3mA
MAX5466/MAX5467/MAX5468 (10kΩ)	±1.3mA

Continuous Power Dissipation (T _A = +70°C)	
5-pin SC70 (derate 3.1mW/°C above T _A = +70°C)	247mW
5-pin SOT23 (derate 7.1mW/°C above T _A = +70°C)	571mW
6-pin SC70 (derate 3.1mW/°C above T _A = +70°C)	245mW
6-pin SOT23 (derate 8.7mW/°C above T _A = +70°C)	695.7mW
Operating Temperature Range	-40°C to +85°C
Junction Temperature	+150°C
Storage Temperature Range	-65°C to +150°C
Soldering Temperature (soldering, 10s)	+300°C

Stresses beyond those listed under "Absolute Maximum Ratings" may cause permanent damage to the device. These are stress ratings only, and functional operation of the device at these or any other conditions beyond those indicated in the operational sections of the specifications is not implied. Exposure to absolute maximum rating conditions for extended periods may affect device reliability.

ELECTRICAL CHARACTERISTICS

(V_{DD} = +2.7V to +5.5V, V_H = V_{DD}, V_L = 0, T_A = -40°C to +85°C. Typical values are at V_{DD} = +2.7V, T_A = +25°C, unless otherwise noted.)

PARAMETER	SYMBOL	CONDITIONS	MIN	TYP	MAX	UNITS
DC PERFORMANCE						
Resolution			32			Taps
End-to-End Resistance		MAX5460/MAX5461/MAX5462	75	100	125	kΩ
		MAX5463/MAX5464/MAX5465	37.5	50	62.5	
		MAX5466/MAX5467/MAX5468	7.5	10	12.5	
End-to-End Resistance Tempco	TC _R			35		ppm/°C
Ratiometric Resistance Tempco				5		ppm/°C
Integral Nonlinearity	INL			±0.5	±1	LSB
Differential Nonlinearity	DNL				±1	LSB
Full-Scale Error				±0.1		LSB
Zero-Scale Error					1	LSB
Wiper Resistance	R _W	MAX5462/MAX5465		600	1200	Ω
		MAX5468		160	240	
DIGITAL INPUTS						
Input High Voltage	V _{IH}		0.7 × V _{DD}			V
Input Low Voltage	V _{IL}				0.3 × V _{DD}	V
TIMING CHARACTERISTICS (Figures 1, 2)						
U/ \bar{D} Mode to \bar{CS} Setup	t _{CU}		25			ns
\bar{CS} to U/ \bar{D} Step Setup	t _{CI}		50			ns
\bar{CS} to U/ \bar{D} Step Hold	t _{IC}		25			ns
U/ \bar{D} Step Low Period	t _{IL}		25			ns
U/ \bar{D} Step High Period	t _{IH}		25			ns
Up/Down Toggle Rate (Note 1)	f _{TOGGLE}			1		MHz
Output Settling Time (Note 2)	t _{SETTLE}	100kΩ variable resistor configuration, C _L = 10pF		1		μs
		100kΩ potentiometer configuration, C _L = 10pF		0.25		

32-Tap FleaPoT™, 2-Wire Digital Potentiometers

MAX5460-MAX5468

ELECTRICAL CHARACTERISTICS (continued)

($V_{DD} = +2.7V$ to $+5.5V$, $V_H = V_{DD}$, $V_L = 0$, $T_A = -40^{\circ}C$ to $+85^{\circ}C$. Typical values are at $V_{DD} = +2.7V$, $T_A = +25^{\circ}C$, unless otherwise noted.)

PARAMETER	SYMBOL	CONDITIONS	MIN	TYP	MAX	UNITS
POWER SUPPLIES						
Supply Voltage	V_{DD}		2.7		5.5	V
Active Supply Current (Note 3)	I_{DD}				25	μA
Standby Supply Current (Note 4)	I_{SD}	$V_{DD} = +5V$		0.3	1	μA

Note 1: Up/Down Toggle Rate:

$$f_{TOGGLE} = \frac{1}{t_{SETTLE}}$$

Note 2: Typical settling times are dependent on end-to-end resistance.

Note 3: Supply current taken while changing wiper tap, $f_{TOGGLE} = 1MHz$.

Note 4: Supply current taken while wiper position is fixed.

Typical Operating Characteristics

($T_A = +25^{\circ}C$, unless otherwise noted.)

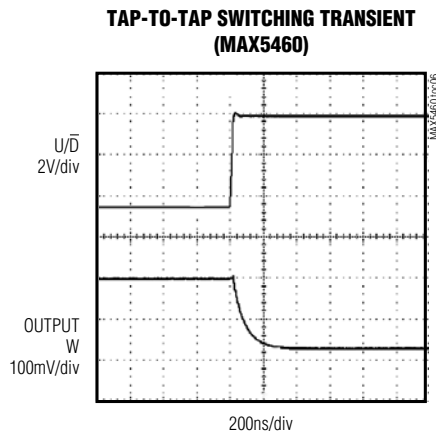
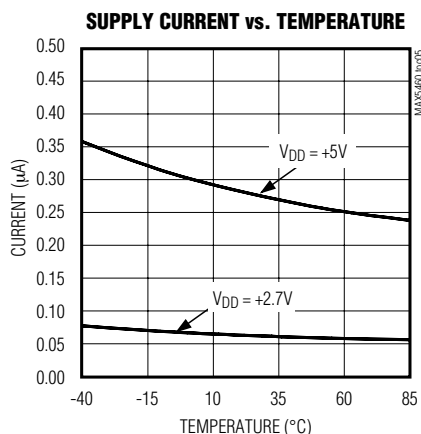
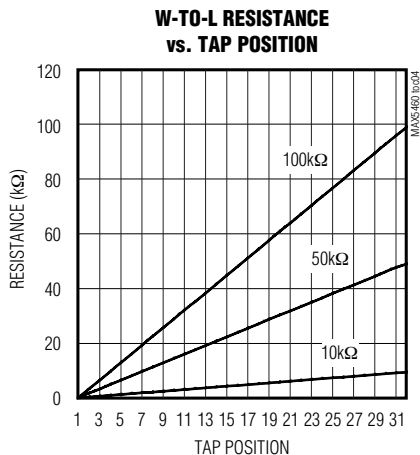
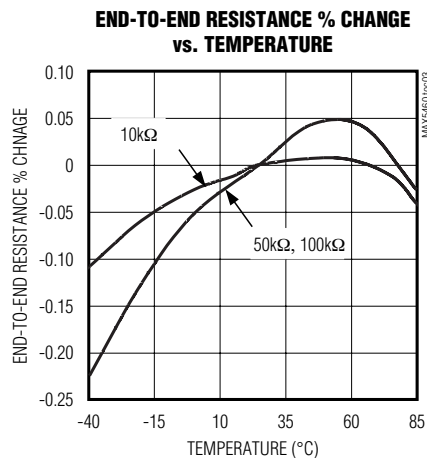
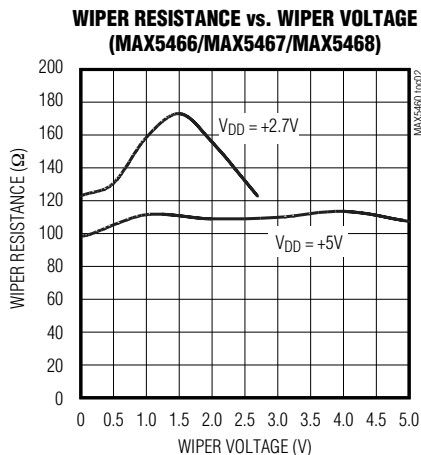

32-Tap FleaPoT™, 2-Wire Digital Potentiometers

Typical Operating Characteristics (continued)

(T_A = +25°C, unless otherwise noted.)

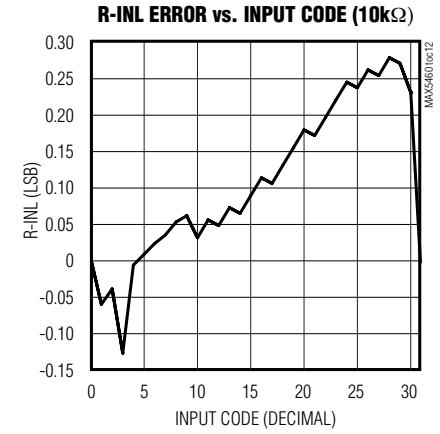
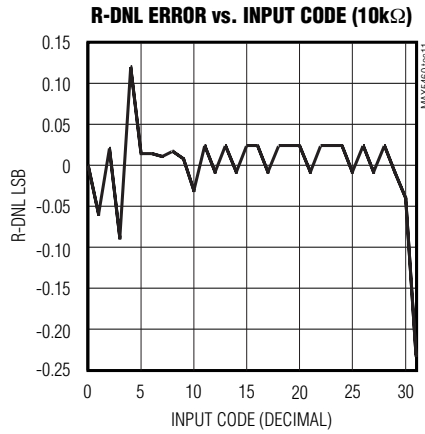
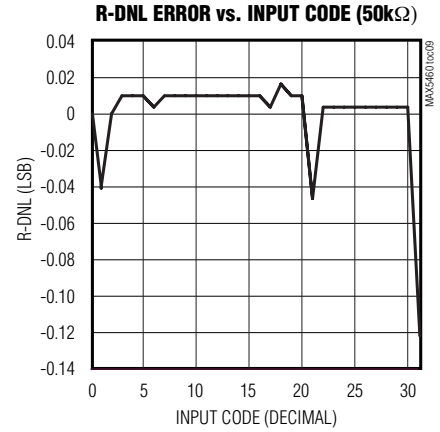
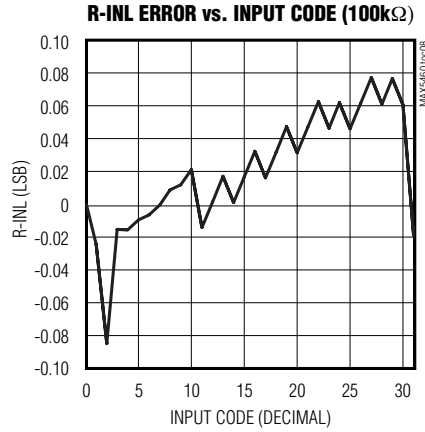

Pin Description

PIN			NAME	FUNCTION
MAX5460 MAX5463 MAX5466	MAX5461 MAX5464 MAX5467	MAX5462 MAX5465 MAX5468		
1	1	1	V _{DD}	Power Supply
2	2	2	GND	Ground
3	3	3	U/ \bar{D}	Up/ \bar{D} Control Input. With \bar{CS} low, a low-to-high transition increments or decrements the wiper position.
4	4	4	\bar{CS}	Chip Select Input. A high-to-low \bar{CS} transition determines the mode: increment if U/ \bar{D} is high, or decrement if U/ \bar{D} is low.
5	6	6	H	High Terminal of Resistor
—	5	—	L	Low Terminal of Resistor
—	—	5	W	Wiper Terminal of Resistor

32-Tap FleaPoT™, 2-Wire Digital Potentiometers

MAX5460–MAX5468

Detailed Description

The MAX5460–MAX5468 consist of a fixed resistor and a wiper contact with 32-tap points that are digitally controlled through a 2-wire serial interface. Three resistance values are available: 10kΩ (MAX5466/MAX5467/MAX5468), 50kΩ (MAX5463/MAX5464/MAX5465), and 100kΩ (MAX5460/MAX5461/MAX5462).

The MAX5462/MAX5465/MAX5468 are designed to operate as potentiometers. In this configuration, the low terminal of the resistor array is connected to ground (pin 2).

The MAX5461/MAX5464/MAX5467 perform as variable resistors. In these devices, the wiper terminal and high terminal of the resistor array are connected at pin 5. The MAX5460/MAX5463/MAX5466 are similar variable resistors, except the low terminal is connected to ground (pin 2).

Digital Interface Operation

The MAX5460–MAX5468 have two modes of operation when the serial interface is active: increment and decrement mode. The serial interface is only active when \overline{CS} is low.

The \overline{CS} and U/\overline{D} inputs control the position of the wiper along the resistor array. When \overline{CS} transitions from high to low, the part will go into increment mode if U/\overline{D} is high, and into decrement mode if U/\overline{D} is low. Once the mode is set, the device will remain in that mode until \overline{CS} goes high again. A low-to-high transition at the U/\overline{D} pin will increment or decrement the wiper position depending on the current mode (Figures 1 and 2).

When the \overline{CS} input transitions to high (serial interface inactive), the value of the counter is stored and the wiper position is maintained.

Note that when the wiper reaches the maximum (or minimum) tap position, the wiper will not wrap around to the minimum (or maximum) position.



Figure 1. Serial Interface Timing Diagram, Increment Mode



Figure 2. Serial Interface Timing Diagram, Decrement Mode

32-Tap FleaPoT™, 2-Wire Digital Potentiometers

Power-On Reset

All parts in this family feature power-on reset (POR) circuitry that sets the wiper position to midscale at power-up. By default, the chip is in the increment mode.

Applications Information

The MAX5460-MAX5468 are intended for circuits requiring digitally controlled adjustable resistance, such as LCD contrast control, where voltage biasing adjusts the display contrast.

Controlling a Switch-Mode LCD Bias Generator

Figure 3 shows an application where the variable resistor is used with a MAX1771 to make an adjustable positive LCD-bias circuit. The output of the MAX1771 is a positive voltage that is digitally controlled through the MAX5461/MAX5464/MAX5467. Similarly, Figure 4 shows the application of the variable resistor in a digitally controlled negative LCD-bias circuit along with the MAX774/MAX775/MAX776.

Alternative Positive LCD Bias Control

Alternatively, use an op amp to provide buffering and gain to the output of the MAX5462/MAX5465/MAX5468. Connect the mechanical potentiometer to the positive input of a noninverting op amp (Figure 5) to select a portion of the input signal by digitally controlling the wiper terminal. Figure 6 shows a similar circuit for the MAX5461/MAX5464/MAX5467.

Adjustable Gain

Figure 7 shows how to use the variable resistor to digitally adjust the gain of a noninverting op amp configuration. Connect the MAX5461/MAX5464/MAX5467 in series with a resistor to ground to form the adjustable gain control of a noninverting amplifier. The MAX5460-MAX5468 have a low 5ppm/°C ratiometric tempco that allows for a very stable adjustable gain configuration over temperature.



Figure 3. Adjustable Positive LCD Bias



Figure 4. Adjustable Negative LCD Bias

32-Tap FleaPoT™, 2-Wire Digital Potentiometers

MAX5460-MAX5468



Figure 5. Positive LCD Bias Control



Figure 6. Positive LCD Bias Control



Figure 7. Adjustable Gain Circuit

32-Tap FleaPoT™, 2-Wire Digital Potentiometers

Functional Diagram



Chip Information

TRANSISTOR COUNT: 792

32-Tap FleaPoT™, 2-Wire Digital Potentiometers

Package Information

(The package drawing(s) in this data sheet may not reflect the most current specifications. For the latest package outline information go to www.maxim-ic.com/packages.)

MAX5460-MAX5468

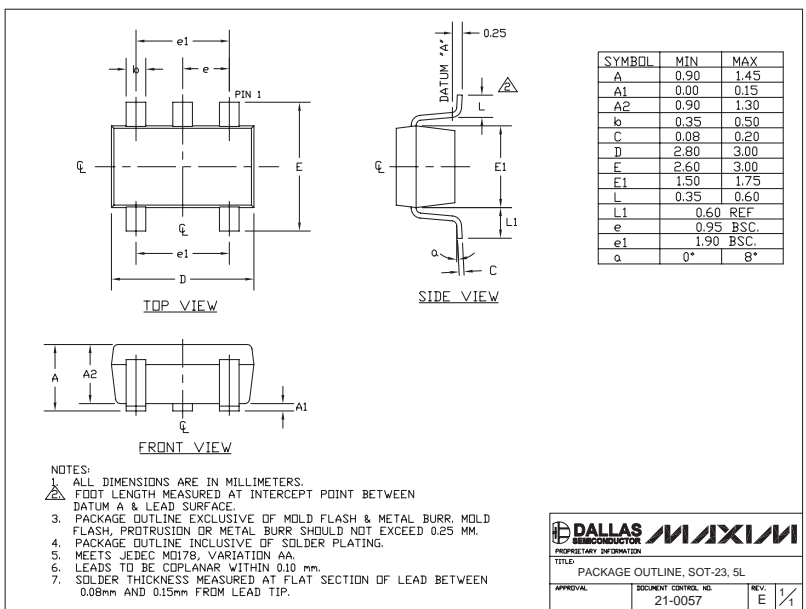

32-Tap FleaPoT™, 2-Wire Digital Potentiometers

Package Information (continued)

(The package drawing(s) in this data sheet may not reflect the most current specifications. For the latest package outline information go to www.maxim-ic.com/packages.)



6L SOT663



6L SOT70

Maxim cannot assume responsibility for use of any circuitry other than circuitry entirely embodied in a Maxim product. No circuit patent licenses are implied. Maxim reserves the right to change the circuitry and specifications without notice at any time.

10 Maxim Integrated Products, 120 San Gabriel Drive, Sunnyvale, CA 94086 408-737-7600