

Features

- N-Channel, 5V Logic Level Control
- Enhancement mode
- Low on-resistance $R_{DS(on)}$ @ $V_{GS}=4.5\text{ V}$
- VitoMOS[®] II Technology
- 100% Avalanche test
- Pb-free lead plating; RoHS compliant

Halogen-Free

| Part ID | Package Type | Marking | Tape and reel information |
|-------------|--------------|---------|---------------------------|
| VSO008N10MS | SOP8 | 008N10M | 3000PCS/Reel |

| | | |
|----------------------------------------|-----|------------|
| V_{DS} | 100 | V |
| $R_{DS(on),TYP} @ V_{GS}=10\text{ V}$ | 6.4 | m Ω |
| $R_{DS(on),TYP} @ V_{GS}=4.5\text{ V}$ | 10 | m Ω |
| I_D | 17 | A |

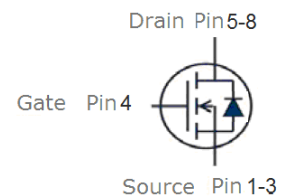

Maximum ratings, at $T_A = 25^\circ\text{C}$, unless otherwise specified

| Symbol | Parameter | Rating | Unit |
|----------------|------------------------------------------------|---------------------------|------------------|
| $V_{(BR)DSS}$ | Drain-Source breakdown voltage | 100 | V |
| V_{GS} | Gate-Source voltage | ± 20 | V |
| I_S | Diode continuous forward current | $T_A = 25^\circ\text{C}$ | 2.6 A |
| I_D | Continuous drain current @ $V_{GS}=10\text{V}$ | $T_A = 25^\circ\text{C}$ | 17 A |
| | | $T_A = 100^\circ\text{C}$ | 11 A |
| I_{DM} | Pulse drain current tested ① | $T_A = 25^\circ\text{C}$ | 68 A |
| EAS | Avalanche energy, single pulsed ② | 104 | mJ |
| P_D | Maximum power dissipation | $T_A = 25^\circ\text{C}$ | 3.1 W |
| MSL | | Level 3 | |
| T_{STG}, T_J | Storage and Junction Temperature Range | -55 to 150 | $^\circ\text{C}$ |

Thermal Characteristics

| Symbol | Parameter | Typical | Unit |
|-----------------|-----------------------------------------|---------|--------------------|
| $R_{\theta JL}$ | Thermal Resistance, Junction-to-Lead | 24 | $^\circ\text{C/W}$ |
| $R_{\theta JA}$ | Thermal Resistance, Junction-to-Ambient | 40 | $^\circ\text{C/W}$ |

Electrical Characteristics

| Symbol | Parameter | Condition | Min. | Typ. | Max. | Unit |
|---------------------------------------------------------------------------------------------|--------------------------------------------------------|------------------------------------------------------------------------------------------------|------|------|------|------|
| Static Electrical Characteristics @ T_j=25°C (unless otherwise stated) | | | | | | |
| V _{(BR)DSS} | Drain-Source Breakdown Voltage | V _{GS} =0V, I _D =250μA | 100 | -- | -- | V |
| I _{DSS} | Zero Gate Voltage Drain Current | V _{DS} =100V, V _{GS} =0V | -- | -- | 1 | μA |
| | Zero Gate Voltage Drain Current(T _j =125°C) | V _{DS} =100V, V _{GS} =0V | -- | -- | 100 | μA |
| I _{GSS} | Gate-Body Leakage Current | V _{GS} =±20V, V _{DS} =0V | -- | -- | ±100 | nA |
| V _{GS(TH)} | Gate Threshold Voltage | V _{DS} =V _{GS} , I _D =250μA | 1.3 | 1.8 | 2.3 | V |
| R _{DS(ON)} | Drain-Source On-State Resistance ^③ | V _{GS} =10V, I _D =10A | -- | 6.4 | 8 | mΩ |
| R _{DS(ON)} | Drain-Source On-State Resistance ^③ | V _{GS} =4.5V, I _D =6A | -- | 10 | 12 | mΩ |
| Dynamic Electrical Characteristics @ T_j = 25°C (unless otherwise stated) | | | | | | |
| C _{iss} | Input Capacitance | V _{DS} =30V, V _{GS} =0V, f=1MHz | 2250 | 2645 | 3050 | pF |
| C _{oss} | Output Capacitance | | 980 | 1155 | 1305 | pF |
| C _{rss} | Reverse Transfer Capacitance | | 25 | 35 | 45 | pF |
| R _g | Gate Resistance | f=1MHz | -- | 3.1 | -- | Ω |
| Q _g (10V) | Total Gate Charge | V _{DS} =50V, I _D =10A, V _{GS} =10V | -- | 45 | -- | nC |
| Q _g (4.5V) | Total Gate Charge | | -- | 23 | -- | nC |
| Q _{gs} | Gate-Source Charge | | -- | 8 | -- | nC |
| Q _{gd} | Gate-Drain Charge | | -- | 9 | -- | nC |
| Switching Characteristics | | | | | | |
| t _{d(on)} | Turn-on Delay Time | V _{DD} =50V, I _D =10A, R _G =3.0Ω, V _{GS} =10V | -- | 11.7 | -- | ns |
| t _r | Turn-on Rise Time | | -- | 7.2 | -- | ns |
| t _{d(off)} | Turn-Off Delay Time | | -- | 34.5 | -- | ns |
| t _f | Turn-Off Fall Time | | -- | 12.3 | -- | ns |
| Source- Drain Diode Characteristics @ T_j = 25°C (unless otherwise stated) | | | | | | |
| V _{SD} | Forward on voltage | I _{SD} =10A, V _{GS} =0V | -- | 0.8 | 1.2 | V |
| t _{rr} | Reverse Recovery Time | T _j =25°C, I _{SD} =10A, V _{GS} =0V | -- | 21.6 | -- | ns |
| Q _{rr} | Reverse Recovery Charge | di/dt=500A/μs | -- | 44.7 | -- | nC |

NOTE:

- ① Repetitive rating; pulse width limited by max junction temperature.
- ② Limited by T_{Jmax}, starting T_J = 25°C, L = 0.5mH, R_G = 25Ω, I_{AS} = 16A, V_{GS} = 10V. Part not recommended for use above this value
- ③ Pulse width ≤ 300μs; duty cycle ≤ 2%.

Typical Characteristics

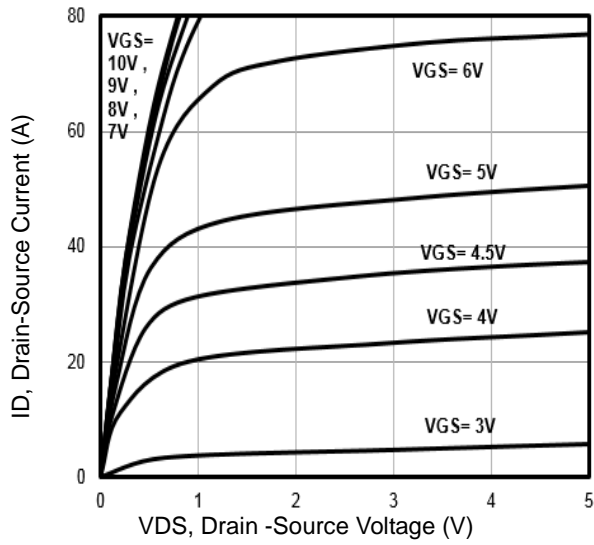

Fig1. Typical Output Characteristics

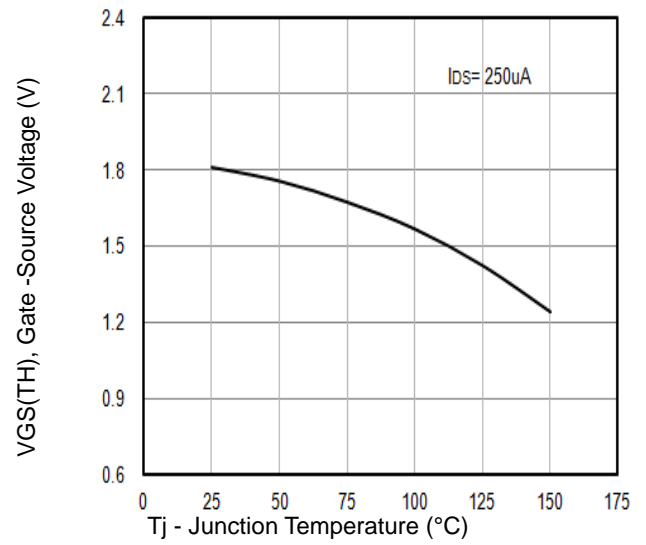

Fig2. $V_{GS(TH)}$ Gate-Source Voltage Vs. T_j

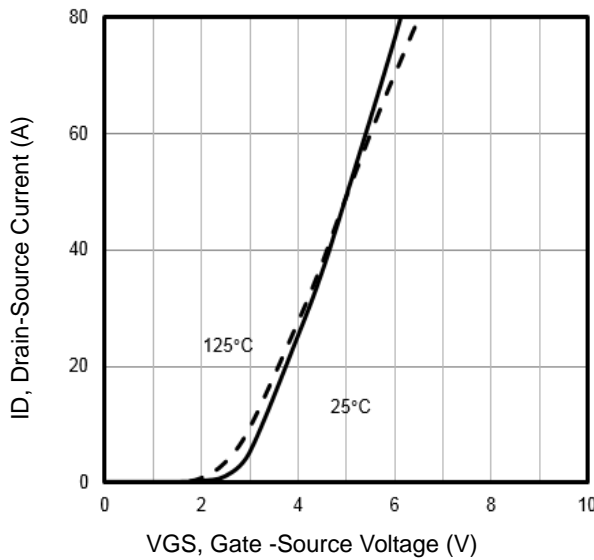

Fig3. Typical Transfer Characteristics

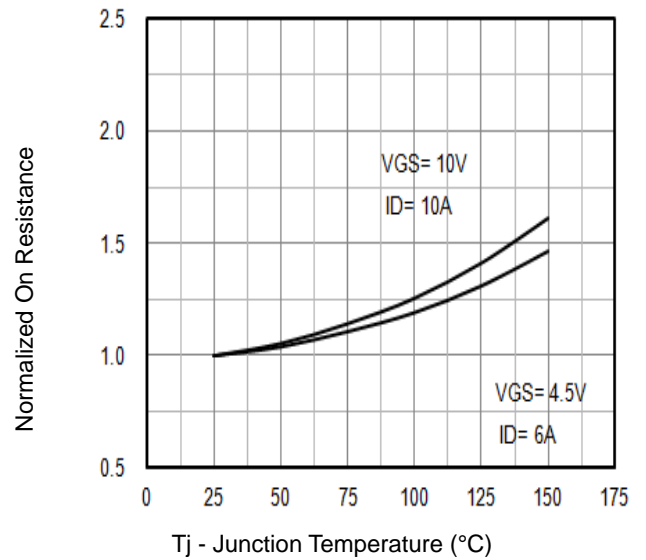

Fig4. Normalized On-Resistance Vs. T_j

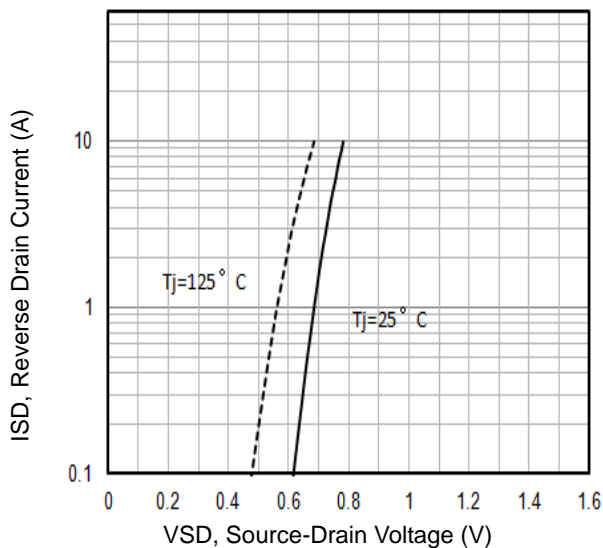

Fig5. Typical Source-Drain Diode Forward Voltage

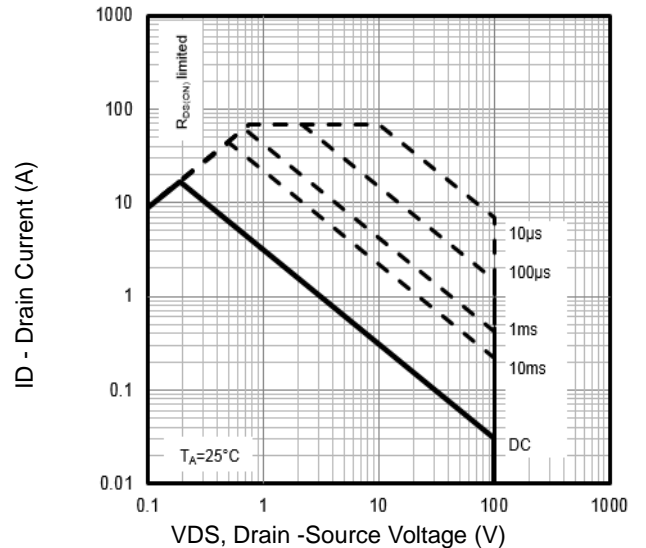

Fig6. Maximum Safe Operating Area

Typical Characteristics

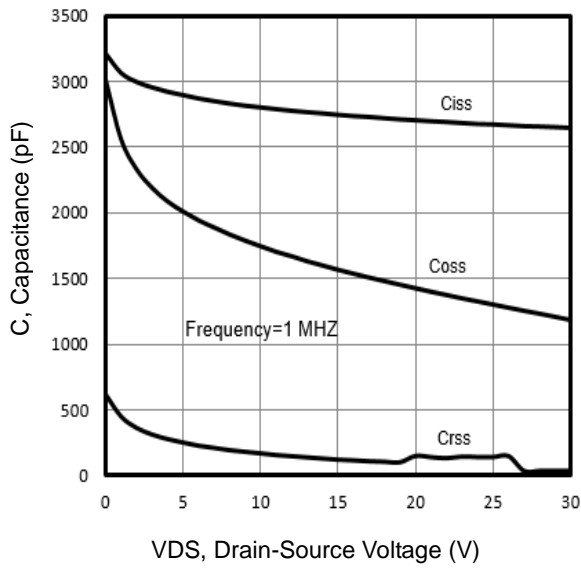

Fig7. Typical Capacitance Vs. Drain-Source Voltage

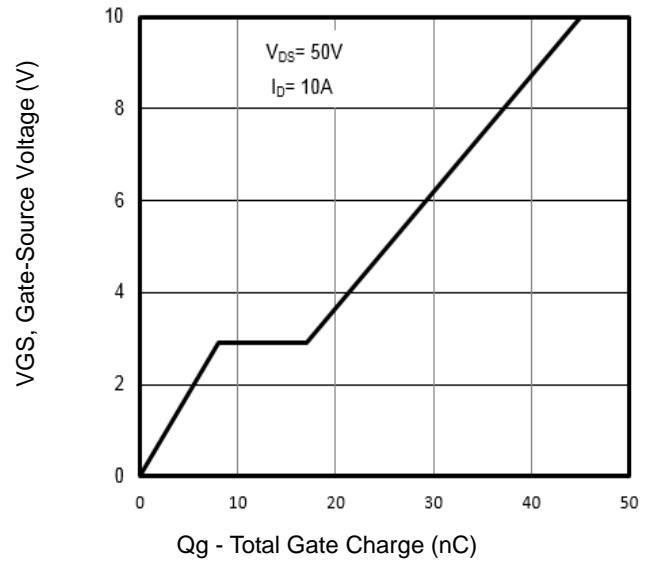

Fig8. Typical Gate Charge Vs. Gate-Source Voltage

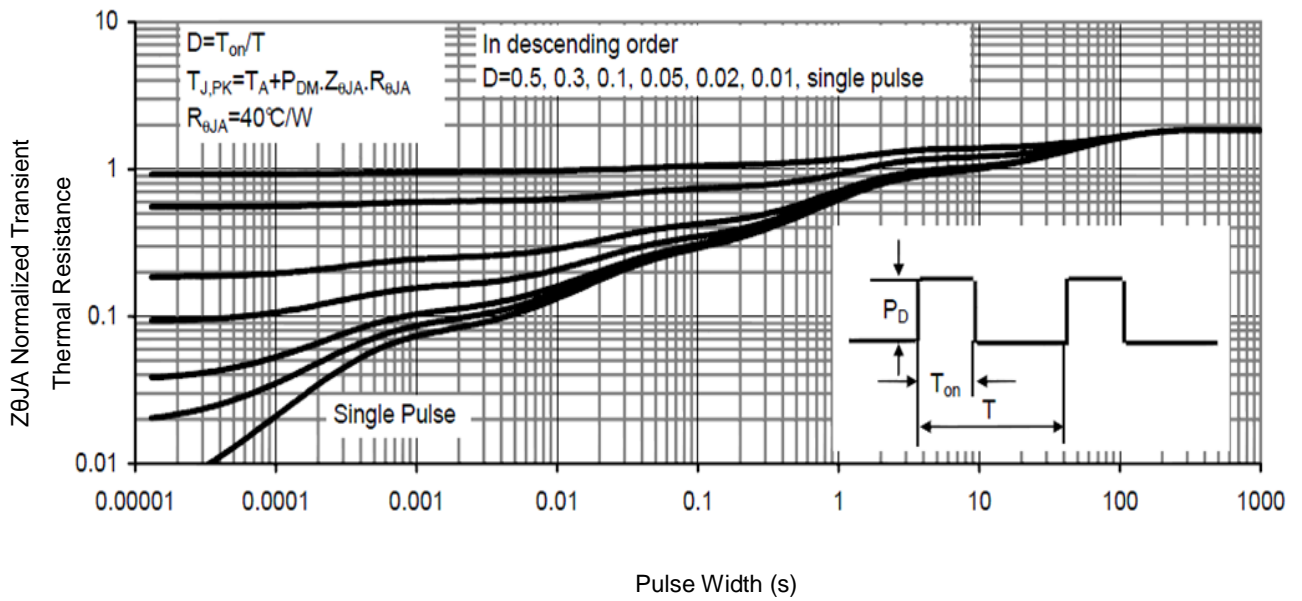

Fig9. Normalized Maximum Transient Thermal Impedance

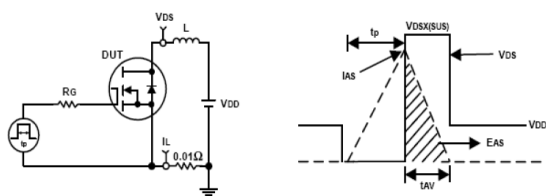

Fig10. Unclamped Inductive Test Circuit and waveforms

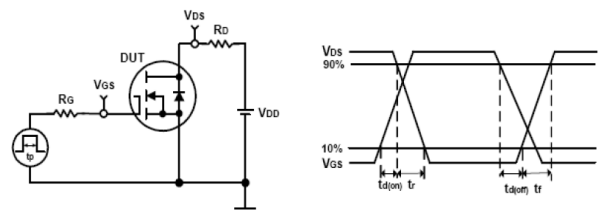
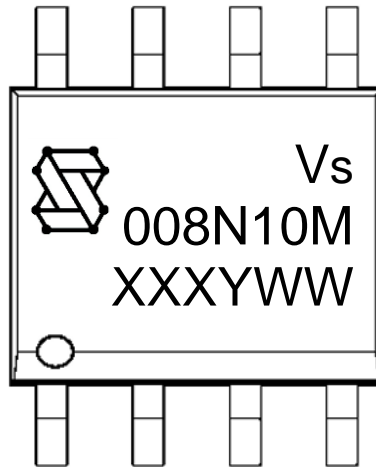

Fig11. Switching Time Test Circuit and waveforms

Marking Information



1st line: Vanguard Code (Vs), Vanguard Logo

2nd line: Part Number (008N10M)

3rd line: Date code (XXXYWW)

XXX: Wafer Lot Number Code, code changed with Lot Number

Y: Year Code, (e.g. E=2017, F=2018, G=2019, H=2020, etc)

WW: Week Code (01 to 53)

SOP8 Package Outline Data

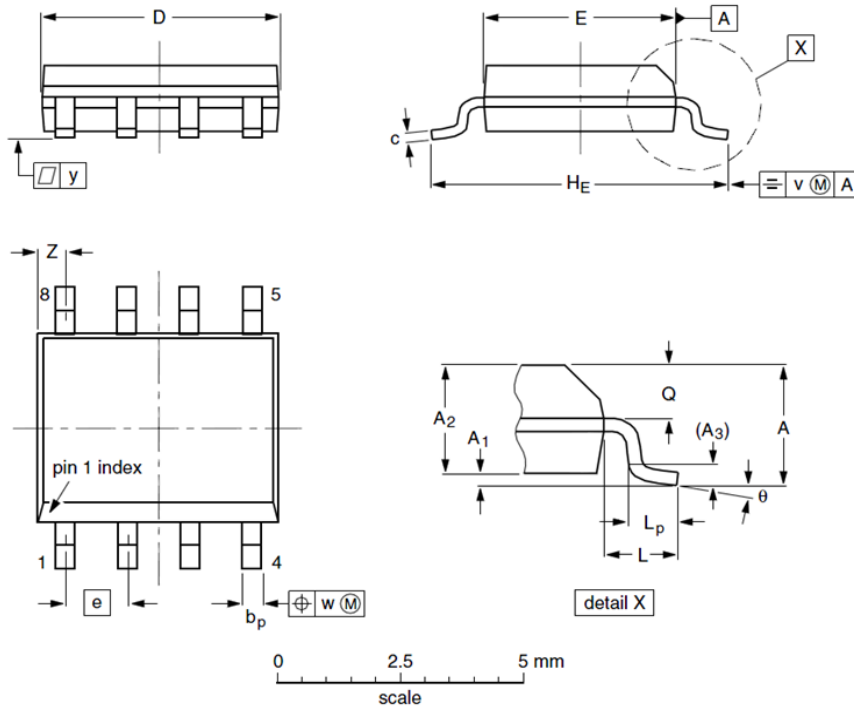

| Label | Dimensions (unit: mm) | | |
|----------------|-----------------------|------|-------|
| | Min | Typ | Max |
| A | -- | -- | 1.75 |
| A ₁ | 0.10 | 0.18 | 0.25 |
| A ₂ | 1.25 | 1.35 | 1.50 |
| A ₃ | -- | 0.25 | -- |
| b _p | 0.36 | 0.42 | 0.51 |
| c | 0.19 | 0.22 | 0.25 |
| D | 4.80 | 4.92 | 5.00 |
| E | 3.80 | 3.90 | 4.00 |
| e | -- | 1.27 | -- |
| H _E | 5.80 | 6.00 | 6.20 |
| L | -- | 1.05 | -- |
| L _p | 0.40 | 0.68 | 1.00 |
| Q | 0.60 | 0.65 | 0.725 |
| v | -- | 0.25 | -- |
| w | -- | 0.25 | -- |
| y | -- | 0.10 | -- |
| Z | 0.30 | 0.50 | 0.70 |
| θ | 0° | | 8° |

Notes:

1. Follow JEDEC MS-012.
2. Dimension "D" does NOT include mold flash, protrusions or gate burrs. Mold flash, protrusions or gate burrs shall not exceed 0.15mm per side.
3. Dimension "E" does NOT include interlead flash or protrusion. Interlead flash or protrusion shall not exceed 0.25mm per side.
4. Dimension "b_p" does NOT include dambar protrusion. Allowable dambar protrusion shall be 0.1mm total in excess of "b_p" dimension at maximum material condition. The dambar cannot be located on the lower radius of the foot.

Customer Service

Sales and Service:

sales@vgsemi.com

Vanguard Semiconductor CO., LTD

TEL: (86-755) -26902410

FAX: (86-755) -26907027

WEB: www.vgsemi.com