



UT3401Z

Power MOSFET

P-CHANNEL ENHANCEMENT MODE

DESCRIPTION

The UTC **UT3401Z** is P-channel enhancement mode Power MOSFET, designed with high density cell, with fast switching speed, low on-resistance, excellent thermal and electrical capabilities and operation with low gate voltages.

This device is suitable for use as a load switch or in PWM applications.

SYMBOL

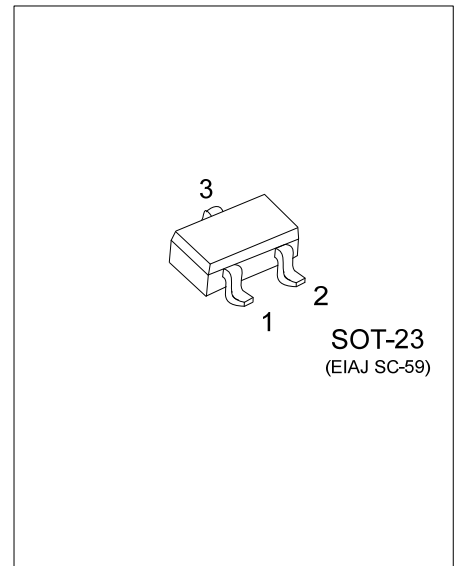
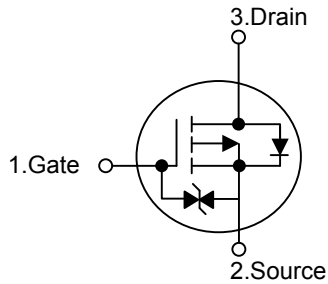

ORDERING INFORMATION

Ordering Number		Package	Pin Assignment			Packing
Lead Free	Halogen Free		1	2	3	
UT3401ZL-AE3-R	UT3401ZG-AE3-R	SOT-23	G	S	D	Tape Reel

Note: Pin Assignment: G: Gate S: Source D: Drain

<p>UT3401ZG-AE3-R</p> <p>(1) Packing Type (2) Package Type (3) Green Package</p>	<p>(1) R: Tape Reel (2) AE3: SOT-23 (3) G: Halogen Free and Lead Free, L: Lead Free</p>
--	---

MARKING

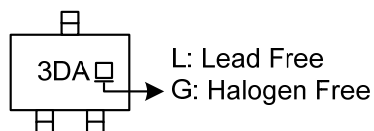

■ ABSOLUTE MAXIMUM RATINGS ($T_A=25^{\circ}\text{C}$, unless otherwise specified)

PARAMETER	SYMBOL	RATINGS	UNITS	
Drain-Source Voltage	V_{DSS}	-30	V	
Gate-Source Voltage	V_{GSS}	± 12	V	
Drain Current	Continuous (Note2)	I_D	-4.2	A
	Pulsed (Note3)	I_{DM}	-30	A
Power Dissipation (Note 2)	P_D	1.4	W	
ESD(HBM)	ESD	± 100	V	
Junction Temperature	T_J	+150	$^{\circ}\text{C}$	
Storage Temperature	T_{STG}	-55 ~ +150	$^{\circ}\text{C}$	

Notes: 1. Absolute maximum ratings are those values beyond which the device could be permanently damaged.

Absolute maximum ratings are stress ratings only and functional device operation is not implied.

2. Repetitive Rating : Pulse width limited by maximum junction temperature.

3. Pulse width $\leq 300\mu\text{s}$, duty cycle $\leq 2\%$.

■ THERMAL CHARACTERISTICS

PARAMETER	SYMBOL	MIN	TYP	MAX	UNIT
Junction to Ambient	θ_{JA}		65	90	$^{\circ}\text{C/W}$

■ ELECTRICAL CHARACTERISTICS ($T_A=25^{\circ}\text{C}$, unless otherwise specified)

PARAMETER	SYMBOL	TEST CONDITIONS	MIN	TYP	MAX	UNIT
OFF CHARACTERISTICS						
Drain-Source Breakdown Voltage	BV_{DSS}	$I_D=-250\mu\text{A}$, $V_{GS}=0\text{V}$	-30			V
Drain-Source Leakage Current	I_{DSS}	$V_{DS}=-24\text{V}$, $V_{GS}=0\text{V}$			-1	μA
Gate-Source Leakage Current	I_{GSS}	$V_{DS}=0\text{V}$, $V_{GS}=\pm 12\text{V}$			± 5	μA
ON CHARACTERISTICS						
Gate Threshold Voltage	$V_{GS(TH)}$	$V_{DS}=V_{GS}$, $I_D=-250\mu\text{A}$	-0.7	-1	-1.3	V
Drain-Source On-State Resistance (Note 2)	$R_{DS(ON)}$	$V_{GS}=-10\text{V}$, $I_D=-4.2\text{A}$		42	50	$\text{m}\Omega$
		$V_{GS}=-4.5\text{V}$, $I_D=-4\text{A}$		53	65	$\text{m}\Omega$
		$V_{GS}=-2.5\text{V}$, $I_D=-1\text{A}$		80	120	$\text{m}\Omega$
DYNAMIC PARAMETERS						
Input Capacitance	C_{ISS}	$V_{GS}=0\text{V}$, $V_{DS}=-15\text{V}$, $f=1\text{MHz}$		954		pF
Output Capacitance	C_{OSS}			115		pF
Reverse Transfer Capacitance	C_{RSS}			77		pF
SWITCHING PARAMETERS						
Total Gate Charge (Note 2)	Q_G	$V_{GS}=-4.5\text{V}$, $V_{DS}=-15\text{V}$, $I_D=-4\text{A}$		9.4		nC
Gate-Source Charge	Q_{GS}			2		nC
Gate-Drain Charge	Q_{GD}			3		nC
Turn-ON Delay Time (Note 2)	$t_{D(ON)}$	$V_{GS}=-10\text{V}$, $V_{DS}=-15\text{V}$ $R_L=3.6\Omega$, $R_G=6\Omega$		6.3		ns
Turn-ON Rise Time	t_R			3.2		ns
Turn-OFF Delay Time	$t_{D(OFF)}$			38.2		ns
Turn-OFF Fall Time	t_F			12		ns
SOURCE- DRAIN DIODE RATINGS AND CHARACTERISTICS						
Maximum Continuous Drain-Source Diode Forward Current	I_S				-2.2	A
Drain-Source Diode Forward Voltage(Note2)	V_{SD}	$V_{DS}=0\text{V}$, $I_S=-1\text{A}$		-0.75	-1	V
Reverse Recovery Time	t_{rr}	$I_F=-4\text{A}$, $dI/dt=100\text{A}/\mu\text{s}$		20.2		ns
Reverse Recovery Charge	Q_{rr}			11.2		nC

Notes: 1. Repetitive Rating : Pulse width limited by maximum junction temperature.

2. Pulse width $\leq 300\mu\text{s}$, duty cycle $\leq 2\%$

3. Surface mounted on 1 in^2 copper pad of FR4 board

TYPICAL CHARACTERISTICS

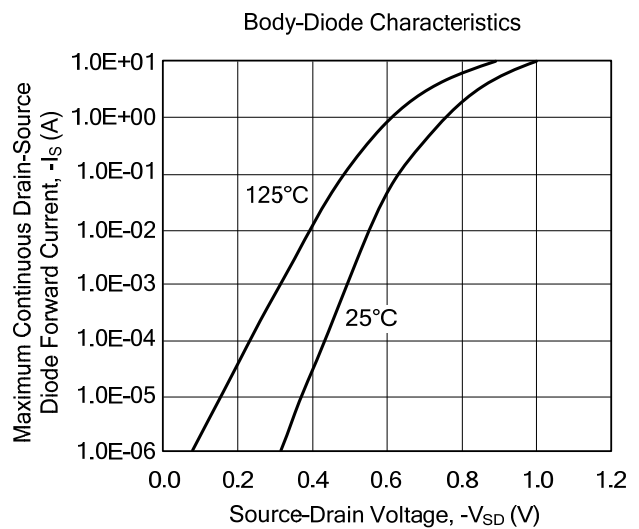
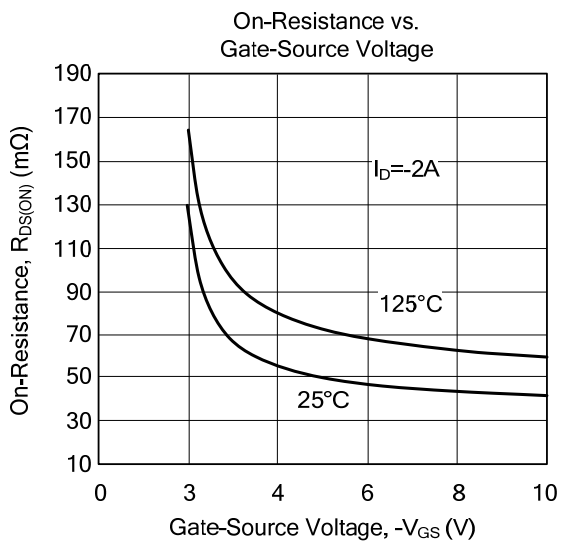
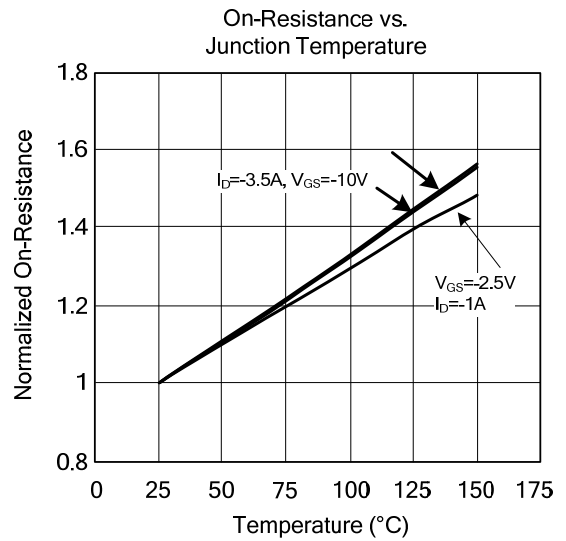
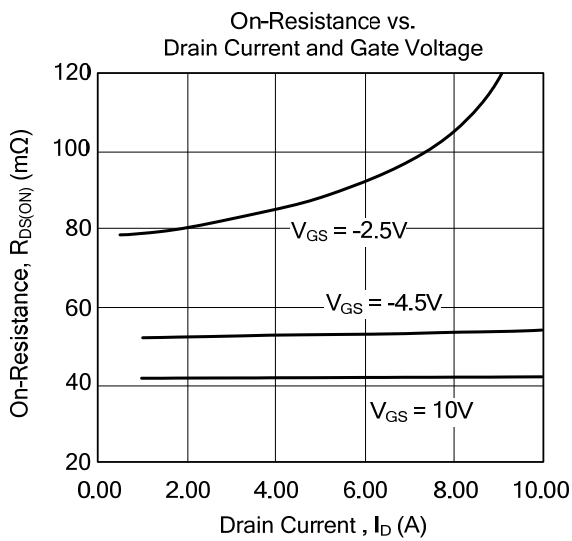
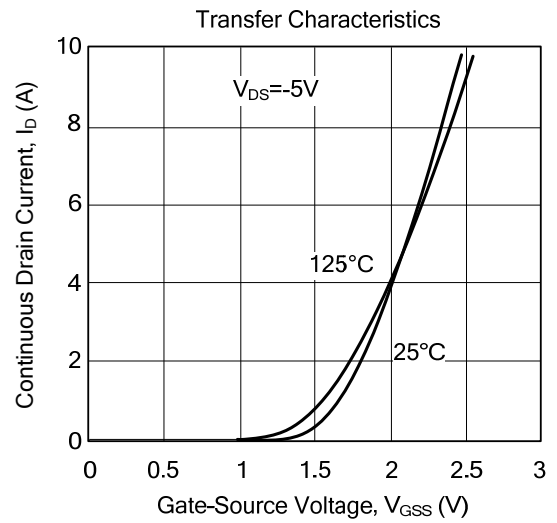
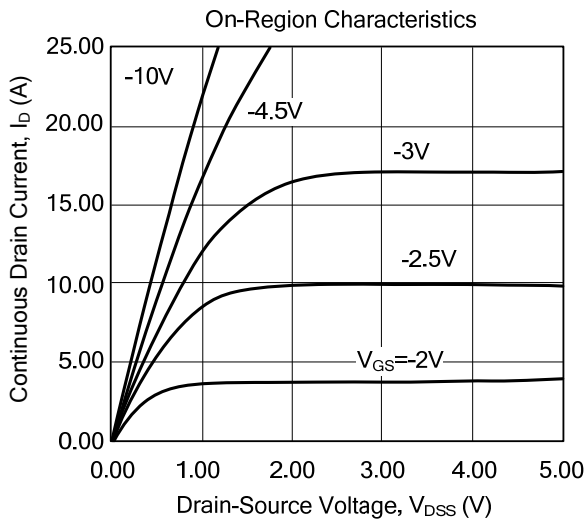

TYPICAL CHARACTERISTICS (Cont.)

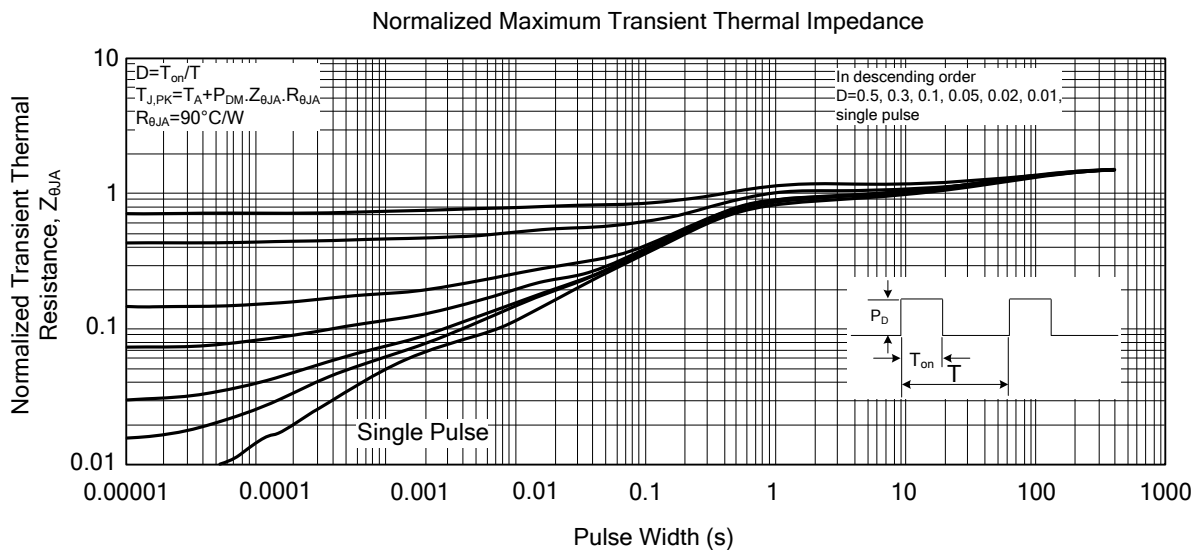
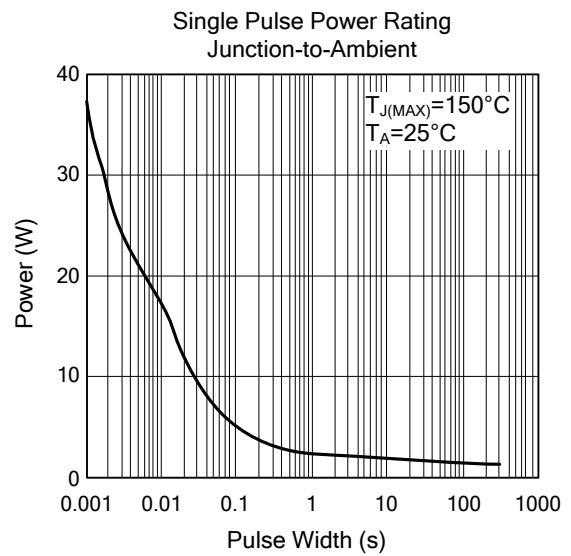
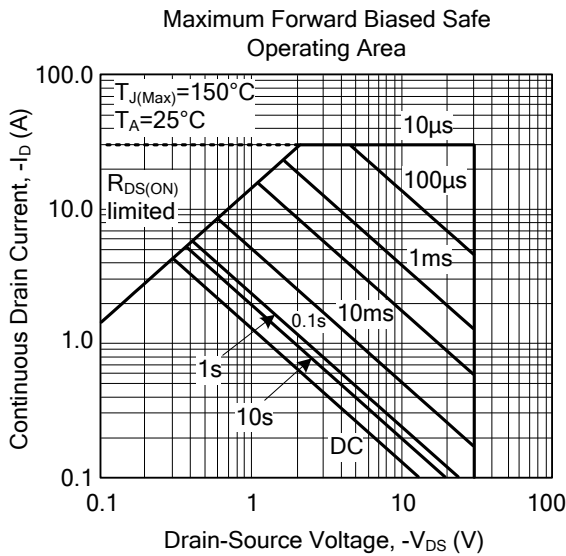
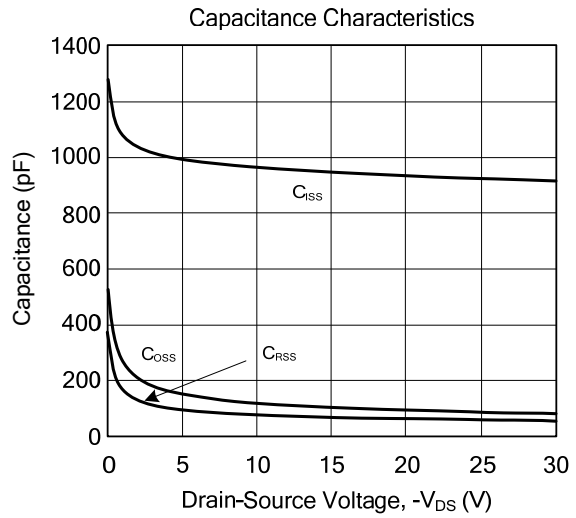
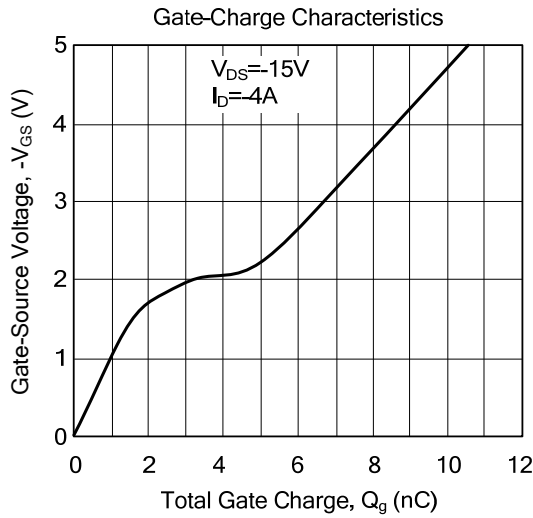

UTC assumes no responsibility for equipment failures that result from using products at values that exceed, even momentarily, rated values (such as maximum ratings, operating condition ranges, or other parameters) listed in products specifications of any and all UTC products described or contained herein. UTC products are not designed for use in life support appliances, devices or systems where malfunction of these products can be reasonably expected to result in personal injury. Reproduction in whole or in part is prohibited without the prior written consent of the copyright owner. UTC reserves the right to make changes to information published in this document, including without limitation specifications and product descriptions, at any time and without notice. This document supersedes and replaces all information supplied prior to the publication hereof.