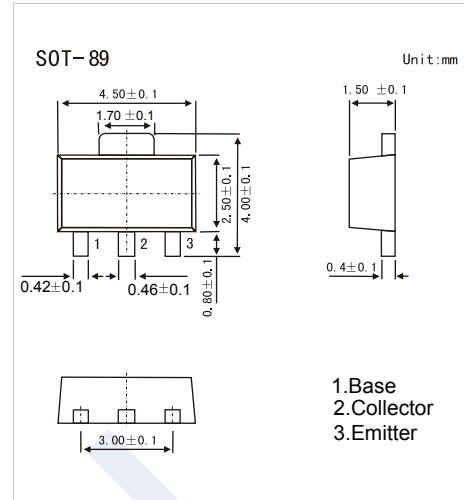

## NPN Transistors

## H8050

## ■ Features

- Collector Power Dissipation:  $P_c=1W$
- Collector Current:  $I_c=1.5A$
- Complementary to H8550

■ Absolute Maximum Ratings  $T_a = 25^\circ C$ 

Parameter	Symbol	Rating	Unit
Collector-base voltage	$V_{CB0}$	40	V
Collector-emitter voltage	$V_{CE0}$	25	V
Emitter-base voltage	$V_{EB0}$	5	V
Collector current	$I_c$	1.5	A
Collector power dissipation	$P_c$	1	W
Junction temperature	$T_j$	150	$^\circ C$
Storage temperature	$T_{stg}$	-55 to +150	$^\circ C$

■ Electrical Characteristics  $T_a = 25^\circ C$ 

Parameter	Symbol	Test conditions	Min	Typ	Max	Unit
Collector-base breakdown voltage	$V_{CB0}$	$I_c = 100 \mu A, I_E = 0$	40			V
Collector-emitter breakdown voltage	$V_{CE0}$	$I_c = 0.1mA, I_B = 0$	25			V
Emitter-base breakdown voltage	$V_{EB0}$	$I_E = 100 \mu A, I_c = 0$	5			V
Collector cut-off current	$I_{CBO}$	$V_{CB} = 40V, I_E = 0$			0.1	$\mu A$
Collector cut-off current	$I_{CEO}$	$V_{CE} = 20V, I_B = 0$			0.1	$\mu A$
Emitter cut-off current	$I_{EBO}$	$V_{EB} = 5V, I_c = 0$			0.1	$\mu A$
DC current gain	$h_{FE}$	$V_{CE} = 1V, I_c = 100mA$	85		400	
		$V_{CE} = 1V, I_c = 800mA$	40			
Collector-emitter saturation voltage	$V_{CE(sat)}$	$I_c = 800mA, I_B = 80mA$			0.5	V
Base-emitter saturation voltage	$V_{BE(sat)}$	$I_c = 800mA, I_B = 80mA$			1.2	V
Base-emitter on voltage	$V_{BE(on)}$	$I_c = 1V, V_{CE} = 10mA$			1	V
Base-emitter positive forward voltage	$V_{BEF}$	$I_B = 1A$			1.55	V
output capacitance	$C_{ob}$	$V_{CB} = 10V, I_E = 0, f = 1MHz$			15	pF
Transition frequency	$f_T$	$V_{CE} = 10V, I_c = 50mA$	100			MHz

■ Classification of  $h_{FE}(1)$ 

Type	H8050-B	H8050-C	H8050-D	H8050-D3
Range	85-160	120-200	160-300	300-400
Marking	8050B	8050C	8050D	8050D3

# H8050

## Typical Characteristics

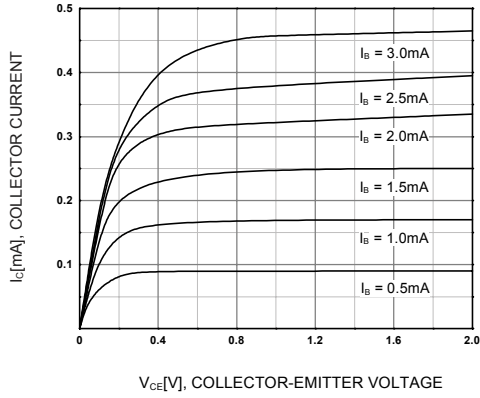

Figure 1. Static Characteristic

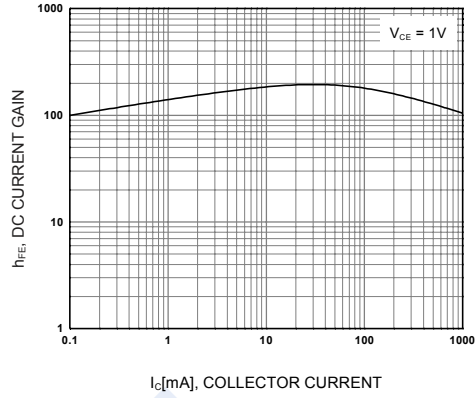

Figure 2. DC current Gain

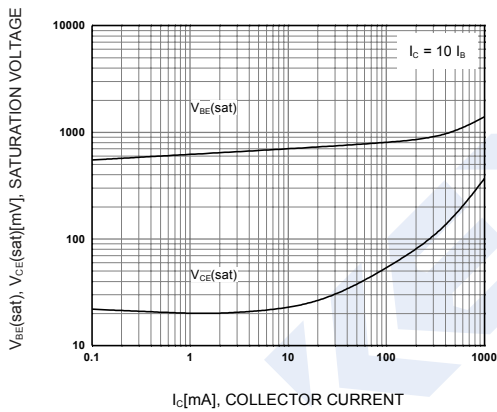

Figure 3. Base-Emitter Saturation Voltage  
Collector-Emitter Saturation Voltage

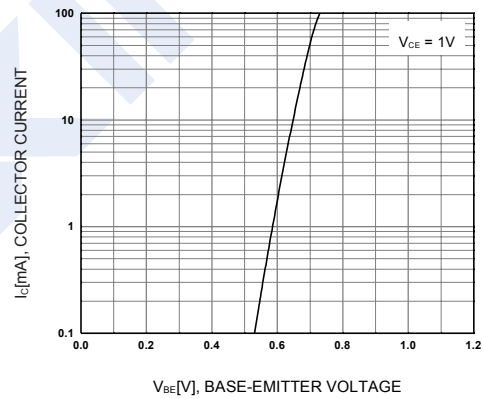

Figure 4. Base-Emitter On Voltage

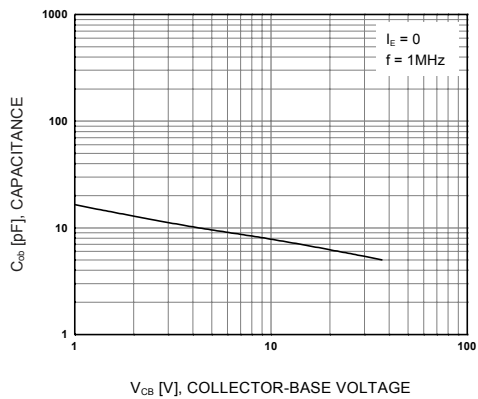

Figure 5. Collector Output Capacitance

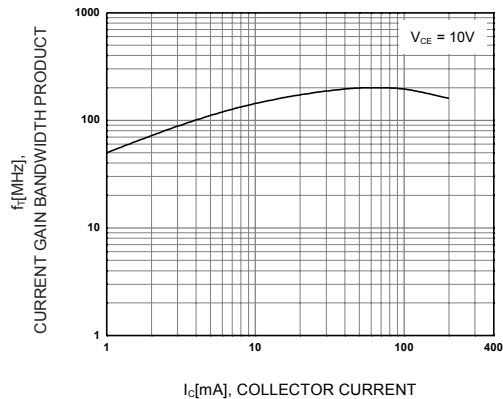

Figure 6. Current Gain Bandwidth Product