

General Description

The SM8103E is a high efficiency, 500kHz synchronous step-down DC/DC regulator capable of delivering up to 3A load current. It can operate over a wide input voltage range from 4.5V to 18V and integrate main switch and synchronous switch with very low $R_{DS(ON)}$ to minimize the conduction loss.

The SM8103E adopts the instant PWM architecture to achieve fast transient responses for high step down applications. In addition, it operates at pseudo-constant frequency of 500kHz to minimize the size of the inductor and the capacitor.

Ordering Information

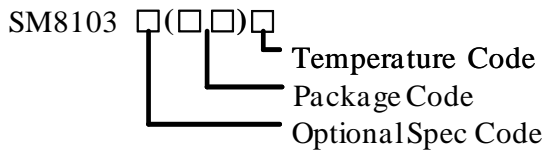

Ordering Number	Package type	Note
SM8103EADC	TSOT23-6	----

Features

- Low $R_{DS(ON)}$ for Internal Switches (Top/Bottom): 90mΩ/50mΩ
- 4.5-18V Input Voltage Range
- 3A Output Current Capability
- 500kHz Switching Frequency Minimize the External Components
- Stable with 10 μF C_{OUT} and 2.2 μH Inductor
- Instant PWM Architecture to Achieve Fast Transient Responses
- Internal Soft-start Limits the Inrush Current
- Forced PWM Operation
- Cycle-by-cycle Peak/Valley Current Limitation
- Hic-cup Mode Output Short Circuit Protection
- Thermal Shutdown with Auto Recovery
- Output Auto Discharge Function
- Compact Package: TSOT23-6

Applications

- Set Top Box
- Portable TV
- DSL Modem
- LCD TV
- IP CAM
- Networking

Typical Application

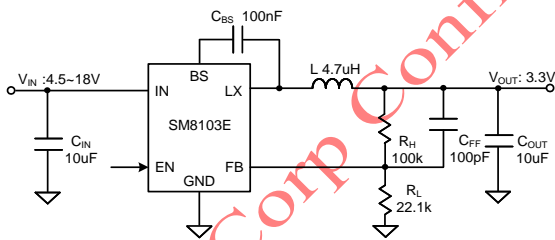

Figure1. Schematic Diagram

Inductor and C_{OUT} Selection Table

V_{OUT} [V]	L [μH]	C_{OUT} [μF]		
		4.7	10	22
1.2	1.5			√
	2.2			☆
3.3	2.2		√	√
	4.7		☆	√
5	3.3		√	√
	6.8		☆	√

Note: '☆' means recommended for most applications.

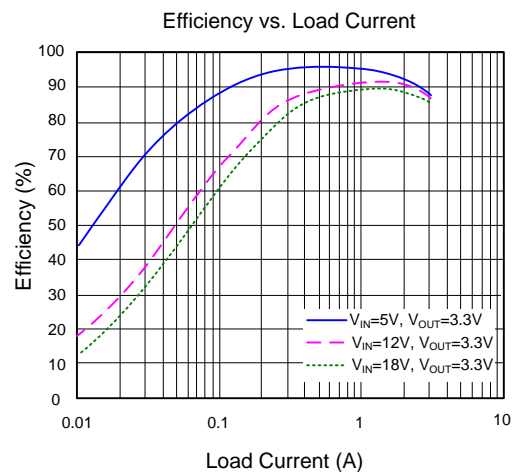
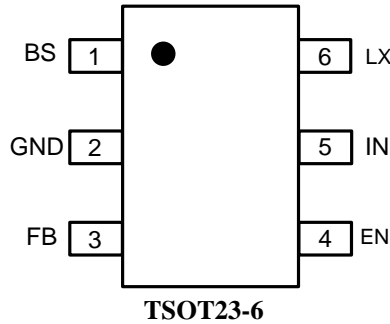

Figure2. Efficiency vs. Output Current

Pinout (top view)



TSOT23-6

Top mark: **J8xyz** (Device code: J8, x=year code, y=week code, z=lot number code)

Pin Name	Pin Number	Pin Description
BS	1	Boot-strap pin. Supply high side gate driver. Connect a 0.1 μ F ceramic capacitor between BS and LX pins.
GND	2	Power ground pin.
FB	3	Output feedback pin. Connect this pin to the center point of the output resistor divider (as shown in Figure 1) to program the output voltage: $V_{OUT}=0.6 \times (1+R_H/R_L)$.
EN	4	Enable control. Pull high to turn on. Do not leave this pin floating.
IN	5	Input pin. Decouple this pin to GND pin with at least a 10 μ F ceramic capacitor.
LX	6	Inductor pin. Connect this pin to the switching node of inductor.

Block Diagram

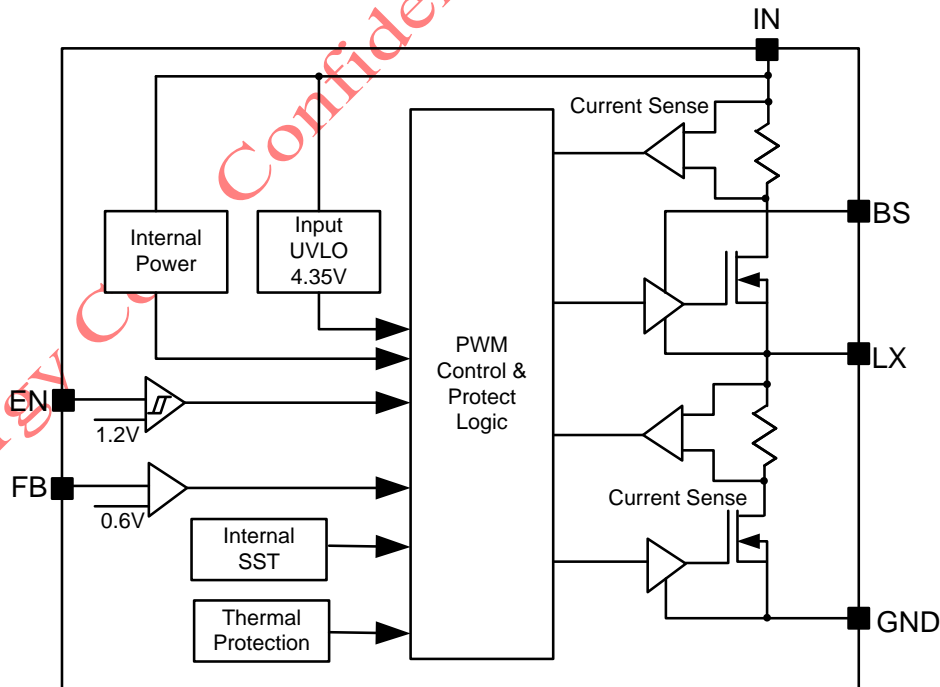

Figure2. Block Diagram



Absolute Maximum Ratings (Note 1)

Supply Input Voltage	-----	-0.3V to 19V
LX, EN Voltage	-----	-0.3V to $V_{IN} + 0.3V$
FB, BS-LX Voltage	-----	-0.3V to 4V
Power Dissipation, P_D @ $T_A = 25\text{ }^\circ\text{C}$ TSOT23-6,	-----	1.5W
Package Thermal Resistance (Note 2)		
θ_{JA}	-----	66 $^\circ\text{C/W}$
θ_{JC}	-----	15 $^\circ\text{C/W}$
Junction Temperature Range	-----	-40 $^\circ\text{C}$ to 150 $^\circ\text{C}$
Lead Temperature (Soldering, 10 sec.)	-----	260 $^\circ\text{C}$
Storage Temperature Range	-----	-65 $^\circ\text{C}$ to 150 $^\circ\text{C}$
Dynamic LX Voltage in 10ns Duration (Note3)	-----	IN+3V to GND-5V

Recommended Operating Conditions (Note 3)

Supply Input Voltage	-----	4.5V to 18V
Junction Temperature Range	-----	-40 $^\circ\text{C}$ to 125 $^\circ\text{C}$
Ambient Temperature Range	-----	-40 $^\circ\text{C}$ to 85 $^\circ\text{C}$

Silergy Corp Confidential Prepared for

Electrical Characteristics

($V_{IN} = 12V$, $V_{OUT} = 3.3V$, $L = 4.7 \mu H$, $C_{OUT} = 10 \mu F$, $T_A = 25 \text{ }^\circ C$, $I_{OUT} = 1A$ unless otherwise specified)

Parameter	Symbol	Test Conditions	Min	Typ	Max	Unit
Input Voltage Range	V_{IN}		4.5		18	V
Input UVLO Threshold	V_{UVLO}				4.35	V
Input UVLO Hysteresis	V_{HYS}			0.3		V
Shutdown Current	I_{SHDN}	EN=0		5	10	μA
Feedback Reference Voltage	V_{REF}		588	600	612	mV
FB Input Current	I_{FB}	$V_{FB}=3.3V$	-50		50	nA
Output Discharge Resistance	R_{DIS}			40		Ω
Top FET R_{ON}	$R_{DS(ON)1}$			90		$m\Omega$
Bottom FET R_{ON}	$R_{DS(ON)2}$			50		$m\Omega$
EN Rising Threshold	$V_{EN,R}$		1.08	1.2	1.32	V
EN Falling Threshold	$V_{EN,F}$		0.9	1.0	1.1	V
Min ON Time	$t_{ON,MIN}$			50		ns
Min OFF Time	$t_{OFF,MIN}$			200		ns
Turn On Delay	$t_{ON,DLY}$	from EN high to LX start switching		300		μs
Soft-start Time	t_{SS}	V_{OUT} from 0 to 100%		1		ms
Switching Frequency	F_{SW}	$V_{OUT}=3.3V$, CCM		500		kHz
Top FET Current Limit	$I_{LIM, TOP}$		4.5			A
Bottom FET Current Limit	$I_{LIM, BOT}$		3			A
Bottom FET Reverse Current Limit	$I_{LIM, RVS}$		1.3			A
Output Under Voltage Protection Threshold	V_{UVP}			33%		V_{REF}
Output UVP Delay	$t_{UVP, DLY}$			100		μs
UVP Hiccup On Time	$t_{UVP, ON}$			2		ms
UVP Hiccup Off Time	$t_{UVP, OFF}$			6		ms
Thermal Shutdown Temperature	T_{SD}			150		$^\circ C$
Thermal Shutdown Hysteresis	T_{HYS}			15		$^\circ C$

Note 1: Stresses beyond the “Absolute Maximum Ratings” may cause permanent damage to the device. These are stress ratings only. Functional operation of the device at these or any other conditions beyond those indicated in the operational sections of the specification is not implied. Exposure to absolute maximum rating conditions for extended periods may affect device reliability.

Note 2: θ_{JA} is measured in the natural convection at $T_A = 25 \text{ }^\circ C$ on a 2OZ two-layer Silergy evaluation board. Paddle of TSOT23-6 package is the case position for SM8103E θ_{JC} measurement.

Note 3: The device is not guaranteed to function outside its operating conditions.

TSOT23-6 Package Outline & PCB Layout

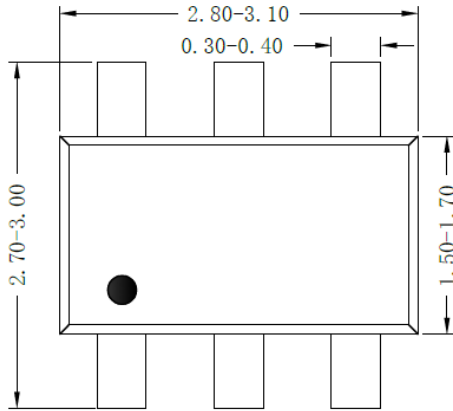

Top view

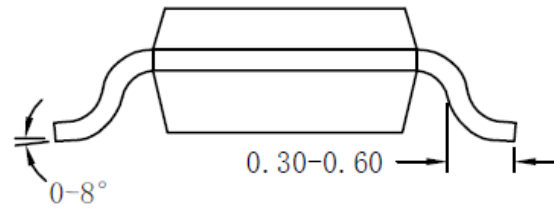

Side view

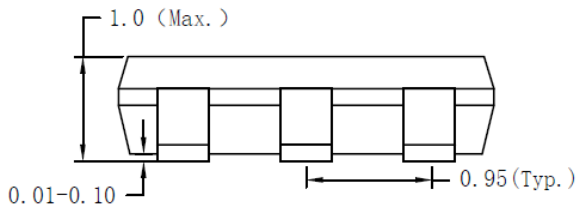

Front view

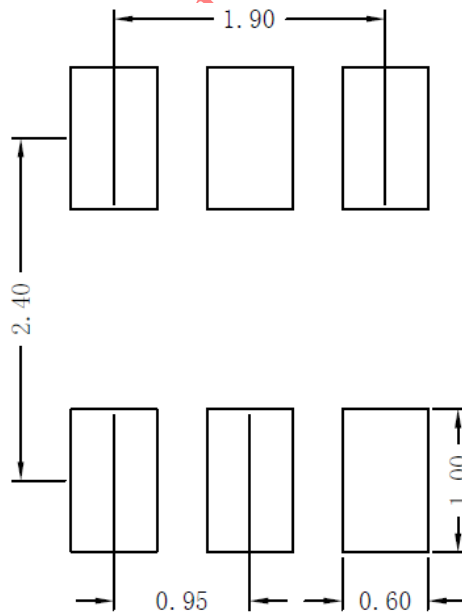

Recommended Pad Layout

Notes: All dimension in millimeter and exclude mold flash & metal burr.

Taping & Reel Specification

1. Taping orientation

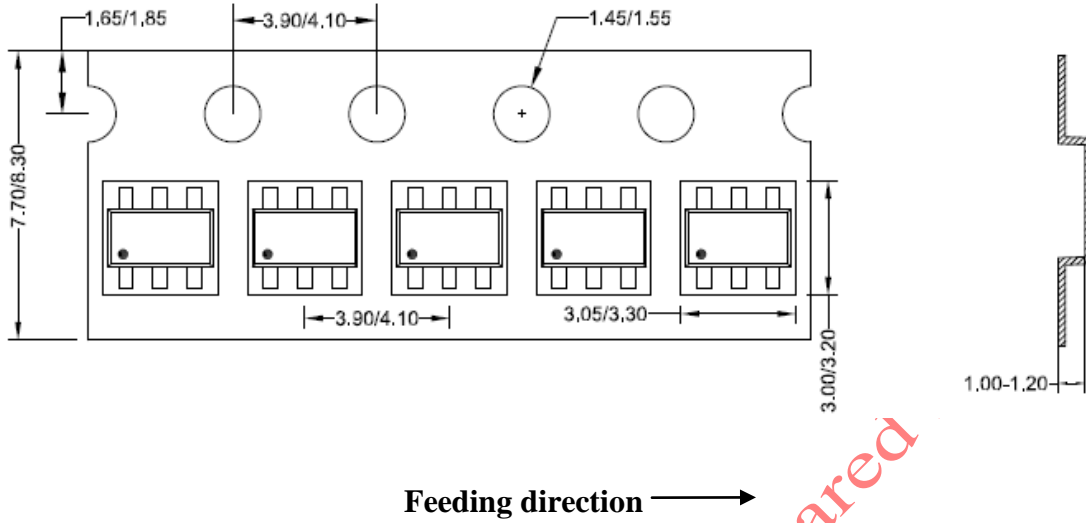

2. Carrier Tape & Reel specification for packages

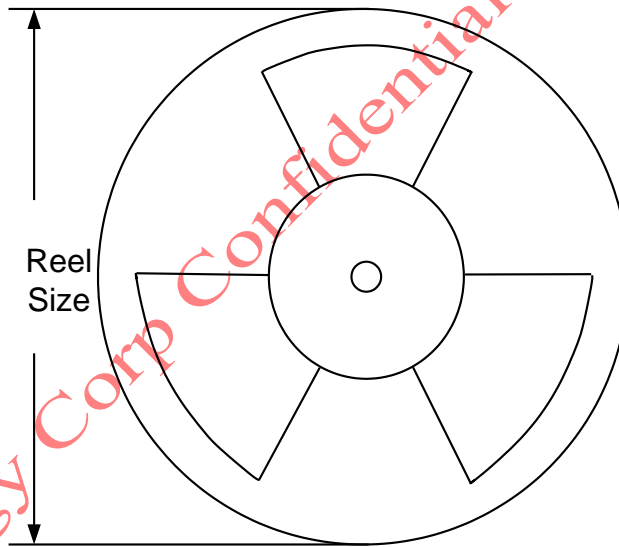

Package types	Tape width (mm)	Pocket pitch(mm)	Reel size (Inch)	Trailer length(mm)	Leader length (mm)	Qty per reel
TSOT23-6	8	4	7"	400	160	3000

3. Others: NA