

## P8SMB Transient Voltage Suppressor Diode Series

### General Information

The P8SMB series is designed to protect voltage sensitive components from high voltage, high energy transients. They have excellent clamping capability, high surge capability, low zener impedance and fast response time. The P8SMB series is supplied in YINT Semiconductor's exclusive ,cost-effective, highly reliable and is ideally suited for use in communication systems, automotive, numerical controls , process controls, medical equipment, business machines, power supplies and many other industrial/consumer Applications.



Molded plastic  
glass passivated junction.

### Features

- Case: DO-214AA/SMB
- For surface mounted applications in order to optimize board space.
- Polarity: Color band denoted positive end (cathode) except Bidirectional.
- Typical failure mode is short from over-specified voltage or current
- High Temperature soldering:260°C/10 seconds at terminals.
- Terminal: Solder plated, solderable per MIL-STD-750,Method 2026.

### Applications

TVS devices are ideal for the protection of I/O Interfaces, V<sub>CC</sub> bus and other vulnerable circuits used in Telecom, Computer, Industrial and Consumer electronic applications.

### Electrical Characteristics (@ TA = 25° C Unless Otherwise Noted)

Parameter	Symbol	Value	Unit
Minimum Peak Pulse Power Dissipation (T <sub>p</sub> = 1 ms) (note1 note 2)	P <sub>PK</sub>	800	Watts
Peak Forward Surge Current 8.3 ms Single Half Sine Wave Superimposed on Rated Load (JEDEC Method) (Note 3)	I <sub>FSM</sub>	100	Amps
Steady State Power Dissipation @ TL = 75 °C	P <sub>M(AV)</sub>	5.0	Watts
Maximum Instantaneous Forward Voltage @ I <sub>PP</sub> = 50 A (For Unidirectional Units Only)(note4 note 5)	V <sub>F</sub>	3.5/5	Volts
Operating Temperature Range	T <sub>J</sub>	-55 to +150	°C
Storage Temperature Range	T <sub>STG</sub>	-55 to +175	°C

#### NOTES:

1. Non-repetitive current pulse, per Pulse Waveform graph and derated above T<sub>A</sub> = 25 °C per Pulse Derating Curve.
2. Thermal Resistance Junction to Lead.
3. 8.3 ms Single Half-Sine Wave duty cycle = 4 pulses maximum per minute (unidirectional units only).
4. Single Phase, Half Wave, 60 Hz, resistive or inductive load. For capacitive load, derate current by 20 %.
5. V<sub>F</sub><3.5V for V<sub>BR</sub>< 200V and V<sub>F</sub> <5.0V for V<sub>BR</sub>> 201V.

**Electrical Characteristics (TA = 25 ° C unless otherwise noted)**

Part Number (Bi)	Part Number (Uni)	Reverse Stand off Voltage $V_R$ (Volts)	Breakdown Voltage $V_{BR}$ (Volts)@ $I_T$		Test Current $I_T$ (mA)	Maximum Reverse Leakage $I_R@ V_R$ ( $\mu$ A)	Maximum Peak Pulse Current $I_{pp}$ (A)	Maximum Clamping Voltage $V_C@ I_{pp}$ (V)
			Min .V	Max .V				
P8SMB5.0CA	P8SMB5.0A	5.0	6.4	7.25	10	800	86.96	9.2
P8SMB6.0CA	P8SMB6.0A	6.0	6.67	7.67	10	800	77.67	10.3
P8SMB 6.5CA	P8SMB 6.5A	6.5	7.22	8.30	10	500	71.43	11.2
P8SMB7.0CA	P8SMB7.0 A	7.0	7.78	8.95	10	200	66.67	12.0
P8SMB 7.5CA	P8SMB 7.5A	7.5	8.33	9.58	1	100	62.02	12.9
P8SMB 8.0CA	P8SMB 8.0A	8.0	8.89	10.23	1	50	58.82	13.6
P8SMB8.5CA	P8SMB8.5 A	8.5	9.44	10.82	1	20	55.56	14.4
P8SMB9.0CA	P8SMB9.0 A	9.0	10.00	11.50	1	10	51.95	15.4
P8SMB10CA	P8SMB10A	10.0	11.1	12.3	1	10	47.06	17.0
P8SMB11CA	P8SMB11A	11.0	12.20	14.00	1	5	43.96	18.2
P8SMB12CA	P8SMB12A	12.0	13.3	14.7	1	5	40.20	19.9
P8SMB13CA	P8SMB13A	13.0	14.40	16.50	1	5	37.21	21.5
P8SMB14CA	P8SMB14A	14.0	15.60	17.2	1	5	34.48	23.2
P8SMB15CA	P8SMB15A	15.0	16.70	19.20	1	5	32.79	24.4
P8SMB16CA	P8SMB16A	16.0	17.8	19.7	1	5	30.77	26.0
P8SMB17CA	P8SMB17A	17.0	18.90	21.70	1	5	28.99	27.6
P8SMB18CA	P8SMB18A	18.0	20.00	23.30	1	5	27.40	29.2
P8SMB20CA	P8SMB20A	20.0	22.20	25.50	1	5	24.69	32.4
P8SMB22CA	P8SMB22A	22.0	24.40	28.00	1	5	22.54	35.5
P8SMB24CA	P8SMB24A	24.0	26.70	30.70	1	5	20.57	38.9
P8SMB26CA	P8SMB26A	26.0	28.90	33.20	1	5	19.00	42.1
P8SMB28CA	P8SMB28A	28.0	31.10	35.80	1	5	17.62	45.4
P8SMB30CA	P8SMB30A	30.0	33.30	38.30	1	5	16.53	48.4
P8SMB33CA	P8SMB33A	33.0	36.70	42.20	1	5	15.01	53.3
P8SMB36CA	P8SMB36A	36.0	40.00	46.00	1	5	13.77	58.1
P8SMB40CA	P8SMB40A	40.0	44.40	51.10	1	5	12.40	64.5
P8SMB43CA	P8SMB43A	43.0	47.80	52.80	1	5	11.53	69.4
P8SMB45CA	P8SMB45A	45.0	50.00	57.50	1	5	11.00	72.7
P8SMB48CA	P8SMB48A	48.0	53.3	58.9	1	5	10.34	77.4
P8SMB51CA	P8SMB51A	51.0	56.70	65.20	1	5	9.71	82.4
P8SMB54CA	P8SMB54A	54.0	60.0	66.3	1	5	9.18	87.1
P8SMB58CA	P8SMB58A	58.0	64.40	74.10	1	5	8.55	93.6
P8SMB60CA	P8SMB60A	60.0	66.7	73.7	1	5	8.26	96.8
P8SMB64CA	P8SMB64A	64.0	71.10	81.80	1	5	7.77	103.0
P8SMB70CA	P8SMB70A	70.0	77.80	89.50	1	5	7.08	113.0
P8SMB75CA	P8SMB75A	75.0	83.3	92.1	1	5	6.61	121.0

Part Number (Bi)	Part Number (Uni)	Reverse Stand off Voltage $V_R$ (Volts)	Breakdown Voltage $V_{BR}$ (Volts)@ $I_T$		Test Current $I_T$ (mA)	Maximum Reverse Leakage $I_R$ @ $V_R$ ( $\mu$ A)	Maximum Peak Pulse Current $I_{pp}$ (A)	Maximum Clamping Voltage $V_C$ @ $I_{pp}$ (V)
			Min .V	Max .V				
P8SMB78CA	P8SMB78A	78.0	86.70	99.70	1	5	6.35	126.0
P8SMB85CA	P8SMB85A	85.0	94.40	108.20	1	5	5.84	137.0
P8SMB90CA	P8SMB90A	90.0	100.0	111.0	1	5	5.48	146.0
P8SMB100CA	P8SMB100A	100.0	110.00	128.00	1	5	4.94	162.0
P8SMB110CA	P8SMB110A	110.0	122.00	140.50	1	5	4.52	177.0
P8SMB120CA	P8SMB120A	120.0	133.00	147.00	1	5	4.15	193.0
P8SMB130CA	P8SMB130A	130.0	144.00	165.50	1	5	3.83	209.0
P8SMB150CA	P8SMB150A	150.0	167.00	192.50	1	5	3.29	243.0
P8SMB160CA	P8SMB160A	160.0	178.00	197.00	1	5	3.09	259.0
P8SMB170CA	P8SMB170A	170.0	189.00	217.50	1	5	2.91	275.0
P8SMB180CA	P8SMB180A	180.0	201.00	222.00	1	5	2.74	292.0
P8SMB200CA	P8SMB200A	200.0	224.00	247.00	1	5	2.47	324.0
P8SMB220CA	P8SMB220A	220.0	246.00	272.00	1	5	2.25	356.0
P8SMB350CA	P8SMB350A	350	391	432	1	1	1.41	567

I-V Curve Characteristics

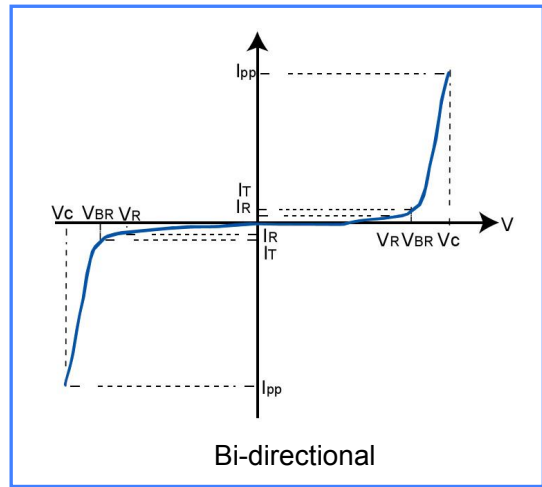
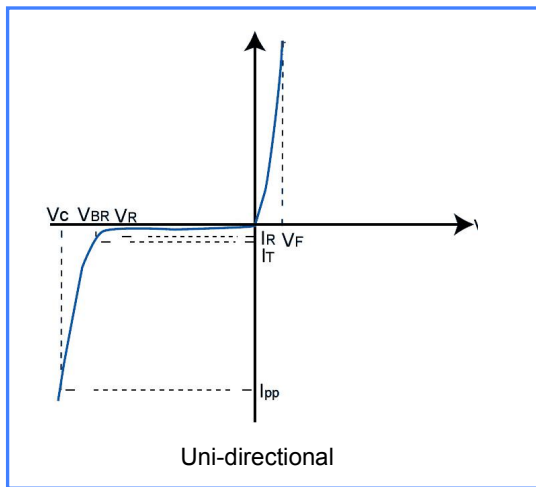

Symbol	Parameter
$I_{PP}$	Maximum Reverse Peak Pulse Current
$V_C$	Clamping Voltage @ $I_{PP}$
$V_{RWM}$	Working Peak Reverse Voltage
$I_R$	Maximum Reverse Leakage Current @ $V_{RWM}$
$V_{BR}$	Breakdown Voltage @ $I_T$
$I_T$	Test Current

Rating & Characteristic Curves

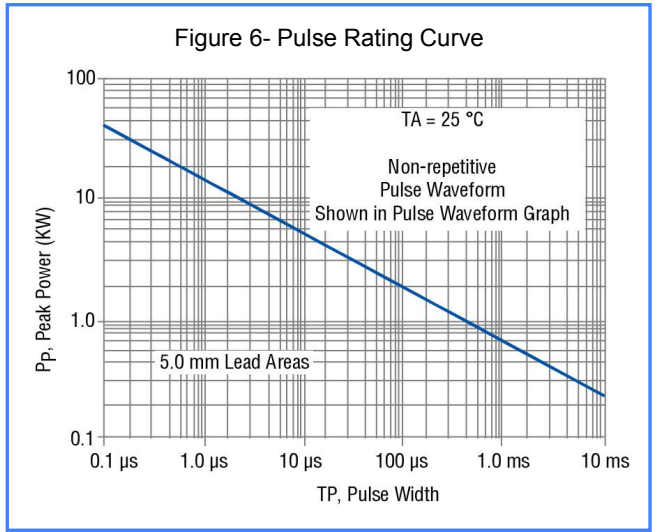
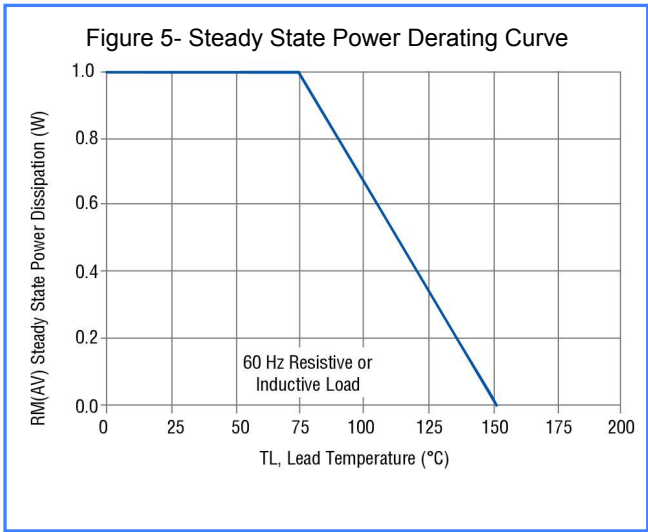
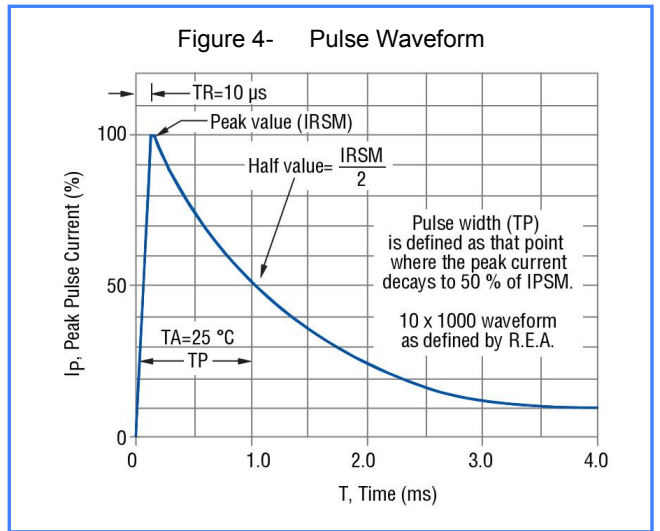
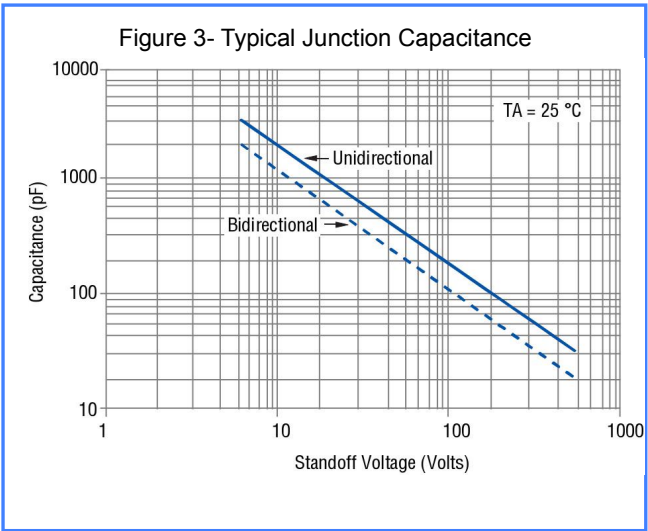
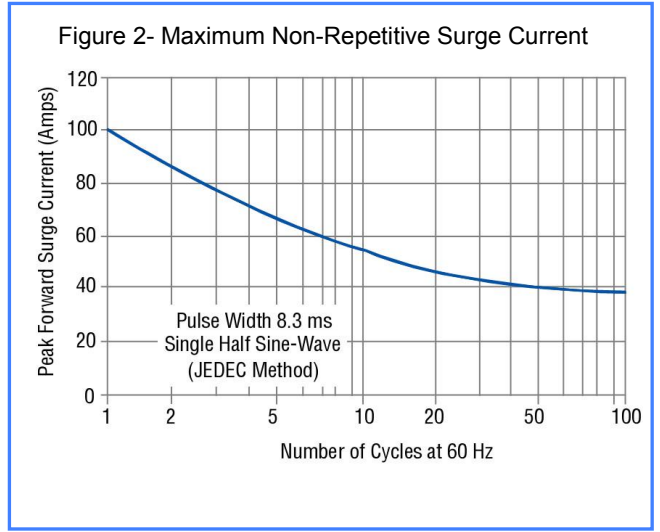
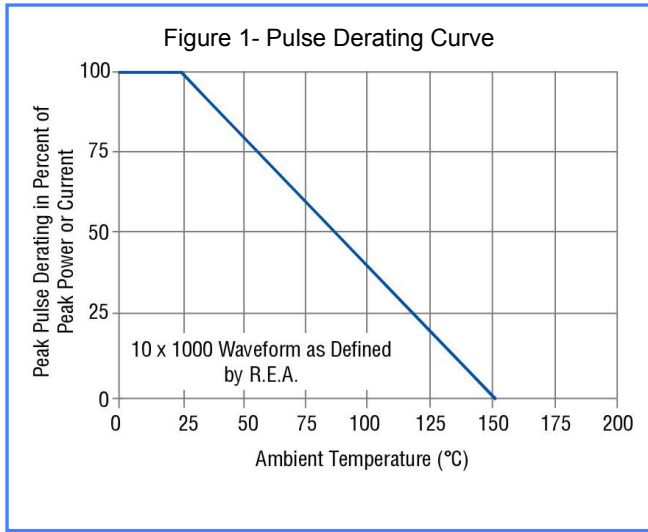

**PACKAGE OUTLINE DIMENSIONS in inches (millimeters)**

DO-214AA (SMB)

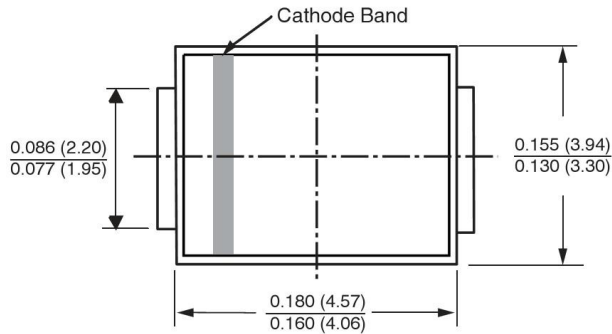

Mounting Pad Layout

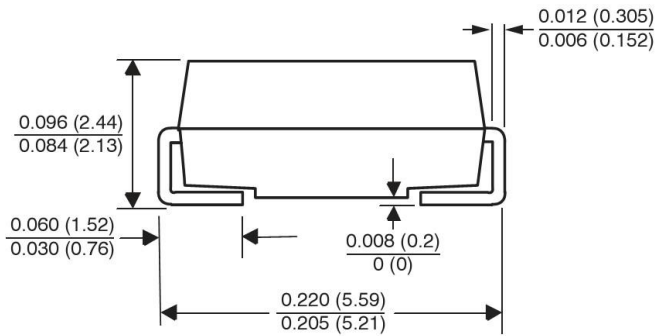
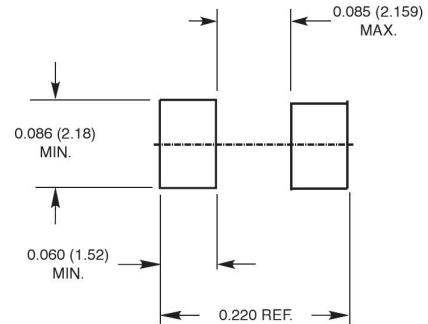

**Disclaimer**

Specifications are subject to change without notice.

The device characteristics and parameters in this data sheet can and do vary in different applications and actual device performance may vary over time.

Users should verify actual device performance in their specific applications.